

Appendix A

SEPA CHECKLIST

SEPA ENVIRONMENTAL CHECKLIST

Purpose of checklist:

Governmental agencies use this checklist to help determine whether the environmental impacts of your proposal are significant. This information is also helpful to determine if available avoidance, minimization or compensatory mitigation measures will address the probable significant impacts or if an environmental impact statement will be prepared to further analyze the proposal.

Instructions for applicants:

This environmental checklist asks you to describe some basic information about your proposal. Please answer each question accurately and carefully, to the best of your knowledge. You may need to consult with an agency specialist or private consultant for some questions. You may use "not applicable" or "does not apply" only when you can explain why it does not apply and not when the answer is unknown. You may also attach or incorporate by reference additional studies reports. Complete and accurate answers to these questions often avoid delays with the SEPA process as well as later in the decision-making process.

The checklist questions apply to all parts of your proposal, even if you plan to do them over a period of time or on different parcels of land. Attach any additional information that will help describe your proposal or its environmental effects. The agency to which you submit this checklist may ask you to explain your answers or provide additional information reasonably related to determining if there may be significant adverse impact.

Instructions for Lead Agencies:

Please adjust the format of this template as needed. Additional information may be necessary to evaluate the existing environment, all interrelated aspects of the proposal and an analysis of adverse impacts. The checklist is considered the first but not necessarily the only source of information needed to make an adequate threshold determination. Once a threshold determination is made, the lead agency is responsible for the completeness and accuracy of the checklist and other supporting documents.

Use of checklist for nonproject proposals:

For nonproject proposals (such as ordinances, regulations, plans and programs), complete the applicable parts of sections A and B plus the [SUPPLEMENTAL SHEET FOR NONPROJECT ACTIONS \(part D\)](#). Please completely answer all questions that apply and note that the words "project," "applicant," and "property or site" should be read as "proposal," "proponent," and "affected geographic area," respectively. The lead agency may exclude (for non-projects) questions in Part B - Environmental Elements –that do not contribute meaningfully to the analysis of the proposal.

A. Background [\[HELP\]](#)

1. Name of proposed project, if applicable: City of Renton 2021 Long Range Wastewater Management Plan
2. Name of applicant: **City of Renton – Utility Systems Division**

3. Address and phone number of applicant and contact person:

**Ann Fowler, CIP Project Manager, Wastewater Utility
1055 S Grady Way, Renton, WA 98057
425-430-7211
afowler@rentonwa.gov**

4. Date checklist prepared: **April 29, 2021**

5. Agency requesting checklist: **City of Renton**

6. Proposed timing or schedule (including phasing, if applicable):

The City of Renton 2021 Long Range Wastewater Management Plan is scheduled for adoption in 2021.

7. Do you have any plans for future additions, expansion, or further activity related to or connected with this proposal? If yes, explain.

No. This Plan lists capital improvement projects planned by the City within the next 10 years and long-term projects over the next 20 years. Proposed locations are shown in the Plan.

8. List any environmental information you know about that has been prepared, or will be prepared, directly related to this proposal.

Depending upon the scope of the projects proposed in the Plan, an individual environmental checklist and threshold determination would be completed as specified projects are proposed for construction.

9. Do you know whether applications are pending for governmental approvals of other proposals directly affecting the property covered by your proposal? If yes, explain.

At this time, there are no known pending applications for general applicability related to the area covered by the sewer system. There may be applications pending related to improvements to the sewer system such as various on-going plats and developer extensions occurring within the sewer service area. The City plans to adopt the capital improvement plan outlined in this document as part of the City's 10-year capital improvements plan.

10. List any government approvals or permits that will be needed for your proposal, if known.

The 2021 Long-Range Wastewater Management Plan will need to be approved by the Renton City Council and the Washington State Department of Ecology. The King County Utilities Technical Review Committee (UTRC) will review the plan and make recommendations to the Executive and County Council as to the consistency of such

items with adopted county policies and codes. King County will review and approve franchises to allow the construction of sewer facilities in county rights-of-way.

11. Give brief, complete description of your proposal, including the proposed uses and the size of the project and site. There are several questions later in this checklist that ask you to describe certain aspects of your proposal. You do not need to repeat those answers on this page. (Lead agencies may modify this form to include additional specific information on project description.)

The 2021 Long-Range Wastewater Management Plan (LRWWMP) addresses policies, criteria, assumptions and recommendations for the City's planning area. The major purpose of the Plan is to provide a long range plan for facility improvements necessary to serve the estimated population at saturation. The Plan addresses facility reliability, public health, groundwater and environmental protection, operation and maintenance, and financing issues. The plan also addresses the need to expand Renton's sewer service area into its Urban Growth Area as the appropriate provider of the urban service per the King County Countywide Planning Policies.

This checklist does not address the specific projects addressed in the five year capital improvement program. This is a programmatic checklist and does not address any site specific conditions. These conditions as well as the associated impacts will be discussed in the SEPA reviews of each project.

12. Location of the proposal. Give sufficient information for a person to understand the precise location of your proposed project, including a street address, if any, and section, township, and range, if known. If a proposal would occur over a range of area, provide the range or boundaries of the site(s). Provide a legal description, site plan, vicinity map, and topographic map, if reasonably available. While you should submit any plans required by the agency, you are not required to duplicate maps or detailed plans submitted with any permit applications related to this checklist.

The area covered by this comprehensive sewer system plan is the sewer service area as shown in Figure 2.1 of the LRWWMP. Renton has entered into boundary agreements with most of the sewer service providers adjacent to the City. These service boundaries are established and are not generally altered by annexations.

B. Environmental Elements [\[HELP\]](#)

1. **Earth** [\[help\]](#)

a. General description of the site:

(circle one) Flat rolling hilly, steep slopes, mountainous, other _____

The sewer service area includes steep slopes, several hills, a plateau, and river valley areas.

- b. What is the steepest slope on the site (approximate percent slope)?

The slopes vary from flat (zero percent) to very steep (over 40 percent). Steep slopes exist along the Maple Valley Highway to the north and south of the Cedar River Valley (southern edge of Renton Highlands; northern edge of Scenic Hill and Rolling Hills), along the eastern side of I-405 (eastern edge of the Renton Highlands), along the southern (SR 900) and eastern (Rainier Ave N) edges of Renton West Hill, along the western (SR 167) and northern (I-405) edges of Talbot Hill and the western edge (I-405) of Scenic Hill.

- c. What general types of soils are found on the site (for example, clay, sand, gravel, peat, muck)? If you know the classification of agricultural soils, specify them and note any agricultural land of long-term commercial significance and whether the proposal results in removing any of these soils.

According to the USDA's Web Soil Survey, the main soil types within the water service area include: Alderwood gravelly sandy loam, Alderwood and Kitsap soils, Arents-Alderwood material, and Indianola loamy sand. Alderwood gravelly sandy loam makes up over 30% of the water service area and is considered prime farmland. Using engineering classifications: there is a wide variety of highly variable glacial deposits in the water service area that include clay, silt, sand, gravel, cobbles, and boulders. In the river valley areas, there is a variety of modern alluvium and undifferentiated deltaic deposits. Adoption of the LRWWMP will not itself result in the removal of agricultural soil. Specific projects that are subject to environmental review will be evaluated for their impact to agricultural soils prior to implementation.

- d. Are there surface indications or history of unstable soils in the immediate vicinity? If so, describe.

Within the City, there are areas of unstable soils including steep slopes and historic coal mines. Some alluvial deposits in the Cedar River Valley and old Black River Valley may be subject to liquefaction during seismic events. Sensitive areas are mapped by the City and are subject to regulation under Renton Municipal Code Title IV, Development Regulations. Specific projects that are subject to environmental review will be evaluated for their soil conditions prior to implementation.

- e. Describe the purpose, type, total area, and approximate quantities and total affected area of any filling, excavation, and grading proposed. Indicate source of fill.

N/A, non-project action. However, the sewer system construction projects identified in the LRWWMP will require excavation and grading of an undetermined quantity of material. Specific projects will be subject to individual environmental review before implementation.

- f. Could erosion occur as a result of clearing, construction, or use? If so, generally describe.

N/A, non-project action. Adoption of the LRWWMP will not itself result in the clearing, construction, or use of soils, however, the Plan's programs and projects may result in erosion from construction. Specific projects that are subject to environmental review will be evaluated for erosion potential prior to implementation.

- g. About what percent of the site will be covered with impervious surfaces after project construction (for example, asphalt or buildings)?

N/A, non-project action. Specific projects will be subject to individual environmental review before implementation.

- h. Proposed measures to reduce or control erosion, or other impacts to the earth, if any:

N/A, non-project action. Where applicable, best management practices, along with erosion and sedimentation control measures, will be used in all areas of potential erosion. Specific projects will be subject to individual environmental review before implementation.

2. Air [\[help\]](#)

- a. What types of emissions to the air would result from the proposal during construction, operation, and maintenance when the project is completed? If any, generally describe and give approximate quantities if known.

N/A, non-project action. Adoption of the LRWWMP will not itself result in air emissions, however, the Plan's programs and projects may be a source of emissions from construction activity and increased usage of generators during maintenance, testing, and power outages events. Specific projects that are subject to environmental review will be evaluated for air emissions potential prior to implementation.

- b. Are there any off-site sources of emissions or odor that may affect your proposal? If so, generally describe.

N/A, non-project action. Specific projects that are subject to environmental review will be evaluated for off-site sources of emissions prior to implementation.

- c. Proposed measures to reduce or control emissions or other impacts to air, if any:

N/A, non-project action. However, standard emissions controls for construction equipment will be utilized during construction of projects recommended by this Plan. Specific projects that are subject to environmental review will be evaluated for their potential impact and corresponding mitigation measures prior to implementation.

3. Water [\[help\]](#)

- a. Surface Water: [\[help\]](#)

- 1) Is there any surface water body on or in the immediate vicinity of the site (including year-round and seasonal streams, saltwater, lakes, ponds, wetlands)? If yes, describe type and provide names. If appropriate, state what stream or river it flows into.

There are multiple surface water bodies within the sewer system area. The northwest boundary of the sewer service area is the shoreline of Lake Washington. The rivers and streams that run through the sewer service area

include the Cedar River, Green River, May Creek, and Springbrook Creek. The Cedar River is tributary to Lake Washington and the Green River is a tributary to Puget Sound. May Creek flows into Lake Washington and Springbrook Creek flows into the Green River. All water bodies and wetland boundaries are cataloged in the City's GIS (COR Maps).

- 2) Will the project require any work over, in, or adjacent to (within 200 feet) the described waters? If yes, please describe and attach available plans.

N/A, non-project action. However, the Plan's programs and projects may require work within 200 feet of surface water bodies. These projects will be subject to individual review and compliance with the City's Shoreline Master Program.

- 3) Estimate the amount of fill and dredge material that would be placed in or removed from surface water or wetlands and indicate the area of the site that would be affected. Indicate the source of fill material.

N/A, non-project action. Adoption of the LRWWMP will not itself result in the direct alteration of the environment, however, the Plan's programs and projects may result in the addition or removal of fill and dredge material. The potential impacts of these actions are currently unknown. Projects that are subject to environmental review will be evaluated for potential impacts and corresponding mitigation measures prior to implementation.

- 4) Will the proposal require surface water withdrawals or diversions? Give general description, purpose, and approximate quantities if known.

N/A, non-project action. Adoption of the LRWWMP will not itself result in the withdrawal or diversion of surface water. Projects that are subject to environmental review will be evaluated for potential impacts and corresponding mitigation measures prior to implementation.

- 5) Does the proposal lie within a 100-year floodplain? If so, note location on the site plan.

N/A, non-project action. However, some portions of the City are within or adjacent to 100-year floodplains. Projects that are subject to environmental review will identify floodplain boundaries prior to implementation.

- 6) Does the proposal involve any discharges of waste materials to surface waters? If so, describe the type of waste and anticipated volume of discharge.

N/A, non-project action. However, no waste material will be discharged into surface waters during construction of projects recommended by this Plan. Projects that are subject to environmental review will identify discharge plans prior to implementation.

b. Ground Water: [\[help\]](#)

- 1) Will groundwater be withdrawn from a well for drinking water or other purposes? If so, give a general description of the well, proposed uses and approximate quantities withdrawn from the well. Will water be discharged to groundwater? Give general description, purpose, and approximate quantities if known.

N/A, non-project action. Adoption of the LRWWMP will not itself result in the withdrawal of groundwater.

- 2) Describe waste material that will be discharged into the ground from septic tanks or other sources, if any (for example: Domestic sewage; industrial, containing the following chemicals. . . ; agricultural; etc.). Describe the general size of the system, the number of such systems, the number of houses to be served (if applicable), or the number of animals or humans the system(s) are expected to serve.

N/A, non-project action. However, no waste material will be discharged into the ground during projects recommended by this Plan. Projects that are subject to environmental review will identify discharge plans prior to implementation.

c. Water runoff (including stormwater):

- 1) Describe the source of runoff (including storm water) and method of collection and disposal, if any (include quantities, if known). Where will this water flow? Will this water flow into other waters? If so, describe.

N/A, non-project action. Adoption of the LRWWMP will not itself result in runoff. Projects that are subject to environmental review will be evaluated for potential impacts and corresponding mitigation measures prior to implementation.

- 2) Could waste materials enter ground or surface waters? If so, generally describe.

N/A, non-project action. Adoption of the LRWWMP will not itself result in waste materials entering ground or surface waters. Projects that are subject to environmental review will be evaluated for potential impacts and corresponding mitigation measures prior to implementation.

- 3) Does the proposal alter or otherwise affect drainage patterns in the vicinity of the site? If so, describe.

N/A, non-project action. Adoption of the LRWWMP will not itself result in any such impacts.

d. Proposed measures to reduce or control surface, ground, and runoff water, and drainage pattern impacts, if any:

N/A, non-project action. Adoption of the LRWWMP will not itself result in any such impacts. Projects that are subject to environmental review will be evaluated for

potential impacts and their corresponding reduction and control measures prior to implementation.

4. **Plants** [\[help\]](#)

a. Check the types of vegetation found on the site:

deciduous tree: alder, maple, aspen, other

evergreen tree: fir, cedar, pine, other

shrubs

grass

pasture

crop or grain

Orchards, vineyards or other permanent crops.

wet soil plants: cattail, buttercup, bullrush, skunk cabbage, other

water plants: water lily, eelgrass, milfoil, other

other types of vegetation

b. What kind and amount of vegetation will be removed or altered?

N/A, non-project action. Adoption of the LRWWMP will not itself result in the direct removal or alteration of vegetation, however, the Plan's programs and projects may result in these impacts. The potential impacts of these actions are currently unknown. Projects that are subject to environmental review will be evaluated for potential vegetation impacts and corresponding mitigation measures prior to implementation.

c. List threatened and endangered species known to be on or near the site.

N/A, non-project action. Specific projects that are subject to environmental review will be evaluated for their potential impact to threatened or endangered plant species on or near the site.

d. Proposed landscaping, use of native plants, or other measures to preserve or enhance vegetation on the site, if any:

N/A, non-project action. Specific projects that are subject to environmental review will be evaluated for vegetation plans before implementation.

e. List all noxious weeds and invasive species known to be on or near the site.

N/A, non-project action. Specific projects that are subject to environmental review will be evaluated for noxious and invasive plant species on or near the site before plan implementation.

5. **Animals** [\[help\]](#)

a. List any birds and other animals which have been observed on or near the site or are known to be on or near the site.

N/A, non-project action. Many of the following birds and animals could be present within the water service area. Specific projects will be subject to individual environmental review prior to implementation.

Examples include:

Birds: hawk, heron, eagle, songbirds other: gulls

Mammals: deer, bear, elk, beaver other: possum, raccoon, rabbits, squirrels

Fish: bass, salmon, trout, herring, shellfish, other: _____

- b. List any threatened and endangered species known to be on or near the site.

According to the U.S. Fish and Wildlife Service, the following animals are listed as threatened within the water service area: bull trout (*Salvelinus confluentus*), marbled murrelet (*Brachyramphus marmoratus*), streaked horned lark (*Eremophila alpestris strigata*), and yellow-billed cuckoo (*Coccyzus americanus*). According NOAA, the City is within the critical habitat for Puget Sound ESU Chinook (*Oncorhynchus tshawytscha*) and Puget Sound DPS Steelhead (*Oncorhynchus mykiss*). Specific projects that are subject to environmental review will be evaluated for their potential impact to threatened or endangered wildlife species on or near the site.

- c. Is the site part of a migration route? If so, explain.

N/A, non-project action. However, the entire state of Washington is within the Pacific flyway and two rivers within the sewer service area (Cedar and Green Rivers) are spawning routes for salmon and steelhead trout. Specific projects will be subject to individual environmental review prior to implementation.

- d. Proposed measures to preserve or enhance wildlife, if any:

N/A, non-project action. Projects that are subject to environmental review will be evaluated for potential impacts to wildlife and their corresponding preservation or enhancement measures prior to implementation.

- e. List any invasive animal species known to be on or near the site.

N/A, non-project action. Specific projects that are subject to environmental review will be evaluated for invasive animal species on or near the site prior to implementation.

6. Energy and Natural Resources [\[help\]](#)

- a. What kinds of energy (electric, natural gas, oil, wood stove, solar) will be used to meet the completed project's energy needs? Describe whether it will be used for heating, manufacturing, etc.

N/A, non-project action. Adoption of the LRWWMP will not itself use energy. Specific projects that are subject to environmental review will be evaluated for energy and other natural resource uses prior to implementation.

- b. Would your project affect the potential use of solar energy by adjacent properties?
If so, generally describe.

N/A, non-project action. Adoption of the LRWWMP will not itself affect the use of solar energy. Specific projects that are subject to environmental review will be evaluated for effects on solar energy by adjacent properties prior to implementation.

- c. What kinds of energy conservation features are included in the plans of this proposal?
List other proposed measures to reduce or control energy impacts, if any:

N/A, non-project action. Adoption of the LRWWMP will not itself result in the direct reduction or control of energy impacts, however, the Plan's programs and projects may result in energy conservation features. Specific projects that are subject to environmental review will be evaluated for energy conservation features prior to implementation.

7. Environmental Health [\[help\]](#)

- a. Are there any environmental health hazards, including exposure to toxic chemicals, risk of fire and explosion, spill, or hazardous waste, that could occur as a result of this proposal?
If so, describe.

N/A, non-project action. Adoption of the LRWWMP will not itself result in direct environmental hazards, however, the potential impacts from the Plan's programs and projects are currently unknown. Specific projects that are subject to environmental review will be evaluated for potential environmental health hazards and corresponding mitigation measures prior to implementation.

- 1) Describe any known or possible contamination at the site from present or past uses.

N/A, non-project action. Specific projects that are subject to environmental review will be evaluated for known or possible contamination at the site prior to implementation.

- 2) Describe existing hazardous chemicals/conditions that might affect project development and design. This includes underground hazardous liquid and gas transmission pipelines located within the project area and in the vicinity.

N/A, non-project action. Specific projects that are subject to environmental review will be evaluated for existing hazardous chemicals or conditions at the site prior to implementation.

- 3) Describe any toxic or hazardous chemicals that might be stored, used, or produced during the project's development or construction, or at any time during the operating life of the project.

N/A, non-project action. Specific projects that are subject to environmental review will be evaluated for toxic or hazardous chemicals during the development, construction, or lifetime of the project prior to implementation.

- 4) Describe special emergency services that might be required.

N/A, non-project action. Adoption of the LRWWMP will not itself require emergency services, however, the potential impacts from the Plan's programs and projects are currently unknown. Specific projects that are subject to environmental review will be evaluated for special emergency services prior to implementation.

- 5) Proposed measures to reduce or control environmental health hazards, if any:

N/A, non-project action. Adoption of the LRWWMP will not itself require the reduction or control of environmental health hazards, however, the potential impacts from the Plan's programs and projects are currently unknown. Specific projects that are subject to environmental review will be evaluated for environmental health hazards and corresponding reduction or control measures prior to implementation.

b. Noise

- 1) What types of noise exist in the area which may affect your project (for example: traffic, equipment, operation, other)?

N/A, non-project action. Specific projects that are subject to environmental review will be evaluated for surrounding noise prior to implementation.

- 2) What types and levels of noise would be created by or associated with the project on a short-term or a long-term basis (for example: traffic, construction, operation, other)? Indicate what hours noise would come from the site.

N/A, non-project action. Adoption of the LRWWMP will not itself create any long-term or short-term noise, however, the potential impacts from the Plan's programs and projects are currently unknown. Specific projects that are subject to environmental review will be evaluated for potential project noise prior to implementation.

- 3) Proposed measures to reduce or control noise impacts, if any:

N/A, non-project action. Specific projects that are subject to environmental review will be evaluated for potential project noise and corresponding measures to reduce or control noise impacts prior to implementation.

8. Land and Shoreline Use [\[help\]](#)

- a. What is the current use of the site and adjacent properties? Will the proposal affect current land uses on nearby or adjacent properties? If so, describe.

The following land uses are present within the water service area: industrial, commercial, residential, public, park, and other land uses. Adoption of the LRWWMP will not itself affect any land use on nearby or adjacent properties, however, the potential impacts from the Plan's programs and projects are currently unknown. Specific projects that are subject to environmental review will be evaluated for individual land uses prior to implementation.

- b. Has the project site been used as working farmlands or working forest lands? If so, describe. How much agricultural or forest land of long-term commercial significance will be converted to other uses as a result of the proposal, if any? If resource lands have not been designated, how many acres in farmland or forest land tax status will be converted to nonfarm or nonforest use?

In the past, the City contained working farmlands as a small part of the economic base. Adoption of the LRWWMP will not itself convert any agricultural or forest land. Specific projects that are subject to environmental review will be evaluated for effects to working farm or forest land prior to implementation.

- 1) Will the proposal affect or be affected by surrounding working farm or forest land normal business operations, such as oversize equipment access, the application of pesticides, tilling, and harvesting? If so, how:

N/A, non-project action. Adoption of the LRWWMP will not itself affect or be affected by surrounding working farm or forest land, however, the potential impacts from the Plan's programs and projects are currently unknown. Specific projects that are subject to environmental review will be evaluated for affects by or affects to working farm or forest land prior to implementation.

- c. Describe any structures on the site.

There are many types of structures in the sewer service area including: industrial, commercial, residential, schools, hotels, and other common structures.

- d. Will any structures be demolished? If so, what?

N/A, non-project action. Adoption of the LRWWMP will not itself demolish any structures, however, the potential impacts from the Plan's programs and projects are currently unknown. Specific projects that are subject to environmental review will be evaluated for planned demolition prior to implementation.

e. What is the current zoning classification of the site?

The sewer service area encompasses a wide variety of zoning classifications including: resource conservation, residential, commercial, urban, and industrial areas.

f. What is the current comprehensive plan designation of the site?

The sewer service area encompasses multiple comprehensive plan land use designations including: residential low density, residential medium density, residential high density, commercial & mixed use, commercial office residential, and employment area.

g. If applicable, what is the current shoreline master program designation of the site?

The sewer service area encompasses multiple areas classified with shoreline designations including: natural, urban conservancy, single family residential, shoreline high-intensity, shoreline isolated high-intensity, and aquatic environments. Specific projects recommended by the Plan will be required to comply with the City's Shoreline Master Program.

h. Has any part of the site been classified as a critical area by the city or county? If so, specify.

The sewer service area encompasses multiple areas classified as critical areas. These include: flood hazard areas, seismic hazard areas, steep slopes, habitat conservation areas, streams, lakes, wellhead protection areas, and wetlands.

i. Approximately how many people would reside or work in the completed project?

The City's sewer system provided service to a full time residential and commercial population of approximately 113,792 in 2012, and is estimated to increase to 219,014 by 2040.

j. Approximately how many people would the completed project displace?

N/A, non-project action. Adoption of the LRWWMP will not itself displace any people. The potential impacts from the Plan's programs and projects are currently unknown, however, it is unlikely any project would lead to displacement. Specific projects that are subject to environmental review will be evaluated for displacement prior to implementation.

k. Proposed measures to avoid or reduce displacement impacts, if any:

N/A, non-project action. Specific projects that are subject to environmental review will be evaluated for displacement prior to implementation.

- L. Proposed measures to ensure the proposal is compatible with existing and projected land uses and plans, if any:

The City of Renton Long Range Wastewater Management Plan is written in accordance with all existing local, county, and state regulations including the City's Comprehensive Plan.

- m. Proposed measures to reduce or control impacts to agricultural and forest lands of long-term commercial significance, if any:

N/A, non-project action. Specific projects that are subject to environmental review will be evaluated for potential impacts to agricultural and forest lands, and their corresponding preservation or enhancement measures, prior to implementation.

9. Housing [\[help\]](#)

- a. Approximately how many units would be provided, if any? Indicate whether high, middle, or low-income housing.

N/A, non-project action. The adoption of the LRWWMP and its corresponding programs and projects are not intended to provide housing units.

- b. Approximately how many units, if any, would be eliminated? Indicate whether high, middle, or low-income housing.

N/A, non-project action. The adoption of the LRWWMP and its corresponding programs and projects are not intended to provide housing units.

- c. Proposed measures to reduce or control housing impacts, if any:

N/A, non-project action. The adoption of the LRWWMP and its corresponding programs and projects are not intended to provide housing units.

10. Aesthetics [\[help\]](#)

- a. What is the tallest height of any proposed structure(s), not including antennas; what is the principal exterior building material(s) proposed?

N/A, non-project action. Adoption of the LRWWMP will not itself result in a structure. Specific projects that are subject to environmental review will be evaluated for structure height and material prior to implementation.

- b. What views in the immediate vicinity would be altered or obstructed?

N/A, non-project action. Specific projects that are subject to environmental review will be evaluated for view alteration or obstruction prior to implementation.

- c. Proposed measures to reduce or control aesthetic impacts, if any:

N/A, non-project action. Specific projects that are subject to environmental review will be evaluated for their potential aesthetic impacts and corresponding mitigation measures prior to implementation.

11. Light and Glare [\[help\]](#)

- a. What type of light or glare will the proposal produce? What time of day would it mainly occur?

N/A, non-project action. Adoption of the LRWWMP will not itself result in light or glare. Specific projects that are subject to environmental review will be evaluated for potential light or glare prior to implementation.

- b. Could light or glare from the finished project be a safety hazard or interfere with views?

N/A, non-project action. Adoption of the LRWWMP will not itself result in light or glare. Specific projects that are subject to environmental review will be evaluated for potential light or glare prior to implementation.

- c. What existing off-site sources of light or glare may affect your proposal?

N/A, non-project action. Adoption of the LRWWMP itself will not be affected by existing off-site sources of light or glare. Specific projects that are subject to environmental review will be evaluated for existing off-site light or glare prior to implementation.

- d. Proposed measures to reduce or control light and glare impacts, if any:

N/A, non-project action. Adoption of the LRWWMP itself will not be affected by existing off-site sources of light or glare. Specific projects that are subject to environmental review will be evaluated for their potential light impacts and corresponding mitigation measures prior to implementation.

12. Recreation [\[help\]](#)

- a. What designated and informal recreational opportunities are in the immediate vicinity?

Within and near the sewer service area are numerous parks and recreational opportunities, including Maplewood Golf Course. There are also streams and rivers within the water service area that provide recreational opportunities.

b. Would the proposed project displace any existing recreational uses? If so, describe.

N/A, non-project action. Adoption of the LRWWMP will not itself displace any recreational uses.

c. Proposed measures to reduce or control impacts on recreation, including recreation opportunities to be provided by the project or applicant, if any:

N/A, non-project action. Specific projects that are subject to environmental review will be evaluated for their impacts on recreation and corresponding mitigation measures prior to implementation.

13. Historic and cultural preservation [\[help\]](#)

a. Are there any buildings, structures, or sites, located on or near the site that are over 45 years old listed in or eligible for listing in national, state, or local preservation registers ? If so, specifically describe.

N/A, non-project action. Adoption of the LRWWMP will not itself involve any historical buildings or sites. Specific projects that are subject to environmental review will be evaluated for their proximity to historical buildings or sites prior to implementation.

b. Are there any landmarks, features, or other evidence of Indian or historic use or occupation? This may include human burials or old cemeteries. Are there any material evidence, artifacts, or areas of cultural importance on or near the site? Please list any professional studies conducted at the site to identify such resources.

N/A, non-project action. Adoption of the LRWWMP will not itself involve any cultural resources. Specific projects that are subject to environmental review will be evaluated for their proximity to cultural resources prior to implementation.

c. Describe the methods used to assess the potential impacts to cultural and historic resources on or near the project site. Examples include consultation with tribes and the department of archeology and historic preservation, archaeological surveys, historic maps, GIS data, etc.

N/A, non-project action. Specific projects that are subject to environmental review will be evaluated for their impacts on historic sites and cultural resources on or near the project site.

d. Proposed measures to avoid, minimize, or compensate for loss, changes to, and disturbance to resources. Please include plans for the above and any permits that may be required.

N/A, non-project action. Specific projects that are subject to environmental review will be evaluated for their impacts on historic and cultural resources and corresponding mitigation measures prior to implementation.

14. **Transportation** [\[help\]](#)

- a. Identify public streets and highways serving the site or affected geographic area and describe proposed access to the existing street system. Show on site plans, if any.

Many streets and highways serve the Sewer System Plan area. Major highways passing through the city include: Interstate 405 and State Routes 167, 169, 515 and 900. Major arterials providing access to and from the city include Rainier Avenue, Benson Road, Carr Road, and Duvall Avenue.

- b. Is the site or affected geographic area currently served by public transit? If so, generally describe. If not, what is the approximate distance to the nearest transit stop?

Public transportation within the City includes bus and train services provided by Sound Transit and King County Metro. Specific projects that are subject to environmental review will be evaluated for their proximity to public transit prior to implementation.

- c. How many additional parking spaces would the completed project or non-project proposal have? How many would the project or proposal eliminate?

N/A, non-project action. Adoption of the LRWWMP will not itself impact any parking features. Specific projects that are subject to environmental review will be evaluated for their impacts to parking spaces and corresponding mitigation measures prior to implementation.

- d. Will the proposal require any new or improvements to existing roads, streets, pedestrian, bicycle or state transportation facilities, not including driveways? If so, generally describe (indicate whether public or private).

N/A, non-project action. Adoption of the LRWWMP will not itself require any new or improved transportation features. Specific projects that are subject to environmental review will be evaluated for their impacts to transportation prior to implementation.

- e. Will the project or proposal use (or occur in the immediate vicinity of) water, rail, or air transportation? If so, generally describe.

N/A, non-project action. The Plan's programs and projects may occur in the immediate vicinity of water, rail, or air transportation. Specific projects that are subject to environmental review will be evaluated for transportation prior to implementation.

- f. How many vehicular trips per day would be generated by the completed project or proposal? If known, indicate when peak volumes would occur and what percentage of the volume would be trucks (such as commercial and nonpassenger vehicles). What data or transportation models were used to make these estimates?

N/A, non-project action. Adoption of the LRWWMP will not itself affect the amount of vehicular trips per day in the area, however, the potential impacts from the Plan's programs and projects are currently unknown. Specific projects that are subject to environmental review will be evaluated for effects to transportation prior to implementation.

- g. Will the proposal interfere with, affect or be affected by the movement of agricultural and forest products on roads or streets in the area? If so, generally describe.

N/A, non-project action. The potential impacts from the Plan's programs and projects are currently unknown, however, it is unlikely any project would affect or be affected by the movement of agricultural or forest products. Specific projects that are subject to environmental review will be evaluated for the movement of products prior to implementation.

- h. Proposed measures to reduce or control transportation impacts, if any:

N/A, non-project action. Specific projects that are subject to environmental review will be evaluated for their impacts on transportation and corresponding mitigation measures prior to implementation.

15. Public Services [\[help\]](#)

- a. Would the project result in an increased need for public services (for example: fire protection, police protection, public transit, health care, schools, other)? If so, generally describe.

N/A, non-project action. The potential impacts from the Plan's programs and projects are currently unknown, however, it is unlikely any project would increase the need for public services. Specific projects that are subject to environmental review will be evaluated for public service needs prior to implementation.

- b. Proposed measures to reduce or control direct impacts on public services, if any.

N/A, non-project action. Specific projects that are subject to environmental review will be evaluated for their impacts on public services and corresponding mitigation measures prior to implementation.

16. Utilities [\[help\]](#)

- a. Circle utilities currently available at the site:

electricity, natural gas, water, refuse service, telephone, sanitary sewer, septic system,
other _____

- b. Describe the utilities that are proposed for the project, the utility providing the service, and the general construction activities on the site or in the immediate vicinity which might be needed.

The recommended repairs, replacements, improvements, or extensions to infrastructure in the LRWWMP are required to meet the level of service criteria set forth by local, county, and state governments. The infrastructure includes lift stations, sewer mains, and related appurtenances. Each specific recommended project, subject to environmental review, will be evaluated for its impacts prior to implementation.

C. Signature [\[HELP\]](#)

The above answers are true and complete to the best of my knowledge. I understand that the lead agency is relying on them to make its decision.

Signature:  _____

Name of signee Ann Fowler _____

Position and Agency/Organization CIP Project Manager/ City of Renton _____

Date Submitted: April 29, 2021

D. Supplemental sheet for nonproject actions [\[HELP\]](#)

(IT IS NOT NECESSARY to use this sheet for project actions)

Because these questions are very general, it may be helpful to read them in conjunction with the list of the elements of the environment.

When answering these questions, be aware of the extent the proposal, or the types of activities likely to result from the proposal, would affect the item at a greater intensity or at a faster rate than if the proposal were not implemented. Respond briefly and in general terms.

- 1. How would the proposal be likely to increase discharge to water; emissions to air; production, storage, or release of toxic or hazardous substances; or production of noise?

The Long Range Wastewater Management Plan will not itself increase discharge to water, emissions to air, hazardous substances, or production of noise, however, the Plan’s programs and projects have the potential for these effects. For example, projects recommended by the Plan that require construction may result in exhaust emissions, dust, and noise from construction equipment as well as temporary storage of hazardous materials. All hazardous materials storage within the Aquifer Protection Area will be required to comply with the Aquifer Protection Code in order to prevent contamination of the City’s main drinking water source. Specific projects that are subject to environmental review will be evaluated for potential impacts and corresponding mitigation measures prior to implementation.

Proposed measures to avoid or reduce such increases are:

For the LRWWMP adoption, there are no specific measures planned to reduce these impacts. Best management practices will be used to minimize impacts, in accordance with local, state, and federal laws, during the planning and construction of any applicable projects. Proposed projects will be reviewed and addressed on an individual basis by appropriate agencies prior to implementation.

2. How would the proposal be likely to affect plants, animals, fish, or marine life?

Adoption of the LRWWMP will not itself result in direct effects to plants, animals, fish, or marine life. It is not anticipated that any of the proposed projects within the Plan will have an impact upon vegetation or wildlife, however, there is potential for impacts to occur during construction efforts. Specific projects that are subject to environmental review will be evaluated for potential impacts to vegetation and wildlife and corresponding mitigation measures prior to implementation.

Proposed measures to protect or conserve plants, animals, fish, or marine life are:

Specific projects that are subject to environmental review will be evaluated for their potential impact to plants, animals, fish, and marine life. Potential impacts will be reported with corresponding mitigation measures to protect or conserve vegetation and wildlife. Proposed projects and mitigation measures will be reviewed and addressed on an individual basis by appropriate agencies prior to implementation.

3. How would the proposal be likely to deplete energy or natural resources?

Adoption of the LRWWMP will not itself result in the direct depletion of energy or natural resources. It is not anticipated that any of the proposed projects within the Plan will have a strong impact on energy or natural resources, however, some projects may require the use of energy resources. For example, the running or testing of water system facilities uses electricity and construction projects require fuel for equipment operation and delivery of materials. Specific projects that are subject to environmental review will be evaluated for potential impacts to energy resources and corresponding mitigation measures prior to implementation.

Proposed measures to protect or conserve energy and natural resources are:

For the LRWWMP adoption, best management practices will be used to minimize energy usage. For example, the sewer utility maximizes the potential for gravity flow in the sewer system whenever possible. Programs and projects proposed in the LRWWMP may also result in energy conservation features such as improvements to lift stations and strategies to increase system efficiency. Best management practices will be used in the design, construction and operations of the infrastructure proposed by the Plan, in accordance with local, state, and federal laws, during the planning and construction of any applicable projects. Proposed projects will be reviewed and addressed on an individual basis for energy and natural resources impacts by appropriate agencies prior to implementation.

4. How would the proposal be likely to use or affect environmentally sensitive areas or areas designated (or eligible or under study) for governmental protection; such as parks, wilderness, wild and scenic rivers, threatened or endangered species habitat, historic or cultural sites, wetlands, floodplains, or prime farmlands?

Adoption of the LRWWMP will not itself result in direct effects to environmentally sensitive areas or areas designated for governmental protection, however, there is potential for the Plan's programs and projects to occur in the immediate vicinity of sensitive areas. The potential impacts from these actions are currently unknown. Specific projects that are subject to environmental review will be evaluated for potential impacts and corresponding mitigation measures prior to implementation.

Proposed measures to protect such resources or to avoid or reduce impacts are:

Specific projects that are subject to environmental review will be evaluated by the appropriate agencies for their potential impact and corresponding mitigation measures prior to implementation. All such projects will be required to comply with applicable local, state, and federal guidelines and regulations regarding environmental protection.

5. How would the proposal be likely to affect land and shoreline use, including whether it would allow or encourage land or shoreline uses incompatible with existing plans?

Adoption of the LRWWMP will not itself result in direct effects to land and shoreline use and will not allow or encourage land or shoreline uses incompatible with existing plans. Specific projects that are subject to environmental review will be evaluated for land and shoreline use prior to implementation.

Proposed measures to avoid or reduce shoreline and land use impacts are:

The LRWWMP is designed to support City land use plans, including adhering to the guidelines set by the state Growth Management Act. All such projects will be required to comply with applicable local, state, and federal guidelines and regulations regarding shoreline and land use. Proposed projects will be reviewed and addressed on an individual basis by appropriate agencies prior to implementation.

6. How would the proposal be likely to increase demands on transportation or public services and utilities?

Adoption of the LRWWMP will not increase the demand for transportation, public services, or utilities. The Plan itself is partly in response to population growth and increased demands on the sewer utility. Sewer demand projections are included in Chapter 4 of the 2021 City of Renton Long Range Wastewater Management Plan.

Proposed measures to reduce or respond to such demand(s) are:

The proposed LRWWMP was developed, in part, as a response to increased demands on the City's sewer utility system.

7. Identify, if possible, whether the proposal may conflict with local, state, or federal laws or requirements for the protection of the environment.

The 2021 City of Renton Long Range Wastewater Management Plan does not conflict with any known local, state, or federal environmental laws or requirements. Specific projects that are subject to environmental review will be evaluated for adherence to environmental laws or requirements prior to implementation.

DEPARTMENT OF COMMUNITY & ECONOMIC DEVELOPMENT

Planning Division

1055 South Grady Way, 6th Floor | Renton, WA 98057 | 425-430-7200, ext. 2

www.rentonwa.gov



NOTICE OF ENVIRONMENTAL DETERMINATION

ISSUANCE OF A DETERMINATION OF NON-SIGNIFICANCE (DNS) POSTED TO NOTIFY INTERESTED PERSONS OF AN ENVIRONMENTAL ACTION

DNS: THE CITY OF RENTON ENVIRONMENTAL REVIEW COMMITTEE (ERC) HAS DETERMINED THAT THE PROPOSED ACTION DOES NOT HAVE A SIGNIFICANT ADVERSE IMPACT ON THE ENVIRONMENT.

DATE OF NOTICE OF ENVIRONMENTAL DETERMINATION: June 17, 2021

PROJECT NAME/NUMBER: PR21-000001 Long Range Wastewater Management Plan Environmental Review / LUA21-000116, ECF

PROJECT LOCATION: Citywide

APPLICANT/PROJECT CONTACT PERSON: Ann Fowler, City of Renton / 1055 S Grady Way, Renton, WA 98057 / afowler@rentonwa.gov

LOCATION WHERE APPLICATION MAY BE REVIEWED: Applicant documents are available online through the City of Renton Document Center website. See also <https://cutt.ly/knhndiq>

PROJECT DESCRIPTION: The applicant, the City of Renton Public Works Department, is requesting SEPA Environmental Review for the City of Renton 2021 Long Range Wastewater Management Plan. The subject plan will be reviewed as a non-project action, as defined by Section 197-11-774 in the Washington Administrative Code. The plan primarily serves as an update to the City of Renton's 2010 Long Range Wastewater Management Plan and was developed collaboratively by City staff and Carollo Engineers, Inc. (Carollo), including ADS Environmental Services LLC as part of the Carollo team. The plan addresses policies, criteria, assumptions, and recommendations regarding the Wastewater Management of the City's planning area with consideration to population growth and increased demands on the sewer utility. The plan will be used as a guide in maintaining and improving the water system in the short-term over the next 10 years. It also provides a planning framework for the 20-year, long-term planning horizon.

The primary purpose of this plan is to identify capacity deficiencies in the wastewater collection system, develop feasible alternatives to correct these deficiencies, and plan the infrastructure that will serve future development by addressing facility reliability, public health, groundwater and environmental protection, operation and maintenance, and financing issues. Maintaining a current Plan is required to meet the regulations of the Washington State Department of Health (DOH) and the requirements of the Washington State Growth Management Act. The plan also contains estimated timeframes, which are the intended framework for future funding decisions. The applicant submitted an Environmental (SEPA) Checklist with the application.

Per WAC197-11-340(2)(c) any person, affected tribe, or agency may submit comments to the City within fourteen days of the date of issuance of the DNS.

Appeals of the environmental determination must be filed in writing on or before 5:00 p.m. on July 1, 2021. Appeals to the Examiner are governed by RMC 4-8-110 and more information regarding the appeal process may be obtained from the Renton City Clerk's Office, (425) 430-6510. Due to Governor Jay Inslee's Proclamation 20-25 ("Stay Home, Stay Healthy"), the City Clerk's Office is working remotely. For that reason, appeals must be submitted electronically to the City Clerk at cityclerk@rentonwa.gov. The appeal fee, normally due at the time an appeal is submitted, will be collected at a future date. Appeals to the Hearing Examiner are governed by RMC 4-8-110 and additional information regarding the appeal process may be obtained from the City Clerk's Office, cityclerk@rentonwa.gov. If the situation changes such that the City Clerk's Office is open when you file your appeal, you have the option of filing the appeal in person.

CONTACT PERSON: Brittany Gillia, Assistant Planner; Tel: (425) 430-7246; Email: bgillia@rentonwa.gov





**DEPARTMENT OF COMMUNITY
AND ECONOMIC DEVELOPMENT**

**ENVIRONMENTAL (SEPA) DETERMINATION OF
NON-SIGNIFICANCE (DNS)**

PROJECT NUMBER: PR21-000001/LUA21-000116, ECF
 APPLICANT: Ann Fowler, City of Renton / 1055 S Grady Way, Renton, WA 98057 /
 afowler@rentonwa.gov
 PROJECT NAME: Long Range Wastewater Management Plan Environmental Review

PROJECT DESCRIPTION: The applicant, the City of Renton Public Works Department, is requesting SEPA Environmental Review for the City of Renton 2021 Long Range Wastewater Management Plan. The subject plan will reviewed as a non-project action, as defined by Section 197-11-774 in the Washington Administrative Code. The plan primarily serves as an update to the City of Renton's 2010 Long Range Wastewater Management Plan and was developed collaboratively by City staff and Carollo Engineers, Inc. (Carollo), including ADS Environmental Services LLC as part of the Carollo team. The plan addresses policies, criteria, assumptions, and recommendations regarding the Wastewater Management of the City's planning area with consideration to population growth and increased demands on the sewer utility. The plan will be used as a guide in maintaining and improving the water system in the short-term over the next 10 years. It also provides a planning framework for the 20-year, long-term planning horizon.

The primary purpose of this plan is to identify capacity deficiencies in the wastewater collection system, develop feasible alternatives to correct these deficiencies, and plan the infrastructure that will serve future development by addressing facility reliability, public health, groundwater and environmental protection, operation and maintenance, and financing issues. Maintaining a current Plan is required to meet the regulations of the Washington State Department of Health (DOH) and the requirements of the Washington State Growth Management Act. The plan also contains estimated timeframes, which are the intended framework for future funding decisions. The applicant submitted an Environmental (SEPA) Checklist with the application.

PROJECT LOCATION: Citywide
 LEAD AGENCY: City of Renton
 Environmental Review Committee
 Department of Community & Economic Development

The City of Renton Environmental Review Committee has determined that it does not have a probable significant adverse impact on the environment. An Environmental Impact Statement (EIS) is not required under RCW 43.21C.030(2)(c). This Determination of Non-Significance is issued under WAC 197-11-340. Because other agencies of jurisdiction may be involved, the lead agency will not act on this proposal for fourteen (14) days.

Appeals of the environmental determination must be filed in writing on or before 5:00 p.m. on July 1, 2021. Due to Governor Jay Inslee's Proclamation 20-25 ("Stay Home, Stay Healthy"), the City Clerk's Office is working remotely. For that reason, appeals must be submitted electronically to the City Clerk at cityclerk@rentonwa.gov. The appeal fee, normally due at the time an appeal is submitted, will be collected at a future date. Appeals to the Hearing Examiner are governed by RMC 4-8-110 and additional information regarding the appeal process may be obtained from the City Clerk's

SIGNATURES:

 Martin Pastucha, Administrator
 Public Works, Chair
 Date

 Kelly Beymer
 66EC1E23C7044F7...
 Kelly Beymer, Administrator
 Community Services Department
 Date

 Kelly Beymer
 6/17/2021 | 10:45 AM PDT

DocuSigned by:
Anjela Barton 6/17/2021 | 2:16 PM PDT
 C4D0D9BD92A54A0...

 Anjela Barton, Fire Marshal
 Renton Regional Fire Authority
 Date

 Chip Vincent
 49DB377706A9477
 Chip Vincent, Administrator
 Community and Economic Development
 Date

 Chip Vincent
 6/17/2021 | 10:54 AM PDT



**DEPARTMENT OF COMMUNITY
AND ECONOMIC DEVELOPMENT**

Office, cityclerk@rentonwa.gov. If the situation changes such that the City Clerk's Office is open when you file your appeal, you have the option of filing the appeal in person.

DATE OF DECISION: June 17, 2021

Appendix B

AGENCY COMMENT LETTERS AND RESPONSES



Chapter 3 - Operational Policies and Criteria

Project Name: Long Range Wastewater Management Plan

Client: City of Renton

Date Last Updated: 2/28/2022

Comment No.	Section/Page	Comment By	Comment	Response	Change to Plan	Reference Docs	Person Responsible	Status of Change
1	3.3.2 / Page 3-2	Ecology	The third bullet in this section references "private sewerage disposal systems". Please add clarity about the types of facilities the city considers "private sewerage disposal systems". How does the city's definition and allowance for private sewers align with the requirement of public ownership of domestic sewage facilities in WAC 173-240-104?	The definition of a private sewerage disposal system is the side sewer from building to main.	No change to Plan.			Complete
2	3.7.2 / Page 3-9	Ecology	Related to comment above, the third to last bullet on page 3-9 talks about "private multi family and single family pump stations" and references city standards/code. While the city code (RMC 4-6-040.F.6) talks about private lift stations for commercial and multi-family buildings, it does not provide much clarity beyond requiring "alarm and standby emergency operation systems, and meet or exceed Department of Ecology specifications as detailed in "Criteria for Sewage Works Design"". In addition, although the code (RMC 4-6-040.G.5) states that sewage from building drains "shall be lifted by approved artificial means and discharged to the building sewer" when gravity discharge is not possible, the code contains no standards for this type of connection. Please verify whether the city has specific design standard for these lift stations. Also, as discussed above, clarify how the city's code ensures compliance with the public ownership requirement in WAC 173-240-104.	The City provides development guidelines for the pump stations and review during building permit approval. The City is working to develop design standards.	Development handout referenced in Section 3.7.2 and included in the appendix.			Complete



Chapter 3 - Operational Policies and Criteria

Project Name: Long Range Wastewater Management Plan

Client: City of Renton

Date Last Updated: 2/28/2022

Comment No.	Section/Page	Comment By	Comment	Response	Change to Plan	Reference Docs	Person Responsible	Status of Change
3	3.5 and 3.5.2	UTRC	<p>Section 3.5 (Service Area and Extension Objectives) states: Ensure the availability of an adequate level of sanitary sewer service to areas annexing to the City or areas within the City's Potential Annexation Area (PAA). But then immediately thereafter in 3.5.2 (Implementation) states: Sanitary sewer service to properties outside the City's corporate limits will not be permitted except under the following conditions:</p> <p>One of the conditions of 3.5.2 should be that the subject area is a PAA within the UGA. To add confusion, UTRC staff recently received a Certificate of Sewer Availability for a proposed subdivision at 14310 SE 140th St, in the PAA. The certificate states that "The City has no plans to extend sanitary sewer within this portion of our sewer service are[a] within the next 20 years." In fact, the plan doesn't show appear to show any extension of service into the PAAs, despite Policy 3.5 above. Please clarify.</p>	<p>The City intends to serve all areas in the City Limits and Potential Annexation Areas. The extension of the City's system may be required by the developer. The City Code is being reviewed to align with this intention.</p>	No change to Plan.			Complete
4	Page 3-6	UTRC	<p><i>In the UGA all new development shall be served by public sewers, unless application of this policy to a proposal for a single-family residence on an individual lot would deny all reasonable use of the property; or sewer service is not available for a proposed short subdivision of urban property in a timely or reasonable manner as determined by the Utility Technical Review Committee. These onsite system shall be managed by one of the following entities, in order or preference, the sewer utility whose service area encompasses the proposed short subdivision, the provider most likely to serve the area, or an Onsite Sewage System Maintainer certified by the Public Health – Seattle & KC (2018 King County Comprehensive Plan, Policy F-255)</i></p> <p>"These onsite system..." should read "These onsite systems..."</p> <p>"Utility Technical Review Committee" should read "King County Utility Technical Review Committee" Does the City manage on-site systems? KC Permitting has an application in for a short plat right now that may need on-site instead of sewer.</p>	<p>Text edits will be incorporated, as follows: In the UGA all new development shall be served by public sewers, unless application of this policy to a proposal for a single-family residence on an individual lot would deny all reasonable use of the property; or sewer service is not available for a proposed short subdivision of urban property in a timely or reasonable manner as determined by the King County Utility Technical Review Committee. These onsite systems shall be managed by the property owner that can consider an Onsite Sewage System Maintainer certified by the Public Health – Seattle & KC.</p>	Text updated on page 3-6.			Complete



Chapter 4 - Planning Considerations

Project Name: Long Range Wastewater Management Plan

Client: City of Renton

Date Last Updated: 7/7/2022

Comment No.	Section/Page	Comment By	Comment	Response	Change to Plan	Reference Docs	Person Responsible	Status of Change
1	4.4.5 / Page 4-16	Ecology	The final sentence in this section states that the city has seven adjoining sewer utilities, but the subsections that follow (as well as Figure 4.2) list only six. While the section discusses KC regional wastewater, Ecology does not view the county as an "adjoining sewer utility" since it is a wholesale sewer service provider that receives wastewater from the city's planning area.	Text in Section 4.4.5 updated.	Text in Section 4.4.5 updated to change "adjoining" to "neighboring utilities"			Complete
2	4.4.5.9 / Page 4-18	Ecology	RCW 90.48.112 requires general sewer plans to "include consideration of opportunities for the use of reclaimed water". The Reclaimed Water Use Law (RCW 90.46) also requires coordination between wastewater system and water system plans in the evaluation of opportunities to use reclaimed water. While this general sewer plan discusses the city's work with King County and other stakeholders in reclaimed water comprehensive planning, it does not provide much detail on the status of these efforts. It also does not discuss steps the city has taken to ensure coordination between this general sewer plan and its water system plan on the topic of reclaimed water use. Please expand the discussion to address these topics.	Reclaimed Water Opportunities will be consistent with City's Water System Plan. Text will be updated.	Text updated consistent with City's Water System Plan.			Complete



Chapter 4 - Planning Considerations

Project Name: Long Range Wastewater Management Plan

Client: City of Renton

Date Last Updated: 7/7/2022

Comment No.	Section/Page	Comment By	Comment	Response	Change to Plan	Reference Docs	Person Responsible	Status of Change
3	Figure 4.2	Soos Creek	<p>It appears there may be a discrepancy in the service area between the City and District. See attached markup of Figure 7-2 from the District Sewer Comprehensive Plan. This area, while outside the District's Sewer Corporate Boundary, it is within the District's Sewer Planning Boundary and is currently served by the District.</p> <p>Additionally, in order to confirm that both the City and District's sewer service areas align, we request the City share its GIS sharefile so it can be overlaid with the District's boundary to avoid any future conflict.</p>	Boundary investigated and is correct in the Plan. Information has been sent to Soos Creek for review.	No change to Plan.			Complete
4	4.4.5 / Page 4-16	Soos Creek	<p>It appears there is an agreement missing from the list, CAG-91-083, Arden #2-08, that amended the 1991 Agreement. Please see attached copy that was executed in 2008. Additionally, the transfer of service boundaries needs to be reviewed and revised as necessary per the Exhibits A and B of the attached Agreement.</p>	Agreement to be added to Appendix and update text.	Agreement to be added to Appendix and update text.			Complete
5	Figure 4.1	UTRC	<p>That which is called the urban growth boundary is incorrect. The growth boundary is a much larger area surrounding the developed areas of King County. You're showing Renton Corporate Limits plus the Potential Annexation Areas, which is not the same this as the King County designated UGA. In the figure below, the red line represents the extent of the Urban Growth Area, and the shaded green areas are Potential Annexation Areas in unincorporated King County adjacent to Renton. Section 4.3.2 explains this correctly.</p>	Thank you for the comment. Figure updated.	UGA has been changed to PAA in Figure 4.1 and text updated.			Complete
6	Figure 4-3	UTRC	<p>Figure 4-3 Wastewater Service Boundary line typology is very hard to see in certain areas. Recommend smaller dash size and different color.</p>	Thanks for the comment.	Figure has been updated.			Complete



Chapter 4 - Planning Considerations

Project Name: Long Range Wastewater Management Plan

Client: City of Renton

Date Last Updated: 7/7/2022

Comment No.	Section/Page	Comment By	Comment	Response	Change to Plan	Reference Docs	Person Responsible	Status of Change
7	4.4.4.1	UTRC	All of the service area in unincorporated KC is designated "urban", with the exception of the service to Apollo Elementary School just east of the urban growth areas (UGAs). UGAs are intended to develop at urban densities and with urban service levels. This should read:just east of the Urban Growth Area (UGA). Land within the UGA is intended to develop at urban densities and with urban service levels.	Section 4.4.4.1 updated.	Section 4.4.4.1 updated.			Complete
8	4.4.4.1	UTRC	Immediately below, this plan makes reference to community plans which are out of date and no longer active: Unincorporated areas of KC are divided into community planning areas, each with a community plan. For the purposes of the LRWWMP, community plans were based on those adopted as part of the 2012 King County Comprehensive Plan. Where conflicts or inconsistencies between the policies of the community plans and KC's Comprehensive Plan occur, the Comprehensive Plan takes precedence. Three community plans, Soos Creek, West Hill, and Newcastle, cover most of the unincorporated areas within the study area of this LRWWMP.	Section 4.4.4.1 updated.	Section 4.4.4.1 updated.			Complete



King County

Utilities Technical Review Committee

Department of Local Services

35030 SE Douglas St #210

Snoqualmie, WA 98065

www.kingcounty.gov

City of Renton Draft Long-Range Wastewater Management Plan – Initial Review

The City of Renton submitted their draft Long Range Wastewater Management Plan for review by the King County Utilities Technical Review Committee (UTRC). On August 25, 2021, the UTRC held an open public meeting and deliberated the plan content, then directed Staff to issue this comment letter. The UTRC would like to see the following clarifications and revisions as detailed below.

General Notes:

With such a large document, it would be helpful to have the table of contents be live linked, or for there to be navigation options in the PDF.

Many of the boundaries are identified using dashed lines with large gaps, making it very hard to see outlines in areas of complex topology. Recommend using solid lines or smaller dashes to demarcate boundaries.

Breakout maps or inset maps may be helpful in areas of dense feature/data concentration.

Section 3.5 (Service Area and Extension Objectives) states:

Ensure the availability of an adequate level of sanitary sewer service to areas annexing to the City or areas within the City's Potential Annexation Area (PAA).

But then immediately thereafter in 3.5.2 (Implementation) states:

Sanitary sewer service to properties outside the City's corporate limits will not be permitted except under the following conditions:

One of the conditions of 3.5.2 should be that the subject area is a PAA within the UGA.

To add confusion, UTRC staff recently received a Certificate of Sewer Availability for a proposed subdivision at 14310 SE 140th St, in the PAA. The certificate states that "The City has no plans to extend sanitary sewer within this portion of our sewer service area[a] within the next 20 years."

In fact, the plan doesn't show appear to show any extension of service into the PAAs, despite Policy 3.5 above. Please clarify.

Figure 4-1. That which is called the urban growth boundary is incorrect. The growth boundary is a much larger area surrounding the developed areas of King County. You're showing Renton Corporate Limits

plus the Potential Annexation Areas, which is not the same this as the King County designated UGA. In the figure below, the red line represents the extent of the Urban Growth Area, and the shaded green areas are Potential Annexation Areas in unincorporated King County adjacent to Renton. Section 4.3.2 explains this correctly.

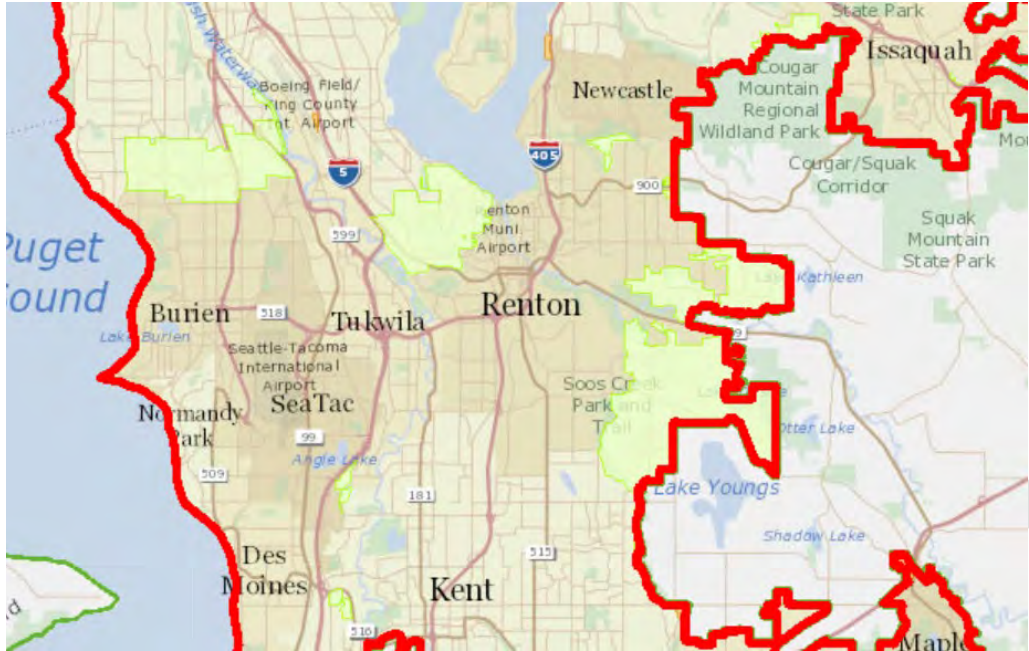

Figure 4-3 Wastewater Service Boundary line typology is very hard to see in certain areas. Recommend smaller dash size and different color.

In Section 4.4.4.1 King County Land Use:

All of the service area in unincorporated KC is designated “urban”, with the exception of the service to Apollo Elementary School just east of the urban growth areas (UGAs). UGAs are intended to develop at urban densities and with urban service levels.

This should read:

...just east of the Urban Growth Area (UGA). Land within the UGA is intended to develop at urban densities and with urban service levels.

Immediately below, this plan makes reference to community plans which are out of date and no longer active:

Unincorporated areas of KC are divided into community planning areas, each with a community plan. For the purposes of the LRWWMP, community plans were based on those adopted as part of the 2012 King County Comprehensive Plan. Where conflicts or inconsistencies between the

policies of the community plans and KC's Comprehensive Plan occur, the Comprehensive Plan takes precedence. Three community plans, Soos Creek, West Hill, and Newcastle, cover most of the unincorporated areas within the study area of this LRWWMP.

[King County Comprehensive Plan: Subarea plans - King County](#)

Current Community Service Area	Former Community Planning Areas
Bear Creek / Sammamish	Bear Creek, Northshore, East Sammamish
Four Creeks / Tiger Mountain	Tahoma Raven Heights, Snoqualmie
Greater Maple Valley / Cedar River	Tahoma Raven Heights, Soos Creek, East King County, Snoqualmie
SE King County	Enumclaw, Tahoma Raven Heights, East King County, Soos Creek
Snoqualmie Valley / NE King County	Snoqualmie, East King County, East Sammamish
Vashon / Maury Island	Vashon
West King County (unincorporated)	Portions of 10 different Community Planning Areas

King County Franchise No. 14056, 2001 - Grants the City the right to construct sewer lines along KC roads. Just as a reminder, expires in 4.5 years.

Page 3-6

In the UGA all new development shall be served by public sewers, unless application of this policy to a proposal for a single-family residence on an individual lot would deny all reasonable use of the property; or sewer service is not available for a proposed short subdivision of urban property in a timely or reasonable manner as determined by the Utility Technical Review Committee. These onsite system shall be managed by one of the following entities, in order or preference, the sewer utility whose service area encompasses the proposed short subdivision, the provider most likely to serve the area, or an Onsite Sewage System Maintainer certified by the Public Health – Seattle & KC (2018 King County Comprehensive Plan, Policy F-255)

“These onsite system...” should read “These onsite systems...”

“Utility Technical Review Committee” should read “King County Utility Technical Review Committee”

Does the City manage on-site systems? KC Permitting has an application in for a short plat right now that may need on-site instead of sewer.

On Page 9-1, the text states that “The SDC allocation based on meter size is shown in Table 9.3.” We assume that you’re basing charges on the property’s associated water meter size, and not installing sewer meters, but please clarify.

In Table 9.8 and the preceding text, it sounds as if this LRWWMP CIP would be underfunded by nearly \$1.76 million over the next six years compared to the WRRM revenue-based model. We're interested in knowing more about the relationship of these two documents and the likelihood of the City being able to financially complete the CIP.

DRAFT

City of Renton General Sewer Plan - Review Comment/Response Form

Review Phase: Draft
 Contact: Ann Fowler, City of Renton

Reviewed By: Shawn McKone, PE
 Comment Date: 9/1/2021

No.	Dwg. Sheet No.	Sector	Comment	Reviewer last name	Response	Responder	Reviewer Check Off	Implementation	
	Spec. & Page No.	Paragraph No.						Date	Initials
1	Pages 1-2 and 1-5	Sec. 1.4	The regulatory requirements listed under Ecology's authority in this section are incomplete. The following are missing: Consideration of Reclaimed Water (RCW 90.48.112) and consideration of water conservation measures (RCW 90.48.495). Both requirements generally relate to necessary coordination between the general sewer plan and the City's water system plan. In addition, RCW 90.46.120 requires Water System Planning under DOH's authority to evaluate opportunities for using reclaimed water in coordination with evaluations done in a general sewer plan submitted under RCW 90.48.110.	McKone					
2	Page 1-5	Table 1.1 (WAC Plan Requirements)	The table indicated that "discussion of the provision for treatment, discharge, and reuse" was "not included" because the service is performed by King County. This is not an appropriate claim. The general sewer plan must address the requirement of WAC 173-240-050(3)(h), which requires "A statement regarding provisions for treatment and discussion of the adequacy of the treatment." Although Ecology recognizes that the City does not own and operate a sewage treatment facility, it must still demonstrate in the general sewer plan the adequacy of treatment for all wastewater generated during the planning period. The plan must include sufficient discussion necessary to demonstrate that the City's agreements with King County will provide adequate treatment throughout the planning period. Please identify the capacity available to the city at the King County facilities for treatment and identify whether any agreements contain capacity constraints that may limit or otherwise constrain the City's ability to provide sewer service.	McKone					
3	Page 2-2	Figure 2.1/ES.1	The map of the existing system shows several (about 2 dozen) pump stations labeled as "King County." This is not consistent with information Ecology has about King County's wastewater infrastructure in the area, which identifies no wastewater pump stations owned or operated by King County Wastewater Treatment Division. Please clarify the ownership of these pump stations.	McKone					
4	Pages 2-13 through 2-17	Sec. 2.5 and Table 2.2	The text on these pages identify lift stations that appear to be equipped with overflows, but does not provide much detail about the overflows. Section 2.5.17 states that the Shy Creek lift station overflows to secondary wet well with third pump. In addition, sections on the Stonegate lift station (2.5.17) and Wedgewood lift station (2.5.19) also discuss overflow vaults. Finally, Table 2.2 shows a third "flow transfer" pump at the following pump stations, but there is no discussion in 2.5 about possible overflow vaults: Baxter, Cottonwood, East Valley. Please expand discussions in these sections to better describe the use of these "overflows", including the frequency of use and routing of flow to and from any storage related to these overflows. The text seems to suggest that these systems are designed to contain flow and not allow for overflows to the environment. However, further details are necessary to verify this assumption and to better understand how the city uses this strategy.	McKone					

No.	Dwg. Sheet No.	Sector	Comment	Reviewer last name	Response	Responder	Reviewer Check Off	Implementation	
	Spec. & Page No.	Paragraph No.						Date	Initials
5	Pages 2-19 through 2-21	Sec. 2.6 and Fig. 2.4	While the overall discussion of the water system is generally appropriate, the section should include additional information related to the following topics: discussion of water conservation measures and how they impact the city's sewer systems (see RCW 90.48.495) and coordination between water system planning and general sewer planning related to reclaimed water (see RCW 90.48.112 and RCW 90.46.120). Ecology also recommends including a map that shows the relationship between existing unsewered areas and wellhead protection areas.	McKone					
6	Page 3-2	Section 3.3.2	The third bullet in this section references "private sewerage disposal systems". Please add clarity about the types of facilities the city considers "private sewerage disposal systems". How does the city's definition and allowance for private sewers align with the requirement of public ownership of domestic sewage facilities in WAC 173-240-104?	McKone					
7	Page 3-9	Section 3.7.2	Related to comment 6 above, the third to last bullet on page 3-9 talks about "private multi family and single family pump stations" and references city standards/code. While the city code (RMC 4-6-040.F.6) talks about private lift stations for commercial and multi-family buildings, it does not provide much clarity beyond requiring "alarm and standby emergency operation systems, and meet or exceed Department of Ecology specifications as detailed in "Criteria for Sewage Works Design". In addition, although the code (RMC 4-6-040.G.5) states that sewage from building drains "shall be lifted by approved artificial means and discharged to the building sewer" when gravity discharge is not possible, the code contains no standards for this type of connection. Please verify whether the city has specific design standard for these lift stations. Also, as discussed above, clarify how the city's code ensures compliance with the public ownership requirement in WAC 173-240-104.	McKone					
8	Page 4-16	Sec. 4.4.5	The final sentence in this section states that the city has seven adjoining sewer utilities, but the subsections that follow (as well as Figure 4.2) list only six. While the section discusses KC regional wastewater, Ecology does not view the county as an "adjoining sewer utility" since it is a wholesale sewer service provider that receives wastewater from the City's planning area.	McKone					
9	Page 4-18	Sec. 4.4.5.9	RCW 90.48.112 requires general sewer plans to "include consideration of opportunities for the use of reclaimed water." The Reclaimed Water Use Law (RCW 90.46) also requires coordination between wastewater system and water system plans in the evaluation of opportunities to use reclaimed water. While this general sewer plan discusses the City's work with King County and other stakeholders in reclaimed water comprehensive planning, it does not provide much detail on the status of these efforts. It also does not discuss steps the City has taken to ensure coordination between this general sewer plan and its water system plan on the topic of reclaimed water use. Please expand the discussion to address these topics.	McKone					
10	Page 5-3	Sec. 5.2.5	The second paragraph of this section states that "several industries within the City have obtained [NPDES] permits." This statement is not accurate for the context of this section of the general sewer plan. The section appears to address the requirement of WAC 173-240-050(3)(i), which requires a "List of all establishments producing industrial wastewater, the quantity of wastewater and periods of production, and the character of the industrial wastewater insofar as it may affect the sewer system or treatment plant." While the facilities shown in Table 5.1 may have received coverage under a general NPDES permit for industrial stormwater, this permit is not administered by King County's Industrial Waste Program. Pretreatment permits issued by King County are State Waste Discharge permits issued under state authority (WAC 173-216). Although the permits are related to federal pretreatment standards, they are not NPDES permits. In addition, King County may issue "discharge authorizations" to industrial facilities that do not require a permit under the federal pretreatment program. These authorizations are generally based on county codes.	McKone					

No.	Dwg. Sheet No.	Sector	Comment	Reviewer last name	Response	Responder	Reviewer Check Off	Implementation	
	Spec. & Page No.	Paragraph No.						Date	Initials
11	Page 5-3	Sec. 5.2.5	Please expand this section to include more detail on policies and practices related to coordinating with King County's Industrial Waste Program to ensure industrial facilities receive appropriate pretreatment permitting.	McKone					
12	Page 5-3	Table 5.1	Related to comment 10 above, this table does not provide sufficient information to ensure consistency with WAC 173-240-050(3)(i). Please update the table to address the following: the quantity of wastewater and periods of production, and the character of the industrial wastewater insofar as it may affect the sewer system or treatment plant.	McKone					
13	Page 7-11	Sec. 7.9	Please expand the discussion of the city's Overflow Emergency Response Plan. Please include information on the history of SSOs experienced in the system along - particularly with respect to the frequency of SSOs, typical causes, and how the city has used information about SSOs to form its operations and emergency response plans. Please also include information related to procedures for notifying appropriate state and local agencies when SSOs occur. This discussion should include information on how the city responds to overflows that may impact any of the following: surface waters of the state, groundwater in wellhead protection areas, stormwater systems (either under the city's jurisdiction or another local jurisdiction), and areas accessible to the general public.	McKone					
14	Page 7-11	Sec. 7.10	Please expand the FOG Source Control section to add in a discussion of the city's policies related to enforcement of its FOG ordinance. In particular, clarify if there are any requirements for property owners to periodically inspect grease traps or other control devices and whether the city requires submission of these inspection reports.	McKone					
15	Page 7-15	Sec. 7.18.2	The final sentence of paragraph 2 under "Emergency operations" states that "The City follows all Ecology guidelines for emergency notification procedures". Please add details about how the city uses these guidelines, especially with respect to SSO notifications discussed in comment 13.	McKone					
16	Page 8-8	Sec. 8.4.6	The description of the Kenndale Lake Line Renewal project talks about the potential use of individual lift stations. Please provide more information on how the city envisions the use of individual lift stations in this project. In particular, please describe the design standards the city would use and clarify the ownership/O&M responsibilities for these systems.	McKone					
17	Page 9-1	Table 9.1	Please verify accuracy of the table. It is titled as "water utility monthly rates" rather than wastewater. In addition, the rates are not consistent with the city or county's published rates - both appear to be half of what they should be. Does the accuracy of this table impact any planning calculations presented in this chapter?	McKone					
18	Page 9-4	Sec. 9.3.1	Please verify the table references in this section. Should they cite Table 9.7 instead of 9.6?	McKone					
19		Appendix J - Standard Plans and Specifications	Although this appendix includes adequate detail for most collection system projects, it does not include specific details of standards for lift stations, including individual grinder pump facilities. According to WAC 173-240-030, Ecology may waive submission of engineering reports and design documents for sewer system projects when the general sewer plan includes standard design criteria. Based on the material presented in this appendix and throughout the general sewer plan, Ecology cannot provide this waiver for lift station projects.	McKone					

SOOS CREEK WATER & SEWER DISTRICT

14616 S.E. 192nd St. • Renton, WA 98058-9420 • Phone (253) 630-9900 • Fax (253) 630-5289

September 1, 2021

City of Renton
Attn: Ann Fowler, PE, Wastewater Utility CIP Project Manager
1055 S. Grady Way
Renton, WA 98075
VIA email: AFowler@Rentonwa.gov

Re: Long-Range Wastewater Management Plan – Agency Draft dated March 2021

Dear Ms. Fowler,

Thank you for the opportunity to review the City's Agency Draft of the Long-Range Wastewater Management Plan. We provide the following comments for your consideration:

Figure 4.2, Sewer Service Area and Adjacent Utility Systems

Appears there may be a discrepancy in the service area between the City and District. See the attached markup of Figure 7-2 from the District Sewer Comprehensive Plan. This area, while outside the District's Sewer Corporate Boundary, it is within the District's Sewer Planning Boundary and is currently served by the District.

Additionally, in order to confirm that both the City and District's sewer service areas align, we request the City share its GIS Shapefile so it can be overlaid with the District's boundary to avoid any future conflicts.

Chapter 4, Planning Considerations

Section 4.4.5 Adjacent Utility Systems/Joint Use, Service Agreements and Related Plans
Page 4-16, Soos Creek Water and Sewer District, formerly called Cascade Sewer District

It appears there is an agreement missing from the list, CAG-91-083, Adden #2-08, that amended the 1991 Agreement. Please see the attached copy that was executed in 2008. Additionally, the transfer of service boundaries needs to be reviewed and revised as necessary per the Exhibits A and B of the attached Agreement.

Thank you again for the opportunity to review the City's Agency Draft Long-Range Wastewater Management Plan. Should you have any questions, please feel free to contact me at 253.630.9900.

Sincerely,



Ron Speer, MPA
General Manager

cc: Pam Cobley, PACE Engineers
File

Attachments: SCWSD Figure 7-2 and 2008 Addendum Agreement

SOOS CREEK WATER & SEWER DISTRICT SEWER COMPREHENSIVE PLAN EXISTING AND PROPOSED SEWERAGE FACILITIES

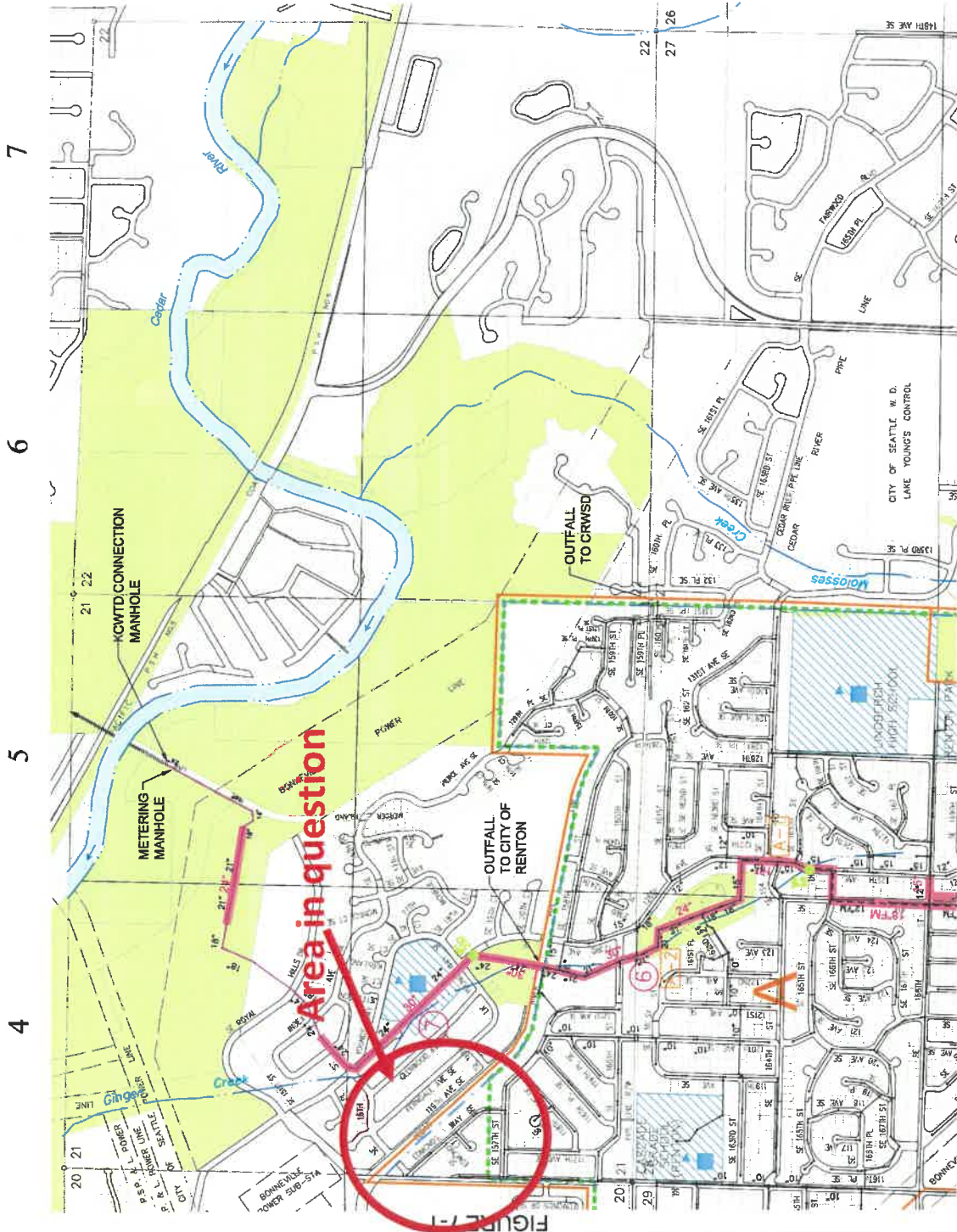

FIGURE 7-1

LEGEND

- SCWSD SEWER
- CORPORATE BOUNDARY
- SEWER PLANNING AREA (SERVICE AREA)
- DRAINAGE AREA BOUNDARY
- DRAINAGE AREA DESIGNATION
- B** --- URBAN GROWTH AREA BOUNDARY
- EXISTING GRAVITY FACILITIES
- EXISTING FORCE MAIN FACILITIES
- EXISTING LOW PRESSURE FACILITIES
- EXISTING SEWER BY ADJACENT PURVEYORS
- EXISTING SEWER BY METRO
- EXISTING LIFT STATION
- FUTURE LIFT STATION
- FUTURE GRAVITY FACILITIES
- FUTURE FORCE MAIN FACILITIES
- FUTURE LOW PRESSURE FACILITIES
- PIPE FACILITIES TO BE ADDED OR UPGRADED / NEW MAIN SIZE & REFERENCE NO.
- LIFT STATION FACILITIES TO BE ADDED, UPGRADED OR ABANDONED / REFERENCE NO.
- PROPOSED FLOW MONITOR LOCATION
- PROPOSED VISUAL MONITORING LOCATION
- WETLAND
- EXISTING SCHOOL SITE
- PARK
- GOLF COURSE

AA

A

B

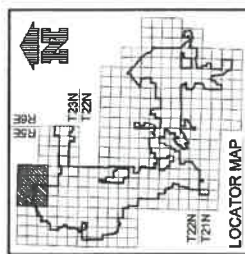

FIGURE 7-2
LOCATOR MAP

ROTHHILL
ROTH HILL LLC - Tel: 425.859.8048 www.rothhill.com
11130 NE 53rd Place, Suite 200 Bellevue, WA 98004

**2008 ADDENDUM TO
CITY OF RENTON & SOOS CREEK WATER AND SEWER DISTRICT
AGREEMENT FOR THE TRANSFER OF FACILITIES
AND FOR
THE ESTABLISHMENT OF SERVICE BOUNDARIES**

THIS ADDENDUM, made and entered into this 18th day of July, 2008, by and between the CITY OF RENTON, a Washington municipal corporation, hereinafter referred to as "the City", and SOOS CREEK WATER AND SEWER DISTRICT, a Washington municipal corporation, hereinafter referred to as "the District", both being duly organized and existing under and by virtue of the laws of the State of Washington,

WITNESSETH:

WHEREAS, with effective date of the 6th day of August, 1991, the City and the District entered into the following agreement:

CITY OF RENTON & SOOS CREEK WATER AND SEWER DISTRICT
AGREEMENT FOR THE TRANSFER OF FACILITIES
AND FOR
THE ESTABLISHMENT OF SERVICE BOUNDARIES

(1991 AGREEMENT); and

WHEREAS, by mutual agreement, the Agreement has been modified from time to time as to the boundaries of the City and District service areas to reflect service issues regarding the timing of various developments by the City and the District; and

WHEREAS, the parties now desire to again modify the AGREEMENT as to service area; and

WHEREAS, the 1991 AGREEMENT, as modified by this Addendum, will continue to provide for maximum efficient use of existing and future facilities, and the orderly and efficient water and sanitary sewer system planning.

NOW, THEREFORE:

IT IS HEREBY AGREED by and between the parties hereto as follows:

1. **Service Area Boundaries.** The parties have agreed that in consideration of the mutual agreements contained herein, the service area boundaries between the City and the District shall be modified as shown in Exhibit A hereto, which is incorporated herein by this reference.

2. **Amended Terms for Service by District.** The parties agree that the District may install a mainline sewer line in South 28th Street, which may serve into the City's sewer collection system.

3. **Amended Terms of Payment by District.** In consideration of the foregoing, the District will pay 50% of the collected General Facility Charges collected for the lots that connect to a mainline sewer line to be installed in South 28th Street to the City; such lots are identified in Exhibit B hereto, which is incorporated herein by this reference.

3. **Remaining Obligations Intact.** Nothing herein shall be construed to alter the rights, responsibilities, liabilities, or obligations of either the City or the District pursuant to either the 1991 AGREEMENT, or any amendments thereto, except as specifically set forth herein.

Approved by Resolution No. 3957 of the City Council of the CITY OF RENTON, Washington, at its regular meeting held on the 14th day of July, 2008.

CITY OF RENTON

By: _____

Denis Law

Title: _____

Denis Law, Mayor

Attest: _____

Bonnie I. Walton

City Clerk - Bonnie I. Walton

Approved by Motion of the Board of Commissioners of **SOOS CREEK WATER AND SEWER DISTRICT** of King County, Washington, at its regular meeting held on the 5 day of May, 2008.

SOOS CREEK WATER AND SEWER DISTRICT

By: 

Ron Speer, District Manager

EXHIBIT "A"

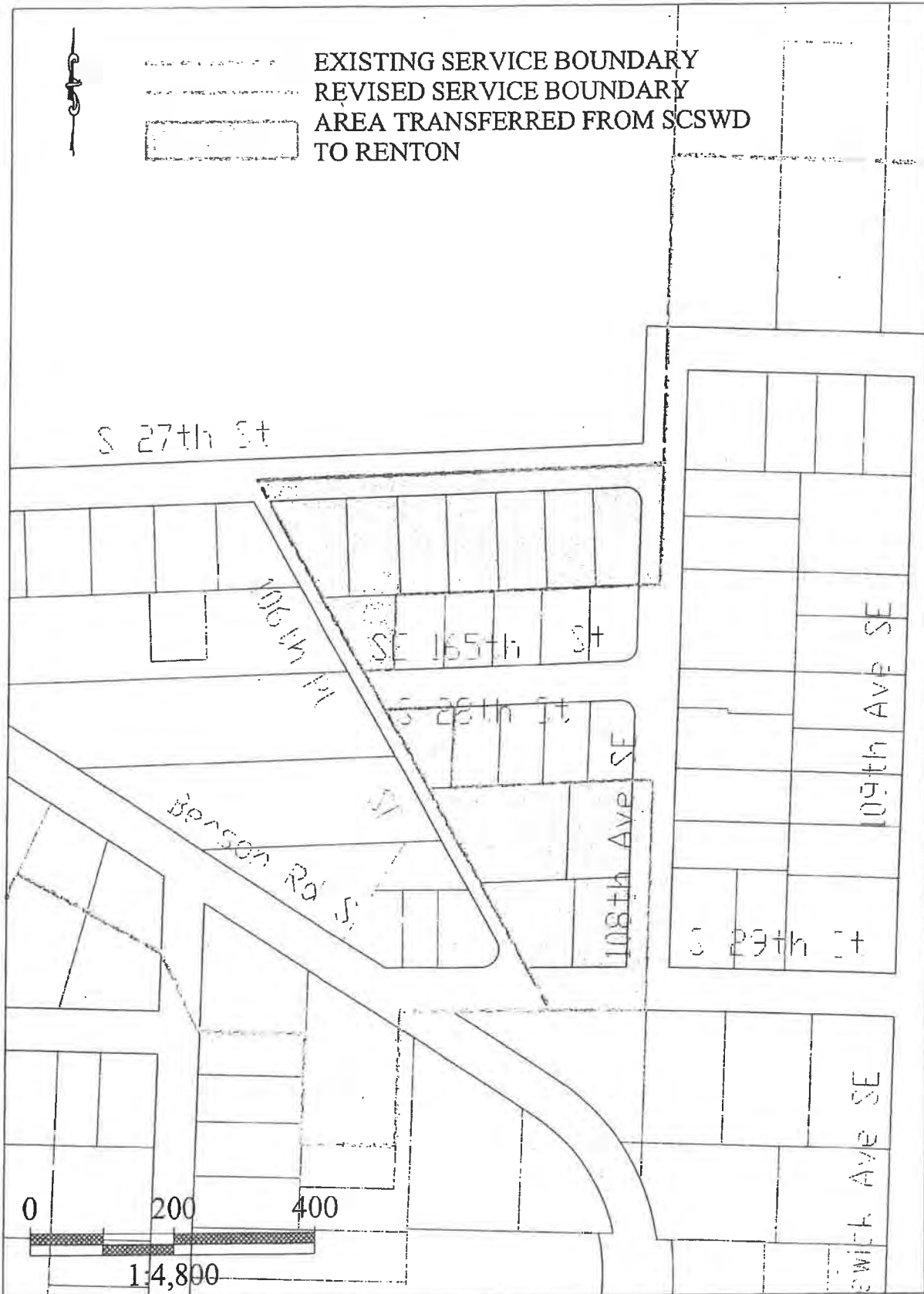
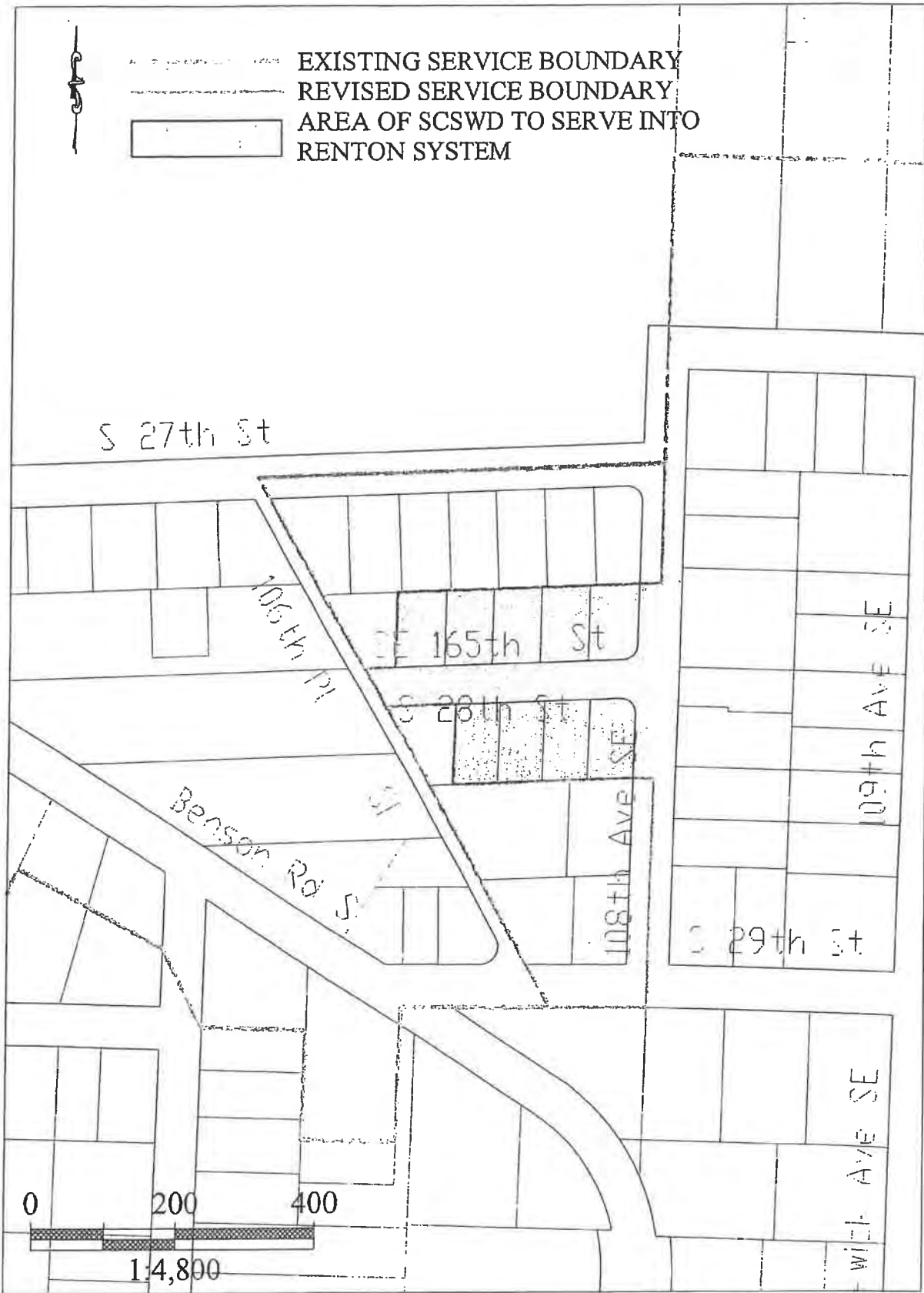

EXHIBIT "B"



Appendix C

APPROVALS

CITY OF RENTON, WASHINGTON

RESOLUTION NO. 4478

A RESOLUTION OF THE CITY OF RENTON, WASHINGTON, ADOPTING THE CITY OF RENTON LONG-RANGE WASTEWATER MANAGEMENT PLAN FINAL JULY 2022.

WHEREAS, the City of Renton Long Range Wastewater Management Plan Final July 2022 (“Plan”) documents the current status of the City’s wastewater system and evaluates future needs of the wastewater utility and will be used as a guide in maintaining and improving the wastewater system for the next 20 years, and

WHEREAS, the Plan was prepared in accordance with requirements of Washington Administrative Code (WAC) 173-240-050, which is administered by the Washington State Department of Ecology, and meets the requirements of the Growth Management Act; and

WHEREAS, the Plan was reviewed by the City of Renton Environmental Review Committee, which issued a Determination of Non-Significance on June 17, 2021; and

WHEREAS, a Notice of Environmental Determination was made public, and no comments or appeals were received during the public comment and appeal periods, which ended July 1, 2021; and

WHEREAS, the Plan was presented to the Renton City Council, discussed at a meeting of the Utilities Committee, and recommended for adoption by the full City Council; and

WHEREAS, the Plan is compatible with the intent of the City’s adopted Comprehensive Plan;

NOW, THEREFORE, THE CITY COUNCIL OF THE CITY OF RENTON, WASHINGTON, DO RESOLVE AS FOLLOWS:

RESOLUTION NO. 4478

SECTION I. The City Council hereby adopts the Plan, a copy of which is attached hereto as Exhibit "A" and incorporated by this reference.

PASSED BY THE CITY COUNCIL this 19th day of September, 2022.



Jason A. Seth, City Clerk

APPROVED BY THE MAYOR this 19th day of September, 2022.



Armondo Pavone, Mayor

Approved as to form:



Shane Moloney, City Attorney

RES 1918: 8/25/2022





STATE OF WASHINGTON
DEPARTMENT OF ECOLOGY

Northwest Region Office

PO Box 330316, Shoreline, WA 98133-9716 • 206-594-0000

November 17, 2022

Martin Pastucha
Public Works Administrator
City of Renton
1055 South Grady Way
Renton, WA 98057

RE: City of Renton Long Range Wastewater Management Plan – July 2022

Dear Martin Pastucha:

The Department of Ecology (Ecology) has reviewed the City of Renton's Long Range Wastewater Management Plan, dated July 2022. Pursuant to RCW 90.48.110 and WAC 173-240-030, Ecology hereby approves this document as a General Sewer Plan. A copy of the plan's cover page with Ecology's approval stamp is enclosed for your records.

Sewage facilities within the planning area boundary must be constructed according to the approved General Sewer Plan or amendments thereto. Engineering reports and plans and specifications for sewer lines extensions, including pump stations, need not be submitted for approval. In the following situations Ecology approval is necessary for sewer line extensions prior to construction:

- The proposed sewers or pump stations involve installation of overflows or bypasses.
- The proposed sewers or pump stations discharge to an overloaded treatment, collection, or disposal facility.

If you have any questions concerning this approval, please contact Shawn McKone at (206) 594-0158, or shawn.mckone@ecy.wa.gov.

Sincerely,

Rachel McCrea
Water Quality Section Manager
Northwest Region Office

Martin Pastucha
City of Renton Long Range Wastewater Management Plan
Page 2

ecc: Joseph Stowell, City of Renton
Lara Kammereck, Carollo Engineers
Jae Hill, King County Utility Technical Review Committee

Enclosure: Copy of Approved Cover

CITY OF RENTON

LONG-RANGE WASTEWATER MANAGEMENT PLAN

FINAL | July 2022

MAYOR

Armondo Pavone

CHIEF ADMINISTRATIVE OFFICER

Ed VanValey

PUBLIC WORKS DEPARTMENT ADMINISTRATOR

Martin Pastucha

UTILITY SYSTEMS DIRECTOR

Ron Straka

WASTEWATER UTILITY SYSTEMS DIVISION STAFF

Joseph Stowell

Michael Benoit

John Hobson

Don Ellis

Rick Moreno

MAINTENANCE SERVICES DIVISION STAFF

Nathan Nelson

Rocky Sittner



CITY COUNCIL

James Alberson, Jr.

Ryan McIrvin

Valerie O'Halloran

Ruth Pérez

Edward Prince

Carmen Rivera

Kim-Khánh Văn

PREPARED BY

City of Renton

with the assistance of
Carollo Engineers, Inc.





KING COUNTY

1200 King County Courthouse
516 Third Avenue
Seattle, WA 98104

Signature Report

Ordinance 19587

Proposed No. 2023-0086.1

Sponsors Upthegrove

1 AN ORDINANCE approving City of Renton Long-Range
2 Wastewater Management Plan dated July 2022.

3 STATEMENT OF FACTS:

4 1. King County has adopted K.C.C. chapter 13.24, which requires
5 approval of comprehensive plans for water and sewer utilities that provide
6 service in unincorporated King County as a prerequisite for operating in
7 unincorporated King County, receiving approval for annexation proposals,
8 being granted right of way franchises, and being given approval for right
9 of way construction permits. K.C.C. chapter 13.24 prescribes the
10 requirements for approval of such plans, including consistency with state
11 and local planning requirements.

12 2. The city of Renton’s last Long-Range Wastewater Management Plan
13 was prepared in 2010. King County regulations require wastewater
14 system plans to be updated every six years.

15 3. The city of Renton's wastewater system has a service area within King
16 County and has adopted a comprehensive wastewater plan ("the plan").

17 4. King County has adopted a Comprehensive Plan that includes policies
18 F-101 through F-264, the applicable portions of which address wastewater
19 policies for facilities and services; these wastewater policies call for

Ordinance 19587

20 consistency with other adopted plans, pursuit of reclaimed water, water
21 conservation and protection of water resources.

22 5. K.C.C. chapter 13.24 requires the Utilities Technical Review
23 Committee to review and make a recommendation to the King County
24 executive and council on the plan, the requirements under K.C.C. chapter
25 13.24 and consistency with the King County Comprehensive Plan. The
26 Utilities Technical Review Committee has reviewed the planning data and
27 system operations and has found:

28 a. The plan uses population and employment forecasts developed by the
29 Puget Sound Regional Council;

30 b. The system's service area is in unincorporated King County;

31 c. The capital facility plan is adequate to meet anticipated facility and
32 service needs;

33 d. The plan is consistent with applicable Washington state water quality
34 laws; and

35 e. The plan is consistent with other pertinent county adopted plans and
36 policies.

37 6. The Washington state Department of Ecology approved the plan on
38 November 17, 2022.

39 7. Under the State Environmental Policy Act, the city completed an
40 environmental checklist and issued a Determination of Nonsignificance
41 for the plan approval on June 17, 2021. There were no appeals.

Ordinance 19587

42 8. The system's operations and facilities meet multiple existing statutory,
43 administrative and planning standards. As the system's operations,
44 facilities and planning meet the requirements of the King County Code
45 and are consistent with the King County Comprehensive Plan, the Utilities
46 Technical Review Committee has recommended approval of the plan.

47 BE IT ORDAINED BY THE COUNCIL OF KING COUNTY:

48 SECTION 1. The City of Renton Long-Range Wastewater Management Plan

Ordinance 19587

49 dated July 2022, Attachment A to this ordinance, is hereby approved as a comprehensive
50 wastewater plan.

Ordinance 19587 was introduced on 2/28/2023 and passed by the Metropolitan King County Council on 4/4/2023, by the following vote:

Yes: 9 - Balducci, Dembowski, Dunn, Kohl-Welles, Perry, McDermott, Upthegrove, von Reichbauer and Zahilay

KING COUNTY COUNCIL
KING COUNTY, WASHINGTON

DocuSigned by:

E76CE01F07B14EF...
Dave Upthegrove, Chair

ATTEST:

DocuSigned by:

C267B914088E4A0...
Melani Pedroza, Clerk of the Council

APPROVED this ____ day of 4/12/2023, _____.

DocuSigned by:

4FBCAB8196AE4C6...
Dow Constantine, County Executive

Attachments: A. City of Renton Long-Range Wastewater Management Plan July 2022

Appendix D



HYDRAULIC MODEL AND DEFICIENCY RESULTS

Appendix D

HYDRAULIC MODEL AND DEFICIENCY RESULTS

This Appendix goes through all the deficiencies presented in chapter 5 and shows the location and the hydraulic profile where the surcharging and flooding occurs. The hydraulic grade line profiles can be used to identify the cause of the deficiency. Physical flow constraints are primarily identified as negative sloped pipes, undersized pipes, and downstream backwater conditions. Current and buildout system results are shown for the February 96 storm event. For deficiencies that emerged only for buildout scenarios just the buildout system HGL is shown.

A legend for all the HGL profiles is shown below:

	Feb 96 design storm – buildout system
	Feb 96 design storm - current system
	Ground Level

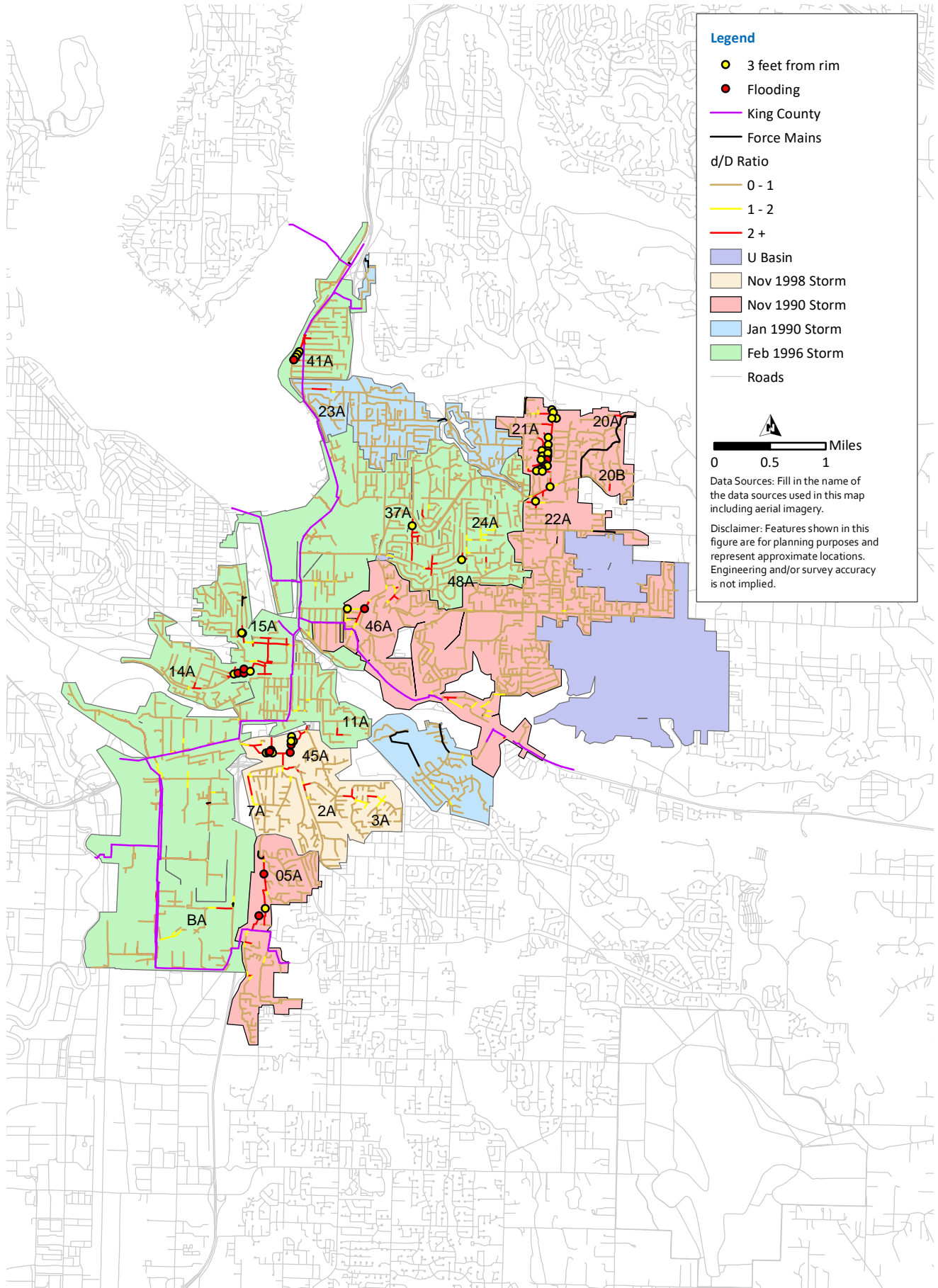

Deficiency 05A:

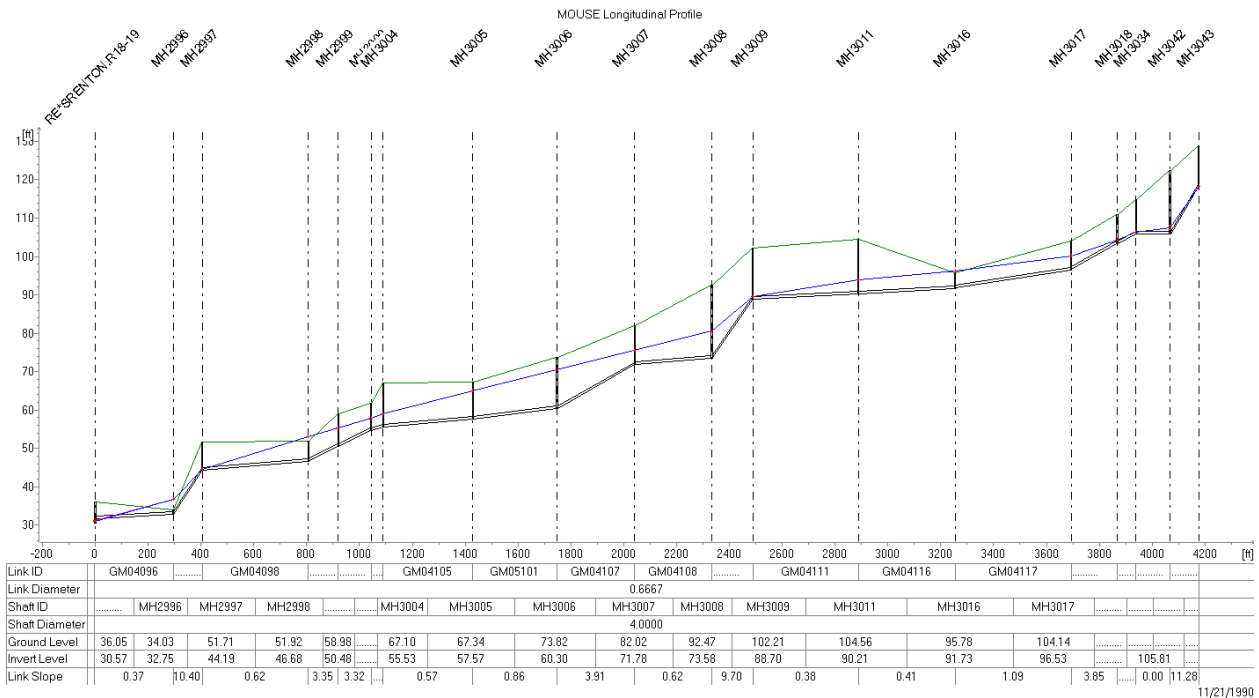
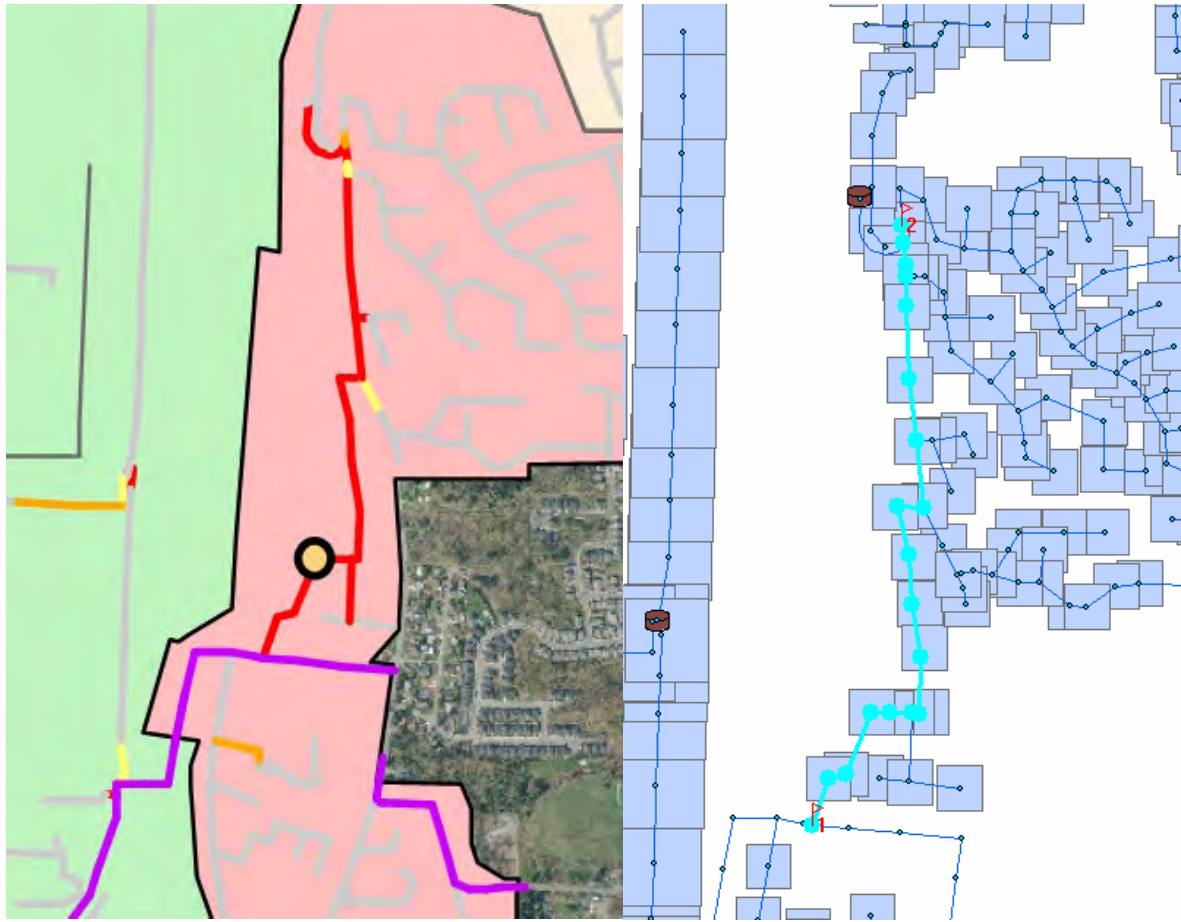

Deficiency 45A:

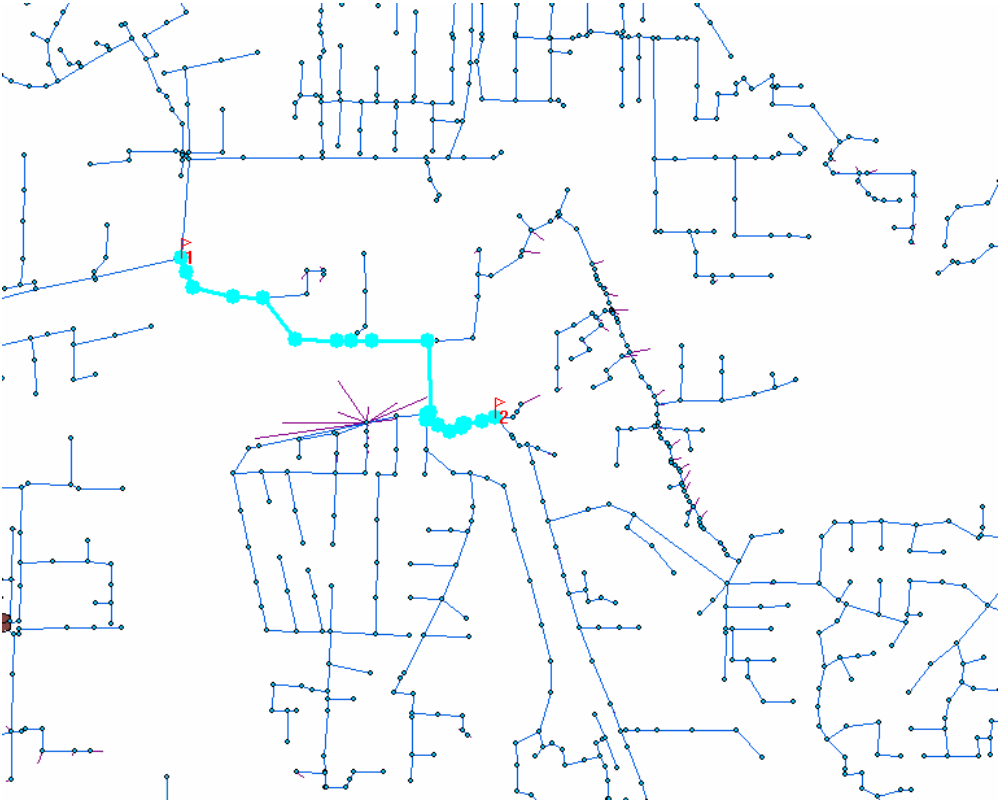
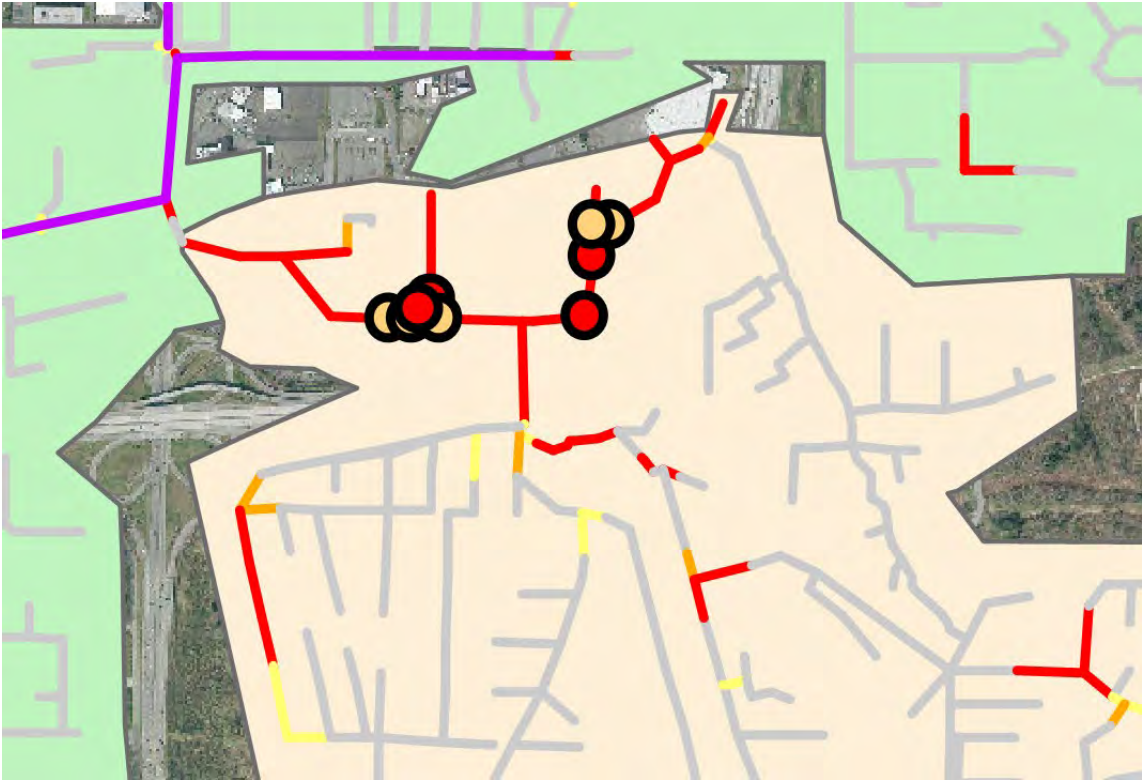

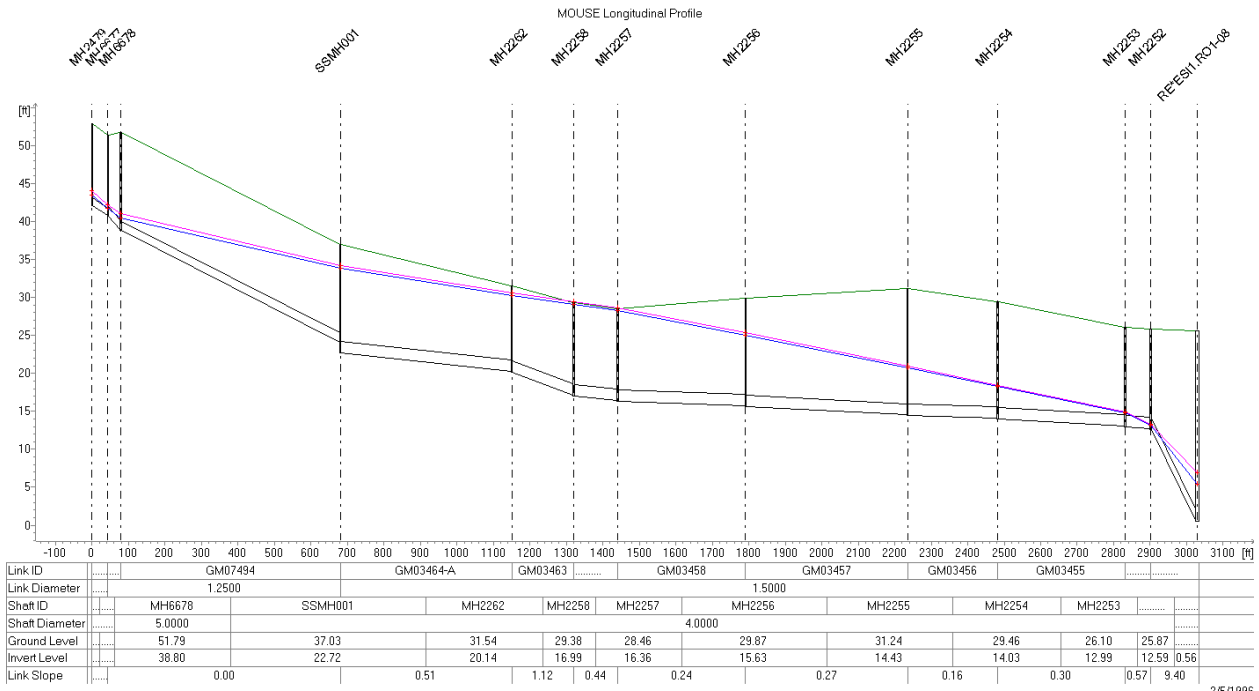

Deficiency 7A, 2A, and 3A are upstream of this.

Deficiency 46A:

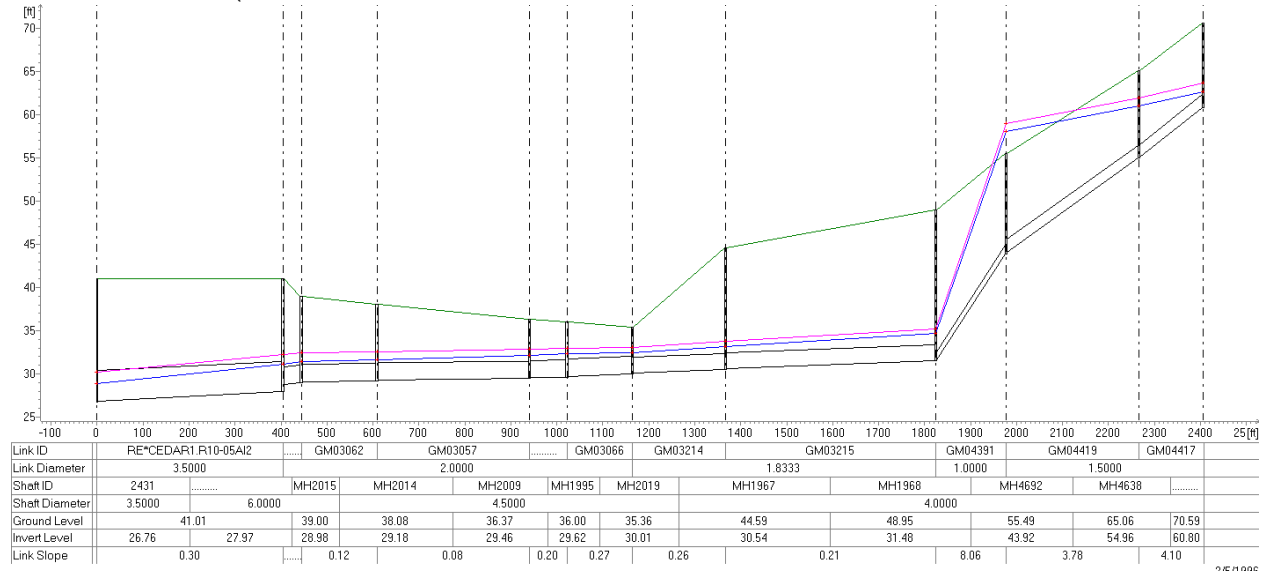
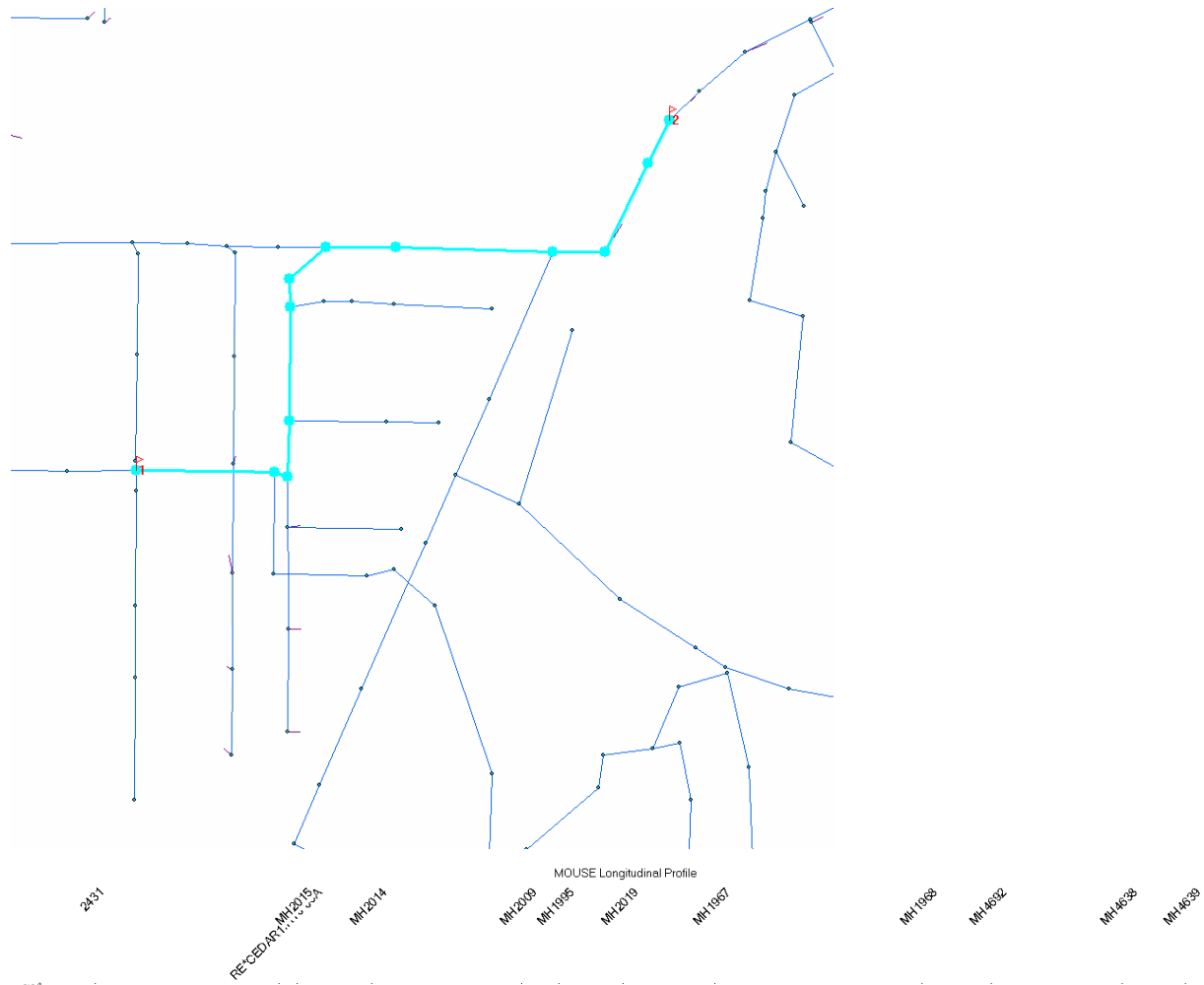

Deficiency 37A (drains through MH0825):

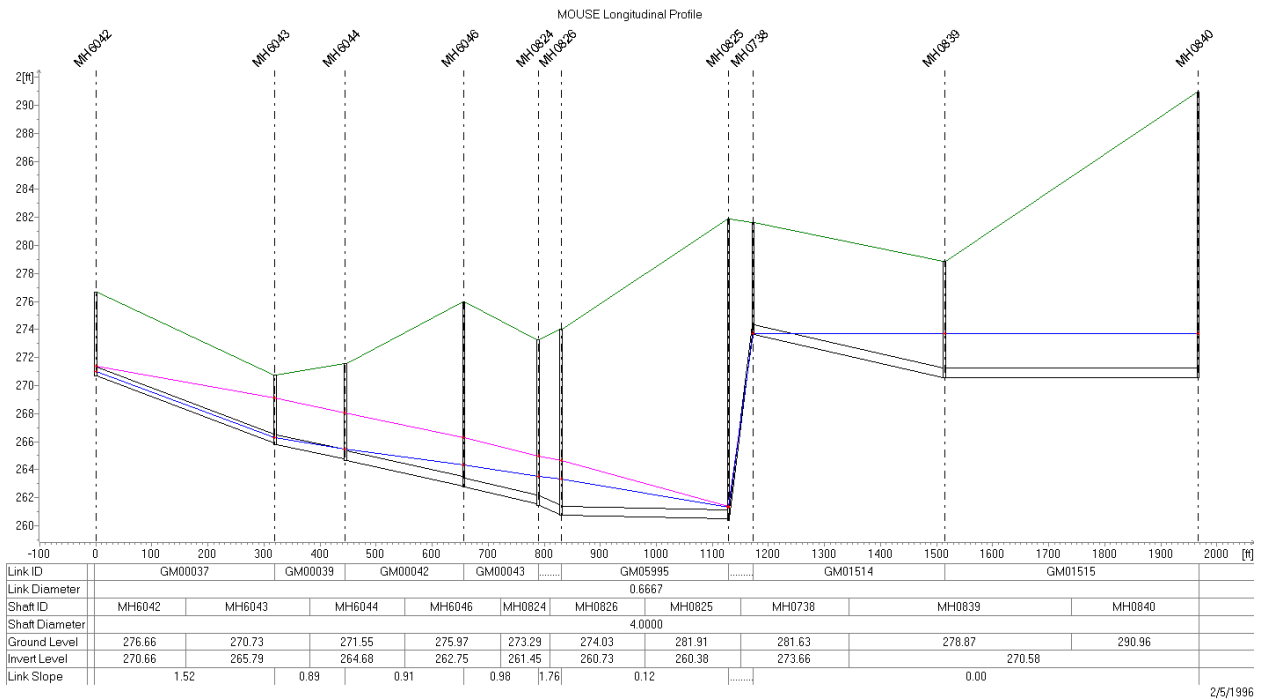
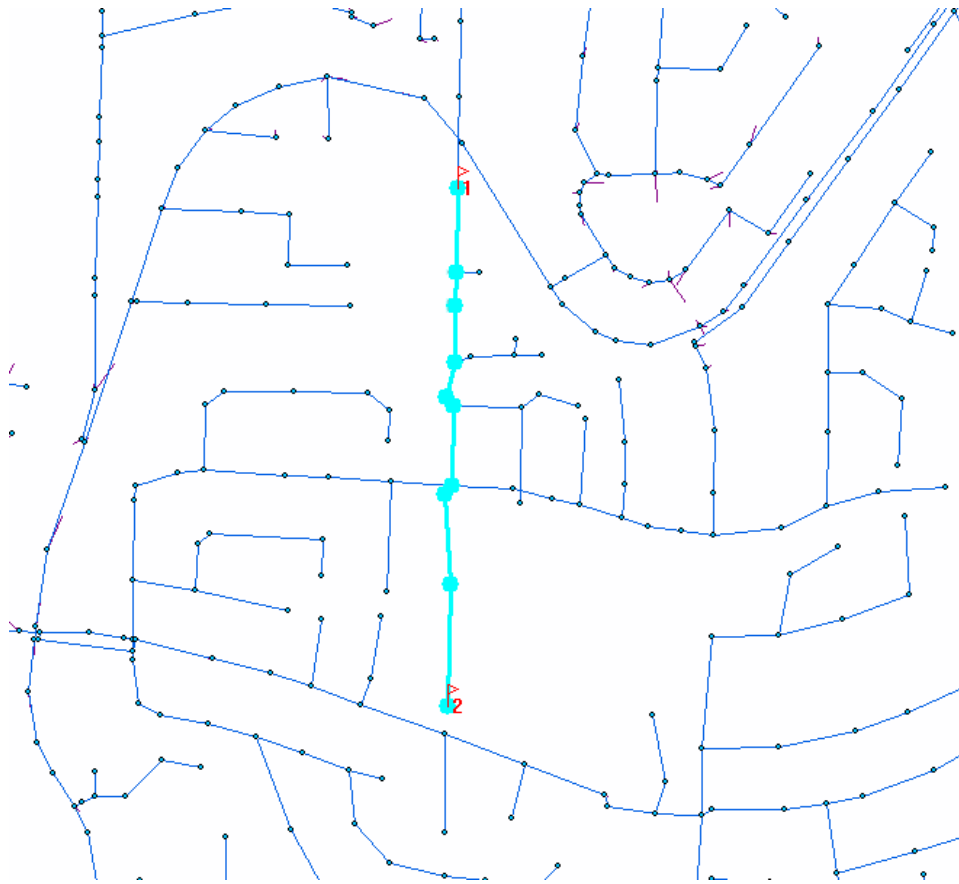

Deficiency 48A:

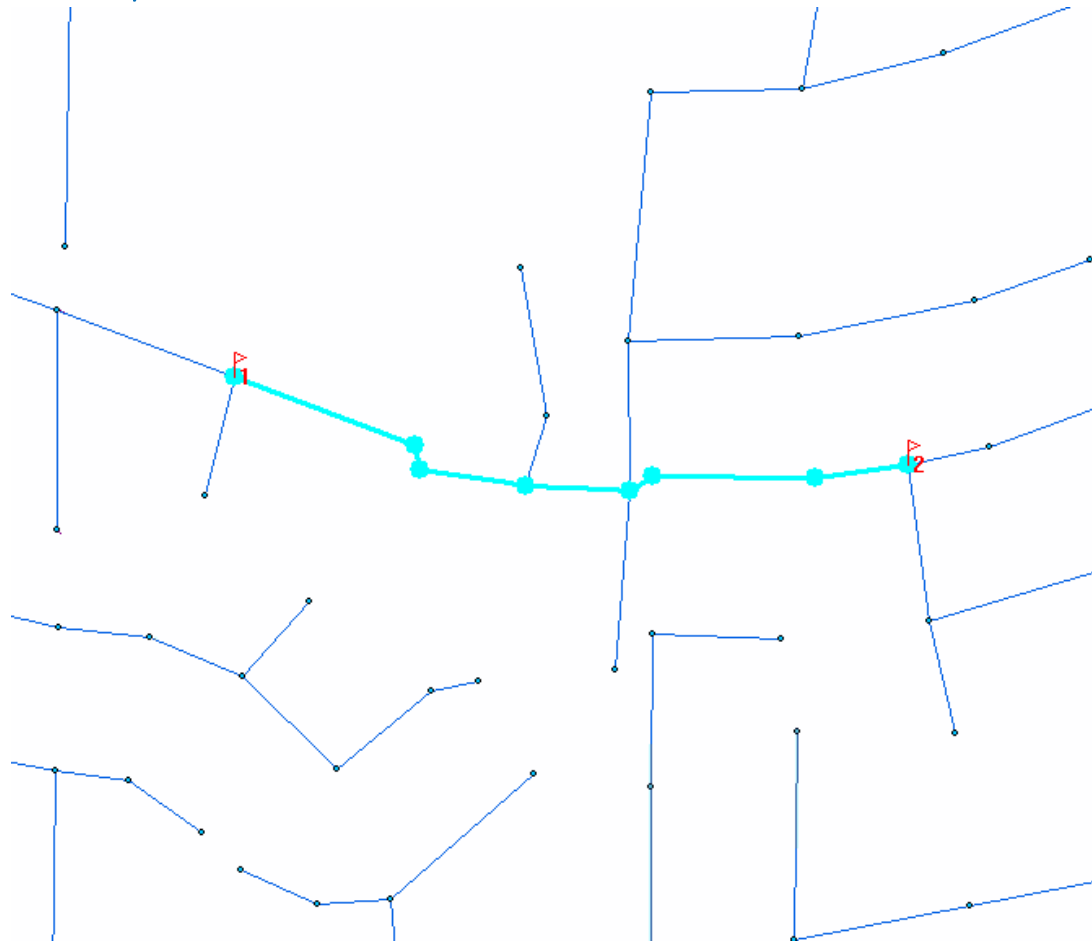

MOUSE Longitudinal Profile

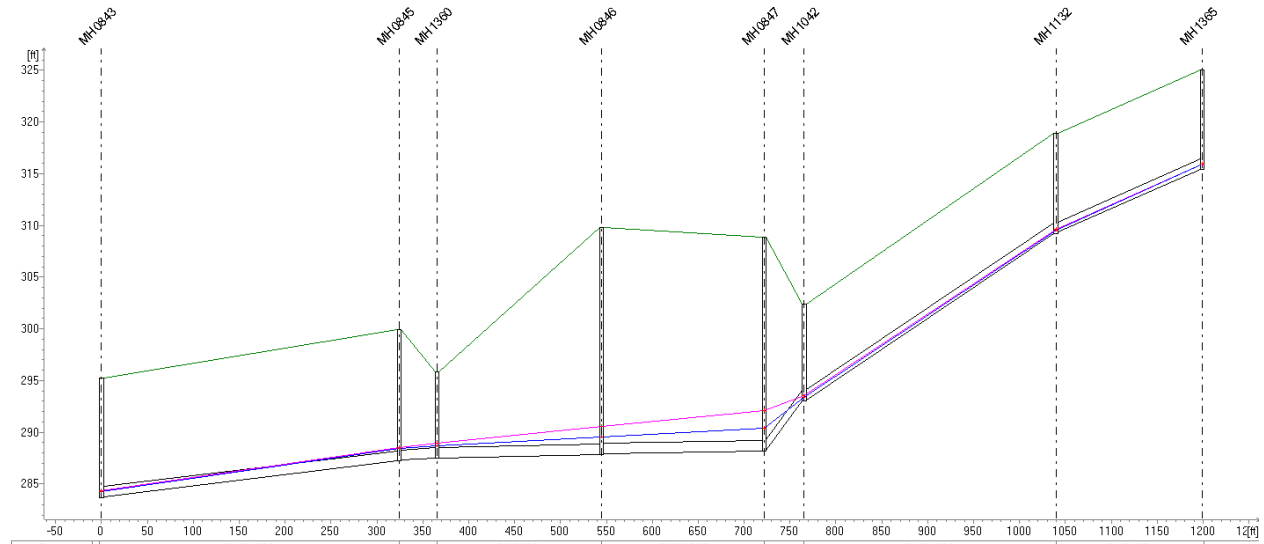

Link ID	GM01503		GM01504		GM01505		GM01923		GM01624	
Link Diameter	1.0000									
Shaft ID	MH0843	MH0845	MH1360	MH0846	MH0847	MH1042	MH1132	MH1365		
Shaft Diameter	4.0000									
Ground Level	295.28	299.90	295.81	309.82	308.88	302.42	318.89	325.06		
Invert Level	283.67	287.20	287.51	287.85	288.16	293.01	309.23	315.41		
Link Slope	1.09		0.80	0.19		0.17	11.16	5.91	3.88	

Deficiency 24A:

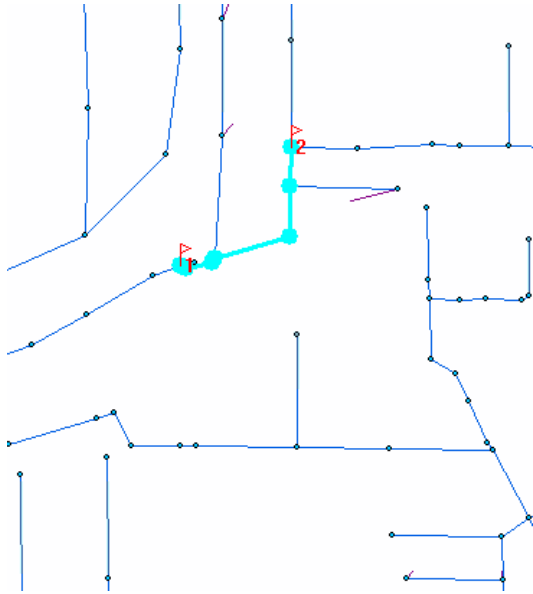

MOUSE Longitudinal Profile

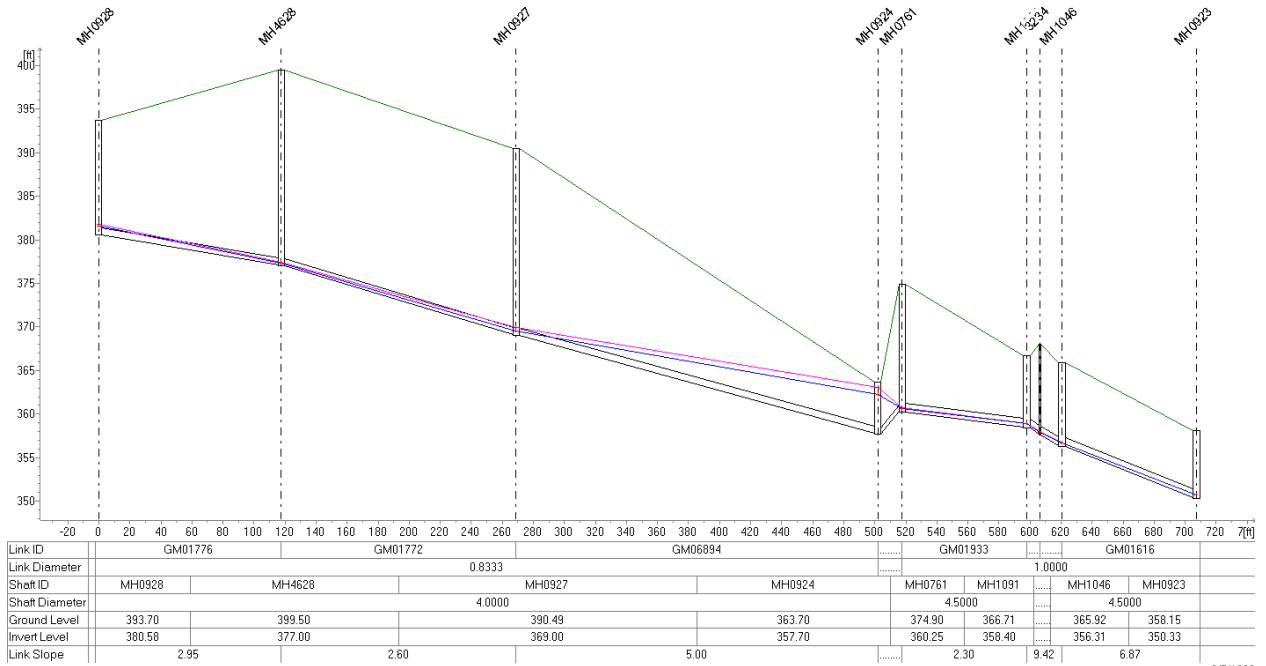

Deficiency 20A:

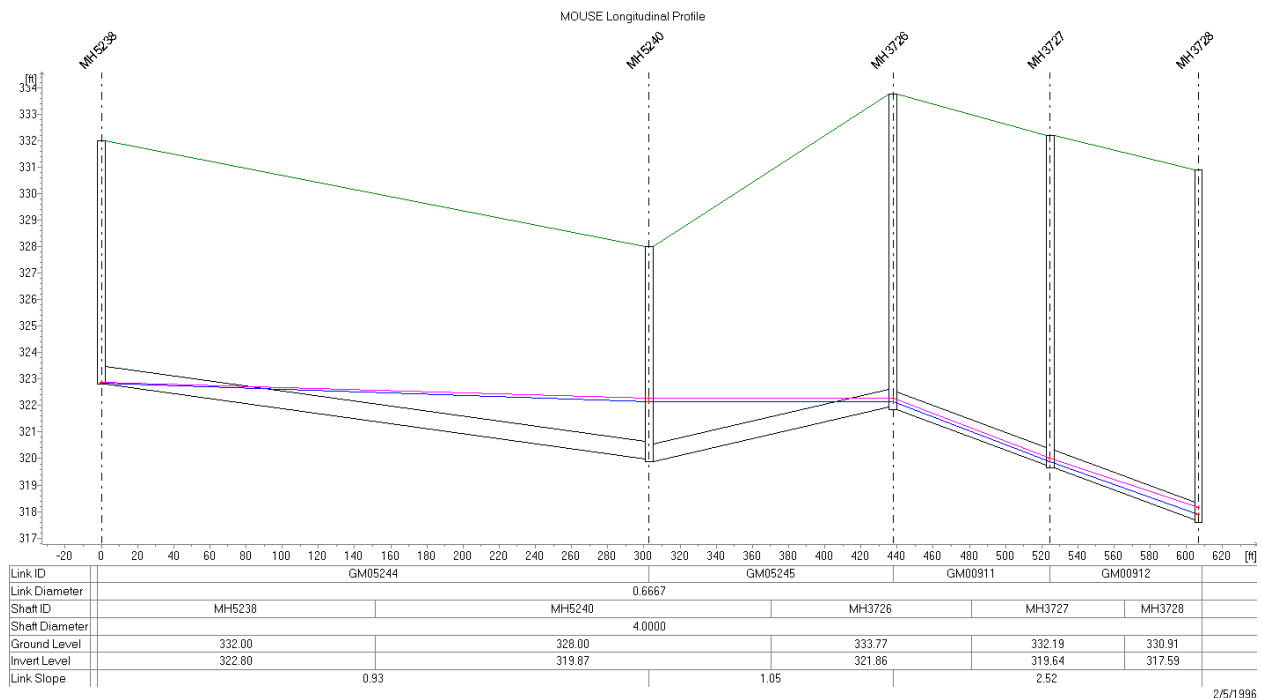
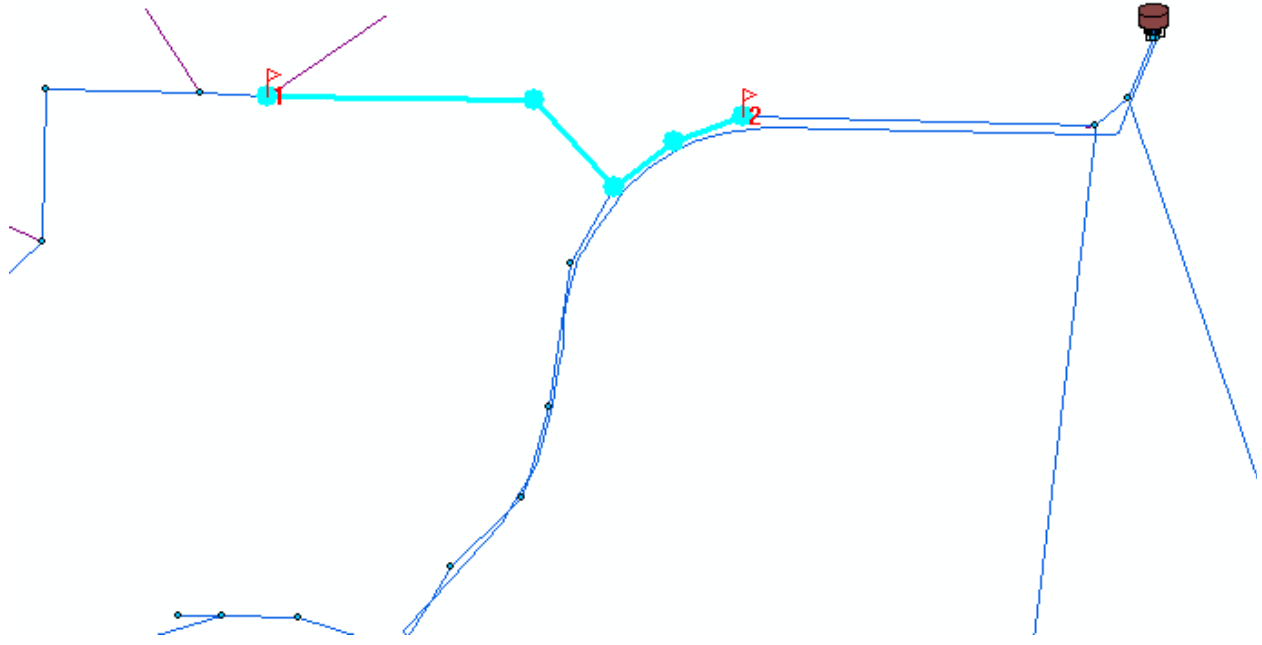

Deficiency 20B:

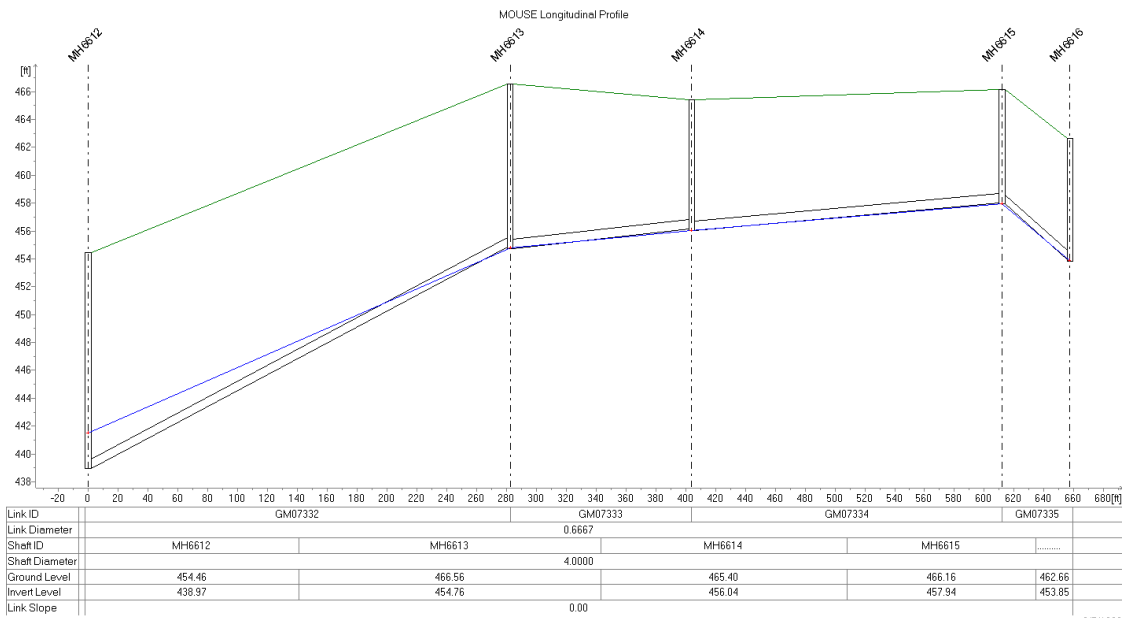
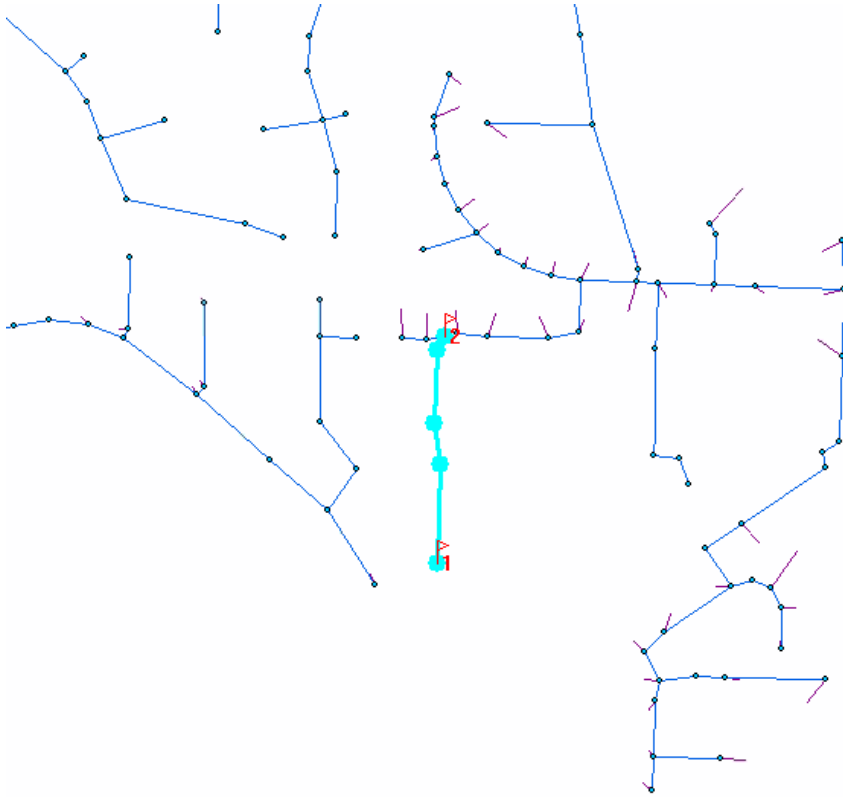

Deficiency 22A:

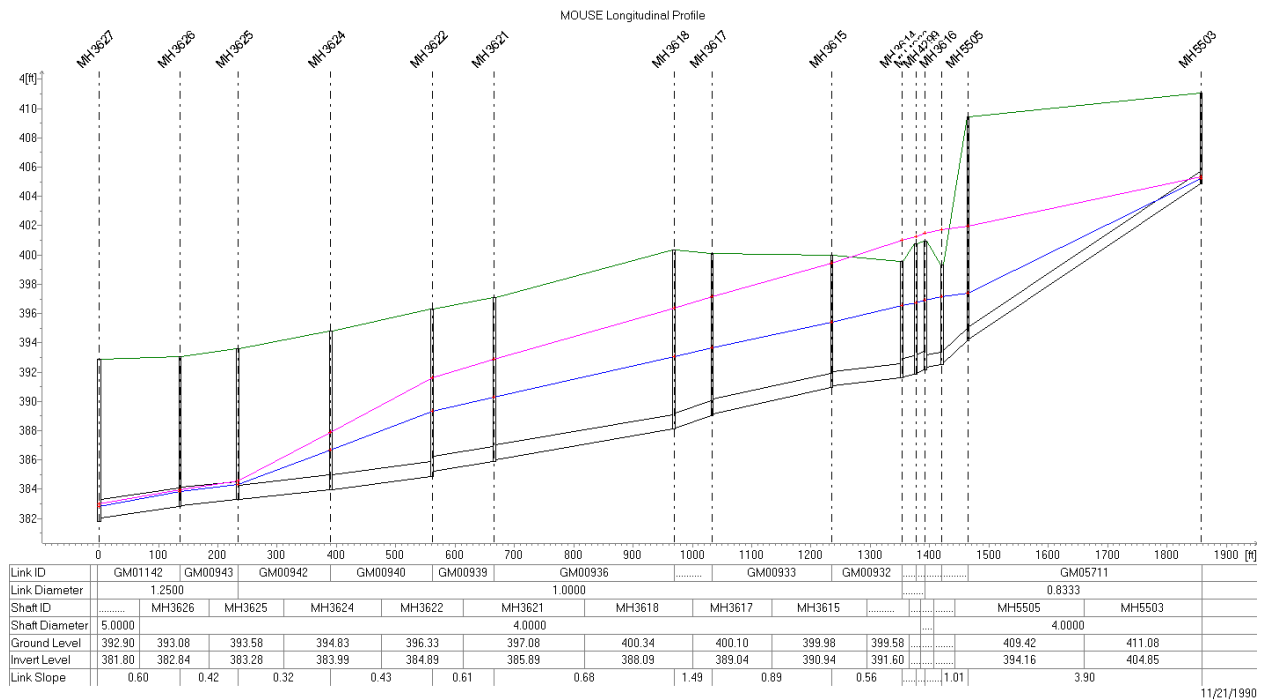
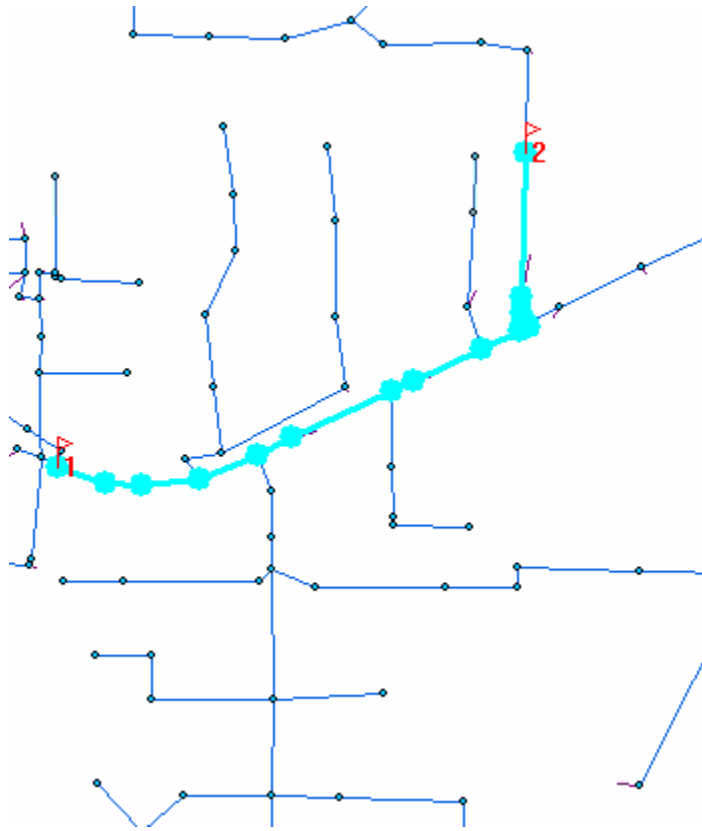

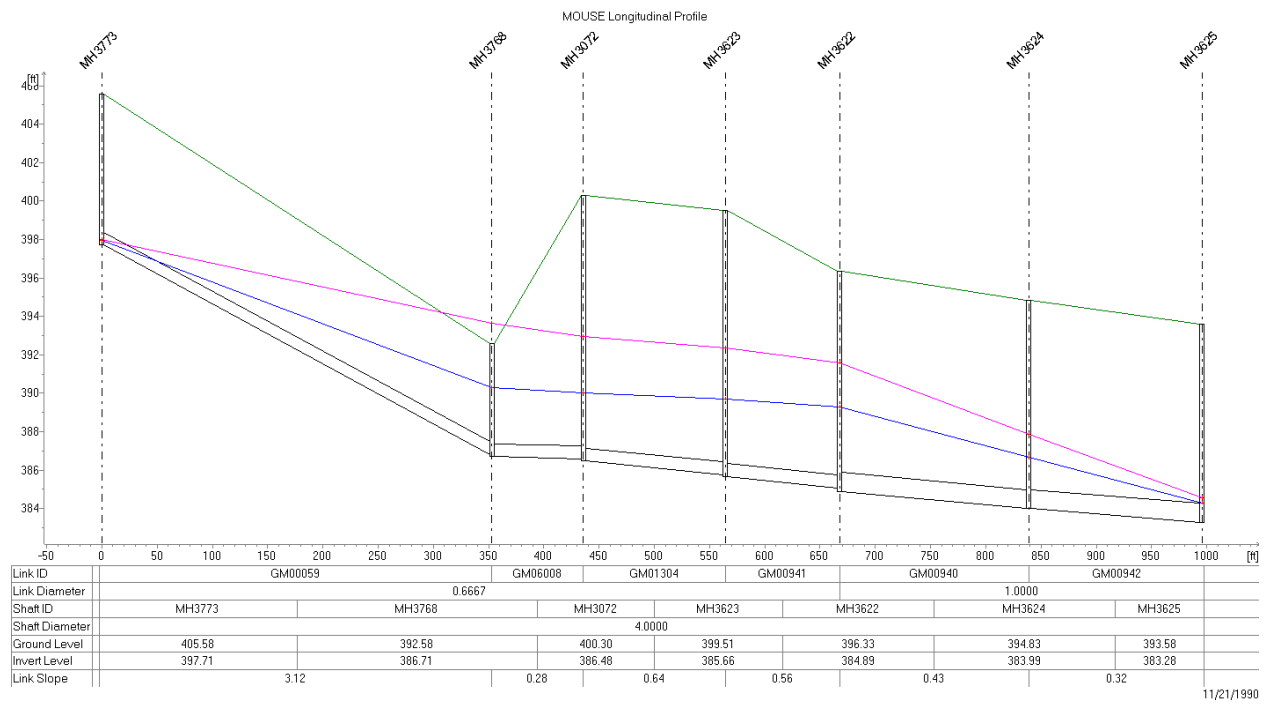
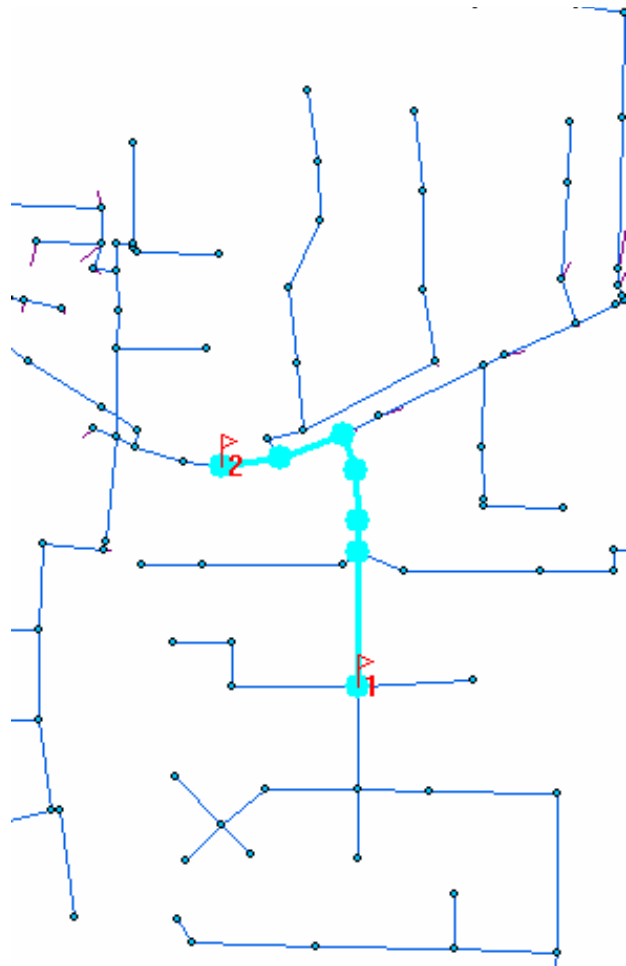

Deficiency 21A:

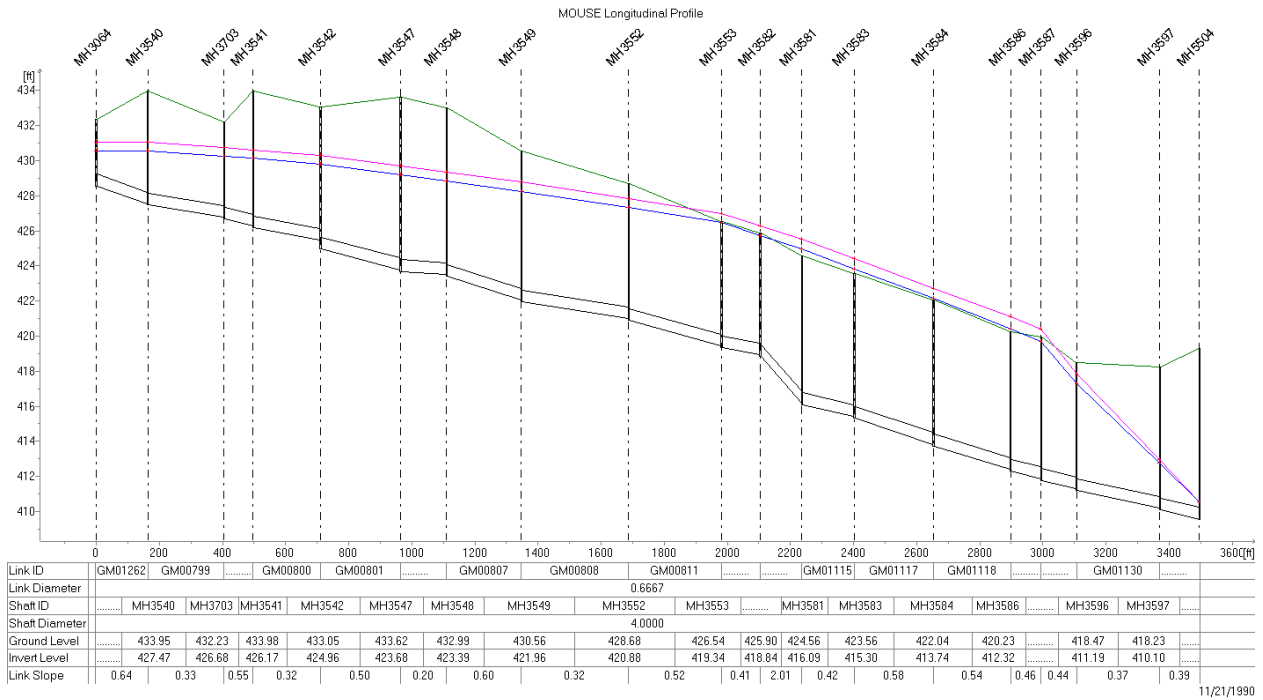
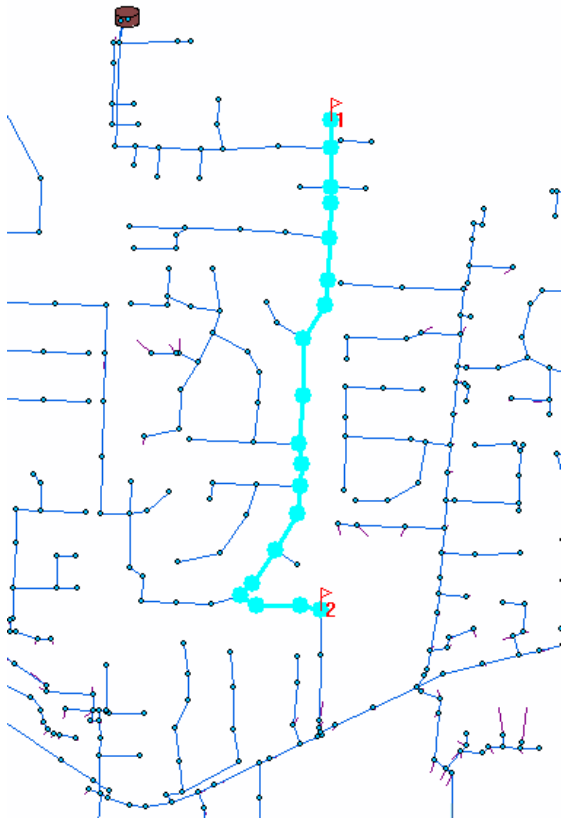

Deficiency 41A:

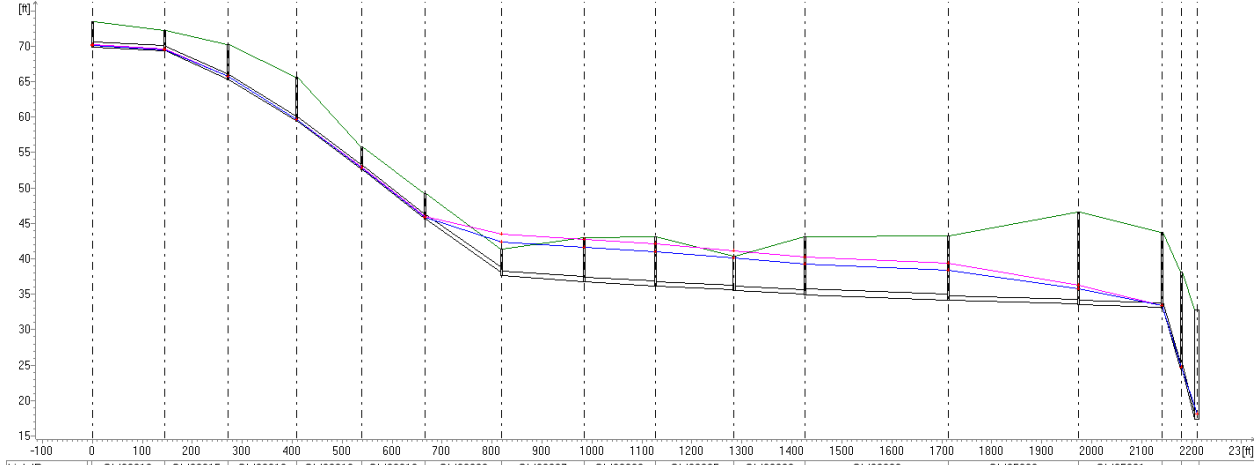
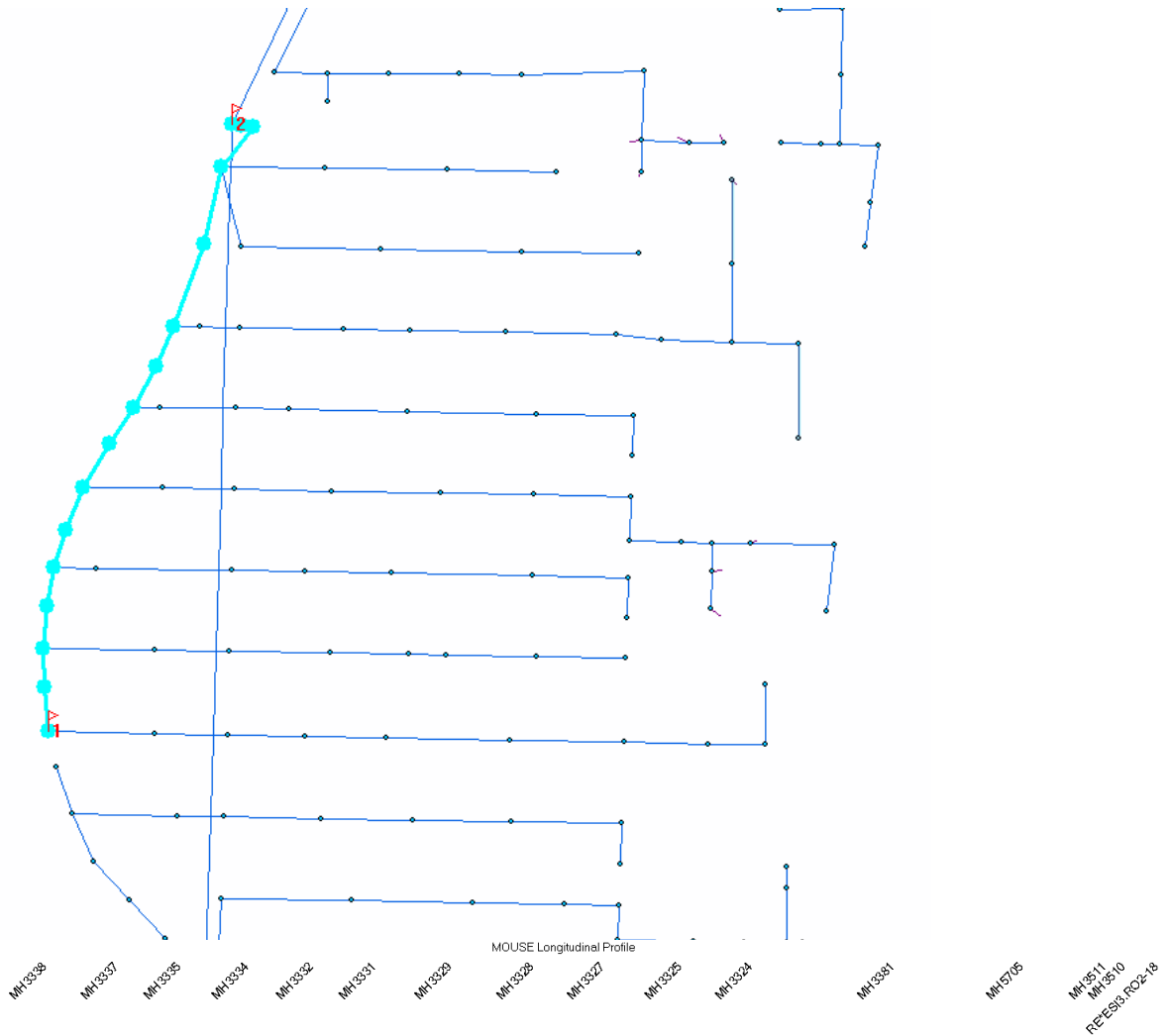

Link ID	GM03816	GM03815	GM03813	GM03812	GM03810	GM03809	GM03807	GM03806	GM03805	GM03803	GM03802	GM05922	GM05921	
Link Diameter						0.6667					0.8333		0.6667	0.8333
Shaft ID	MH3337	MH3335	MH3334	MH3332	MH3331	MH3329	MH3328	MH3327	MH3325	MH3324	MH3381	MH5705	MH3511	
Shaft Diameter	40000													
Ground Level	73.47	72.15	70.19	65.62	55.82	49.21	41.37	43.03	43.10	40.33	43.05	43.21	46.58	43.69
Invert Level	69.90	69.29	65.30	59.41	52.53	45.56	37.58	36.73	36.09	35.49	34.90	34.11	33.50	33.05
Link Slope	0.42	3.16	4.29	5.28	5.50	4.81	0.51	0.45	0.38	0.42	0.28	0.23	0.27	

Deficiency 23A:

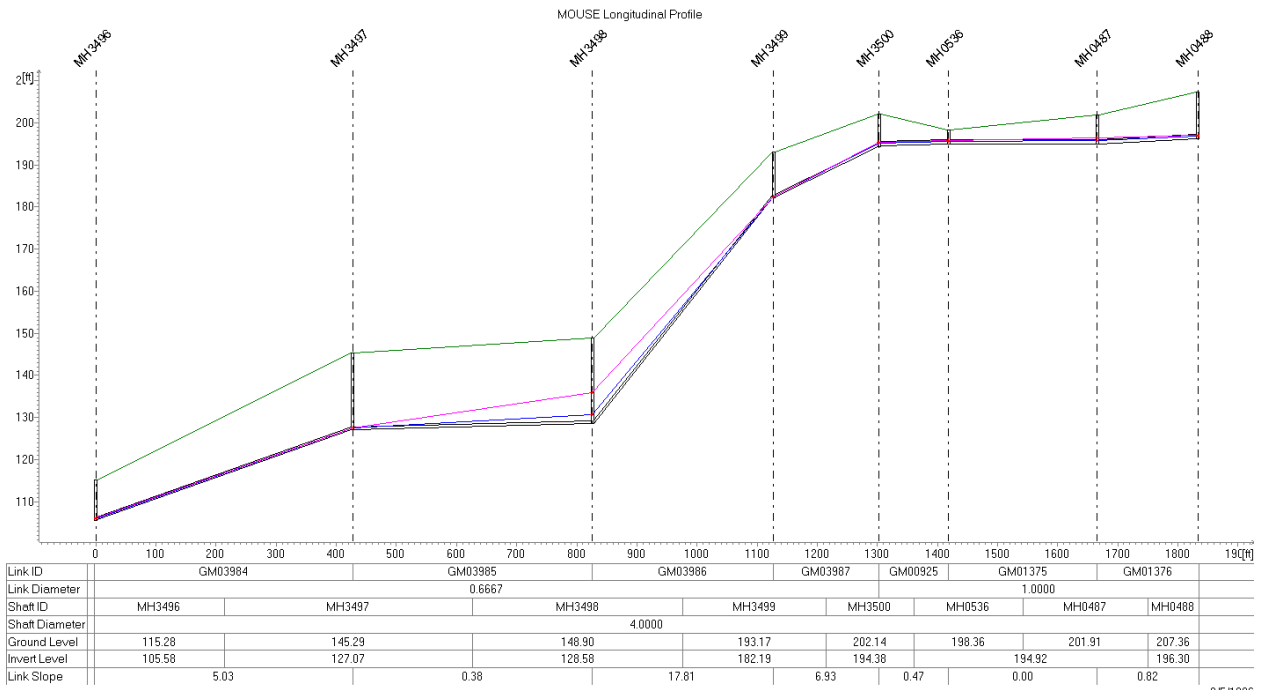
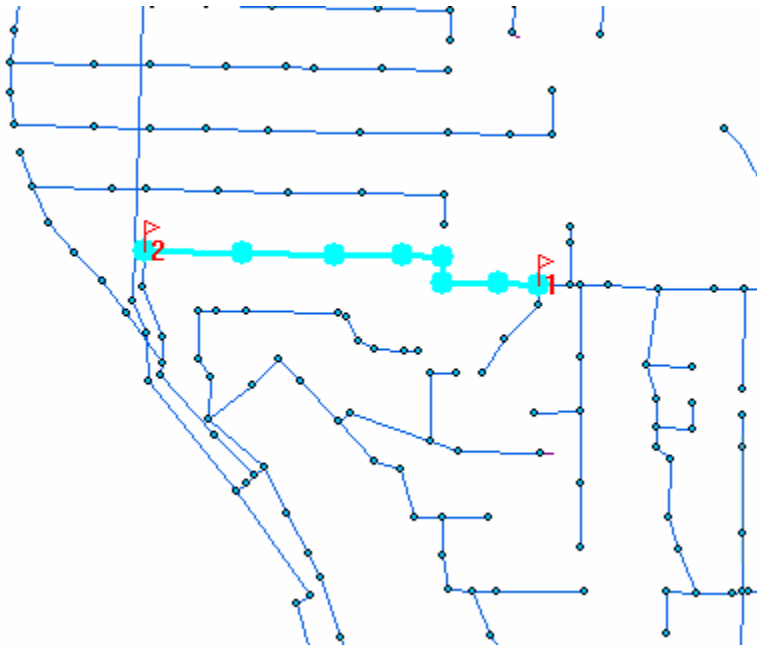

Deficiency 15A & 14A (just upstream):

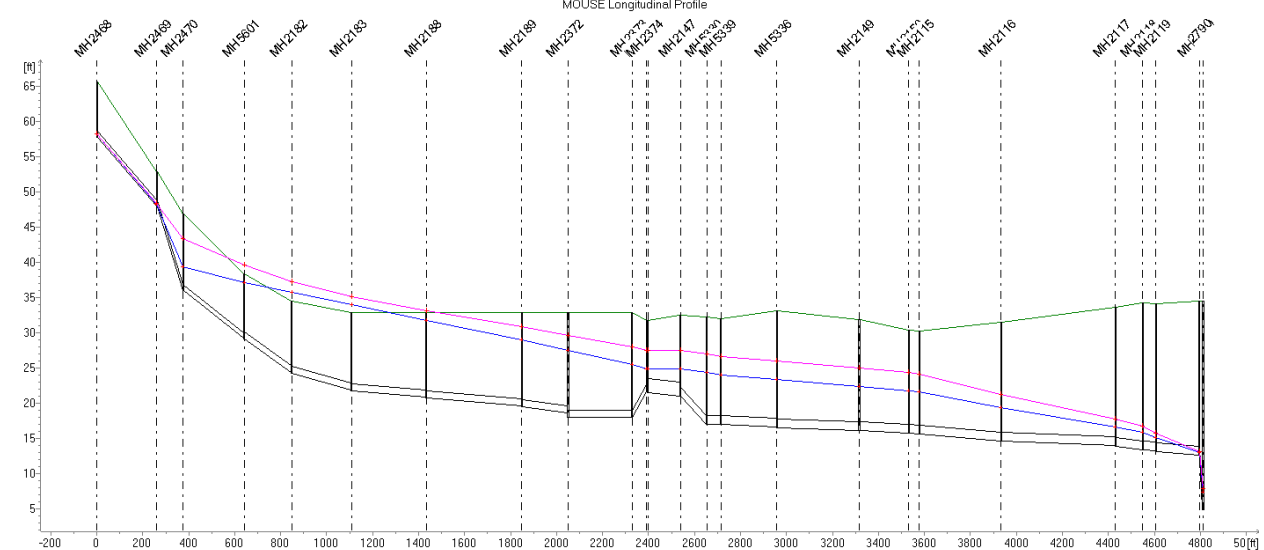
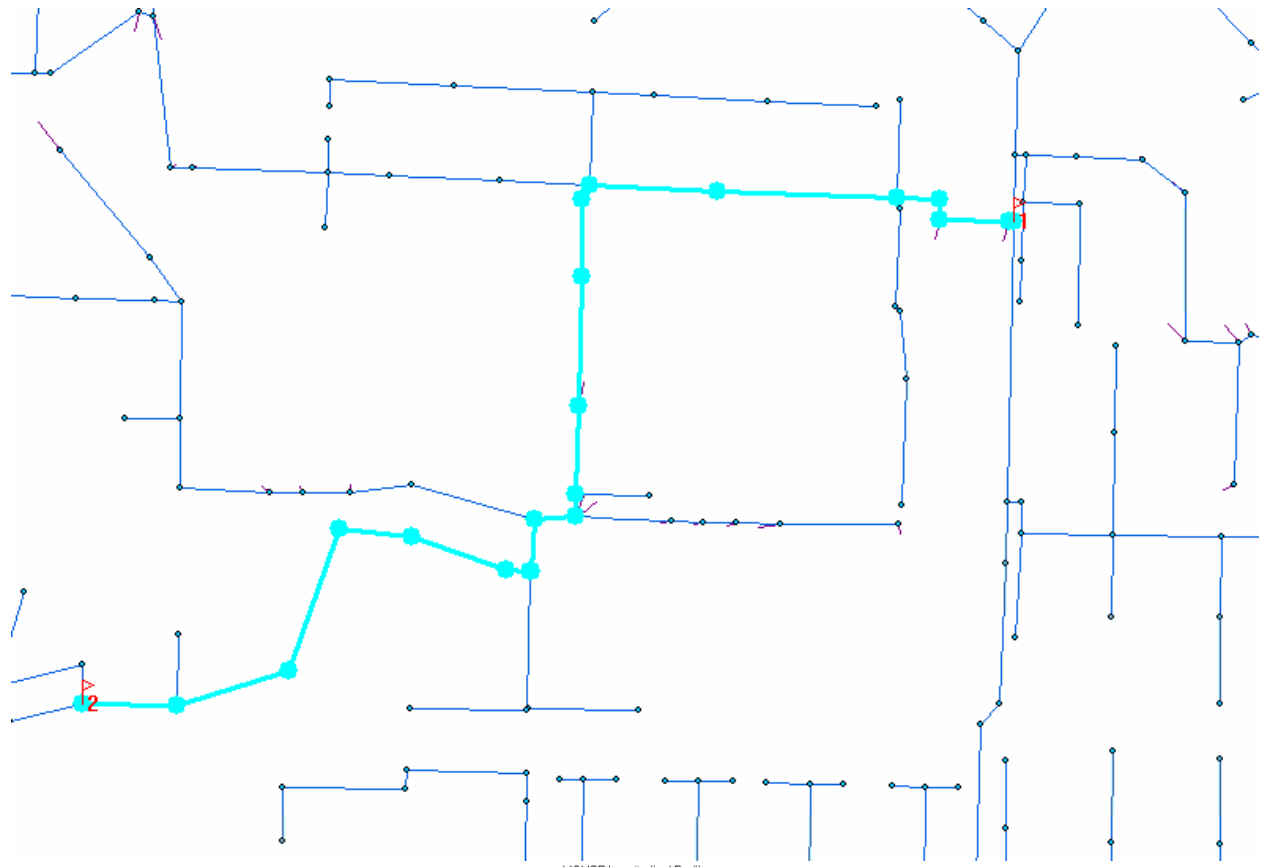

Link ID	GM03425	GM05824	GM03136	GM06874	GM03142	GM03144	GM05426	GM05423	GM03271	GM02857	GM02858								
Link Diameter	0.8333		1.0000				1.2500												
Shaft ID		MH2470	MH5601	MH2182	MH2183	MH2188	MH2189	MH2372		MH5336	MH2149	MH2115	MH2116	MH2117					
Shaft Diameter		4.0000				4.0000													
Ground Level	65.62	52.86	46.82	38.29	34.45	21.77		20.75	19.44	17.90	32.40	32.00	33.08	31.82	30.28	30.26	31.45	33.59	34.11
Invert Level	57.74	47.89	35.92	29.08	24.18	21.77		20.75	19.44	17.90	20.90	16.90	16.50	16.04	15.65	15.53	14.57	13.81	13.07
Link Slope	3.77	2.57	2.36								0.45	0.16	0.13	0.18	0.27		0.15	0.44	0.23

Deficiency BA:

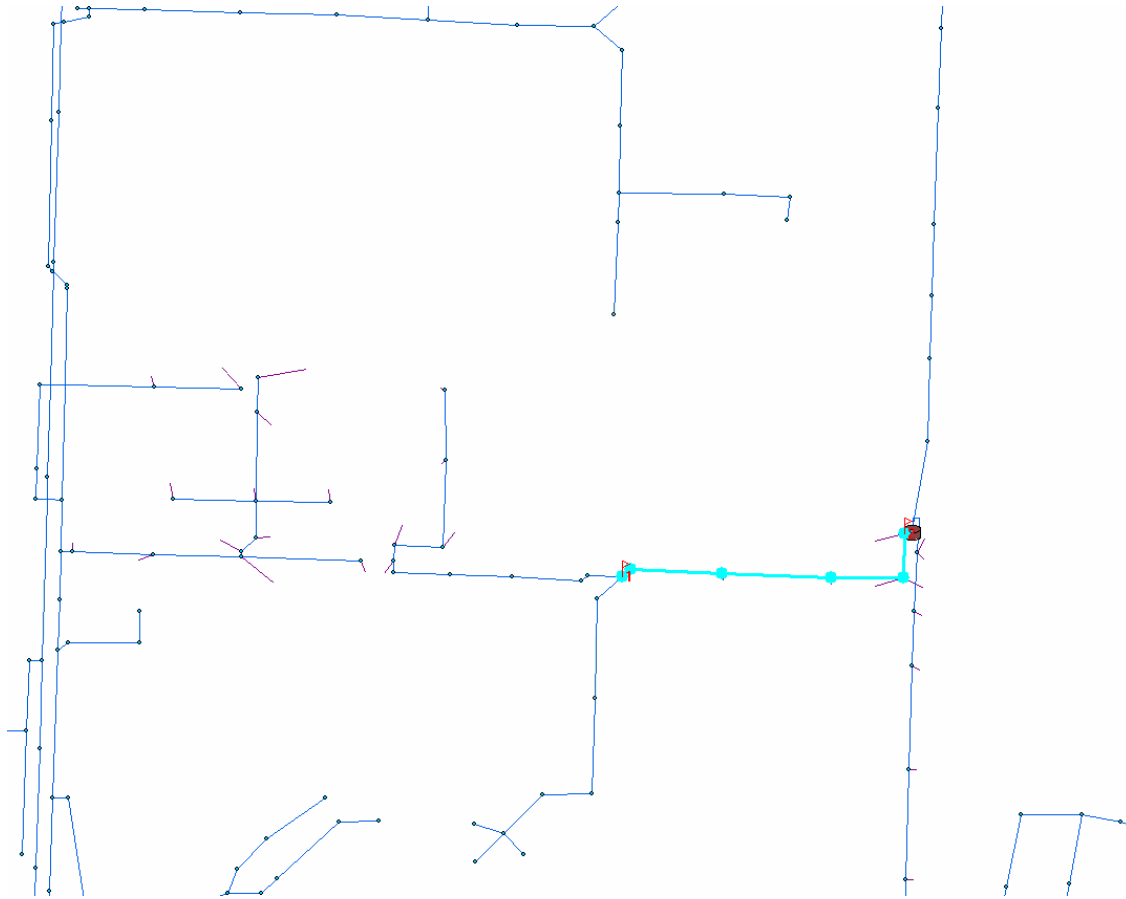

MOUSE Longitudinal Profile

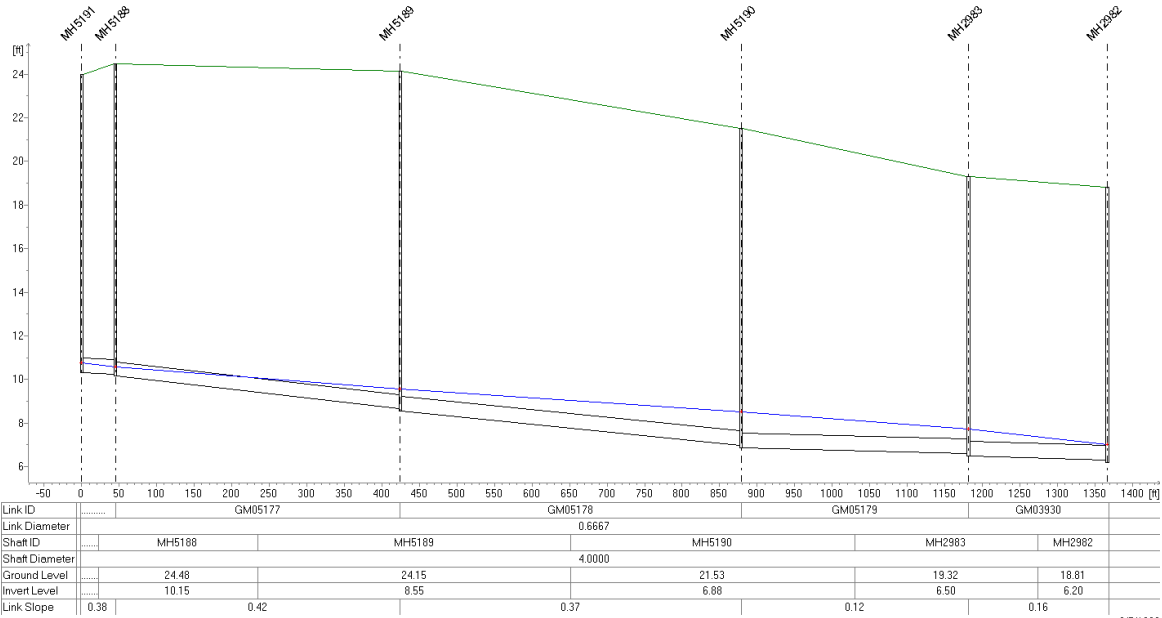

Deficiency 11A:

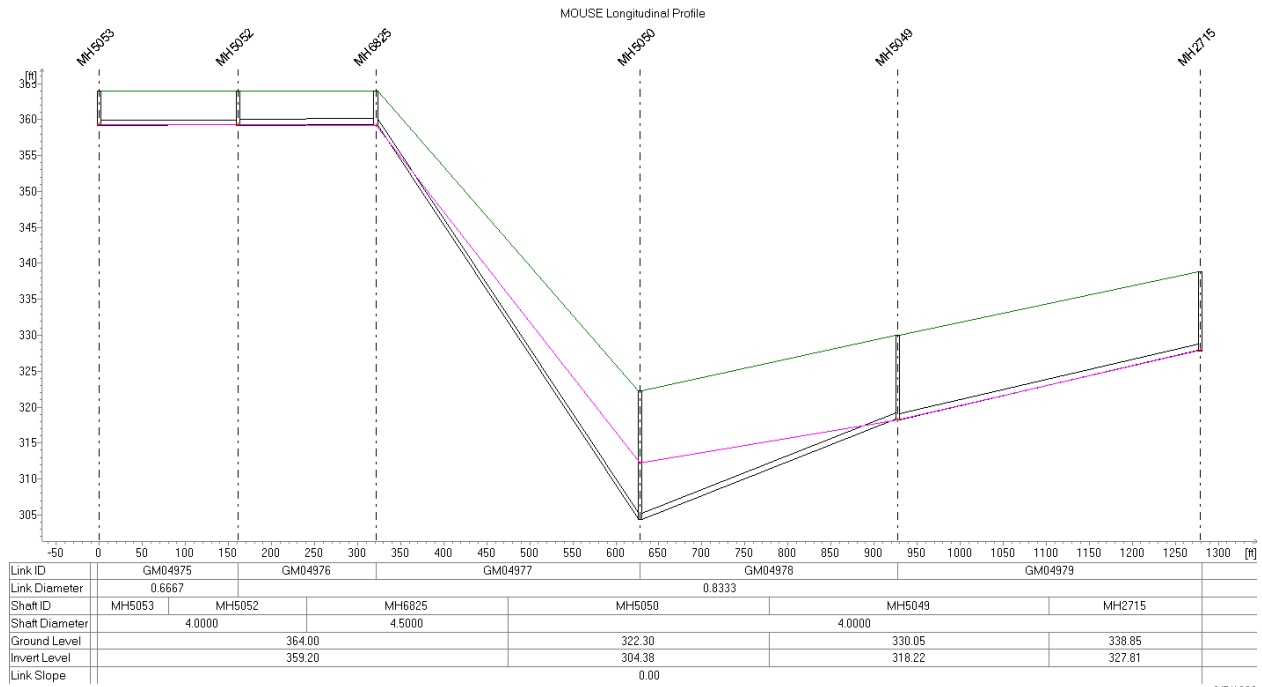
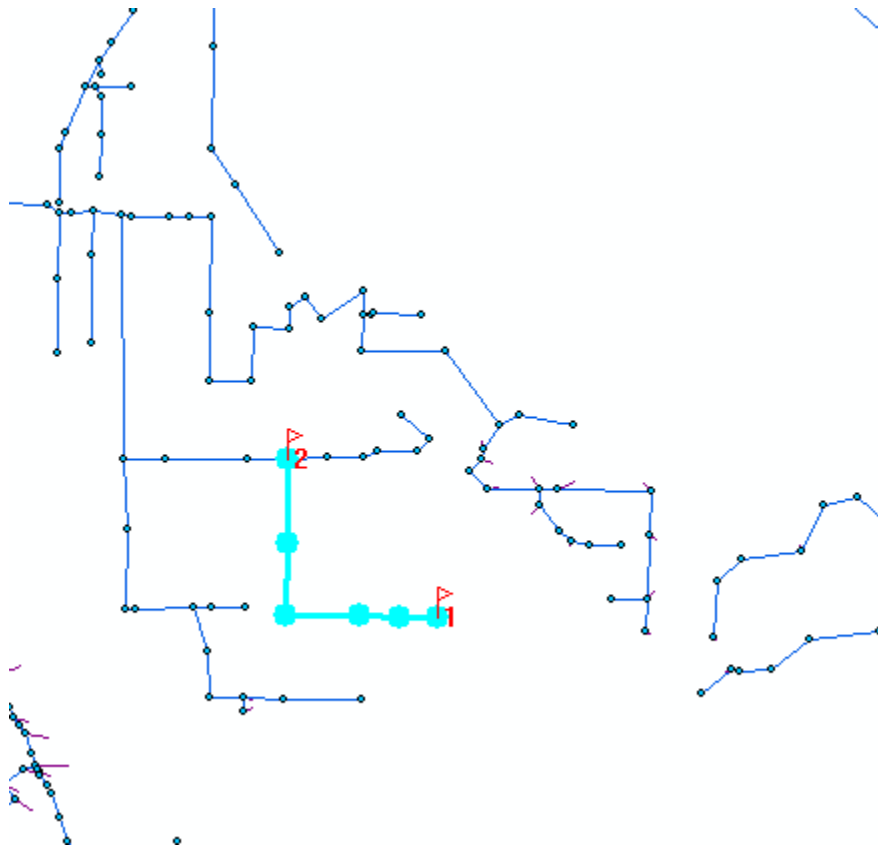

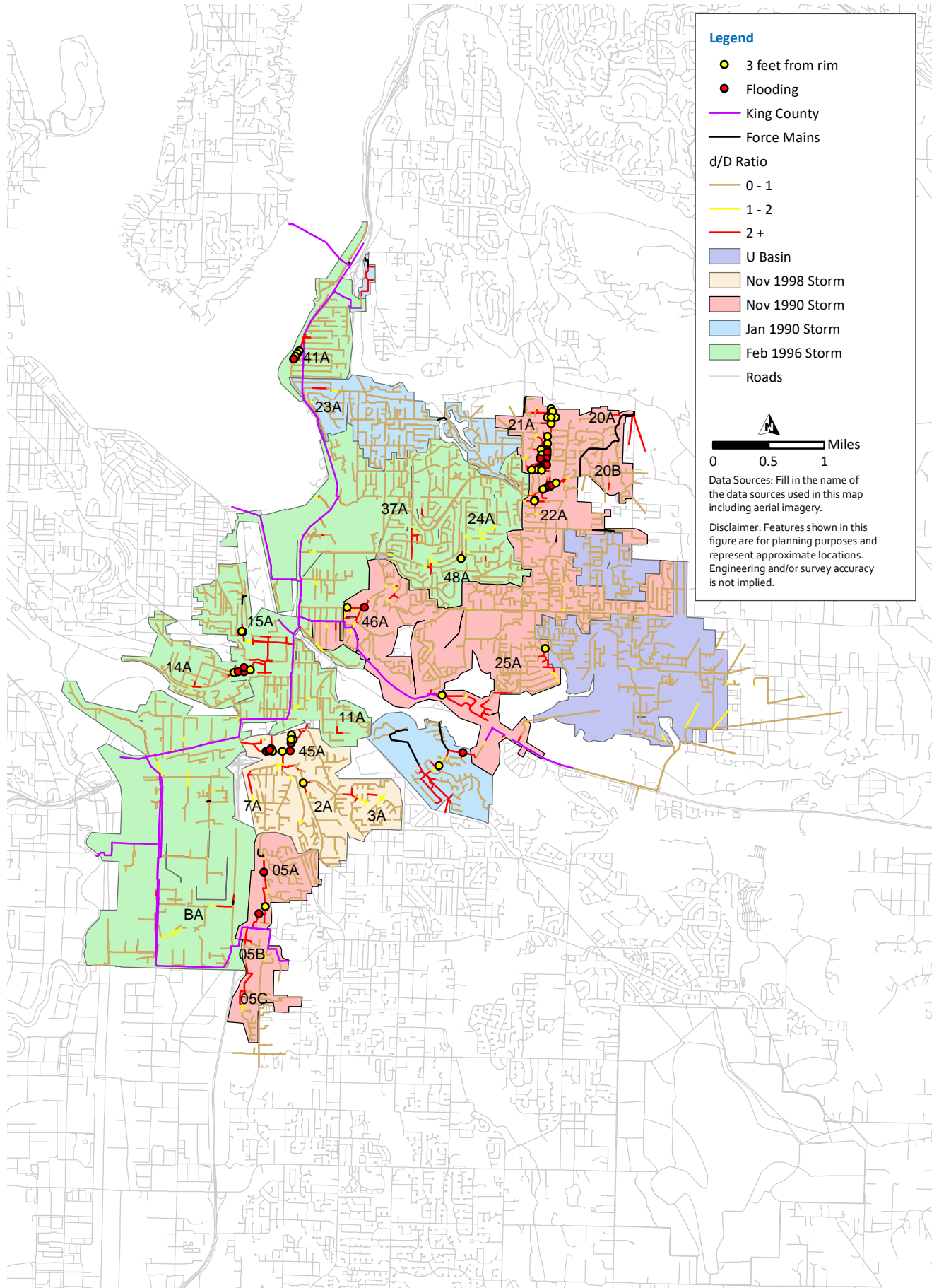

Legend

- 3 feet from rim
- Flooding
- King County
- Force Mains

d/D Ratio

- 0 - 1
- 1 - 2
- 2 +

- U Basin
- Nov 1998 Storm
- Nov 1990 Storm
- Jan 1990 Storm
- Feb 1996 Storm
- Roads

0 0.5 1 Miles

Data Sources: Fill in the name of the data sources used in this map including aerial imagery.

Disclaimer: Features shown in this figure are for planning purposes and represent approximate locations. Engineering and/or survey accuracy is not implied.

Deficiency 05B & 05C:

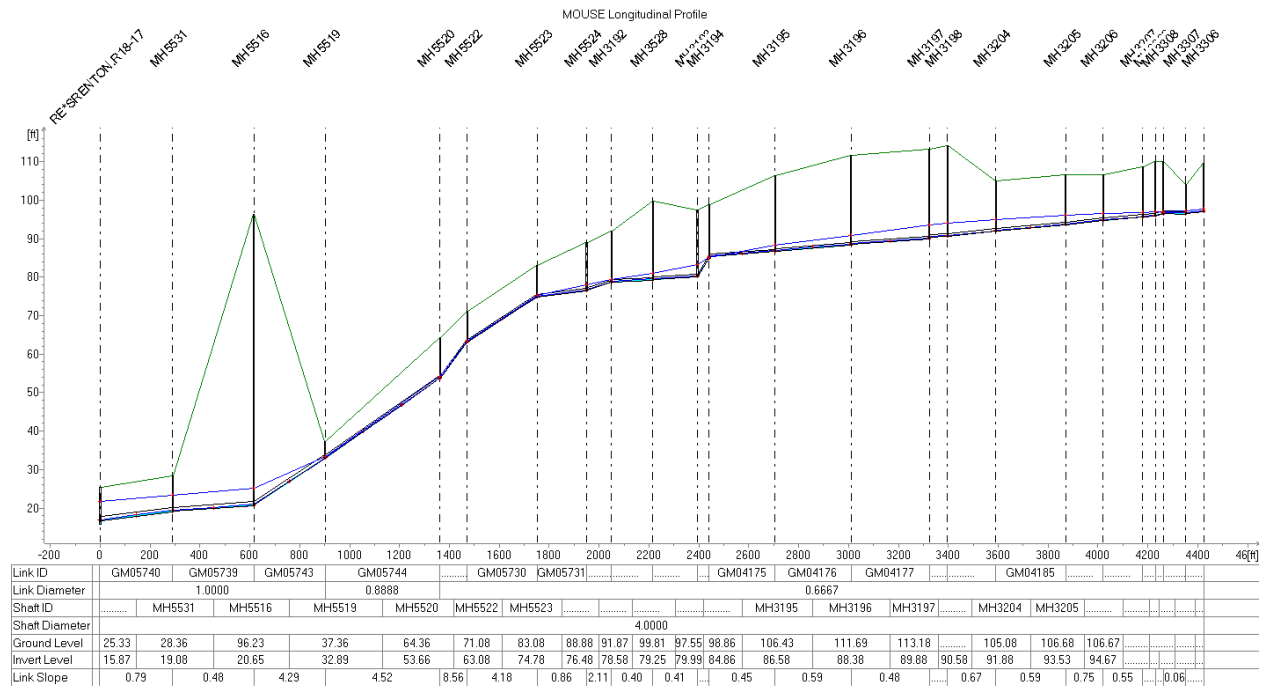
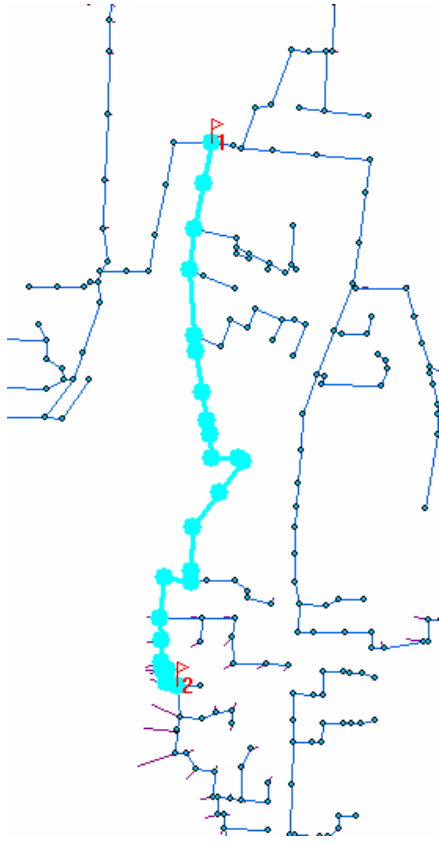

Deficiency 25A:

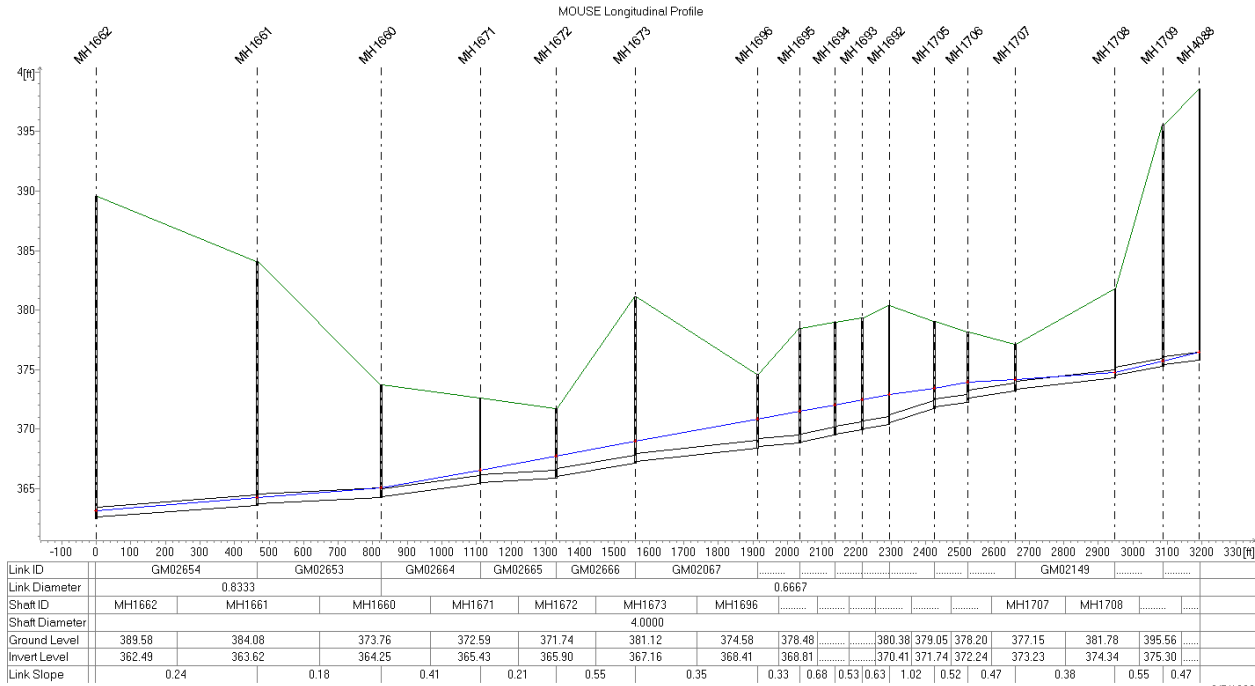
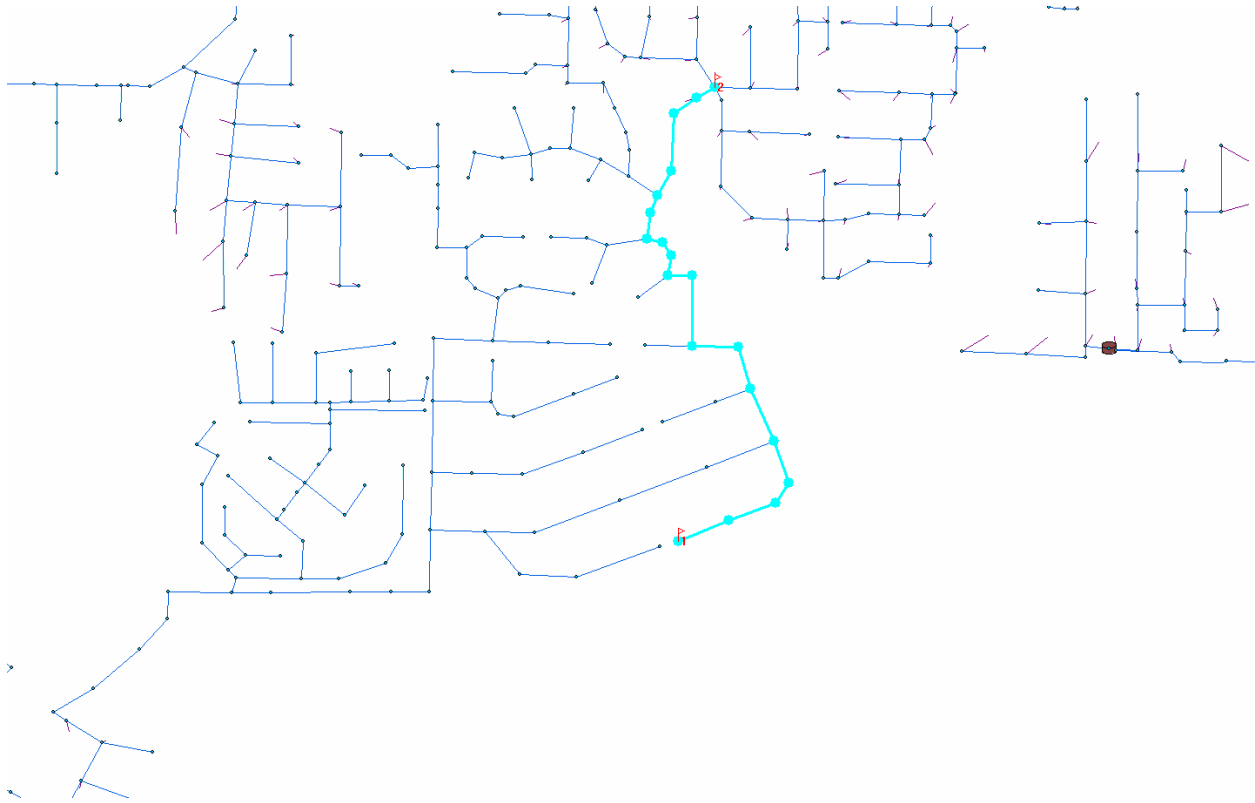

Appendix E

SERVICE AGREEMENTS

OAG-636-61
(Amended by Ord
#1274 - 4/7/61)

AGREEMENT FOR SEWAGE DISPOSAL

THIS AGREEMENT made and executed this 2nd day of July, 1961, between the CITY OF RENTON, a municipal corporation of the State of Washington, hereinafter referred to as the "City" and the MUNICIPALITY OF METROPOLITAN SEATTLE, a municipal corporation of the State of Washington, hereinafter referred to as "Metro,"

WITNESSETH:

WHEREAS, the public health, welfare and safety of the residents of the City and the residents of the metropolitan area require the elimination of existing sources of water pollution and the preservation of the fresh and salt water resources of the area; and

WHEREAS, growth of population, topographic conditions and preservation of water resources require that certain major sewage disposal works be constructed and operated and that the cities and special districts within the metropolitan area dispose of their sewage in accordance with a comprehensive plan for the metropolitan area; and

WHEREAS, Metro was established by vote of the people in the metropolitan area pursuant to Chapter 35.58 RCW for the purpose of performing the function of metropolitan sewage disposal, has adopted a comprehensive plan for the disposal of sewage from the metropolitan area and intends to develop the facilities needed to carry out such plan and to issue revenue bonds to finance such development; and

WHEREAS, to carry out the purposes of Metro and perform its authorized function and to provide for the disposal of sewage from the City into the metropolitan sewage disposal system it is necessary that a contract be now entered into establishing certain rights and duties of the parties incident thereto;

NOW, THEREFORE, in consideration of the mutual covenants contained herein, IT IS HEREBY AGREED as follows:

Section 1. Definition of Terms. The following words and phrases used in this contract shall have the meanings hereinafter set forth in this section:

- (a) The words "Comprehensive Plan" shall mean the Comprehensive Sewage Disposal Plan for the metropolitan area adopted in Resolution No. 23 of the Municipality of Metropolitan Seattle and as same may be hereafter amended from time to time in the manner required by law.
- (b) The words "Metropolitan Sewerage System" shall mean all of the facilities to be constructed, acquired or used by Metro as a part of the comprehensive Plan. The Metropolitan Sewerage System shall generally include sewage disposal facilities with capacity to receive sewage from natural drainage areas of approximately one thousand acres or more. The Metropolitan Sewerage System shall thus include trunk or interceptor sewer facilities extending to a point within each tributary, and natural drainage area, where not more than one thousand acres remain to be served beyond the upper terminus of such trunk or interceptor sewer.
- (c) The words "Local Sewerage Facilities" shall mean all facilities owned or operated by the Participant for the local collection of sewage to be delivered to the Metropolitan Sewerage System.
- (d) The words "Metropolitan Area" shall mean the area contained within the boundaries of the Municipality of Metropolitan Seattle as now or hereafter constituted.
- (e) The word "Participant" shall mean each city, town, county, sewer district, municipal corporation, person, firm or private corporation which shall dispose of any portion of its sanitary sewage into the Metropolitan Sewerage System and shall have entered into a contract with Metro providing for such disposal.
- (f) The words "Residential Customer" shall mean a single family residence billed by a Participant for sewerage charges.

Section 2. Delivery and Acceptance of Sewage. From and after July 1, 1962, the City shall deliver to the Metropolitan Sewerage System all of the sewage and industrial wastes collected by it and Metro shall accept the sewage and wastes delivered for treatment subject to such reasonable rules and regulations as may be adopted from time to time by the Metropolitan Council. Metro shall not directly accept sewage or wastes from any person, firm, corporation or governmental agency which is located within the boundaries of or is delivering its sewage into the Local Sewerage Facilities of any Participant without the written consent of such Participant.

Section 3. Construction of Facilities. Metro shall construct, acquire or otherwise secure the right to use all facilities required for the disposal of sewage delivered to Metro pursuant to this Agreement and shall perform all services required for the maintenance, operation, repair, replacement or improvement of the Metropolitan Sewerage System, including any additions and betterments thereto.

Section 4. Connection of Local Sewerage Facilities to the Metropolitan Sewerage System. Local Sewerage Facilities of the City shall be connected to the Metropolitan Sewerage System at such time as any portion of the Metropolitan Sewerage System shall be available to receive sewage collected by such facilities. Metro shall, at its sole expense, connect those Local Sewerage Facilities of the City which are not in existence or which shall be constructed in accordance with the rules and regulations of Metro prior to the availability of the Metropolitan Sewerage System. Local Sewerage Facilities constructed after the Metropolitan Sewerage System shall have been made available to the area served by such Local Sewerage Facilities shall be connected to the Metropolitan Sewerage System at the expense of the Participant in accordance with the rules and regulations of Metro.

Section 5. Payment for Sewage Disposal. For the disposal of sewage collected by the City and delivered to Metro, the City shall pay to Metro on or before the last day of each month during the term of this agreement, commencing with the month of July, 1962, a sewage disposal charge determined as provided in this Section 5.

1. For the quarterly periods ending March 31, June 30, September 30 and December 31 of each year every Participant shall submit a written report to Metro setting forth (a) the number of Residential Customers billed by such Participant for local sewerage charges as of the last day of the quarter, (b) the total number of all customers billed by such Participant as of such day and (c) the total water consumption during such quarter for all customers billed by such Participant other than Residential Customers. The quarterly water consumption report shall be taken from water meter records and may be adjusted to exclude water which does not enter the sanitary facilities of a customer. Where actual sewage flow from an individual customer is metered, the metered sewage flows shall be reported in lieu of adjusted water consumption. The total quarterly water consumption report in cubic feet shall be divided by 2,700 to determine the number of Residential Customer equivalents represented by each Participant's customers other than single family residences. The first report shall cover the quarterly period ending December 31, 1960 and shall be submitted on or before March 1, 1961. Succeeding reports shall be made for each quarterly period thereafter and shall be submitted within thirty (30) days following the end of the quarter. Metro shall maintain a permanent record of the quarterly customer reports from each Participant.

2. To form a basis for determining the monthly sewage disposal charge to be paid by each Participant during any particular quarterly period Metro shall ascertain the number of Residential Customers and Residential Customer equivalents of each Participant for each such quarterly period beginning with the July-September quarter of the year 1962. This determination shall be made by taking the sum of the actual number of Residential Customers reported as of the last day of the next to the last preceding quarter and the average number of Residential Customer equivalents per quarter reported for the four quarters ending with said next to the last preceding quarter, adjusted to eliminate any Residential Customers or Residential Customer equivalents whose sewage is delivered to a governmental agency other than Metro or other than a Participant for disposal outside of the Metropolitan area.

3. For the period from July 1, 1962 to December 31, 1963, the monthly rate for each Residential Customer and Residential Customer equivalent of the City shall be Two dollars (\$2.00) and the monthly sewage disposal charge to be paid by each Participant to Metro shall be obtained by multiplying the number of Residential Customers and Residential Customer equivalents of the Participant as determined in subparagraph 2 of this section by the monthly rate of Two Dollars.

4. For each calendar year after the year 1963, the monthly sewage disposal charge payable to Metro shall be determined as follows:

a) Prior to July 1st of each year Metro shall determine its total monetary requirements for the disposal of sewage during the next succeeding calendar year. Such requirements shall include the cost of administration, operation, maintenance, repair and replacement of the Metropolitan Sewerage System, establishment and maintenance of necessary working capital and reserves, the requirements of any resolution providing for the issuance of revenue bonds of Metro to finance the acquisition, construction or use of sewerage facilities, plus not to exceed 1% of the foregoing requirements for general administrative overhead costs.

b) To determine the monthly rate per Residential Customer or Residential Customer equivalent to be used during said next succeeding calendar year, the total monetary requirements for disposal of sewage as determined in subparagraph 4 (a) of this section shall be divided by twelve and the resulting quotient shall be divided by the total number of Residential Customers and Residential Customer equivalents of all Participants ascertained in accordance with subparagraph 2 of this section for the October-December quarter preceding said July 1st; provided, however, that the monthly rate shall not be less than Two dollars (\$2.00) per month per Residential Customer or Residential Customer equivalent at any time during the period ending July 31, 1972.

c) The monthly sewage disposal charge paid by each Participant to Metro shall be obtained by multiplying the monthly rate by the number of Residential Customers and Residential Customer equivalents of the Participant determined as provided in Paragraph 2 of this section. An additional charge may be made for sewage or wastes of unusual quality or composition requiring special treatment, or Metro may require pretreatment of such sewage or wastes. An additional charge may be made for quantities of storm or ground waters entering those Local Sewerage Facilities which are constructed after January 1, 1961 in excess of the minimum standard established by the general rules and regulations of Metro.

5. A statement of the amount of the monthly sewage disposal charge shall be submitted by Metro to each Participant on or before the first day of each month during the term of this agreement commencing with the month of July 1962 and payment of such charge shall be due on the last day of such month. If any charge or portion thereof due to Metro shall remain unpaid for fifteen days following its due date, the Participant shall be charged with and pay to Metro interest on the amount unpaid from its due date until paid at the rate of 6% per annum, and Metro may, upon failure to pay such amount, enforce payment by any remedy available at law or equity.

6. The City irrevocably obligates and binds itself to pay its sewage disposal charge out of the gross revenues of the combined water and sewerage system of the City. The City further binds itself to establish, maintain and collect rates and charges for water and for sewage disposal service which will at all times be sufficient to pay all costs of maintenance and operation of the combined water and sewerage system of the City, including the sewage disposal charge payable to Metro hereunder, and sufficient to pay the principal of and interest on any revenue bonds of the City which shall constitute a charge upon such gross revenue. It is recognized by Metro and the City that the sewage disposal charge paid by the City to Metro shall constitute an expense of maintenance and operation of the combined water and sewerage system of the City. The City shall provide in the issuance of future water and sewer revenue bonds of the City that expenses of maintenance and operation of the combined water and sewerage system of the City shall be paid before payment of principal and interest of such bonds. It is further recognized that the City shall have the right to fix its own schedule of water and sewerage rates and charges, provided that same shall produce revenue sufficient to meet the covenants contained in this agreement.

Section 6. Responsibility of Participant. Each Participant shall be responsible for the delivery to the Metropolitan Sewerage System of sewage collected by such Participant, for the construction, maintenance and operation of Local Sewerage Facilities, and for the payment of all costs incident to the collection of such sewage and its delivery to the Metropolitan Sewerage System.

Section 7. Records. Permanent books and records shall be kept by Metro of the rates established, the volumes of sewage delivered and discharged into the Metropolitan Sewerage System wherever such volumes are measured and the number of Residential Customers and Residential Customer equivalents reported by each Participant, in addition to complete books of account showing all costs incurred in connection with the Metropolitan Sewerage System. Such records shall be maintained beginning with the commencement of operation of any part of the Metropolitan Sewerage System.

Section 8. Development of Metropolitan Sewerage System. It is contemplated that the Metropolitan Sewerage System will be developed in stages and the nature of facilities to be constructed, acquired or used and the time of such construction, acquisition or use shall be determined by Metro, it being contemplated that Metro shall ultimately provide sewage disposal service for the entire Metropolitan Area.

Section 9. Use of Facilities Owned or Operated by the City. Effective July 1, 1962, or such earlier date as may be mutually agreed upon (hereinafter called "takeover date"), Metro shall have the exclusive right to use and the duty to maintain, operate, repair and replace the facilities owned by the City which are described in Exhibit "A" attached hereto and by this reference made a part hereof, subject to the continued availability of such facilities to receive, transport or treat sewage delivered by the City. From and after the takeover date Metro shall acquire, construct, maintain, operate, repair and replace all facilities now or hereafter acquired for the treatment and disposal of sewage delivered by the City and the City shall make payment for such treatment and disposal as provided in Section 5 of this Agreement.

For the privilege of using the facilities described in Exhibit "A" Metro shall pay to the City the total amount of One hundred twenty-four thousand seven hundred sixty and No/100 Dollars (\$124,760.00) (hereinafter called "amount of reimbursement"). If the City shall construct improvements or additions to the facilities described in Exhibit "A" with the approval of Metro after the date of this Agreement and prior to the takeover date, the City shall be reimbursed for the actual cost thereof in cash within thirty (30) days following the said takeover date in addition to the amount of reimbursement set forth above. The right of Metro to use facilities designated as "temporary" shall expire six months following the date of completion as determined by Metro of permanent metropolitan facilities adequate to replace such temporary facilities. The City shall continue to own the facilities described in this Section 9 and shall continue to pay the principal of and interest on any bonds issued to pay in whole or in part the cost of acquisition and construction of such facilities, provided that facilities which are designated as "permanent" shall be conveyed by the City to Metro by quit claim deed upon payment of all presently outstanding revenue bonds or general obligation bonds of the City secured by or issued to acquire or construct said facilities.

The City shall give written notice to Metro prior to April 1, 1961, setting forth the manner in which the amount of reimbursement shall be paid. The City may elect to receive all or any portion of said amount in cash within thirty (30) days following the date of delivery of revenue bonds issued by Metro for the purpose of providing funds therefor and, in any event, not later than July 1, 1962 (hereinafter called "cash payment date") and may elect to receive any portion which is not paid on said cash payment date together with interest thereon at the rate of 4% per annum from said date, in the form of a credit against the City's monthly sewage disposal charge in equal monthly amounts sufficient to amortize such unpaid amount of reimbursement and interest thereon prior to July 1, 1977. The City may at any time after the cash payment date elect to receive any unpaid portion of the amount of reimbursement in cash with interest at the rate of 4% per annum to date of final payment by giving written notice to Metro at least one year prior to the date such final payment is to be made.

Section 10. Insurance and Liability for Damages. Each Participant with a population of less than 100,000 shall secure and maintain with responsible insurers all such insurance as is customarily maintained with respect to sewerage systems of like character against loss of or damage to the respective sewerage facilities of each and against public and other liability to the extent that such insurance can be secured and maintained at reasonable cost. Any liability incurred by Metro as a result of the operation of the Metropolitan Sewerage System shall be the sole liability of Metro and any liability incurred by the City as a result of the operation of the Local Sewerage Facilities of the City shall be the sole liability of the City.

SECTION 11. Assignment. Neither of the parties hereto shall have the right to assign this Agreement or any of its rights and obligations hereunder nor to terminate its obligations hereunder by dissolution or otherwise without first securing the written consent of the other party and this Agreement shall be binding upon and inure to the benefit of the respective successors and assigns of the parties hereto. In the event that the City should be dissolved, the local sewer facilities owned and operated by the City shall be such act of dissolution be assigned and transferred to Metro subject to any outstanding debts of the City incurred for the construction or acquisition of such facilities and subject to the obligation of Metro to continue to provide sewer service to the residents served by such local facilities upon payment of the reasonable costs thereof.

Section 12. Effective Date and Term of Contract. This Agreement shall be in full force and effect and binding upon the parties hereto upon the execution of this Agreement and shall continue in full force and effect for a period of fifty years unless prior to the takeover date Metro shall not have entered into a firm commitment for the sale of revenue bonds to finance any portion of the comprehensive plan, then in such event only, this Agreement shall be terminated as of said date. Metro shall make every reasonable effort to secure such a commitment prior to said date.

Section 13. Notice. Whenever in this Agreement notice is required to be given, the same shall be given by registered mail addressed to the respective parties at the following addresses:

Municipality of Metropolitan Seattle
152 Penny Way
Seattle 9, Washington

City of Renton
Renton, Washington

unless a different address shall be hereafter designated in writing by either of the parties.

The date of giving such notice shall be deemed to be the date of mailing thereof. Billings for and payments of sewage disposal costs may be made by regular mail.

Section 14. Execution of Documents. This Agreement shall be executed in ten counterparts, any of which shall be regarded for all purposes as one original. Each party agrees that it will execute any and all deeds, instruments, documents and resolutions or ordinances necessary to give effect to the terms of this Agreement.

Section 15. Waiver. No waiver by either party of any term or condition of this Agreement shall be deemed or construed as a waiver of any other term or condition, nor shall a waiver of any breach be deemed to constitute a waiver of any subsequent breach whether of the same or a different provision of this Agreement.

Section 16. Remedies. In addition to the remedies provided by law, this Agreement shall be specifically enforceable by either party.

Section 17. Entirety. This Agreement merges and supersedes all prior negotiations, representations and agreements between the parties hereto relating to the subject matter hereof and constitutes the entire contract between the parties concerning the disposal of sewage by the City and acceptance of such sewage by Metro for disposal.

IN WITNESS WHEREOF, the parties hereto have executed this Agreement as of the day and year first above written.

CITY OF RENTON

By Isaac Piment
Mayor

ATTEST:

Helene Nelson
Helene Nelson
Acting City Clerk

MUNICIPALITY OF METROPOLITAN SEATTLE

By J. C. Carey Denworth
J. C. Carey Denworth
Chairman of the Council

ATTEST:

M. Marilyn Sullivan
Marilyn Sullivan
Clerk of the Council

STATE OF WASHINGTON

COUNTY OF KING

ss.

On this 1st day of May, 1961, before me personally appeared FRANK ALDING and HELMIE NELSON, to me known to be the Mayor and Acting City Clerk, respectively, of the City of Renton, a municipal corporation, and acknowledged the within and foregoing instrument to be the free and voluntary act and deed of said corporation, for the uses and purposes therein mentioned, and on oath stated that they were authorized to execute said instrument and that the seal affixed is the corporate seal of said corporation.

IN WITNESS WHEREOF, I have hereunto set my hand and affixed my official seal the day and year first above written.

Stanford Green
Notary Public in and for the State of
Washington, residing at Bellevue

STATE OF WASHINGTON

COUNTY OF KING

ss.

On this 2nd day of May, 1961, before me personally appeared C. GARRY DORNBORTH and MARALYN SULLIVAN, to me known to be the Chairman of the Council and Clerk of the Council, respectively, of the Municipality of Metropolitan Seattle, a municipal corporation, and acknowledged the within and foregoing instrument to be the free and voluntary act and deed of said corporation, for the uses and purposes therein mentioned, and on oath stated that they were authorized to execute said instrument and that the seal affixed is the corporate seal of said corporation.

IN WITNESS WHEREOF, I have hereunto set my hand and affixed my official seal the day and year first above written.

Arthur S. Shroy
Notary Public in and for the State of
Washington, residing at Seattle

EXHIBIT "A"

TEMPORARY FACILITIES

<u>FACILITY</u>	<u>FROM</u>	<u>TO</u>
Sewage Treatment Plant Outfall Sewer	Treatment Plant	Cedar River

Sewage Treatment Plant and associated improvements located on the following described property situated in King County, State of Washington, to wit:

Beginning at the intersection of the south margin of 6th Avenue North and the east margin of Commercial Waterway No. 2, in the City of Renton, Washington, as shown on the map prepared by Frank W. Harris, Engineer, for the Waterway Commissioners in February, 1928 and revised December, 1935; running thence south 13° 29' east along the east margin of Commercial Waterway No. 2, a distance of 328.75 feet; thence north 89° 45' 45" east parallel to and 320 feet distant from the south margin of 6th Avenue North, 366.34 feet; thence north 0° 14' 15" west and at right angles to the south margin of 6th Avenue North 320 feet to said south margin of 6th Avenue North; thence south 89° 45' 45" west along the south margin of 6th Avenue North 493.02 feet to the point of beginning.

EXHIBIT A (Continued)

The south half of the southwest quarter of the southwest quarter of Section 27, Township 26 North, Range 4 E.M.N., EXCEPT the east one-fourth and the west one-fourth thereof; and EXCEPT the east 30 feet thereof conveyed to King County for road purposes by deed recorded under Auditor's File No. 3347588.

FOOTNOTE: Comprehensive Plan Designation and Reference are as set forth in the "Metropolitan Seattle Sewerage and Drainage Survey" dated March 1958 and referred to in Section 1 of Resolution No. 23 of Metro.

Executed in 10 counterparts of
which this is counterpart No. 9

CAG 636-61

Ordinance 1879

AGREEMENT FOR SEWAGE DISPOSAL

THIS AGREEMENT made and executed this 2nd day
of May, 1961, between the CITY OF RENTON,
a municipal corporation of the State of Washington, herein-
after referred to as the "City" and the MUNICIPALITY OF
METROPOLITAN SEATTLE, a municipal corporation of the State
of Washington, hereinafter referred to as "Metro,"

W I T N E S S E T H:

WHEREAS, the public health, welfare and safety of
the residents of the City and the residents of the metro-
politan area require the elimination of existing sources of
water pollution and the preservation of the fresh and salt
water resources of the area; and

WHEREAS, growth of population, topographic con-
ditions and preservation of water resources require that
certain major sewage disposal works be constructed and
operated and that the cities and special districts within
the metropolitan area dispose of their sewage in accordance
with a comprehensive plan for the metropolitan area; and

WHEREAS, Metro was established by vote of the
people in the metropolitan area pursuant to Chapter 35.50
RCW for the purpose of performing the function of metropolitan
sewage disposal, has adopted a comprehensive plan for the
disposal of sewage from the metropolitan area and intends to
develop the facilities needed to carry out such plan and to
issue revenue bonds to finance such development; and

WHEREAS, to carry out the purposes of Metro and perform its authorized function and to provide for the disposal of sewage from the City into the metropolitan sewage disposal system it is necessary that a contract be now entered into establishing certain rights and duties of the parties incident thereto;

NOW, THEREFORE, in consideration of the mutual covenants contained herein, IT IS HEREBY AGREED as follows:

Section 1. Definition of Terms. The following words and phrases used in this contract shall have the meanings hereinafter set forth in this section:

- (a) The words "Comprehensive Plan" shall mean the Comprehensive Sewage Disposal Plan for the metropolitan area adopted in Resolution No. 23 of the Municipality of Metropolitan Seattle and as same may be hereafter amended from time to time in the manner required by law.
- (b) The words "Metropolitan Sewerage System" shall mean all of the facilities to be constructed, acquired or used by Metro as a part of the Comprehensive Plan. The Metropolitan Sewerage System shall generally include sewage disposal facilities with capacity to receive sewage from natural drainage areas of approximately one thousand acres or more. The Metropolitan Sewerage System shall thus include trunk or interceptor sewer facilities extending to a point within each tributary, and natural drainage area, where not more than one thousand acres remain to be served beyond the upper terminus of such trunk or interceptor sewer.

of the Metropolitan Sewerage System, including any additions and betterments thereto.

Section 4. Connection of Local Sewerage Facilities to the Metropolitan Sewerage System. Local Sewerage Facilities of the City shall be connected to the Metropolitan Sewerage System at such time as any portion of the Metropolitan Sewerage System shall be available to receive sewage collected by such facilities. Metro shall, at its sole expense, connect those Local Sewerage Facilities of the City which are now in existence or which shall be constructed in accordance with the rules and regulations of Metro prior to the availability of the Metropolitan Sewerage System. Local Sewerage Facilities constructed after the Metropolitan Sewerage System shall have been made available to the area served by such Local Sewerage Facilities shall be connected to the Metropolitan Sewerage System at the expense of the Participant in accordance with the rules and regulations of Metro.

Section 5. Payment for Sewage Disposal. For the disposal of sewage collected by the City and delivered to Metro, the City shall pay to Metro on or before the last day of each month during the term of this agreement, commencing with the month of July, 1962, a sewage disposal charge determined as provided in this Section 5.

1. For the quarterly periods ending March 31, June 30, September 30 and December 31 of each year every Participant shall submit a written report to Metro setting forth (a) the number of Residential Customers billed by such Participant for local sewerage charges as of the last day of the quarter, (b) the total number of all customers billed by such Participant as of such day and (c) the total water consumption during such

quarter for all customers billed by such Participant other than Residential Customers. The quarterly water consumption report shall be taken from water meter records and may be adjusted to exclude water which does not enter the sanitary facilities of a customer. Where actual sewage flow from an individual customer is metered, the metered sewage flows shall be reported in lieu of adjusted water consumption. The total quarterly water consumption report in cubic feet shall be divided by 2,700 to determine the number of Residential Customer equivalents represented by each Participant's customers other than single family residences. The first report shall cover the quarterly period ending December 31, 1960 and shall be submitted on or before March 1, 1961. Succeeding reports shall be made for each quarterly period thereafter and shall be submitted within thirty (30) days following the end of the quarter. Metro shall maintain a permanent record of the quarterly customer reports from each Participant.

2. To form a basis for determining the monthly sewage disposal charge to be paid by each Participant during any particular quarterly period Metro shall ascertain the number of Residential Customers and Residential Customer equivalents of each Participant for each such quarterly period beginning with the July-September quarter of the year 1962. This determination shall be made by taking the sum of the actual number of Residential Customers reported as of the last day of the next to the last preceding quarter and the average number of Residential Customer equivalents per quarter reported for the four quarters ending with said next to the last preceding quarter, adjusted to eliminate any Residential Customers or Residential Customer equivalents whose sewage is delivered to a governmental

agency other than Metro or other than a Participant for disposal outside of the Metropolitan Area.

3. For the period from July 1, 1962 to December 31, 1963, the monthly rate for each Residential Customer and Residential Customer equivalent of the City shall be Two dollars (\$2.00) and the monthly sewage disposal charge to be paid by each Participant to Metro shall be obtained by multiplying the number of Residential Customers and Residential Customer equivalents of the Participant as determined in subparagraph 2 of this section by the monthly rate of Two dollars.

4. For each calendar year after the year 1963, the monthly sewage disposal charge payable to Metro shall be determined as follows:

a) Prior to July 1st of each year Metro shall determine its total monetary requirements for the disposal of sewage during the next succeeding calendar year. Such requirements shall include the cost of administration, operation, maintenance, repair and replacement of the Metropolitan Sewerage System, establishment and maintenance of necessary working capital and reserves, the requirements of any resolution providing for the issuance of revenue bonds of Metro to finance the acquisition, construction or use of sewerage facilities, plus not to exceed 1% of the foregoing requirements for general administrative overhead costs.

b) To determine the monthly rate per Residential Customer or Residential Customer equivalent to be used during said next succeeding calendar year, the total monetary requirements for disposal of sewage as determined in subparagraph 4(a) of this section shall be divided by twelve and the resulting quotient shall be divided by the

total number of Residential Customers and Residential Customer equivalents of all Participants ascertained in accordance with subparagraph 2 of this section for the October-December quarter preceding said July 1st; provided, however, that the monthly rate shall not be less than Two Dollars (\$2.00) per month per Residential Customer or Residential Customer equivalent at any time during the period ending July 31, 1972.

c) The monthly sewage disposal charge paid by each Participant to Metro shall be obtained by multiplying the monthly rate by the number of Residential Customers and Residential Customer equivalents of the Participant determined as provided in Paragraph 2 of this section. An additional charge may be made for sewage or wastes of unusual quality or composition requiring special treatment, or Metro may require pretreatment of such sewage or wastes. An additional charge may be made for quantities of storm or ground waters entering those Local Sewerage Facilities which are constructed after January 1, 1961 in excess of the minimum standard established by the general rules and regulations of Metro.

5. A statement of the amount of the monthly sewage disposal charge shall be submitted by Metro to each Participant on or before the first day of each month during the term of this agreement commencing with the month of July 1962 and payment of such charge shall be due on the last day of such month. If any charge or portion thereof due to Metro shall remain unpaid for fifteen days following its due date, the Participant shall be charged with and pay to Metro interest on the amount unpaid from its due date until paid at the rate of 6% per annum, and Metro may, upon failure to pay such amount, enforce payment by any remedy available at law or equity.

6. The City irrevocably obligates and binds itself to pay its sewage disposal charge out of the gross revenues of the combined water and sewerage system of the City. The City further binds itself to establish, maintain and collect rates and charges for water and for sewage disposal service which will at all times be sufficient to pay all costs of maintenance and operation of the combined water and sewerage system of the City, including the sewage disposal charge payable to Metro hereunder, and sufficient to pay the principal of and interest on any revenue bonds of the City which shall constitute a charge upon such gross revenue. It is recognized by Metro and the City that the sewage disposal charge paid by the City to Metro shall constitute an expense of maintenance and operation of the combined water and sewerage system of the City. The City shall provide in the issuance of future water and sewer revenue bonds of the City that expenses of maintenance and operation of the combined water and sewerage system of the City shall be paid before payment of principal and interest of such bonds. It is further recognized that the City shall have the right to fix its own schedule of water and sewerage rates and charges, provided that same shall produce revenue sufficient to meet the covenants contained in this agreement.

Section 6. Responsibility of Participant. Each Participant shall be responsible for the delivery to the Metropolitan Sewerage System of sewage collected by such Participant, for the construction, maintenance and operation of Local Sewerage Facilities, and for the payment of all costs incident to the collection of such sewage and its delivery to the Metropolitan Sewerage System.

Section 7. Records. Permanent books and records shall be kept by Metro of the rates established, the volumes of sewage delivered and discharged into the Metropolitan Sewerage System wherever such volumes are measured and the number of Residential Customers and Residential Customer

equivalents reported by each Participant, in addition to complete books of account showing all costs incurred in connection with the Metropolitan Sewerage System. Such records shall be maintained beginning with the commencement of operation of any part of the Metropolitan Sewerage System.

Section 8. Development of Metropolitan Sewerage System. It is contemplated that the Metropolitan Sewerage System will be developed in stages and the nature of facilities to be constructed, acquired or used and the time of such construction, acquisition or use shall be determined by Metro, it being contemplated that Metro shall ultimately provide sewage disposal service for the entire Metropolitan Area.

Section 9. Use of Facilities Owned or Operated by the City. Effective July 1, 1962, or such earlier date as may be mutually agreed upon (hereinafter called "takeover date"), Metro shall have the exclusive right to use and the duty to maintain, operate, repair and replace the facilities owned by the City which are described in Exhibit "A" attached hereto and by this reference made a part hereof, subject to the continued availability of such facilities to receive, transport or treat sewage delivered by the City. From and after the takeover date Metro shall acquire, construct, maintain, operate, repair and replace all facilities now or hereafter required for the treatment and disposal of sewage delivered by the City and the City shall make payment for such treatment and disposal as provided in Section 5 of this Agreement.

For the privilege of using the facilities described in Exhibit "A" Metro shall pay to the City the total amount of One hundred twenty-four thousand seven hundred sixty and No/100 Dollars (\$124,760.00) (hereinafter called "amount of reimbursement"). If the City shall construct improvements or additions to the

facilities described in Exhibit "A" with the approval of Metro after the date of this Agreement and prior to the takeover date, the City shall be reimbursed for the actual cost thereof in cash within thirty (30) days following the said takeover date in addition to the amount of reimbursement set forth above. The right of Metro to use facilities designated as "temporary" shall expire six months following the date of completion as determined by Metro of permanent metropolitan facilities adequate to replace such temporary facilities. The City shall continue to own the facilities described in this Section 9 and shall continue to pay the principal of and interest on any bonds issued to pay in whole or in part the cost of acquisition and construction of such facilities, provided that facilities which are designated as "permanent" shall be conveyed by the City to Metro by quit claim deed upon payment of all presently outstanding revenue bonds or general obligation bonds of the City secured by or issued to acquire or construct said facilities.

The City shall give written notice to Metro prior to June 1, 1961, setting forth the manner in which the amount of reimbursement shall be paid. The City may elect to receive all or any portion of said amount in cash within thirty (30) days following the date of delivery of revenue bonds issued by Metro for the purpose of providing funds therefor and, in any event, not later than July 1, 1962 (hereinafter called "cash payment date") and may elect to receive any portion which is not paid on said cash payment date together with interest thereon at the rate of 4% per annum from said date, in the form of a credit against the City's monthly sewage disposal charge in equal monthly amounts sufficient to amortize such unpaid amount of reimbursement and interest thereon prior

to July 1, 1977. The City may at any time after the cash payment date elect to receive any unpaid portion of the amount of reimbursement in cash with interest at the rate of 4% per annum to date of final payment by giving written notice to Metro at least one year prior to the date such final payment is to be made.

Section 10. Insurance and Liability for Damages.

Each Participant with a population of less than 100,000 shall secure and maintain with responsible insurers all such insurance as is customarily maintained with respect to sewerage systems of like character against loss of or damage to the respective sewerage facilities of each and against public and other liability to the extent that such insurance can be secured and maintained at reasonable cost. Any liability incurred by Metro as a result of the operation of the Metropolitan Sewerage System shall be the sole liability of Metro and any liability incurred by the City as a result of the operation of the Local Sewerage Facilities of the City shall be the sole liability of the City.

Section 11. Assignment. Neither of the parties

hereto shall have the right to assign this Agreement or any of its rights and obligations hereunder nor to terminate its obligations hereunder by dissolution or otherwise without first securing the written consent of the other party and this Agreement shall be binding upon and inure to the benefit of the respective successors and assigns of the parties hereto. In the event that the City should be dissolved, the local sewer facilities owned and operated by the City shall by such act of dissolution be assigned and transferred to Metro subject to any outstanding debts of the City incurred for the construction

or acquisition of such facilities and subject to the obligation of Metro to continue to provide sewer service to the residents served by such local facilities upon payment of the reasonable costs thereof.

Section 12. Effective Date and Term of Contract.

This Agreement shall be in full force and effect and binding upon the parties hereto upon the execution of the Agreement and shall continue in full force and effect for a period of fifty years unless prior to the takeover date Metro shall not have entered into a firm commitment for the sale of revenue bonds to finance any portion of the Comprehensive Plan, then in such event only, this Agreement shall be terminated as of said date. Metro shall make every reasonable effort to secure such a commitment prior to said date.

Section 13. Notice. Whenever in this Agreement notice is required to be given, the same shall be given by Registered Mail addressed to the respective parties at the following addresses:

Municipality of Metropolitan Seattle
152 Denny Way
Seattle 9, Washington

City of Renton
Renton, Washington

unless a different address shall be hereafter designated in

writing by either of the parties.

The date of giving such notice shall be deemed to be the date of mailing thereof. Billings for and payments of sewage disposal costs may be made by regular mail.

Section 14. Execution of Documents. This Agreement shall be executed in ten counterparts, any of which shall be regarded for all purposes as one original. Each party agrees that it will execute any and all deeds, instruments, documents and resolutions or ordinances necessary to give effect to the terms of this Agreement.

Section 15. Waiver. No waiver by either party of any term or condition of this Agreement shall be deemed or construed as a waiver of any other term or condition, nor shall a waiver of any breach be deemed to constitute a waiver of any subsequent breach whether of the same or a different provision of this Agreement.

Section 16. Remedies. In addition to the remedies provided by law, this Agreement shall be specifically enforceable by either party.

Section 17. Entirety. This Agreement merges and supersedes all prior negotiations, representations and agreements between the parties hereto relating to the subject matter hereof and constitutes the entire contract between the parties concerning the disposal of sewage by the City and acceptance of such sewage by Metro for disposal.

IN WITNESS WHEREOF, the parties hereto have executed

this Agreement as of the day and year first above written.

CITY OF RENTON

By

Frank Allment
Frank Allment
Mayor

ATTEST:

Helen Nelson
Helen Nelson
Acting City Clerk

MUNICIPALITY OF METROPOLITAN SEATTLE

By

C. Carey Donworth
C. Carey Donworth
Chairman of the Council

ATTEST:

Marilyn Sullivan
Marilyn Sullivan
Clerk of the Council

EXHIBIT "A"

TEMPORARY FACILITIES

FACILITY

FROM

TO

Sewage Treatment Plant
Outfall Sewer

Treatment Plant

Cedar River

Sewage Treatment Plant and associated improvements located on the following described property situated in King County, State of Washington, to wit:

Beginning at the intersection of the south margin of 6th Avenue North and the east margin of Commercial Waterway No. 2, in the City of Renton, Washington, as shown on the map prepared by Frank W. Harris, Engineer, for the Waterway Commissioners in February, 1928 and revised December, 1935; running thence south 13° 29' east along the east margin of Commercial Waterway No. 2, a distance of 328.75 feet; thence north 89° 45' 45" east parallel to and 320 feet distant from the south margin of 6th Avenue North, 366.34 feet; thence north 0° 14' 15" west and at right angles to the south margin of 6th Avenue North 320 feet to said south margin of 6th Avenue North; thence south 89° 45' 45" west along the south margin of 6th Avenue North 493.02 feet to the point of beginning.

CITY OF RENTON
MUNICIPALITY OF METROPOLITAN SEATTLE
AMENDMENT TO AGREEMENT
FOR SEWAGE DISPOSAL

THIS AMENDMENT made as of the _____ day
of _____ between the City of
Renton, a municipal corporation of the State of Washington
(hereinafter referred to as the "City") and the Municipality
of Metropolitan Seattle, a metropolitan municipal
corporation of the State of Washington (hereinafter referred
to as "Metro");

WITNESSETH:

WHEREAS, the parties have entered into a long term
Agreement for Sewage Disposal dated May 2, 1961, as amended
(hereinafter referred to as the "Basic Agreement"); and

WHEREAS, an advisory committee composed of elected
and appointed officials in the metropolitan area was
appointed by the Metropolitan Council to examine the
structure of Metro's charges to its participants; and

WHEREAS, said advisory committee, following
extensive research, study and deliberations, has recommended
certain changes in the structure of Metro's charges to its
participants and implementation of said changes requires
amendment of the Basic Agreement; and

WHEREAS, the parties have determined that the
recommendations are in the best public interest and
therefore desire to amend said Basic Agreement to implement
said recommendations;

AND, THEREFORE, it is hereby amended as follows:

Section 3. Amendment of Section 5 of the Basic Agreement. Section 5 of the Basic Agreement is hereby amended to read as follows:

"Section 5. Payment for Sewage Disposal. For the disposal of sewage hereafter collected by the City and delivered to Metro the City shall pay to Metro on or before the last day of each month during the term of this Agreement, a sewage disposal charge determined as provided in this Section 5.

1. For the quarterly periods ending March 31, June 30, September 30 and December 31 of each year every Participant shall submit a written report to Metro setting forth:

(a) the number of Residential Customers billed by such Participant for local sewerage charges as of the last day of the quarter,

(b) the total number of all customers billed for local sewerage charges by such Participant as of such day, and

(c) the total water consumption during such quarter for all customers billed for local sewerage charges by such Participant other than Residential Customers.

The quarterly water consumption report shall be taken from water meter records and may be adjusted to exclude water which does not enter the sanitary facilities of the customer. Where actual sewage flow from an individual customer is metered, the metered sewage flows shall be reported in lieu of adjusted water consumption. The total quarterly water consumption report in cubic feet shall be divided by 2,350 to determine the number of Residential Customer equivalents represented by each Participant's customers other than single family residences.

Metro shall maintain a permanent record of the quarterly customer reports from each Participant.

The City's first quarterly report shall cover the first quarterly period following the date when sewage is first delivered to Metro and shall be submitted within thirty days following the end of the quarter. Succeeding reports shall be made for each quarterly period thereafter and shall be submitted within thirty (30) days following the end of the quarter.

2. (a) To form a basis for determining the monthly sewage disposal charge to be paid by each Participant during any particular quarterly period, Metro shall ascertain the number of Residential Customers and Residential Customer equivalents of each Participant. This determination shall be made by taking the sum of the actual number of Residential customers reported as of the last day of the next to the last preceding quarter and the average number of Residential Customer Equivalents per quarter reported for the four quarters ending with said next to the last preceding quarter, adjusted for each Participant to eliminate any Residential Customers or Residential Customer equivalents whose sewage is delivered to a governmental agency other than Metro or other than a Participant for disposal outside of the Metropolitan Area.

(b) For the initial period until the City shall have submitted six consecutive quarterly reports, the reported number of Residential Customers and Residential Customer equivalents of the City shall be determined as provided in this subparagraph (b). On or before the tenth day of each month beginning with the month prior to the month in which sewage from the City is first delivered to Metro, the City shall submit a written statement of the number of Residential Customers and Residential Customer equivalents estimated to be billed by the City during the

next succeeding month. For the purpose of determining the basic reported number of Residential Customers and Residential Customer equivalents of the City for such next succeeding month, Metro may at its discretion adopt either such estimate or the actual number of Residential Customers and Residential Customer equivalents reported by the City as of the last day of the next to the last preceding reported quarter. After the City shall have furnished six consecutive quarterly reports the reported number of Residential Customers and Residential Customer equivalents of the City shall be determined as provided in the immediately preceding subparagraph (a).

(c) If the City shall fail to submit the required monthly and/or quarterly reports when due, Metro may make its own estimate of the number of Residential Customers and Residential Customer equivalents of the City and such estimate shall constitute the reported number for the purpose of determining sewage disposal charges.

3. The monthly sewage disposal charge payable to Metro shall be determined as follows:

(a) Prior to July 1st of each year Metro shall determine its total monetary requirements for the disposal of sewage during the next succeeding calendar year. Such requirements shall include the cost of administration, operation, maintenance, repair and replacement of the Metropolitan Sewerage System, establishment and maintenance of necessary working capital and reserves, the requirements of any resolution providing for the issuance of revenue bonds of Metro to finance the acquisition, construction or use of sewerage facilities, plus not to exceed 1% of the foregoing requirements for general administrative overhead costs.

(b) To determine the monthly rate per Residential Customer or Residential Customer equivalent to be used

during the next succeeding calendar year, the total monetary requirements for disposal of sewage as determined in subparagraph 3(a) of this section shall be divided by twelve and the resulting quotient shall be divided by the total number of Residential Customers and Residential Customer equivalents of all Participants for the October-December quarter preceding said July 1st; provided, however, that the monthly rate shall not be less than Two Dollars (\$2.00) per month per Residential Customer or Residential Customer equivalent at any time during the period ending July 31, 1972.

(c) The monthly sewage disposal charge paid by each Participant to Metro shall be obtained by multiplying the monthly rate by the number of Residential Customers and Residential Customer equivalents of the Participant. An additional charge may be made for sewage or wastes of unusual quality or composition requiring special treatment, or Metro may require pretreatment of such sewage or wastes.

4. The parties acknowledge that, by resolution of the Metropolitan Council, Metro may impose a charge or charges directly on the future customers of a Participant for purposes of paying for capacity in Metropolitan Sewage Facilities and that such charges shall not constitute a breach of this agreement or any part thereof. The proceeds of said charge or charges, if imposed, shall be used only for capital expenditures or defeasance of outstanding revenue bonds prior to maturity.

In the event such a charge or charges are imposed, the City shall, at Metro's request, provide such information regarding new residential customers and residential customer equivalents as may be reasonable and appropriate for purposes of implementing such a charge or charges.

5. A statement of the amount of the monthly sewage disposal charge shall be submitted by Metro to each

Participant on or before the first day of each month and payment of such charge shall be due on the last day of such month. If any charge or portion thereof due to Metro shall remain unpaid for fifteen days following its due date, the Participant shall be charged with and pay to Metro interest on the amount unpaid from its due date until paid at the rate of 6% per annum, and Metro may, upon failure to pay such amount, enforce payment by any remedy available at law or equity.

6. The City irrevocably obligates and binds itself to pay its sewage disposal charge out of the gross revenues of the sewer system of the City. The City further binds itself to establish, maintain and collect charges for sewer service which will at all times be sufficient to pay all costs of maintenance and operation of the sewer system of the City, including the sewage disposal charge payable to Metro hereunder and sufficient to pay the principal of and interest on any revenue bonds of the City which shall constitute a charge upon such gross revenues. It is recognized by Metro and the City that the sewage disposal charge paid by the City to Metro shall constitute an expense of the maintenance and operation of the sewer system of the City. The City shall provide in the issuance of future sewer revenue bonds of the City that expenses of maintenance and operations of the sewer system of the City shall be paid before payment of principal and interest of such bonds. The City shall have the right to fix its own schedule of rates and charges for sewer service provided that same shall produce revenue sufficient to meet the covenants contained in this Agreement.

Section 3. Amendment of Section 6 of the Basic Agreement. Section 6 of the Basic Agreement is hereby amended to read as follows:

Section 8. Responsibility of the City. The City shall be responsible for the delivery to the Metropolitan Sewerage System of sewage collected by the City, for construction, maintenance and operation of Local Sewerage Facilities, and for the payment of all costs incident to the collection of such sewage and its delivery to the Metropolitan Sewerage System.

In addition, the City will undertake continual rehabilitation and replacement of its local sewage facilities for purposes of preventing, reducing and eliminating the entry of extraneous water into such facilities and will expend annually, averaged over five (5) years, an amount equal to two (2) cents per inch of diameter per foot of its local sewage facilities, excluding combined sewers and force mains, for said rehabilitation and replacement. The amount of this expenditure requirement may be increased from time to time by the Metropolitan Council to reflect general inflation. Rehabilitation and replacement projects undertaken pursuant to this section shall be constructed in accordance with criteria adopted by the Metropolitan Council and included in Metro's Rules and Regulations. In the event the City fails to comply with the rehabilitation and replacement expenditure requirements described in this section, the City shall pay such charge as may be determined by Metro for quantities of storm or ground water entering its Local Sewerage Facilities in excess of the minimum standard established by the general Rules and Regulations of Metro.

Section 9. Amendment of Basic Agreement to Add a New Section. A new Section 18 shall be added to the Basic Agreement to read as follows:

"Section 18. Future Amendments. The City agrees to amend and hereby concurs in any amendment to this agreement which incorporates any changes in the terms for

sewerage disposal and/or payment therefor as may be proposed by Metro and agreed to by those Participants that shall represent, in total, not less than 90% of the Residential Customers and Residential Customer Equivalents then served by the Metropolitan Sewerage System."

Section 4. Effective Date of Amendment. This amendment shall take effect at the beginning of the first quarter following the date first written above with quarters beginning January 1, April 1, July 1, and October 1.

Section 5. Basic Agreement Unchanged. Except as otherwise provided in this amendment, all provisions of the basic agreement shall remain in full force and effect as written therein.

IN WITNESS WHEREOF, the parties have executed this Agreement as of the day and year first written above.

CITY OF SEASIDE

ATTEST:

MUNICIPALITY OF
METROPOLITAN SEATTLE

Gary Zimmerman
Chair of the Council

ATTEST:

Executed in 2 counterparts
which this is counterpart No. 1

CAG. 1685-70
(Amendment to
CAG. 636-61
(Ord. 1879))
CAG 636-61
Addn. #1-70

MUNICIPALITY OF METROPOLITAN SEATTLE -
CITY OF RENTON

1st SUPPLEMENTAL AGREEMENT
(JOINT USE OF SOUTH RENTON TRUNK)

THIS AGREEMENT made and executed as of this 18th day of June, 1970, between the CITY OF RENTON, a municipal corporation of the State of Washington, (hereinafter referred to as the "City"), and the MUNICIPALITY OF METROPOLITAN SEATTLE, a municipal corporation of the State of Washington, (hereinafter referred to as "Metro");

WITNESSETH:

WHEREAS, the parties have heretofore entered into a long-term agreement for Sewage Disposal dated May 2, 1961, (hereinafter referred to as the "Basic Agreement"); and

WHEREAS, the parties desire to amend certain portions of the Basic Agreement to reflect changed conditions and policies; and

WHEREAS, Metro has constructed portions of the South Renton Trunk Sewer (hereinafter referred to as the "Trunk Sewer"), to serve as both a facility of the Metropolitan Sewerage System and a Local Sewerage Facility; and

WHEREAS, the City desires to use portions of the South Renton Trunk Sewer as a Local Sewerage Facility;

NOW, THEREFORE, in consideration of the mutual covenants contained herein, it is hereby agreed as follows:

Section 1. Definition of Terms. The defined terms used in this contract shall have the meanings set forth in the Basic Agreement. Where manhole numbers are referred to, reference is

made to Metro Contract Document 68-11 for the South Renton Trunk Sewer, copies of which are on file with Metro and the City.

Section 2. Amendment of Basic Agreement - Delivery and Acceptance of Sewage. Section 2 of the Basic Agreement is hereby amended to read as follows:

"Section 2. Delivery and Acceptance of Sewage. The City shall deliver to Metro all of the sewage and industrial waste collected by the City and Metro shall accept the sewage and waste delivered for treatment and disposal as hereinafter provided subject to such reasonable rules and regulations as may be adopted from time to time by the Metropolitan Council. Metro shall not directly accept sewage or waste from any person, firm or private corporation which is located within the boundaries of or is delivering its sewage into the Local Sewerage Facility of the City without the written consent of the City."

Section 3. Joint Use of South Renton Trunk Sewer. The City and Metro agree that the Trunk Sewer between Manhole R18-19 and Manhole R18-22 shall serve as both a Metropolitan and a Local Sewerage Facility. Local connections may be made on the north side of said Trunk Sewer in order to serve property northerly of said Trunk Sewer included in the City's Local Improvement District 264 in a manner as shall be approved by Metro. For the right to make such direct local connections, the City shall pay to Metro within thirty (30) days following the date of this agreement the sum of \$6,232.37. Said amount represents one-half the cost of constructing an eight-inch (8") local sewer on the same alignment as the Trunk Sewer.

The City and Metro further agree that additional direct local connections may be made to other sections of the Trunk Sewer or to the south side of the Trunk Sewer between Manhole R18-19 and Manhole R18-22, in such a manner as approved by Metro. For the right to make these additional local connections the City shall pay to Metro the sum of \$11.28 per front foot of property served on each side of the Trunk Sewer alignment (\$22.56 per front foot of property served if service is given on both sides). Said amounts represent the estimated cost of providing sewer service by constructing an eight-inch (8") local sewer on the same alignment as the Trunk Sewer. The City shall submit to Metro for approval, a plot plan indicating the amount of frontage and property to be served and shall make payment to Metro of the agreed upon amount before each such additional local connection is made.

The City shall either construct, operate and maintain, at its expense, or cause others to construct, operate and maintain at their expense, any side sewers or Local Sewerage Facilities connected to said Trunk Sewer up to and including the tee connection. Metro shall have no responsibility for either construction, operation or maintenance of such side sewers or Local Sewerage Facilities, but shall operate and maintain at its sole expense all portions of the Trunk Sewer.

Section 4. Amendment of Basic Agreement - Termination.

Section 12 of the Basic Agreement is hereby amended to read as follows:

"Section 12. Effective Date and Term of Contract. This Agreement shall be in full force and effect and binding upon the parties hereto upon the execution of the Agreement

and shall continue in full force and effect until July 1, 2016."

Section 5. Amendment of Basic Agreement - Payment for Sewage Disposal. Section 5 of the Basic Agreement is hereby amended to read:

"Section 5. Payment for Sewage Disposal. For the disposal of sewage hereafter collected by the City and delivered to Metro the City shall pay to Metro on or before the last day of each month during the term of this Agreement, a sewage disposal charge determined as provided in this Section 5.

1. For the quarterly periods ending March 31, June 30, September 30 and December 31 of each year every Participant shall submit a written report to Metro setting forth (a) the number of Residential Customers billed by such Participant for local sewerage charges as of the last day of the quarter, (b) the total number of all customers billed by such Participant as of such day and (c) the total water consumption during such quarter for all customers billed by such Participant other than Residential Customers. The quarterly water consumption report shall be taken from water meter records and may be adjusted to exclude water which does not enter the sanitary facilities of a customer. Where actual sewage flow from an individual customer is metered, the metered sewage flows shall be reported in lieu of adjusted water consumption. The total quarterly water consumption report in cubic feet shall be divided by 2,700 to determine the number of Residential Customer equivalents

represented by each Participant's customers other than single family residences. Metro shall maintain a permanent record of the quarterly customer reports from each Participant.

The City's reports shall be made for each quarterly period and shall be submitted within thirty (30) days following the end of the quarter. For so long as the City shall serve any customers located outside of the Metropolitan Area the City shall separately report the number of Residential Customers and Residential Customer equivalents located within the Metropolitan Area and the number thereof located outside the Metropolitan Area.

2. a) To form a basis for determining the monthly sewage disposal charge to be paid by each Participant during any particular quarterly period, Metro shall ascertain the number of Residential Customers and Residential Customer equivalents of each Participant. This determination shall be made by taking the sum of the actual number of Residential Customers reported as of the last day of the next to the last preceding quarter and the average number of Residential Customer equivalents per quarter reported for the four quarters ending with said next to the last preceding quarter, adjusted for each Participant to eliminate any Residential Customers or Residential Customer equivalents whose sewage is delivered to a governmental agency other than Metro or other than a Participant for disposal outside of the Metropolitan Area. The number thus determined is hereinafter called the "basic reported number."

b) If the City shall fail to submit the required monthly and/or quarterly reports when due, Metro may make its own estimate of the number of Residential Customers and Residential Customer equivalents of the City and such estimate shall constitute the basic reported number for the purpose of determining sewage disposal charges.

c) The basic reported number of Residential Customers and Residential Customer equivalents of the City shall be further adjusted by adding thereto twenty-five percent (25%) of the number of Residential Customers or Residential Customer equivalents of the City located outside the Metropolitan Area. The sum thus determined is hereinafter called the "adjusted reported number". If any territory served by the City which is located outside the Metropolitan Area shall be annexed to Metro at any time after the date of this Agreement or if the twenty-five percent additive adjustment shall have been paid by the City for a period of ten years, said additive adjustment shall be eliminated effective as of the first day of the month following such annexation or upon the tenth anniversary of the date when such additive adjustment shall have first been paid to Metro by the City. The adjusted reported number of Residential Customers and Residential Customer equivalents of the City shall be the number of Residential Customers and Residential Customer equivalents reported by the City for the purpose of determining sewage disposal charges pursuant to Paragraph 3 of this section.

3. The monthly sewage disposal charge payable to Metro shall be determined as follows:

a) Prior to July 1st of each year Metro shall determine its total monetary requirements for the disposal of sewage during the next succeeding calendar year. Such requirements shall include the cost of administration, operation, maintenance, repair and replacement of the Metropolitan Sewerage System, establishment and maintenance of necessary working capital and reserves, the requirements of any resolution providing for the issuance of revenue bonds of Metro to finance the acquisition, construction or use of sewerage facilities, plus not to exceed 1% of the foregoing requirements for general administrative overhead costs.

b) To determine the monthly rate per Residential Customer or Residential Customer equivalent to be used during said next succeeding calendar year, the total monetary requirements for disposal of sewage as determined in subparagraph 3(a) of this section shall be divided by twelve and the resulting quotient shall be divided by the total number of Residential Customers and Residential Customer equivalents of all Participants for the October-December quarter preceding said July 1st; provided, however, that the monthly rate shall not be less than Two Dollars (\$2.00) per month per Residential Customer or Residential Customer equivalent at any time during the period ending July 31, 1972.

c) The monthly sewage disposal charge paid by each Participant to Metro shall be obtained by multiplying the monthly rate by the number of Residential Customers.

and Residential Customer equivalents of the Participant. An additional charge may be made for sewage or wastes of unusual quality or composition requiring special treatment, or Metro may require pretreatment of such sewage or wastes. An additional charge may be made for quantities of storm or ground waters entering those Local Sewerage Facilities which are constructed after January 1, 1961, in excess of the minimum standard established by the general rules and regulations of Metro.

4. A statement of the amount of the monthly sewage disposal charge shall be submitted by Metro to each Participant on or before the first day of each month and payment of such charge shall be due on the last day of such month. If any charge or portion thereof due to Metro shall remain unpaid for fifteen days following its due date, the Participant shall be charged with and pay to Metro interest on the amount unpaid from its due date until paid at the rate of 6% per annum, and Metro may, upon failure to pay such amount, enforce payment by any remedy available at law or equity.

5. The City irrevocably obligates and binds itself to pay its sewage disposal charge out of the gross revenues of the sewer system of the City. The City further binds itself to establish, maintain and collect charges for sewer service which will at all times be sufficient to pay all costs of maintenance and operation of the sewer system of the City, including the sewage disposal charge payable to Metro hereunder

and sufficient to pay the principal of and interest on any revenue bonds of the City which shall constitute a charge upon such gross revenues. It is recognized by Metro and the City that the sewage disposal charge paid by the City to Metro shall constitute an expense of maintenance and operation of the sewer system of the City. The City shall provide in the issuance of future sewer revenue bonds of the City that expenses of maintenance and operation of the sewer system of the City shall be paid before payment of principal and interest of such bonds. The City shall have the right to fix its own schedule of rates and charges for sewer service provided that same shall produce revenue sufficient to meet the covenants contained in this Agreement and provided that the customers of the City located within the Metropolitan Area shall be separately classified from those located outside the Metropolitan Area for rate making purposes and the rates for sewer service to customers located within the Metropolitan Area shall fully reflect any lower Metro sewage disposal charge for sewage from customers within the Metropolitan Area."

Section 6. Basic Agreement Otherwise Unchanged. Except as otherwise provided in this Agreement, all provisions of the Basic Agreement shall remain in full force and effect as written therein.

IN WITNESS WHEREOF, the parties have executed this Agreement as of the day and year first above written.

CITY OF RENTON

Avery Garrett
Avery Garrett
Mayor

ATTEST:



Harold Johnson
Harold Johnson
Clerk

MUNICIPALITY OF METROPOLITAN SEATTLE

C. Carey Donworth
C. Carey Donworth
Chairman of the Council



Mary Ann Sullivan
Mary Ann Sullivan
Clerk of the Council

STATE OF WASHINGTON)
) ss.
COUNTY OF KING)

On this 3rd day of June, 1970, before me personally appeared AVERY GARRETT and HELMIE NELSON, to me known to be the Mayor and City Clerk, respectively, of the City of Renton, a municipal corporation, and acknowledged the within and foregoing instrument to be the free and voluntary act and deed of said corporation, for the uses and purposes therein mentioned, and on oath stated that they were authorized to execute said instrument and that the seal affixed is the corporate seal of said corporation.



IN WITNESS WHEREOF, I have hereunto set my hand and affixed my official seal the day and year first above written.

Harold S. Yessett
Notary Public in and for the State
of Washington, residing at Renton

STATE OF WASHINGTON)
) ss.
COUNTY OF KING)

On this 18th day of June, 1970, before me personally appeared C. CAREY DONWORTH and MARALYN SULLIVAN, to me known to be the Chairman of the Council and the Clerk of the Council, respectively, of the Municipality of Metropolitan Seattle, a municipal corporation, and acknowledged the within and foregoing instrument to be the free and voluntary act and deed of said corporation, for the uses and purposes therein mentioned, and on oath stated that they were authorized to execute said instrument and that the seal affixed is the corporate seal of said corporation.



IN WITNESS WHEREOF, I have hereunto set my hand and affixed my official seal the day and year first above written.

FS 5 14 FS

Jack O. Hildebrand
Notary Public in and for the State
of Washington, residing at Seattle

Filed for Record June 25 1970 2:23 PM
Request of Metro
N. B.

CITY OF RENTON
MUNICIPALITY OF METROPOLITAN SEATTLE

EXTENSION OF AGREEMENT FOR SEWAGE DISPOSAL

WHEREAS, the City of Renton (the "City") and the Municipality of Metropolitan Seattle (the "Municipality") are parties to a certain Agreement for Sewage Disposal (the "Agreement") dated May 2, 1961, as amended, pursuant to which the City delivers to the Municipality for treatment and disposal all the sewage and industrial wastes it collects from its service area; and

WHEREAS, the Agreement expires by its terms on July 1, 2016; and

WHEREAS, it is in the best interests of the City and the Municipality that the expiration date of the Agreement be extended in order to allow the Municipality to sell and issue its sewer revenue bonds with maturities extending beyond 2016;

NOW, THEREFORE, in consideration of the mutual covenants contained herein and in the Agreement, it is hereby agreed as follows:

The Agreement for Sewage Disposal between the City of Renton and the Municipality of Metropolitan Seattle dated May 2, 1961, as amended, is hereby extended for a period of twenty years and shall continue in full force and effect until July 1, 2036.

It is further agreed that all other provisions of said Agreement shall remain unchanged, and the Agreement dated May 2, 1961, as amended, as extended herein shall constitute the entire Agreement for Sewage Disposal between the parties.

DATED: This ~~20th~~^{19th} day of ~~January~~^{March}, 1987

CITY OF RENTON

By Nancy Mathews
Nancy Mathews, Mayor Pro Tem

ATTEST:

Maureen E. Moter
City Clerk

MUNICIPALITY OF METROPOLITAN
SEATTLE

By Gary Zimmerman
Gary Zimmerman
Chairman of the Council

ATTEST:

Bonnie Mattson
Bonnie Mattson
Clerk of the Council

CITY OF RENTON
MUNICIPALITY OF METROPOLITAN SEATTLE
AMENDMENT TO AGREEMENT
FOR SEWAGE DISPOSAL

THIS AMENDMENT made as of the 2nd day
of October, 1992 between the City of
Renton, a municipal corporation of the State of Washington
(hereinafter referred to as the "City") and the Municipality
of Metropolitan Seattle, a metropolitan municipal
corporation of the State of Washington (hereinafter referred
to as "Metro");

WITNESSETH:

WHEREAS, the parties have entered into a long term
Agreement for Sewage Disposal dated May 2, 1961, as amended
(hereinafter referred to as the "Basic Agreement"); and

WHEREAS, an advisory committee composed of elected
and appointed officials in the metropolitan area was
appointed by the Metropolitan Council to examine the
structure of Metro's charges to its participants; and

WHEREAS, said advisory committee, following
extensive research, study and deliberations, has recommended
certain changes in the structure of Metro's charges to its
participants and implementation of said changes requires
amendment of the Basic Agreement; and

WHEREAS, the parties have determined that the
recommendations are in the best public interest and
therefore desire to amend said Basic Agreement to implement
said recommendations;

NOW, THEREFORE, it is hereby agreed as follows:

Section 1. Amendment of Section 5 of the Basic Agreement. Section 5 of the Basic Agreement is hereby amended to read as follows:

"Section 5. Payment for Sewage Disposal. For the disposal of sewage hereafter collected by the City and delivered to Metro the City shall pay to Metro on or before the last day of each month during the term of this Agreement, a sewage disposal charge determined as provided in this Section 5.

1. For the quarterly periods ending March 31, June 30, September 30 and December 31 of each year every Participant shall submit a written report to Metro setting forth:

(a) the number of Residential Customers billed by such Participant for local sewerage charges as of the last day of the quarter,

(b) the total number of all customers billed for local sewerage charges by such Participant as of such day, and

(c) the total water consumption during such quarter for all customers billed for local sewerage charges by such Participant other than Residential Customers.

The quarterly water consumption report shall be taken from water meter records and may be adjusted to exclude water which does not enter the sanitary facilities of the customer. Where actual sewage flow from an individual customer is metered, the metered sewage flows shall be reported in lieu of adjusted water consumption. The total quarterly water consumption report in cubic feet shall be divided by 2,250 to determine the number of Residential Customer equivalents represented by each Participant's customers other than single family residences. Metro shall maintain a permanent record of the quarterly customer reports from each Participant.

The City's first quarterly report shall cover the first quarterly period following the date when sewage is first delivered to Metro and shall be submitted within thirty days following the end of the quarter. Succeeding reports shall be made for each quarterly period thereafter and shall be submitted within thirty (30) days following the end of the quarter.

2. (a) To form a basis for determining the monthly sewage disposal charge to be paid by each Participant during any particular quarterly period, Metro shall ascertain the number of Residential Customers and Residential Customer equivalents of each Participant. This determination shall be made by taking the sum of the actual number of Residential customers reported as of the last day of the next to the last preceding quarter and the average number of Residential Customer Equivalents per quarter reported for the four quarters ending with said next to the last preceding quarter, adjusted for each Participant to eliminate any Residential Customers or Residential Customer equivalents whose sewage is delivered to a governmental agency other than Metro or other than a Participant for disposal outside of the Metropolitan Area.

(b) For the initial period until the City shall have submitted six consecutive quarterly reports, the reported number of Residential Customers and Residential Customer equivalents of the City shall be determined as provided in this subparagraph (b). On or before the tenth day of each month beginning with the month prior to the month in which sewage from the City is first delivered to Metro, the City shall submit a written statement of the number of Residential Customers and Residential Customer equivalents estimated to be billed by the City during the next succeeding month. For the purpose of determining the basic reported number of Residential Customers and

Residential Customer equivalents of the City for such next succeeding month, Metro may at its discretion adopt either such estimate or the actual number of Residential Customers and Residential Customer equivalents reported by the City as of the last day of the next to the last preceding reported quarter. After the City shall have furnished six consecutive quarterly reports the reported number of Residential Customers and Residential Customer equivalents of the City shall be determined as provided in the immediately preceding subparagraph (a).

(c) If the City shall fail to submit the required monthly and/or quarterly reports when due, Metro may make its own estimate of the number of Residential Customers and Residential Customer equivalents of the City and such estimate shall constitute the reported number for the purpose of determining sewage disposal charges.

3. The monthly sewage disposal charge payable to Metro shall be determined as follows:

(a) Prior to July 1st of each year Metro shall determine its total monetary requirements for the disposal of sewage during the next succeeding calendar year. Such requirements shall include the cost of administration, operation, maintenance, repair and replacement of the Metropolitan Sewerage System, establishment and maintenance of necessary working capital and reserves, the requirements of any resolution providing for the issuance of revenue bonds of Metro to finance the acquisition, construction or use of sewerage facilities, plus not to exceed 1% of the foregoing requirements for general administrative overhead costs.

(b) To determine the monthly rate per Residential Customer or Residential Customer equivalent to be used during said next succeeding calendar year, the total monetary requirements for disposal of sewage as determined

7

in subparagraph 3(a) of this section shall be divided by twelve and the resulting quotient shall be divided by the total number of Residential Customers and Residential Customer equivalents of all Participants for the October-December quarter preceding said July 1st; provided, however, that the monthly rate shall not be less than Two Dollars (\$2.00) per month per Residential Customer or Residential Customer equivalent at any time during the period ending July 31, 1972.

(c) The monthly sewage disposal charge paid by each Participant to Metro shall be obtained by multiplying the monthly rate by the number of Residential Customers and Residential Customer equivalents of the Participant. An additional charge may be made for sewage or wastes of unusual quality or composition requiring special treatment, or Metro may require pretreatment of such sewage or wastes. An additional charge may be made for quantities of storm or ground waters entering those Local Sewerage Facilities which are constructed after January 1, 1961 in excess of the minimum standard established by the general rules and regulations of Metro.

4. The parties acknowledge that, by resolution of the Metropolitan Council, Metro may impose a charge or charges directly on the future customers of a Participant for purposes of paying for capacity in Metropolitan Sewerage Facilities and that such charges shall not constitute a breach of this agreement or any part thereof. The proceeds of said charge or charges, if imposed, shall be used only for capital expenditures or defeasance of outstanding revenue bonds prior to maturity.

In the event such a charge or charges are imposed, the City shall, at Metro's request, provide such information regarding new residential customers and residential customer

equivalents as may be reasonable and appropriate for purposes of implementing such a charge or charges.

5. A statement of the amount of the monthly sewage disposal charge shall be submitted by Metro to each Participant on or before the first day of each month and payment of such charge shall be due on the last day of such month. If any charge or portion thereof due to Metro shall remain unpaid for fifteen days following its due date, the Participant shall be charged with and pay to Metro interest on the amount unpaid from its due date until paid at the rate of 6% per annum, and Metro may, upon failure to pay such amount, enforce payment by any remedy available at law or equity.

6. The City irrevocably obligates and binds itself to pay its sewage disposal charge out of the gross revenues of the sewer system of the City. The City further binds itself to establish, maintain and collect charges for sewer service which will at all times be sufficient to pay all costs of maintenance and operation of the sewer system of the City, including the sewage disposal charge payable to Metro hereunder and sufficient to pay the principal of and interest on any revenue bonds of the City which shall constitute a charge upon such gross revenues. It is recognized by Metro and the City that the sewage disposal charge paid by the City to Metro shall constitute an expense of the maintenance and operation of the sewer system of the City. The City shall provide in the issuance of future sewer revenue bonds of the City that expenses of maintenance and operations of the sewer system of the City shall be paid before payment of principal and interest of such bonds. The City shall have the right to fix its own schedule of rates and charges for sewer service provided that same shall produce revenue sufficient to meet the covenants contained in this Agreement.

Section 2. Effective Date of Amendment. This amendment shall take effect at the beginning of the first quarter following the date first written above with quarters beginning January 1, April 1, July 1, and October 1.

Section 3. Basic Agreement Unchanged. Except as otherwise provided in this amendment, all provisions of the basic agreement shall remain in full force and effect as written therein.

IN WITNESS WHEREOF, the parties have executed this Agreement as of the day and year first written above.

CITY OF RENTON

Carl DeGuer

ATTEST:

Marilyn Peterson
City Clerk

MUNICIPALITY OF METROPOLITAN SEATTLE

Gary Stinson

Chair of the Council

ATTEST:

Danni Nelson

MAY 19 1991

APPROVED

**UTILITIES COMMITTEE
COMMITTEE REPORT**

June 4, 1990

**PROPOSED AMENDMENTS TO METRO SEWAGE DISPOSAL AGREEMENT
(Referred 3/19/90)**

Amendments proposed to the Metro-City of Renton Agreement for Sewage Disposal would reduce the residential customer equivalency from 900 cubic feet per month to 750 cubic feet per month and would allow Metro to charge a connection fee to future customers to cover a portion of system capital costs.

The Utilities Committee, upon reviewing these proposed amendments, recommends concurrence with the Public Works Department's recommendation to approve the amended Sewage Disposal Agreement.

The Committee further recommends that this action be sent to the Ways and Means Committee for preparation of a Resolution authorizing the Mayor and City Clerk to execute the contract amendment on behalf of the City of Renton.

Tom Nelson
Tom Nelson, Chair

Kathy Keolker-Wheeler
Kathy Keolker-Wheeler, Vice Chair

Jesse Tanner
Jesse Tanner, Member

UCRMETRO/BJAW

Copies: Ryan Sedemann
Dick Anderson

CITY OF RENTON

KING COUNTY

AMENDMENT TO AGREEMENT FOR SEWAGE DISPOSAL

AGREEMENT REGARDING ODOR AND CHEMICAL USE AT SOUTH PLANT

THIS AGREEMENT made as of the 14th day of June, 200~~3~~⁴ between the City of Renton, a municipal corporation of the State of Washington (hereinafter referred to as "the City") and King County, a political subdivision of the State of Washington (hereinafter referred to as "the County");

WITNESSETH:

WHEREAS, the city and the county have entered into a long term agreement for sewage disposal dated May 2, 1961 as amended (hereinafter referred to as the "Basic Agreement") and the county has proposed certain changes to, and extension of, the Basic Agreement; and

WHEREAS, the city concurs that said proposed changes and extension are in the best interest of the parties and the citizens of the Metropolitan Area; and

WHEREAS, the county operates a wastewater treatment plant in the city (hereinafter referred to as "South Plant") and desires to operate said plant in a manner that minimizes any negative impacts of said operation on the citizens and businesses of the city and the surrounding area; and

WHEREAS, the city and the county desire that odors from plant operations be prevented and controlled and that risks associated with the use of certain chemicals at the plant be obviated ; and

WHEREAS, by Ordinance No.14712, adopted July 14, 2003, the King County Council has established specific policies related to the control of odor at county wastewater facilities; and

WHEREAS, the county has discontinued its use of chlorine for disinfection of wastewater at South Plant and is currently using sodium hypochlorite applied through temporary feed systems and plans to construct a permanent feed system for said use;

NOW, THEREFORE, IT IS HEREBY AGREED AS FOLLOWS:

Section 1. Amendment of Basic Agreement. Section 5. of the Basic Agreement is hereby amended by adding the following new subsection 3.d)

“d) An additional charge may be made to recover unforeseen costs to operate and maintain the metropolitan sewerage system or meet debt requirements if the county executive declares and the council by a majority vote finds that the system cannot be adequately maintained, and debt policies met, without such additional charge. The additional charge shall then be effective no earlier than the first day of the second month following the emergency declaration described in this subparagraph 3.d) and shall be billed and collected in the same manner as the monthly rate referenced in subparagraph 3.c). The additional charge described in this paragraph 3.d) may be incorporated into the next rate setting cycle but will otherwise terminate within twelve months of the date approved. The additional charge described in this subparagraph 3.d) shall not be made until and unless it conforms to the sewage disposal agreements with all remaining participants.”

Section 2. Amendment of the Basic Agreement—New Section. A new Section 18 is added to the Basic Agreement as follows:

“Section 18. Future Amendments. The city agrees to amend and hereby concurs in any amendment to this agreement which incorporates any changes in the terms for sewage disposal and payment therefor as may be proposed by the county and agreed to by those participants that shall represent, in total, not less than 90% of the residential customers and residential customer equivalents then served by the Metropolitan Sewerage System.”

Section 3. Extension of Basic Agreement. The Agreement for Sewage Disposal between the City of Renton and King County dated May 2, 1961, as amended, is hereby extended for a period of twenty years and shall continue in full force and effect until July 1, 2056. The agreement dated May 2, 1961, as subsequently amended and extended shall constitute the entire agreement for Sewage Disposal between the parties.

Section 4. Conversion to Sodium Hypochlorite. The county will complete its modifications to the chemical building at South Plant to create permanent primary and secondary feed systems for use of sodium hypochlorite for the disinfection of wastewater. The county will make every reasonable effort to complete said modifications by March 31, 2007 and will continue using non-chlorine disinfectants applied through temporary feed systems until that time.

Section 5. Implementation of Odor Control Improvements. The county will construct or otherwise implement all Phase 1 odor prevention improvements identified for South Plant in the *Odor Prevention Policy Recommendations* dated March 18, 2003 and by this reference made part of this agreement. The county will make every reasonable effort to implement said improvements, specifically identified as "imperative" on Table A.1 of said *Odor Prevention Policy Recommendations*, no later than December 31, 2006. The covering of the aeration basins, one of the improvements identified as "imperative" on Table A.1, will be accomplished as far in advance of that date as is practicable.

The county will evaluate the effectiveness of Phase I improvements following their implementation. If the odor prevention goals described in Ordinance No. 14712 have not been achieved the county will implement Phase II improvements as soon as is practicable and in no event later than 2008. The attached schedule for improvements within Phase I and Phase II, Table A.2 of the *Odor Prevention Policy Recommendations*, is attached to this agreement to indicate priority projects and estimated timing for each project. The county may, at its option, substitute equally effective measures in the event such measures are identified during

preliminary design of the measures identified on said Table A.1. If Phase II improvements are required to be installed, their effectiveness shall be evaluated in 2009. If Phase II improvements fail to meet the goals of the policies the County will implement Phase III level improvements in coordination with the City. During implementation of all phases of odor control work, the County shall employ "best in country for existing facilities" standards as defined in *the Odor Prevention Policy Recommendations*. As new technology becomes available to the County in implementing the odor control measures, an evaluation shall be made to determine its suitability for South Plant.

IN WITNESS WHEREOF, the parties have executed this agreement as of the day and year first written above.

City of Renton

By Jesse Jenner
Jesse Jenner
Title Mayor
12-4-2003

Attest:

Bonnie I. Walton
Bonnie I. Walton, City Clerk

King County

By Pam Bessometh
Pam Bessometh
Title Director, Dept. of
Natural Resources and Parks

Attest:

[Signature]

Table A.2: South Plant Odor Prevention Improvement Recommendations - Timelines & Costs by Task

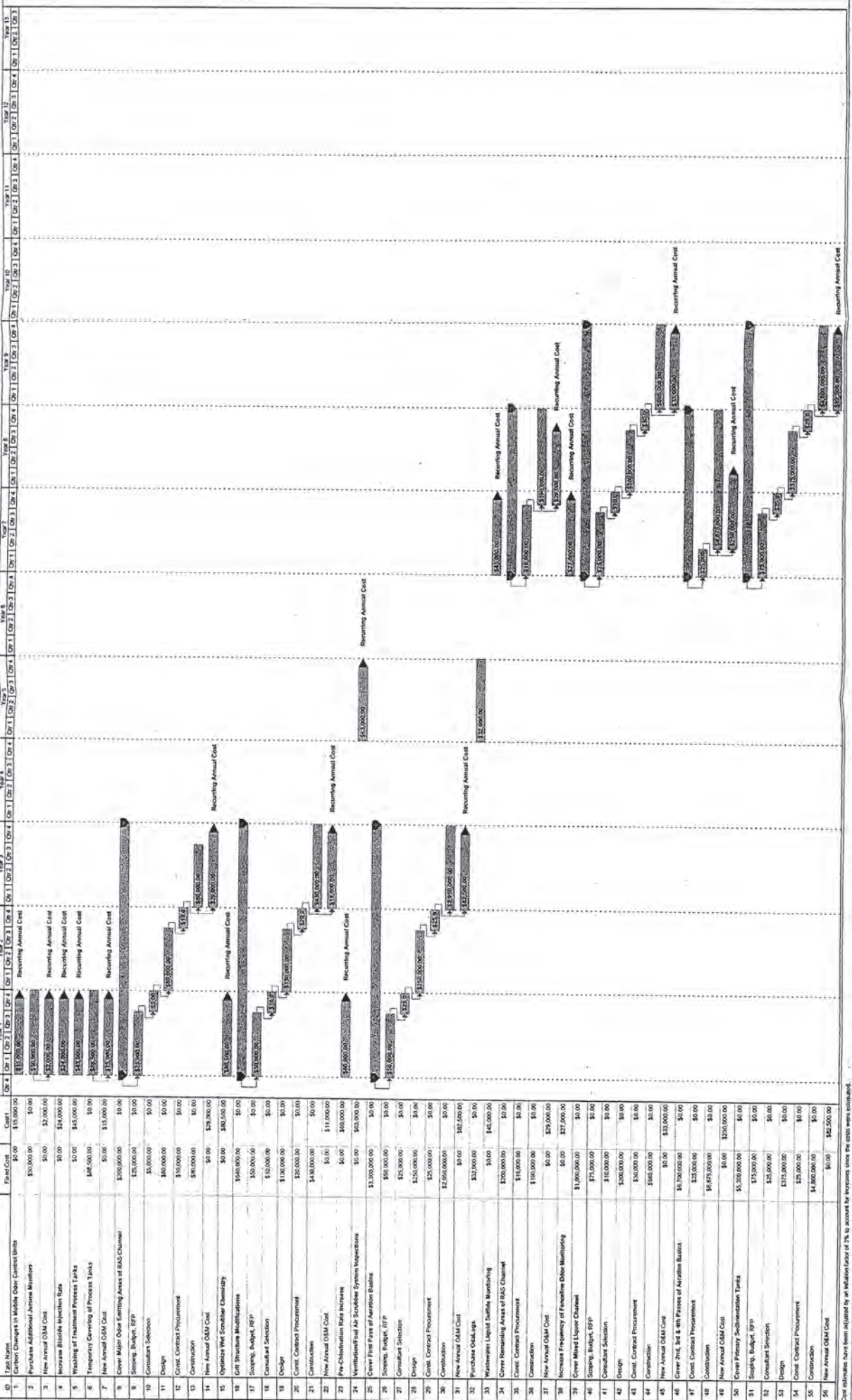

Cost estimates have been adjusted by an inflation factor of 1% to account for expenses since the costs were initially set.

**2008 ADDENDUM TO
CITY OF RENTON & SOOS CREEK WATER AND SEWER DISTRICT
AGREEMENT FOR THE TRANSFER OF FACILITIES
AND FOR
THE ESTABLISHMENT OF SERVICE BOUNDARIES**

THIS ADDENDUM, made and entered into this 18th day of July, 2008, by and between the CITY OF RENTON, a Washington municipal corporation, hereinafter referred to as "the City", and SOOS CREEK WATER AND SEWER DISTRICT, a Washington municipal corporation, hereinafter referred to as "the District", both being duly organized and existing under and by virtue of the laws of the State of Washington,

WITNESSETH:

WHEREAS, with effective date of the 6th day of August, 1991, the City and the District entered into the following agreement:

CITY OF RENTON & SOOS CREEK WATER AND SEWER DISTRICT
AGREEMENT FOR THE TRANSFER OF FACILITIES
AND FOR
THE ESTABLISHMENT OF SERVICE BOUNDARIES

(1991 AGREEMENT); and

WHEREAS, by mutual agreement, the Agreement has been modified from time to time as to the boundaries of the City and District service areas to reflect service issues regarding the timing of various developments by the City and the District; and

WHEREAS, the parties now desire to again modify the AGREEMENT as to service area; and

WHEREAS, the 1991 AGREEMENT, as modified by this Addendum, will continue to provide for maximum efficient use of existing and future facilities, and the orderly and efficient water and sanitary sewer system planning.

NOW, THEREFORE:

IT IS HEREBY AGREED by and between the parties hereto as follows:

1. **Service Area Boundaries.** The parties have agreed that in consideration of the mutual agreements contained herein, the service area boundaries between the City and the District shall be modified as shown in Exhibit A hereto, which is incorporated herein by this reference.

2. **Amended Terms for Service by District.** The parties agree that the District may install a mainline sewer line in South 28th Street, which may serve into the City's sewer collection system.

3. **Amended Terms of Payment by District.** In consideration of the foregoing, the District will pay 50% of the collected General Facility Charges collected for the lots that connect to a mainline sewer line to be installed in South 28th Street to the City; such lots are identified in Exhibit B hereto, which is incorporated herein by this reference.

3. **Remaining Obligations Intact.** Nothing herein shall be construed to alter the rights, responsibilities, liabilities, or obligations of either the City or the District pursuant to either the 1991 AGREEMENT, or any amendments thereto, except as specifically set forth herein.

Approved by Resolution No. 3957 of the City Council of the CITY OF RENTON, Washington, at its regular meeting held on the 14th day of July, 2008.

CITY OF RENTON

By: _____

Denis Law

Title: _____

Denis Law, Mayor

Attest: _____

Bonnie I. Walton

City Clerk - Bonnie I. Walton

Approved by Motion of the Board of Commissioners of **SOOS CREEK WATER AND SEWER DISTRICT** of King County, Washington, at its regular meeting held on the 5 day of MAY, 2008.

SOOS CREEK WATER AND SEWER DISTRICT

By: 

Ron Speer, District Manager

EXHIBIT "A"



EXHIBIT "B"

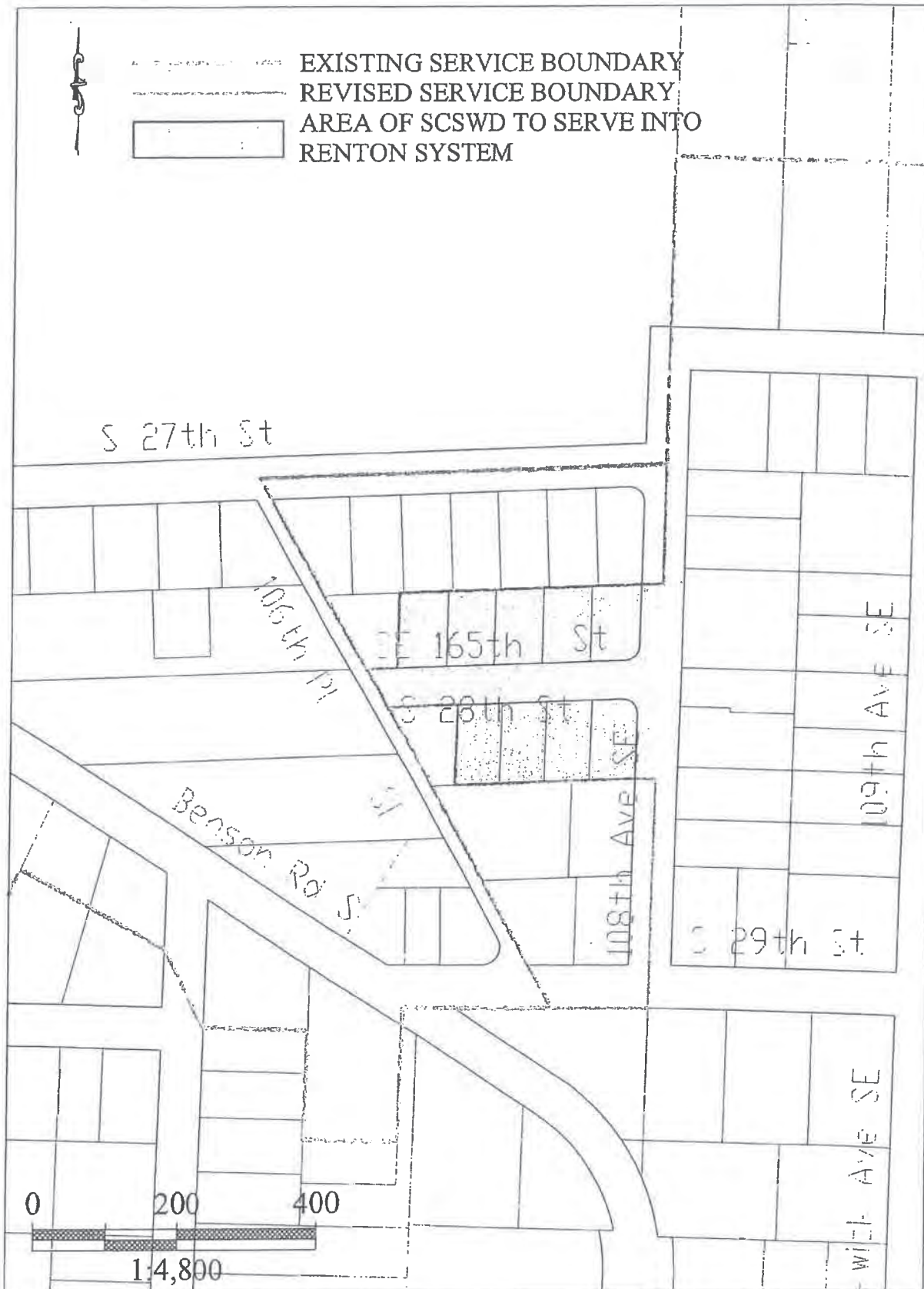

Appendix F
STANTEC MODEL UPDATE AND CAPACITY
ANALYSIS REPORT



City of Renton
2015 Hydraulic Model Update

SUMMARY REPORT

December 2015

Prepared By

Stantec
11130 NE 33rd Place, Suite 200
Bellevue, WA 98004
(425) 869-9448



Handwritten signature of Erik Brodahl in blue ink.

Erik Brodahl, PE



Handwritten signature of Brian Wolf in blue ink.

Brian Wolf, PE

TABLE OF CONTENTS

	<u>Page No.</u>
Chapter 1 INTRODUCTION	1.1
PROJECT UNDERSTANDING	1.1
MODELING SOFTWARE	1.2
Chapter 2 PHYSICAL MODEL UPDATE	2.1
2012 PHYSICAL MODEL DEVELOPMENT	2.1
Data Source	2.1
Manholes and Nodes	2.1
Pipes	2.1
Lift Stations and Force Mains.....	2.1
Extent of 2012 Hydraulic Model	2.3
Model Pipe and Manhole ID Updates.....	2.3
ULTIMATE PHYSICAL MODEL DEVELOPMENT.....	2.4
Pipe, Manhole and Node Additions	2.4
Chapter 3 PLANNING DATA	3.1
MODEL SANITARY FLOW DETERMINATION	3.1
Dry Weather Flow Determination by Mini-Basin	3.1
Diurnal Curve Development	3.1
MODEL PLANNING DATA.....	3.1
Planning Area/Basin Boundaries	3.2
<i>2012 Model</i>	3.2
<i>Ultimate Model</i>	3.2
Land Use and Zoning	3.5
Data Projections	3.5
<i>Residential</i>	3.5
<i>Employment</i>	3.7
<i>Schools</i>	3.7
Future Population Projections	3.7
<i>Residential</i>	3.7
<i>Employment</i>	3.8
<i>Schools</i>	3.9
POPULATION AND SANITARY SEWAGE FLOW ASSIGNMENT TO MODEL	3.10
Population Assignment.....	3.10
Determination of Sanitary Sewer Flow Rates.....	3.11

Table of Contents

Input to Model 3.15
 Area Assignments 3.15
RAINFALL AND EVAPORATION ASSIGNMENTS..... 3.16
 Rainfall Assignments..... 3.16
 Evaporation..... 3.16
 External Boundary Flows..... 3.16
Chapter 4 MODEL CALIBRATION **4.1**
2012 MODEL DRY WEATHER CALIBRATION 4.2
 Sanitary Flow Calibration 4.2
2012 MODEL WET WEATHER CALIBRATION 4.6
 Infiltration and Inflow Calibration 4.6
 Non-Calibrated Model Basins 4.8
 Ultimate Model Inflow and Infiltration Parameters 4.9
Chapter 5 ANALYSIS AND RESULTS **5.1**
2012 MODEL PEAK FLOW AND CAPACITY ANALYSIS 5.1
 External Boundary Flows..... 5.1
 Peak Storm..... 5.1
 Analysis Results 5.3
ULTIMATE MODEL PEAK FLOW AND CAPACITY ANALYSIS 5.17
 Peak Storm..... 5.17
 Analysis Results 5.17
LIFT STATION AND FORCE MAIN ANALYSIS 5.33
INFILTRATION AND INFLOW ANALYSIS..... 5.34
PEAK BOUNDARY FLOW ANALYSIS 5.37
Chapter 6 RECOMMENDATIONS AND SUMMARY **6.1**
FLOW MONITORING RECOMMENDATIONS 6.1
KING COUNTY COMPATIBILITY 6.3
LIMITATIONS OF THE MODEL 6.6

TABLES

Table 2-1 Pipe Material Summary 2.4
Table 3-1 Population Projections by Sewer Mini-Basins: Values Assigned to 2012 and
Ultimate Models 3.12
Table 4-1 Dry Weather Calibration Summary 4.4
Table 4-2 Per Capita Flow Rate (ft²/PE/day) 4.5
Table 4-3 Wet Weather Calibration Summary..... 4.8

Table of Contents

Table 4-4 City Mini-Basins Not Calibrated for Dry and Wet Weather 4.9

Table 5-1 Selected Storm Events Per Model Basin 5.3

Table 5-2 Capacity Analysis for 2012 Sewer Model - Problem Areas 5.5

Table 5-3 City of Renton Sewer Model 2012 and Ultimate Peak Flow at Mini-Basin Outlet,
Including Storm Event 5.18

Table 5-4 Capacity Analysis for Ultimate Sewer Model - Problem Areas 5.21

Table 5-5 Lift Station and Force Main Analysis Summary 5.33

Table 5-6 Peak Infiltration and Inflow per Mini-Basin 5.35

Table 5-7 Peak Boundary Flows 5.37

Table 6-1 City of Renton Sewer Model Proposed Flow Monitor Locations 6.2

FIGURES

Figure 3.1 2012 Sewer Mini-Basin Boundaries 3.3

Figure 3.2 Ultimate Sewer Mini-Basin Boundaries 3.4

Figure 5.1 Selected Storm Events Per Model-Basin 5.2

Figure 5.2 2012 Sewer Model Analysis Results 5.38

Figure 5.3 Ultimate Sewer Model Analysis Results 5.39

Figure 6.1 Proposed Flow Monitor Locations 6.8

APPENDIX

APPENDIX A – Dry Weather Flow Calibration Time Series A

APPENDIX B – Wet Weather Flow Calibration Time Series B

APPENDIX C – Figure 5-2A Through Figure 5-2S: 2012 Sewer Model Analysis Results C

APPENDIX D – Figure 5-3A Through Figure 5-3W: Ultimate Sewer Model Analysis Results D

PROJECT UNDERSTANDING

The City of Renton retained the services of Stantec to update the existing hydraulic model to evaluate the capacity of the existing sewer system and to analyze the system for future development scenarios. Steps in the development of the sewer model included:

1. Updates of the physical model that involved obtaining, formatting, and inputting into the physical system data such as manholes, pipes and lift stations.
2. Obtaining and analyzing the population and employment data to input as flow assignments to each sewer basin with the precipitation and evaporation data.
3. Calibration of the model to 2012 conditions.
4. Analyzing the 2012 and Ultimate Model Peak Flow Scenarios.

The methodology and numerous assumptions associated with developing the model are detailed herein, with supporting documents associated with the project. The report includes the following sections:

- Chapter 1 – Introduction
- Chapter 2 – Physical Model Updates
- Chapter 3 – Planning Data
- Chapter 4 – Model Calibration
- Chapter 5 – Analysis and Results
- Chapter 6 – Recommendations and Summary

Two primary models were used during this project. The 2012 Model was updated from previous versions of the model, and was calibrated to King County's 2008-2011 flow-monitoring data. Discussion of the original model development can be found in the City of Renton Sanitary Sewer Model Development and Analysis Summary Report, September 2006. The Ultimate Model was then developed, which incorporates all of the projected flow assignments for the analysis.

MODELING SOFTWARE

The model was analyzed using the MIKE URBAN software program by the Danish Hydraulic Institute (DHI), and was originally developed using MOUSE, also by DHI. DHI assisted King County with the 2001 regional Infiltration and Inflow (I&I) study, and King County also used MOUSE for the 2012 I/I study, and has assisted the City and Stantec with the development of the original MOUSE model, conversion of the MOUSE model to MIKE URBAN, and development of the City's sewer system geodatabase.

CHAPTER 2 PHYSICAL MODEL UPDATE

The development of the two primary models (2012 and Ultimate) is summarized below.

2012 PHYSICAL MODEL DEVELOPMENT

Data Source

The basis for the MIKE URBAN model update was primarily the City's GIS database, and includes system data from 2008 through March 2012. Additional data was provided from topographic survey data and sewer record drawings. To be consistent with the previous model development and updates, the following rules were applied when adding new facilities to the model:

Manholes and Nodes

- Cleanouts and connected piping were generally excluded from the model.
- The correct manhole diameters were assigned to the model where available. Manholes were generally assumed to be 4-foot diameter if no other information was available.
- Outlet loss for manholes in the model was assumed to be "round-edged." To remain conservative yet more realistic, the outlet loss was assigned as "round-edged" to the manholes, and the default loss value "Km" was reduced from 0.25 to 0.1.
- At a few locations, the new sewer information was joined the older portions of the model. Interpolations and/or datum shifts of elevations were necessary during the original model development. In many of these cases, it was necessary to re-interpolate or re-work the existing manhole elevations to match the new data.

Pipes

- Specific pipe lengths were generally not input into the model; instead the pipe lengths were scaled based on the coordinates from the City's GIS.

Lift Stations and Force Mains

- Best available pumping rate data was used to input flow rates for single pumps in duplex stations. Pumps were assumed to operate at a constant rate (the design flow rate) throughout the ranges of operation. The pump

data originated from pumping tests and flow monitoring data supplied by the City. Pump curves were not used for the lift stations in the model. Generally, the magnitude of flow rates from the lift stations relative to the larger system flows were considered to be small enough to neglect the effects of wet well fluctuations for modeling purposes.

- The pump controls (on/off) are based on actual level settings obtained from the City. The second pump in each station is activated based on the wet well level, and a very rough estimate was made for the flow rates with both pumps running. For the backup pumps within lift stations, where no other information was available, the second pump was assumed to produce approximately 1/4 to 1/3 of the flow rate of the first pump when the pumps operate simultaneously. It is recognized that per DOH requirements for duplex stations, a single pump must be sized to handle the entire peak flow of the design storm event. The flow rate from the second pump is defined as the difference between the first pump operating alone, and the combined pumping rate (e.g., Pump 1 pumps 1.0 cfs throughout operation range, Pump 2 pumps 0.25 cfs throughout its operating range).
- The alignment, size, and material of force mains is physically defined in the model. However, intermittent grade changes along the alignment are not represented.
- Appropriate lift stations were added and abandoned in the model for the different scenarios and timeframes analyzed, as described below, and in the sections discussing the Ultimate Models.

The following lift stations were added or modified in the 2012 Model:

- Denny's Lift Station (L07) Improvements
- Airport Lift Station (L25) Replacement
- Stonegate Lift Station (L27) Replacement
- Shy Creek Lift Station (L01)
- Liberty Lift Station (L34)

The following lift stations, which have been removed from service, were removed in the 2012 Model:

- Summer Wind Lift Station
- Earlington Lift Station
- East Renton Lift Station
- High Gate Lift Station

- Highland Estates Lift Station
- Evendell Lift Station

A few of the improvements described above, including the Liberty Lift Station and Airport Lift Station Improvements, were not active until after 2012. These improvements were added after the calibration was complete.

Extent of 2012 Hydraulic Model

The majority of the City's sewer system as it existed in 2012 was incorporated into the hydraulic model. Clean-outs, dead-end portions of the system with missing/errant information, and some portions of private system were not included.

Although present in the physical model, a portion of the City's system south of Mini-Basin 5 did not include flow assignments, per direction from City staff (this portion of the system is "dry" piping in the model), since it is tributary to another purveyor's Mini-Basin (SOO039). This area is located in the South portion of the City, primarily serving customers on South 55th Street (between 99th Place South and SR-167) and on Talbot Road South (between South 50th Street and South 194th Street).

Isolated areas where small portions of the City's piping are tributary to sewer purveyors other than King County were generally not modeled.

Model Pipe and Manhole ID Updates

The City updated its geodatabase in 2014. Included in this update was a revision to the naming conventions for the sewer infrastructure, including manholes, cleanouts, gravity pipes, force mains, and lift stations. In order to more easily identify and discuss the analysis of the sewer system, the City requested that we update the City sewer identifiers (MUIDs) within the model to be consistent with the geodatabase. This included updates to the pipe material identifications, which were adjusted to conform to NASSCO standards for pipe inspection.

With the assistance of DHI, Stantec imported and updated the MUIDs and pipe materials. Small isolated areas of the City sewer system were not updated. These locations were typically updates to the geodatabase that occurred after 2012, or were locations where the model included horizontal and vertical bends in the pipe not adequately represented in the GIS. The King County interceptor sewer pipes were not updated during this procedure. Table 2-1 lists the pipe materials and associated Manning's roughness values.

**Table 2-1
Pipe Material Summary**

Pipe Material	Manning's Roughness
Legacy MOUSE model material descriptions	
Concrete (Smooth)	0.013
Plastic	0.011
NASSCO Material Descriptions	
CAS - Cast Iron	0.0143
CP - Concrete Pipe (non-reinforced)	0.0133
DIP - Ductile Iron Pipe	0.012
PE - Polyethylene	0.011
PSC - Plastic/Steel Composite	0.011
PVC - Polyvinyl Chloride	0.011
VCP - Vitrified Clay Pipe	0.014
XXX - Not Known	0.0143

A small number of pipes and manholes from sewer improvements after 2012 were added to the model in order successfully complete the ID updates.

ULTIMATE PHYSICAL MODEL DEVELOPMENT

Pipe, Manhole and Node Additions

The 2012 Model was used as the base to create the Ultimate physical model. Development of the Ultimate Model included working with City Staff to determine and include future system improvements, such as:

- The proposed diversion sewer for Heather Downs/Maplewood Heights was added. The proposed sewer will begin south of the Union Avenue SE/SE 4th Street Intersection and will drain sewage flows down a steep slope, and connect to the existing sewer located in the Maplewood Golf Course.
- The proposed Talbot Hills Sewer relocation was added. This involves relocation of the sewer from South 14th Street and redirection of the sewer to flow by gravity to Smithers Avenue S. This also includes installation of a new sewer crossing under I-405 at the extension of Smithers Avenue S to S Renton Village Place.

- The proposed Thunder Hills diversion sewer, located on S 18th Street between Grant Avenue S and Eagle Ridge Drive S, was added. The downstream sewers between Eagle Ridge Drive and Smithers Avenue S were upsized to accommodate increased flow rates.

In addition to the improvements listed above, “dummy” nodes were added to represent portions of the “U” Basins or other existing sub-basins not currently served by sewer. To represent future service, nodes were added for each mini-basin or sub-basin, generally a single node each for residential, employment, and any school populations.

CHAPTER 3 PLANNING DATA

The planning data section includes the populations and areas assigned to each mini-basin, the assumptions used to model sanitary sewer flow, peak flow generating storm events assigned to each model basin, and I&I assignments.

MODEL SANITARY FLOW DETERMINATION

Unlike the flow monitoring performed for the original 2001 Infiltration and Inflow study performed by King County, the decennial flow monitoring used for the 2012 study did not include each of the City's mini-basins. Instead, flow monitors were placed at fewer locations. Typically, the locations were at the outlet of each Model Basin, although a small number of mini-basins were also assigned a flow monitor. There were 25 flow monitors placed which recorded flows generated within the City's sewer service area.

Dry Weather Flow Determination by Mini-Basin

Dry weather flow data from the 2009-2010 flow monitoring season was generally used to determine total average sanitary sewage flows for each mini-basin. King County staff identified the periods meeting their criteria for dry weather flow. For model basins receiving flow from upstream tributary basins, time series using the flow monitoring data were developed and added to the model as boundary conditions to examine the total flow through the basin.

Diurnal Curve Development

The diurnal curves developed during the creation of the 2001 Mouse model were not modified for the 2012 or Ultimate models.

MODEL PLANNING DATA

Population projections were compiled for the City of Renton Sewer Service Area for current and future conditions. The populations are divided into four categories; single-family residential, multi-family residential, employment, and schools.

Most of the projections for the three categories (not including schools) were taken from the Puget Sound Regional Council (PSRC) Land Use Baseline projections, which were developed using the UrbanSims model, and cut to the City of Renton sewer mini-basin boundaries by PSRC staff. Due to confidentiality requirements established by the Employment Securities Department, employment populations could not be provided for six sewer mini-basin boundaries. Because of this, two different methods, which are described later in the chapter, were used to estimate

the employment populations for current and future conditions. A small number of residential populations were also modified after our review of the PSRC data.

School populations were derived from enrollment data published by the school districts located within the City sewer service area.

Planning Area/Basin Boundaries

2012 Model

Population and employment data was assigned to the hydraulic model based on City of Renton mini-basins. There are 67 sewer drainage mini-basins. The mini-basins vary in size and span the entire City. These include the 57 King County Mini-Basins delineated for the year 2001-2002 flow monitoring, which were modified to more accurately represent the City's service area and to exclude non-developable areas, and to also add Mini-Basins A and B. Mini-Basin 38 was split into two sub-basins, as discussed in the September 2006 report, and Mini-Basins U1, U2, U3, U4, U6, U8, and U9 were added to address the development in the eastern portions of the City Sewer Service Area. These were originally delineated for the previous Ultimate analysis, but have incorporated some development since that time. Mini-Basin 30C, which was formerly part of Basin 30A, was created, and Basin 46 was split into two sub-basins, Mini-Basin 46 and 46-North. Other minor adjustments were made to some of the basins boundaries due to additional development and improvements to the network.

Figure 3-1 displays the mini-basin boundaries used in conjunction with the 2012 model.

Ultimate Model

The planning area boundaries are determined by physical service area agreements between the City and other jurisdictions, including adjacent Cities and Sewer Utility Districts. The Urban Growth Boundary designated by the King County Comprehensive Plan determines much of the easterly planning boundary areas. Most of the projected sewer area growth will occur to the areas east of the current City limits, including a large non-sewered area within unincorporated King County in the East Plateau service area.

Several Mini-Basin boundaries were expanded to include the City's sewer planning area for the "Ultimate" conditions, so that the entire population projected to be served by the City and the resultant sanitary sewage flows would be represented. Topography and other geographic features were taken into account when creating the new boundaries.

Three Basins east of the City, identified as U5, U7, and U10 included in the Ultimate model, were also delineated for the previous Ultimate analysis. Basins U5, U10, and the eastern portion of U9 are outside the East Plateau Service Area but

Figure 3.1
2012 Sewer Mini-Basin Boundaries

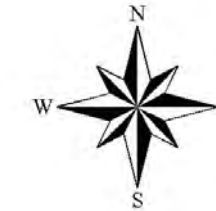
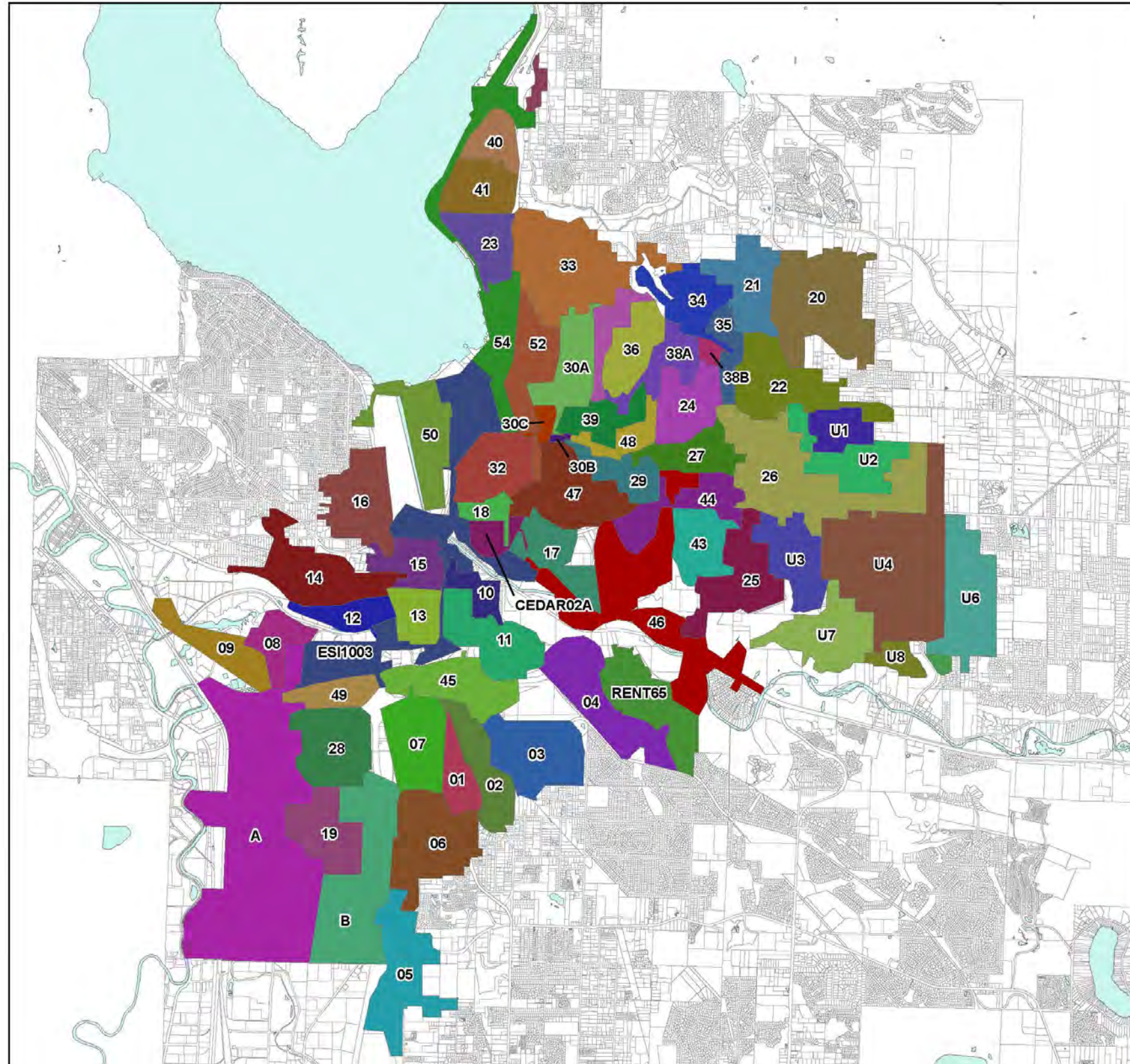

Figure 3-1
City of Renton
2012 Sewer Mini-Basin Boundaries



Figure 3.2
Ultimate Sewer Mini-Basin Boundaries

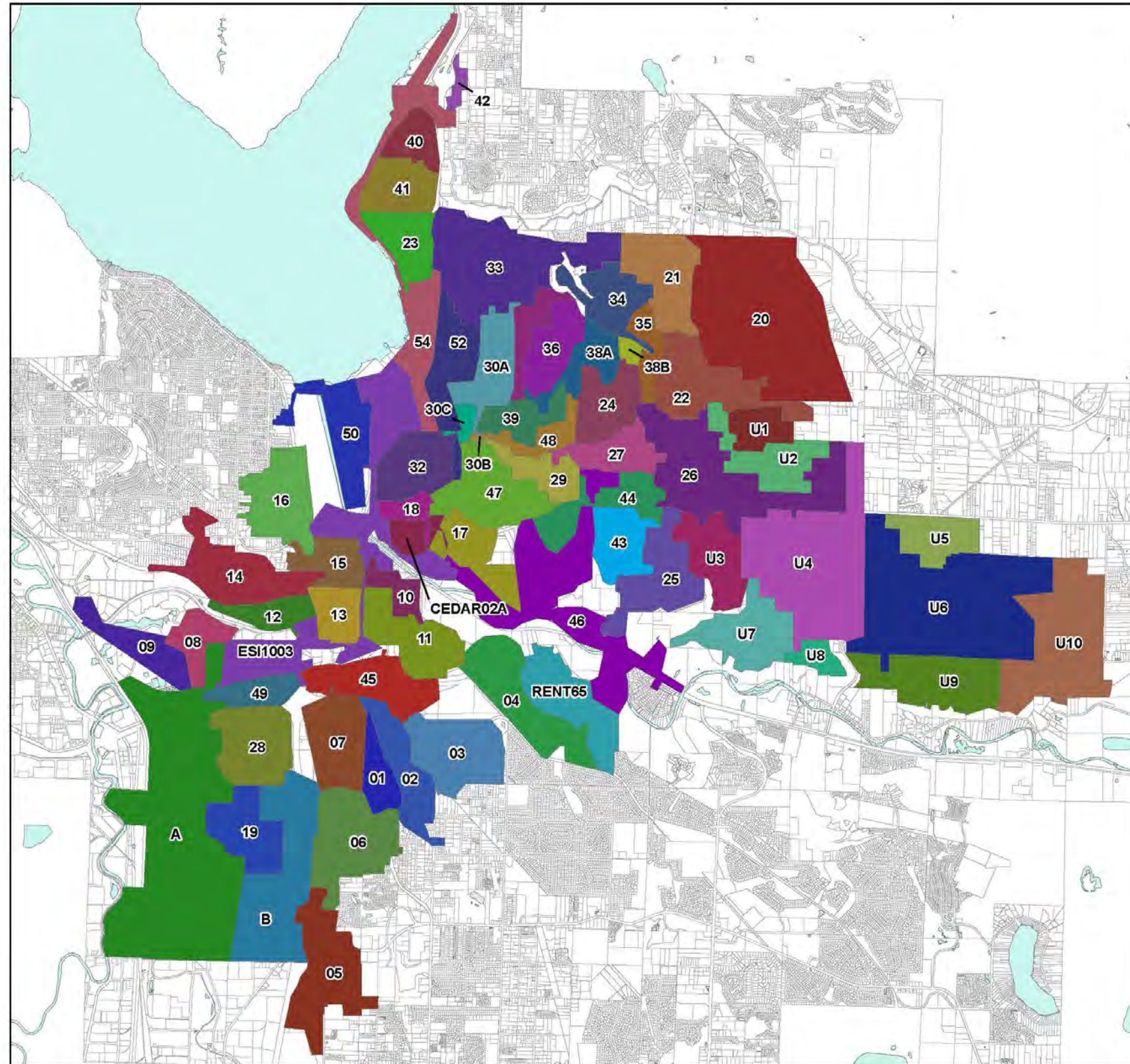

Figure 3-2
City of Renton
Ultimate Sewer Mini-Basin Boundaries



within the Ultimate Sewer Service Area. The areas of proposed future growth were represented in the model, as a “skeletonized” system. Large portions of the other U-Basins, including U4 and U6, are also currently without sewer.

Undeveloped portions of the U-Basins were generally represented in the model by single nodes in the approximate centers of the proposed service areas, connected to the appropriate discharge locations. Additionally, single nodes were assigned as “point” loads at various locations in the model, where significant proposed future service area is projected to connect to the existing system.

Figure 3-2 shows the mini-basin boundaries used in conjunction with the Ultimate Model.

Land Use and Zoning

The land use and zoning map, adopted September 22, 2014, was obtained from the City’s geodatabase and used for the planning data. The land use and zoning designations within the City include single-family residential (generally ranging from 1 to 14 dwelling units per acre), several classifications of multifamily residential, office, commercial, business, urban-center, and industrial zoning. There are also many parks and open spaces in and around the City. Population assigned to the model was grouped into the following four categories: single-family residential, multifamily residential, employment, and schools. For the 2012 model, population was assigned to the appropriate categories in the model by overlaying the land use and zoning map with the map of the sewer system, and separating the manholes into the four categories. Population was generally not assigned to manholes within parks and open areas.

Future land use and zoning patterns used in the Ultimate Model for the planning area were assumed to very closely correspond to existing uses (with a few exceptions), based on discussions with the City Planning Department and Planning/Building/Public Works Staff.

Data Projections

Population, household, and employment data was provided by the PSRC for the years 2012 and 2040 for the entire sewer planning area (both inside and outside current City limits). The data obtained for these years was provided in geographic subdivisions based on the sewer Mini-Basin boundaries provided to PSRC by Stantec. With a few exceptions, each Mini-Basin included projected growth of households and employment.

Residential

PSRC provided 2012 residential projections for the entire City of Renton Sewer Service Area utilizing Land Use Baseline data. These projections included estimated populations for single family and multi-family populations.

The Land Use Baseline projections are available down to the parcel level. However, the data was not been verified at this precision, and may contain some inaccuracies. Also, PSRC did not provide verification for its cut of the data at the mini-basin level, so we reviewed the data to determine if there were any obvious inaccuracies. This was done by reviewing City GIS data within each mini-basin, including land-use, parcel count, and aerial photos. King County Assessor's information, via King County's online GIS interface, iMap, was also checked to estimate volume of larger multi-family developments. Based on this review, the populations for the following basins were modified:

- Basin 5 – The Land Use Baseline projections list 126 parcels and a single family residential population of 169. City GIS data shows 170 parcels within the basin, with an estimated 100 single family lots. A multiplier of 2.5 persons per single family lot was used to estimate a single family residential population of 250 for this basin. The multi-family population supplied by PSRC is negligible, and is consistent with the city GIS data.
- Basin 20 – The estimate from PSRC for this mini-basin encompassed the Ultimate mini-basin boundary. To estimate the population for the current boundary, the total of 3,007 people was scaled on an area ratio of the current/ultimate basins for an adjusted population of 2,390. The multi-family development and zoning is all within the current mini-basin boundary, so this population was not modified.
- Basin 25/Basin 43 – Both of these mini-basins include large mobile home parks, which are not accounted for in the PSRC projections for either single-family or multi-family populations. Basin 25 includes approximately 240 mobile homes, and Basin 43 includes approximately 200 mobile homes. To account for these populations, a multiplier of 1.8 (multi-family) was applied to each mobile home, and the populations were added to the projections supplied by PSRC. For Basin 25, the total residential population was adjusted from 983 to 1,415. For Basin 43, the population was adjusted from 49 to 410.
- Basin U1 - The Land Use Baseline projections list 58 parcels and a single family residential population of 255. City GIS data shows approximately 205 parcels within the basin, with an estimated 197 single family lots. A multiplier of 2.5 persons per single family lot was used to estimate a single family residential population of 490 for this basin. The multi-family population supplied by PSRC is negligible, and is consistent with the GIS data.
- Basin U6 – The estimate from PSRC for this mini- basin encompassed the ultimate mini-basin boundary. To estimate the population for the current boundary, the total of 2,050 people was scaled on an area ratio of the current/ultimate basins for an adjusted population of 1,345. The multi-family population supplied by PSRC is negligible, and is consistent with the GIS data. It was not modified.

- Basin U9 – The estimate from PSRC for this mini-basin encompassed the ultimate mini-basin boundary. To estimate the population for the current boundary, the total of 1,268 people was scaled on an area ratio of the current/ultimate basins for an adjusted population of 68. No multi-family population was projected. This is consistent with the GIS data.

These modifications were reviewed by City of Renton Planning Department staff and accepted.

Employment

Using Land Use Baseline data, PSRC provided 2012 employment projections for all but six mini-basins within City of Renton Sewer Service Area. Projections were not released for Basins 30C, 32, 50, 52, U3, and U8 due to confidentiality requirements by the Employment Securities Department.

For those six basins, Longitudinal Employer-Household Dynamics (LEHD) data, developed by the U.S. Census Bureau, was cut to the mini-basin boundaries. The data listed is for the year 2011, which was the most recent data available.

As with the residential data, the employment data was reviewed. However, since it is difficult to estimate employment populations for each business without performing a detailed analysis of each min-basin, no obvious discrepancies between the PSRC/LEHD projections and the GIS data were identified.

Schools

Using published data from the local school districts, including the Renton School District and Issaquah Schools, populations were determined for schools within the existing sewer service area. Student populations were generally developed using enrollment statistics for the 2011-2012 school year. Where available, school staffing data was also collected and used to allocate employment population to the schools in the model.

Future Population Projections

Residential

PSRC provided 2040 residential projections, using the Land Use Baseline data, for the entire City of Renton Sewer Service Area. These projections included estimated populations for single family and multi-family populations. Since these projections were modeled using a large number of factors, it is difficult to review them solely on zoning and land use designations. Because of this, none of the residential projections were modified from the PSRC output, with the following exception:

- As part of the Thunder Hills Sanitary Sewer Interceptor analysis, A detailed review of the projections for the the tributary areas was performed. It was

determined that The PSRC projections for Mini-Basin 45 (which is tributary to the Thunder Hills interceptor) for the year 2040 showed large decreases in single and multi-family residential population, which is inconsistent with the City's Comprehensive Plan land use designations and current development activity for the basin. Because of this, Stantec developed Ultimate populations for the portions of Mini-Basin 45 tributary to the Thunder Hills Interceptor by applying the growth percentages calculated for adjacent Mini-Basin 3 based on PSRC estimates.

Employment

Future employment projections fall under the same restrictions as the current population data, so PSRC provided 2040 employment projections, using the Land Use Baseline data, for all but Basins 30C, 32, 50, 52, U3, and U8. Long-term LEHD data is not developed, so this methodology could not be used for future projections.

PSRC provided employment projections for its Land Use Targets dataset, which are based on local growth targets that are aligned with the Vision 2040 Regional Growth Strategy. This data is divided by TAZ (Traffic Analysis Zone), which is the smallest delineation of the data made available to the public by PSRC. No similar data set is available for the Land Use Baseline data. The long-term horizon for these projections varies by city, since they were based on each City's comprehensive planning period. For the City of Renton, year 2035 was the longest-term projection.

To allocate this population data to the future sewer mini-basins, we divided the populations for each TAZ into the mini-basins and using an area percentage of each mini-basin within the overlapping TAZ. A TAZ may still include multiple basins, city boundaries, and the UGA boundary in some cases. Each TAZ may also include areas of varying residential and employment density due to land-use designations. Because of this, a strict area to population ratio may not be an adequate representation of the employment population. The projections for two of the six mini-basins appeared to be reasonable. However, there were concerns about the projections for the other four mini-basins. Concerns and comments for the six mini-basins, which were presented with the population projections to the City Planning Department staff, are described below:

- Basin 30C – This basin is located in portions TAZ Zones 325, 324, and 325. The developable areas within this basin are entirely residential at this time, and have residential zoning and land use designations. A low or negligible employment population would be anticipated.
- Basin 32 – Almost this entire basin is located in a portion TAZ Zone 324. Approximately 50% of the basin has industrial land use designations, while the rest of the basin is a mixture of urban center, residential and commercial land-use designations. Much of the TAZ Zone 324 is south of Basin 32, and includes large areas with Commercial Corridor and Urban Center Downtown

land use designations, where more of the employment population is likely to be located. Because of this, it appears that the employment projections for Basin 32 are high.

- Basin 50 – Most of this basin is located in a part of TAZ Zone 323, with a small portion in Zone 335. The land use designations are Urban Center North, Industrial, and Commercial Corridor. Although there are commercial and industrial land use designations outside of Basin 50 for both TAZ zones, the employment population distribution does not appear to be disproportionate.
- Basin 52 - This basin is located in portions of TAZ Zones 322, 323, 324 and 325. The land use designations within the basin are residential and industrial. The area within Basin 325 is not developable. The employment population within Zone 323 does not appear to be disproportionate. However, the employment population projections for Zones 322 and 324 appear to be high, for similar reasons as for Basin 32.
- Basin U3 – This Basin is located within parts of TAZ Zones 327 and 328. The land use designations within the basin are primarily residential, but there is a small area of the basin within Zone 322 with a commercial designation. Zone 327 contains a large cross-section of residential and commercial land-use designations, so it is difficult to assess whether the employment population projections within Basin U3 are accurate.
- Basin U8 - This basin covers a comparatively small area in relation to the other basins. It is located within TAZ Zone 328, and the land use designation is all single-family. Zone 328 included only single family residential land use designations, so the employment population should be negligible.

The comments and data were reviewed by City of Renton Planning Department staff, and the population data was accepted.

The 2040 data is considered to be Ultimate built-out population by City Planning Staff. For hydraulic modeling purposes, most populations assigned to the model were increased by an additional 25% per the City's direction, to ensure an adequate level of conservatism for the Ultimate scenario.

Schools

Since school enrollment projections are not available for 2040, school population estimates were determined by applying the residential growth rate between 2012 and Ultimate conditions from the surrounding mini-basin. School staffing was similarly adjusted to compensate for adjustments in school population.

POPULATION AND SANITARY SEWAGE FLOW ASSIGNMENT TO MODEL

Population Assignment

Individual (per capita) flow rates were assigned to the residential and employment population, consistent with the flow rate assigned to each Mini-Basin in the original model, and later adjusted during the dry weather calibration process. Allowances were made for large concentrations of population or employment. The following outlines some of the main considerations for the process of population assignment to the model:

- Population was generally assigned to manholes in four main categories: residential single-family, residential multifamily, employment (commercial/industrial, etc.), and schools. Population and employment numbers for each composite mini-basin were apportioned among each zoning category to achieve uniform flow distribution.
- Population was generally assigned to most of the nodes in the model. Population was usually not assigned to the nodes associated with parks/open space, non-served areas (transmission areas), lift stations, and bends (population was assigned to Tees); these nodes were separated from the others and excluded from the population assignments.
- Per the City, typical sewage flows for the residential category are generally in the 60 to 100 gpcd range (not including I&I). Sewage flows from multifamily individuals are typically about 2/3 of the flows from single family individuals.
- Sewage flows for the employment category were generally assumed to be 10 gpcd (not including I&I), unless other information about higher demands was available or apparent, or as necessary for calibration.
- Sewage flows for the school category were generally assumed to be 10 to 15 gpcd (not including I&I), unless other information about higher demands was available or apparent. These values were roughly consistent with average school flow rates from Table 2-4 of Wastewater Engineering by Metcalf and Eddy (1991).

In areas where the mini-basin boundaries remained constant (no increase in area), and no significant sewer improvements were added, generally the projected population was evenly distributed among the existing nodes. Where mini-basin boundaries expanded for the Ultimate Model, the population was often increased by 25-50% for the existing manholes, and new area and new projected population was generally assigned to new manholes or projected single point-loads outside of and connected to the existing system. These populations were estimated based on zoning and area.

Table 3-1 summarizes the population and area assignments by mini-basin in the 2012 Model and the Ultimate Model. The population was separated into residential single-family, residential multifamily, employment, and school categories. This table updated the population assignments provided in the “City of Renton Hydraulic Model Update – Population Projections” memo dated June 18, 2014.

Determination of Sanitary Sewer Flow Rates

The per capita sanitary sewage flow rates developed during the creation of the 2001 Mouse model were generally used in the 2012 and Ultimate models. A description of the process for flow rate development is included in the text of the documentation report. Flows for new catchments within existing basin were initially assigned the same flows as existing adjacent areas based on development, and adjustments were made during the model dry weather calibration.

**Table 3-1
Population Projections by Sewer Mini-Basins:
Values Assigned to 2012 and Ultimate Models**

Sewer Mini-Basin	2012 Basin Population Estimates				Ultimate Population Estimates (2040 Population+25%)				Area (acres)		
	Single Family	Multi-Family	Employment	Schools	Single Family	Multi-Family	Employment	Schools	2012	Ult	% Diff
1	180	82	22	0	554	420	29	0	71.8	71.8	0.0%
2	81	1,303	342	1,041	209	1,608	713	1,367	127.5	134.7	5.7%
3	1,012	1,307	95	0	1,660	1,836	248	0	194.5	194.5	0.0%
4	1,094	49	22	466	2,109	121	160	909	205.2	205.2	0.0%
5	250	1,823	4,126	0	701	2,238	5,633	0	213.9	233.5	9.2%
6	1,513	10	25	0	2,173	14	165	0	224.3	224.3	0.0%
7	1,232	27	67	526	1,936	31	88	822	162.6	162.6	0.0%
8	0	0	2,248	0	0	0	5,310	0	82.1	82.1	0.0%
9	0	0	272	0	0	0	645	0	111.0	111.0	0.0%
10	173	121	537	0	201	65	1,011	0	54.4	54.4	0.0%
11	803	461	1,140	0	1,148	559	2,201	0	163.8	163.8	0.0%
12	23	1,492	458	0	34	1,803	883	0	73.6	73.6	0.0%
13	402	438	698	0	398	498	1,301	0	81.1	81.1	0.0%
14	1,041	401	504	298	1,795	483	1,088	471	206.0	206.0	0.0%
15	110	456	736	1,218	139	576	1,504	1,539	92.3	92.3	0.0%
16	1,077	380	241	0	1,534	481	583	0	177.2	177.2	0.0%
17	545	149	202	0	765	355	379	0	122.7	122.7	0.0%
18	350	209	148	0	408	280	279	0	38.9	38.9	0.0%
19	0	0	1,480	0	0	0	3,496	0	144.4	144.4	0.0%
20	2,390	490	261	0	5,943	549	973	0	309.5	620.7	100.5%
21	1,425	17	59	618	1,998	35	335	871	143.5	176.5	23.0%
22	1,065	1,433	599	1,956	1,690	1,905	2,049	2,815	208.8	208.8	0.0%
23	858	393	52	0	1,228	500	98	0	111.8	111.8	0.0%
24	1,258	136	63	0	1,839	179	109	0	130.5	130.5	0.0%
25	1,583	35	111	0	1,321	90	200	0	179.8	179.8	0.0%
26	2,189	1,440	818	525	3,270	2,228	1,800	795	382.5	382.5	0.0%
27	1,097	62	11	1,135	1,434	86	1,209	1,489	103.0	103.0	0.0%

**Table 3-1
Population Projections by Sewer Mini-Basins:
Values Assigned to 2012 and Ultimate Models**

	2012 Basin Population Estimates				Ultimate Population Estimates (2040 Population+25%)				Area (acres)		
28	0	0	5,365	0	0	0	12,673	0	180.0	180.0	0.0%
29	574	120	16	2,265	770	188	44	3,127	85.8	85.8	0.0%
30A	787	835	60	0	941	1,688	139	0	133.6	133.6	0.0%
30B	38	3	0	0	55	63	0	0	4.7	4.7	0.0%
30C	2	324	12	0	95	499	106	0	21.2	21.2	0.0%
32	321	281	105	0	368	328	5,373	0	141.8	141.8	0.0%
33	3,184	11	218	559	4,903	18	398	861	320.6	375.9	17.3%
34	721	227	43	0	1,223	279	75	0	127.9	127.9	0.0%
35	328	224	113	0	438	314	313	0	60.1	60.1	0.0%
36	40	1,376	397	0	41	1,634	854	0	117.2	117.2	0.0%
37	256	352	257	1,159	341	494	451	1,592	69.1	69.1	0.0%
38A	642	253	469	0	808	370	1,091	0	91.2	91.2	0.0%
38B	47	17	2	0	55	63	0	0	16.7	16.7	0.0%
39	508	515	127	0	640	690	329	0	86.0	86.0	0.0%
40	593	87	33	0	776	113	63	0	74.9	74.9	0.0%
41	1,063	94	61	0	1,319	133	116	0	117.3	117.3	0.0%
42	0	0	147	0	0	0	329	0	20.1	20.1	0.0%
43	549	624	7	0	611	1,085	175	0	116.5	116.5	0.0%
44	282	578	487	0	361	835	909	0	127.9	127.9	0.0%
45	20	1,157	2,733	0	133	2,390	5,165	0	158.8	158.8	0.0%
46	1,994	615	679	0	2,431	741	1,469	0	390.0	390.0	0.0%
46 (North)	67	665	21	0	106	1,055	36	0	23.8	23.8	0.0%
47	777	1,496	606	0	1,089	2,628	1,269	0	196.3	196.3	0.0%
48	462	168	6	545	609	243	288	737	60.3	60.3	0.0%
49	12	0	544	0	15	0	1,284	0	71.9	71.9	0.0%
50	4	174	30	0	5	210	1,064	0	162.6	162.6	0.0%
52	597	6	187	0	1,054	5	1,028	0	148.1	148.1	0.0%
54	139	1,066	883	0	446	1,680	1,668	0	252.5	252.5	0.0%
A	4	0	4,975	0	5	571	11,753	0	857.2	857.2	0.0%
B	0	0	2,580	0	85	0	6,046	0	323.3	323.3	0.0%

**Table 3-1
Population Projections by Sewer Mini-Basins:
Values Assigned to 2012 and Ultimate Models**

	2012 Basin Population Estimates				Ultimate Population Estimates (2040 Population+25%)				Area (acres)		
CEDAR 02A	302	146	318	0	370	211	599	0	48.6	48.6	0.0%
ESI1003	237	620	7,126	0	255	1,108	14,185	0	403.9	403.9	0.0%
RENT65	561	526	189	0	1,115	811	569	0	178.1	178.1	0.0%
U1	255	8	7	0	1,004	8	16	0	75.5	75.5	0.0%
U2	1,054	56	23	0	2,014	61	51	0	139.0	139.0	0.0%
U3	1,064	63	59	0	1,743	88	303	0	141.7	141.7	0.0%
U4	2,927	10	251	612	4,649	30	614	975	472.0	472.0	0.0%
U5	N/A ¹	N/A ¹	N/A ¹	N/A ¹	976	75	36	0	N/A ¹	112.9	
U6	1,345	6	32	1,664	4,055	33	544	3,309	219.9	615.2	179.8%
U7	N/A ¹	N/A ¹	N/A ¹	N/A ¹	1,685	9	96	0	N/A ¹	173.7	
U8	294	0	3	0	496	0	26	0	43.0	43.0	0.0%
U9	68	0	1	905	1,824	0	314	1,305	12.2	212.7	1641.9%
U10	N/A ¹	N/A ¹	N/A ¹	N/A ¹	2,335	178	64	0	N/A ¹	354.0	
Total	43,869	25,417	44,506	15,492	76,731	37,869	104,414	22,984	10,407.7	12,070.3	

1. Basin U5, U7, and U10 are not located within the existing sewer service area.

The same per capita flow rates and diurnal curves were used in both the 2012 and Ultimate Models for the portions of the system common to both models. These per capita flow rates were computed as part of the dry weather calibration for the 2012 Model. For population assigned to manholes located in the U-Basins, 100 gallons per person per day was assumed for residential population, and a peaking factor of 2.0 was globally applied to this flow rate. Twenty (20) gallons per person per day was assigned for employment population, per direction from the City Staff. For new schools in the projected service area, 15 gallons per person per day was assigned to the model. With this methodology, calibrated diurnal curves were applied to the existing manholes, and an averaged flow rate was applied to population assigned to new manholes.

Input to Model

Flows for the newly-added portions of sewer system were assigned to new catchments. Numbering methodology is consistent with the original model development, and was assigned in sequential order. In cases where portions of the sewer system were upgraded or re-routed, existing catchment information was re-assigned to new manholes.

Area Assignments

For the older portions of the model, area assignments were generally not modified from the original MOUSE model development. A description of the process for area assignment is included in the text of the documentation report.

For portions of the 2012 model developed in Mike Urban, the City parcel GIS data was overlaid in the model, and catchments were drawn directly over these developments. Where the new development included multiple manholes, a routine in Mike Urban automatically divided the catchments among the manholes within the development boundary. If additional manholes were added to a mini-basin with a constant boundary, the areas of the older surrounding catchments were reduced.

Areas assigned to the Ultimate Model were generally consistent with the methodology used for area assignments to the 2012 Model. Additionally, "dummy" nodes were added to represent future projected growth areas within the proposed service area boundaries. Large areas (point loads) were added to these dummy nodes to represent the discharges to the system from future growth. For example, several dummy nodes were used in the portions of the U-Basins where gravity sewer systems have not yet been constructed.

RAINFALL AND EVAPORATION ASSIGNMENTS

Rainfall Assignments

King County developed model basin specific precipitation time series as part of its 2001 I&I study by using Doppler radar to identify the varying precipitation patterns between rain gauges and factoring the gauge data accordingly. These precipitation data sets were developed for a 60-year period based from SeaTac data, and spliced with local rain gauge data for the period of time the County flow monitors were in place, resulting in a specific precipitation data set for each monitoring basin. Each Model Basin was assigned 60 years of factored data coupled with two years of more exact measured precipitation data. These rainfall time series were used in the original MOUSE model analysis, and most of the subsequent model analyses performed for the City. King County used these time series for its recent analysis, so they were also used for the City's 2012 models.

For system improvements constructed within the U-Basins, a global I&I assignment of 1,500 gallons per acre per day was assumed and connected to the model.

Evaporation

Evaporation data was obtained from the historical Puyallup pan evaporation data record. The data is no longer collected at that location and no other known sources of evaporation data exist in the area. As a result, historical monthly averages of the Puyallup data were determined and input to the model. The County adopted a similar average monthly approach to input evaporation data into the model. A standard pan evaporation factor of 0.75 has been applied to the data. King County provided an updated evaporation time series which extends through 2015.

The rainfall and evaporation assignments assigned to the Ultimate Model were consistent with those applied to the 2012 Model. This rainfall data included 60-years of data spliced with two years of more specific rainfall data from King County's flow monitoring program. Each model basin had a separate targeted rainfall assignment which was applied consistently to all of nodes (catchments) contained within.

External Boundary Flows

Boundary flows enter the City of Renton Sewer Service area at multiple points in the system. Some of these flows discharge from other sewer systems into the City's sewers, while others flow into the King County sewers within the City's Sewer Service Area boundary. These boundary flows are described below:

- TUK015 – This boundary flow discharges through the Tukwila Trunkline into the South Interceptor on the west side of Mini-Basin A, and includes flows from King County Model Basins TUK015, TUK002, TUK004, VAL002, and VAL020 in southwestern King County. There is no direct discharge into City of Renton facilities. However, these flows can potentially impact the hydraulic grade line in City sewers tributary to the Tukwila Trunkline and South Interceptor.
- SINT020 - This boundary flow discharges into the South Interceptor on the south side of Mini-Basin A, and includes flows from King County Model Basins SINT020, AUBRN002, ULID066, ULID57C, ULIDN001, ULIDN003, SOO039, KNT035, KNT036, KNT042, and KNT047 located in south King County. There is no direct discharge into City of Renton facilities. However, these flows can potentially affect the hydraulic grade line in City sewers tributary to the South Interceptor.
- SOO021 - This boundary flow discharges into the South Renton Interceptor on the east side of Mini-Basin 5 from the Soos Creek Water and Sewer District, and includes flows from King County Model Basin SOO021. There is no direct discharge into City of Renton facilities. However, these flows can potentially affect the hydraulic grade line in City sewers tributary to the South Renton Interceptor.
- SOO003 - This boundary flow discharges into the City of Renton facilities on the south side of Mini-Basin 4 from the Soos Creek Water and Sewer District, and includes flows from King County Model Basins SOO003, SOOS67, NSOOS384, SOO051, SOOS62, and SOO011.
- CEDAR039A - This boundary flow discharges into the Cedar River Trunkline to the southeast of the City sewer service area, and includes flows from King County Model Basins CEDAR039, CEDAR010, CEDAR011, and CEDAR 012. There is no direct discharge into City of Renton facilities. However, these flows can potentially affect the hydraulic grade line in City sewers tributary to the Cedar River Trunk.
- RNT042 - This boundary flow discharges into the City of Renton facilities on the north side of Mini-Basin 42, and includes flows from King County Model Basin RENT042. Mini-Basin 42 is actually located within King County Model Basin RENT042. However, the City of Renton sewer service area flows are not modeled as boundary flows.
- ESI4024 - This boundary flow discharges into the Eastside Interceptor at the north end of the City Sewer Service area, and includes a tributary area encompassing Bellevue, Kirkland, and much of the area east of Lake Washington.
- BLS043B - This boundary flow discharges into the Bryn Mawr Trunkline on the northwest side of Mini Basin 50, and includes flows from King County Model Basins BLS007 and BLS43B. There is no direct discharge into City of Renton

facilities. However, these flows can potentially affect the hydraulic grade line in City sewers tributary to the Bryn Mawr Trunk.

Locations where the boundary flows enter the City of Renton Sewer Service Area are included in the model analysis results, **Figure 5-2** and **Figure 5-3**. Methods for simulating the boundary flows during the calibration and capacity analysis are discussed in Chapter 4 and Chapter 5.

CHAPTER 4 MODEL CALIBRATION

Model calibration consists of two primary tasks: sanitary and I&I calibration. It is important to distinguish between these separate components, to more accurately simulate future scenario changes in pipe flows related to changing population and employment as well as assumptions about I&I changes over time. Understanding the characteristics of these individual components of pipe flow is a key element in developing the model.

Calibration parameters were generally based on the guidelines found in the 2002 Wastewater Planning Users Group Code of Practice for the Hydraulic Modeling of Sewer Systems.

The code recommends that sanitary flow verification should be carried out for two dry weather days and the predicted flows/depths compared to the observed flows/depths. The two flow hydrographs should closely follow each other both in shape and in magnitude. In addition to the shape, as a general guide, the flow hydrographs should meet the following criteria:

- The timing of the peaks and troughs should be within 1 hour.
- The peak flow rate should be in the range $\pm 10\%$.
- The volume of flow should be in the range $\pm 10\%$. Care should be taken to exclude periods of missing or inaccurate data.

For wet weather calibration, modeled flows/depths should be compared to the observed flows/depths. The two flow hydrographs should closely follow each other both in shape and in magnitude, until the flow has substantially returned to dry weather flow rates. In addition to the shape, as a general guide, the observed and modeled hydrographs should meet the following criteria in at least two of the three events:

- The timing of the peaks and troughs should be similar in regard to the duration of the event.
- The peak flow rates at each significant peak should be in the range + 25% to - 15% and should be generally similar throughout the event.
- The volume of flow should be in the range +20% to -10%. Care should be taken to exclude periods of missing or inaccurate data.
- The depth of surcharge should be in the range +0.5 m to - 0.1 m.
- The unsurcharged depth at any key points, where this is important regarding the objectives of the model (e.g. at combined sewer overflows), should be within the range ± 100 mm.

Where rainfall induced infiltration is modeled, the use of a single verification period incorporating a number of rainfall events should be considered instead of a number of discrete events.

For the purposes of this model calibration, for both sanitary and wet weather, peak flow and volume parameters for the model were verified against the flow monitoring data, as well as a comparison of general flow patterns and timing of peaks.

2012 MODEL DRY WEATHER CALIBRATION

Sanitary Flow Calibration

Sanitary calibration consists of two primary elements: the total flow produced per person over a 24-hour (diurnal) period and the definition of how that flow fluctuates over the same period. This information, combined with the previously discussed population and employment data, generate the total sanitary flow simulated in the model.

Prior to determining per capita flow rates and diurnal fluctuations, periods of “dry weather” flow have to be identified for the County flow monitoring data. A dry weather period in September 2010 was analyzed for the dry weather calibration. Since dry weather flow typically includes a component of low level or base I&I, it must be estimated and subtracted from the total flow, leaving presumably sanitary flow only. Base I&I values were determined by estimating typical minimum (nightly) sanitary flow as a percent of average and assuming the balance is base I&I. Base I&I was assumed to be constant throughout the day.

Residential flow typically varies throughout the day in a different manner than commercial/industrial sanitary flow. Residential flow generally peaks twice during the day, while commercial/industrial flow typically increases in the morning, stays relatively constant during the day, and decreases in the evening. Numerous exceptions exist to these generalized variations however. Commercial/industrial flow for example can exhibit all manner of daily variations, depending on the nature of the business conducted at the location. A thorough understanding of these businesses is required to accurately simulate the daily fluctuations and achieve a detailed sanitary flow calibration. It is possible however, to achieve an accurate calibration by applying the composite diurnal variation recorded at the flow monitor to both residential and commercial/industrial development throughout the basin represented by the flow monitor. Lacking extensive knowledge of commercial/industrial developments and additionally to expedite the calibration process, this was the method selected to determine the sanitary flow calibration. This method allows for a quick, accurate calibration, but could potentially result in misrepresentation of diurnal fluctuations in future scenarios, if the balance between residential and commercial/industrial populations changes significantly. The potential shortcomings are considered to be negligible however, especially since it is difficult to accurately forecast how anticipated additional commercial/industrial flows will vary in the future.

Dry weather calibration was verified by performing a sanitary flow model simulation, using the data assigned to the catchments and dry weather flow entries. External boundary flows were simulated by attaching time series of the flow monitoring data from the August-September 2010 period. The resulting basin

outlet flows were compared to the County “dry day” flow monitoring data. If the curve shape generated by the model (Model Output) generally matched the metered curve shape (Model Input) and the total daily volume was within 10%, the basin was considered calibrated for sanitary flow. Output graphs of the computed dry weather flows versus the measured King County flows (excluding the base I&I) were generated for each mini-basin. The dry calibration resulted in computed model peak flows and volumes that closely simulated the measured flows in six of the eleven locations analyzed. In some cases, including RNT41, RNT43, and SRENT002, the modeled peaks and volumes were much higher than the recorded flows. However, in these basins, the modeled peak per capita flow rates were already low based on population and land use. These were not adjusted further to match the flow monitoring data. Some of the discrepancy in overall volume in these basins is due to significant “noise”, or small peaks, in the flow monitoring data, in addition to the per capita flow rate assumptions. The model output is much smoother, which leads to significant differences in volume. Because of this, the overall shape of the model output was compared against the flow monitoring data. We were generally more focused on closely simulating the peak dry weather flows rather than the volumes, to be conservative, and also due to the “noise” and drop-outs in the flow monitoring results. Overall, the shape and timing of the patterns adequately matches the flow monitoring data.

Flow monitoring data was not available for the boundary flows at SINT020 and BLS043, so constant dry weather flows were estimated. These two boundary flows do not flow through City sewers, so the impact to the dry weather calibration is negligible.

A number of model basins were not calibrated with 2010 flow monitoring data, as are noted in the next section in Table 4-4. For those, the per capita flow rates from the original model calibration were maintained in this model. The basins that were calibrated as part of this project were calibrated in 2015, while the others were calibrated in 2005.

The calibration for RNT030B and RNT047 were only partially successful. Since RNT035 is upstream of both RNT030B, and could not be recalibrated, it was difficult to adjust the dry weather flow parameters within RNT035. There were similar difficulties with RNT047.

A dry weather calibration summary is provided in Table 4-1. The summary lists the percentage deviation of the calibration model results from the flow monitoring data for peak flow and total volume of flow over the duration of the analysis. Annotated plots of the dry weather calibration time series are provided in the Appendix A.

**Table 4-1
Dry Weather Calibration Summary**

Model Basin	Pipe Diameter (in)	September 1, 2010 to September 8, 2010	
		Peak Flow (%)	Volume (%)
RNT017	15	-1.8%	-4.7%
RNT023	8	10.5%	6.0%
RNT025	12	4.4%	6.4%
RNT028	24	-9.1%	-0.9%
RNT030A	21	-9.4%	11.3%
RNT030B	18	27.1%	23.9%
RNT041	8	26.3%	96.6%
RNT043	8	15.0%	54.6%
RNT047	24	27.0%	58.2%
RENT65	20	6.1%	12.2%
SRENT002	36	19.6%	45.6%

Peak weekday per capita flow rates for residential, employment and school populations in each mini basin are provided in Table 4-2. Employment flow rates for Mini-Basins 9 and 11 greatly exceed the flow rates in other basins. These were calibrated in 2005. Flow monitoring data was not available to re-calibrate these Mini-basins in 2015.

Table 4-2
Per Capita Flow Rate (ft²/PE/day)

Sewer Mini-Basin	Residential	Employment	Schools	Calibration Year ⁽¹⁾
1	13.77	N/A	N/A	2015
2	10.49	1.34	2.01	2015
3	12.21	N/A	N/A	2015
4	13.37	N/A	1.34	2015
5	10.69	N/A	N/A	2015
6	10.69	2.67	N/A	2015
7	10.45	1.34	1.34	2015
8	14.20	N/A	N/A	2005
9	N/A	21.05	N/A	2005
10	8.71	1.34	N/A	2005
11	13.37	69.35	N/A	2005
12	13.37	2.12	N/A	2005
13	10.87	1.34	N/A	2005
14	10.69	5.85	2.01	2005
15	13.37	2.55	2.01	2005
16	8.69	1.34	N/A	2005
17	10.23	1.34	N/A	2015
18	8.86	1.34	N/A	2005
19	N/A	5.24	N/A	2015
20	6.31	1.34	N/A	2015
21	12.88	N/A	1.34	2015
22	7.13	1.34	1.00	2015
23	12.17	1.34	1.34	2015
24	8.60	1.34	N/A	2015
25	8.02	1.34	N/A	2015
26	10.51	1.34	1.34	2005
27	8.02	1.34	1.33	2015
28	N/A	3.80	N/A	2005
29	9.80	1.34	1.34	2015
30A	9.36	1.34	N/A	2015
30B	N/A	1.34	N/A	2015
30C	9.36	1.34	N/A	2015*
32	11.53	1.34	1.34	2005
33	11.34	1.34	1.34	2015
34	12.03	1.34	N/A	2015
35	10.69	2.70	N/A	2015
36	11.18	1.34	N/A	2015
37	10.23	1.34	1.34	2015

**Table 4-2
Per Capita Flow Rate (ft²/PE/day)**

Sewer Mini-Basin	Residential	Employment	Schools	Calibration Year ⁽¹⁾
38A	9.36	1.34	N/A	2015
38B	9.36	1.34	N/A	2015
39	12.67	1.34	N/A	2015
40	8.25	1.34	N/A	2005
41	10.14	1.34	N/A	2015
42	N/A	2.67	N/A	2005
43	1.34	9.90	N/A	2015
44	9.36	1.34	N/A	2005
45	8.25	1.37	N/A	2015
46	9.36	1.34	N/A	2005
47	8.06	0.67	N/A	2015
48	9.84	1.34	1.00	2015
49	0.67	8.06	N/A	2015
50	N/A	3.23	N/A	2005
52	10.56	1.34	N/A	2005
54	12.17	2.67	N/A	2005
A	N/A	2.67	N/A	2005**
B	N/A	2.67	N/A	2005**
CEDAR02A	10.69	2.67	N/A	2005
ESI1003	10.69	2.67	N/A	2005
RENT65	15.33	N/A	N/A	2015

(1) Per capita flow rates determined in the 2005 dry weather calibration were set using DWF at the Mini-Basin level. Those modified in the 2015 calibration were set at the model basin level.

* Basin 30C was calibrated with Basin 30A.

** Per capita flow rates for Basins A and B were not calibrated. During the 2005 model development, standard per capita flow rates based on land use were assigned, and diurnal curves from adjacent basins with similar land use were assigned.

2012 MODEL WET WEATHER CALIBRATION

Infiltration and Inflow Calibration

Infiltration and inflow is represented in the Mike Urban model as two individual components. The fast response component (FRC) is characterized by a rapid increase in pipe flow corresponding to a rainfall event. The rapid increase results in a sharp peak and is followed by a rapid decrease in flow. This type of flow typically comes from a direct hydraulic connection between an impervious or nearly impervious surface and the piping system. The slow response component (SRC) is characterized by a somewhat delayed response to a rainfall event, a smaller, broader peak and a relatively slower decrease in pipe flow. SRC flow is

generated from overland flow, near surface and groundwater intrusion into the piping system. SRC flow includes base I&I.

Mike Urban contains a choice of multiple options or models for generating I&I. Given the wealth of flow monitoring and precipitation data, it was decided to use the more complex RDII module to generate the SRC, consistent with the methodology employed by King County, and that used in the original MOUSE model development. The RDII module requires calibration to a number of parameter values that govern the algorithms defining the hydrologic process and the resulting potential inflow into the sewer collection system. When properly calibrated, the RDII module provides the best overall representation of the SRC. The FRC was generated using the "A" model, with simplified algorithms governing the timing, shape and volume of the hydrologic response.

The I&I calibration involved identification of parameter values for the SRC component (after sanitary calibration was completed) then development of the FRC component parameters, which essentially "finish off" the hydrographs. The County's 2008 through 2011 flow monitoring data was used for I&I calibration. There were a few significant storms over this period, including the December 12/13, 2010 storm, which produced a rainfall of approximately 2.5 inches over a 24-hour period, which is equivalent to a 10-year storm, based on King County Drainage Manual rainfall isopleths.

External boundary flows were simulated by attaching time series of the flow monitoring data from the December 12/13, 2010 storm. Other peak flow events were also considered. However, this was the only one where usable flow monitoring data was available for most of the model basins. As with the dry weather calibration, flow monitoring data was not available for the boundary flows at SINT020 and BLS043, so constant wet weather flows were estimated and assigned. Mike Urban RDII parameters are typically adjusted to match base I&I first, then peak flows resulting from rainfall events. Possibly the most important parameter controlling base I&I is the percent of total basin area contributing to pipe flow. A high base I&I, for example, can be simulated in the model by assuming a relatively high contributing area percentage, then adjusting additional parameter values to contribute a higher percentage of runoff to base flow versus surface runoff.

A wet weather calibration summary is provided in Table 4-3. The summary lists the percentage deviation between the model results and the flow monitoring data for peak flow and total volume of flow over the duration of the analysis. Six of the eleven model basins met standards for volume. The calibration for volume for RNT028 and RNT043 was not as successful, deviating from acceptable standards by approximately 5%. The volume deviation is significantly greater for RNT017. As with the dry weather calibration, this is due to significant "noise" in the flow monitoring data. RNT017 especially contains a lot of small peaks, whereas the model output is much smoother. This contributes to the large discrepancy in volume. Because of this, the overall shape of the model output RNT017, RNT028, and RNT043 was compared against the flow monitoring data. Overall, the shape and timing of the patterns matches the flow monitoring data. The flow monitor for RENT65 failed

Table 4-3
Wet Weather Calibration Summary

Model Basin	Pipe Diameter (in)	December 10, 2010 to December 18, 2010	
		Peak Flow (%)	Volume (%)
RNT017	15	3.0%	48.5%
RNT023	8	2.9%	17.8%
RNT025	12	1.2%	31.4%
RNT028	24	-4.0%	-16.1%
RNT030A	21	-6.9%	9.9%
RNT030B	18	4.7%	7.2%
RNT041	8	-6.5%	-10.7%
RNT043	8	9.4%	26.9%
RNT047	24	-9.7%	-11.1%
RENT65	20	N/A	N/A
SRENT002	36	5.7%	4.5%

Annotated plots of the wet weather calibration time series are provided in the Appendix B.

Non-Calibrated Model Basins

Several of the King County model basins had complications including faulty or missing flow-monitoring data, and inconsistent dry weather flow. **Table 4-4** identifies the City mini-basins that were not calibrated for dry and wet weather, with a brief explanation for each:

**Table 4-4
City Mini-Basins Not Calibrated for Dry and Wet Weather**

Model Basin	Mini-Basins	Reason Not Calibrated
19	19	Errant dry and wet weather flow monitor data, impossible to calibrate
45	1,3,7,35	Wet weather calibration not possible due to faulty flow monitoring data
35	20,21,22,35	Wet weather calibration not possible due to faulty flow monitoring data
Cedar02A	Cedar02A, 46	Errant dry and wet weather flow monitor data, impossible to calibrate
ESI1006	8,9,11,12, 13,14,15,16,32,49,50,54, ESI1003	Large geographic area. Could not isolate from upstream flow. Calibration not performed.

For the above-listed mini-basins, since wet weather calibration was not attainable, the RDII parameters from the original model calibration were maintained in this model, with minor adjustments to address increased I/I due to pipe degradation.

Ultimate Model Inflow and Infiltration Parameters

The calibrated I&I parameters used for the 2012 Model were applied to the Ultimate Model for the calibrated portion of model (sewer system constructed prior to mid-2002), except that the I&I was globally increased per King County's previous methodology, which assumes a 7.0% increase per decade, to a maximum degradation of 28.0% for Ultimate conditions. The ramifications of the system degradation-related I&I assumptions are discussed further in this report. For system improvements constructed for the Ultimate model, a global I&I assignment of 1500 gallons per acre per day was assumed and connected to the model.

2012 MODEL PEAK FLOW AND CAPACITY ANALYSIS

External Boundary Flows

In order to model in flows into the County's piping systems within the approximate City limits, discharge time series for the peak storms were developed from the County's 2012 I/I study MOUSE output, and assigned at upstream locations in the King County interceptors. For the boundary flows from SOO003 and RNT042, where output model data was not available, peak 20-year design inflows were assigned as constant inflow conditions. Although use of the County model output better simulates flows from upstream areas within the County system, variations between the King County Model and the Renton model contributed to some surcharging and capacity issues in portions of the system not shown in the County's results.

Peak Storm

For the prior analysis, the County provided a chart ranking the six highest peak flow-generating storm events within each model basin in the vicinity of the City. The peak storm events were determined by the County by routing 60 years of rainfall data through the County's calibrated model. The storms identified on the chart were assumed to roughly correspond (in decreasing ranking) to the 60, 30, 20, 15, 12, and 10-year design flow events.

Of the eleven model basins within the City boundaries, the County identified nine different storm events which generated the 20-year peak flows (third-ranked peak flow generating events) for the basins. Rather than running the model nine separate times to capture all of the 20-year events, four separate storm events were selected to generate the either the 20-year or 30-year peak flow rates for all eleven model basins. This simplified methodology was acceptable to the City staff. The selected rainfall events are summarized in **Table 5-1** below by model basin. Although King County modified some of its model basin boundaries for its 2012 I/I analysis, for the purposes of the City of Renton models, the original model basin boundaries developed for the 2001 I/I study were applied to the 2012 analysis. **Figure 5-1** shows the selected storm events for each model basin.

Figure 5.1
Selected Storm Events Per Model-Basin

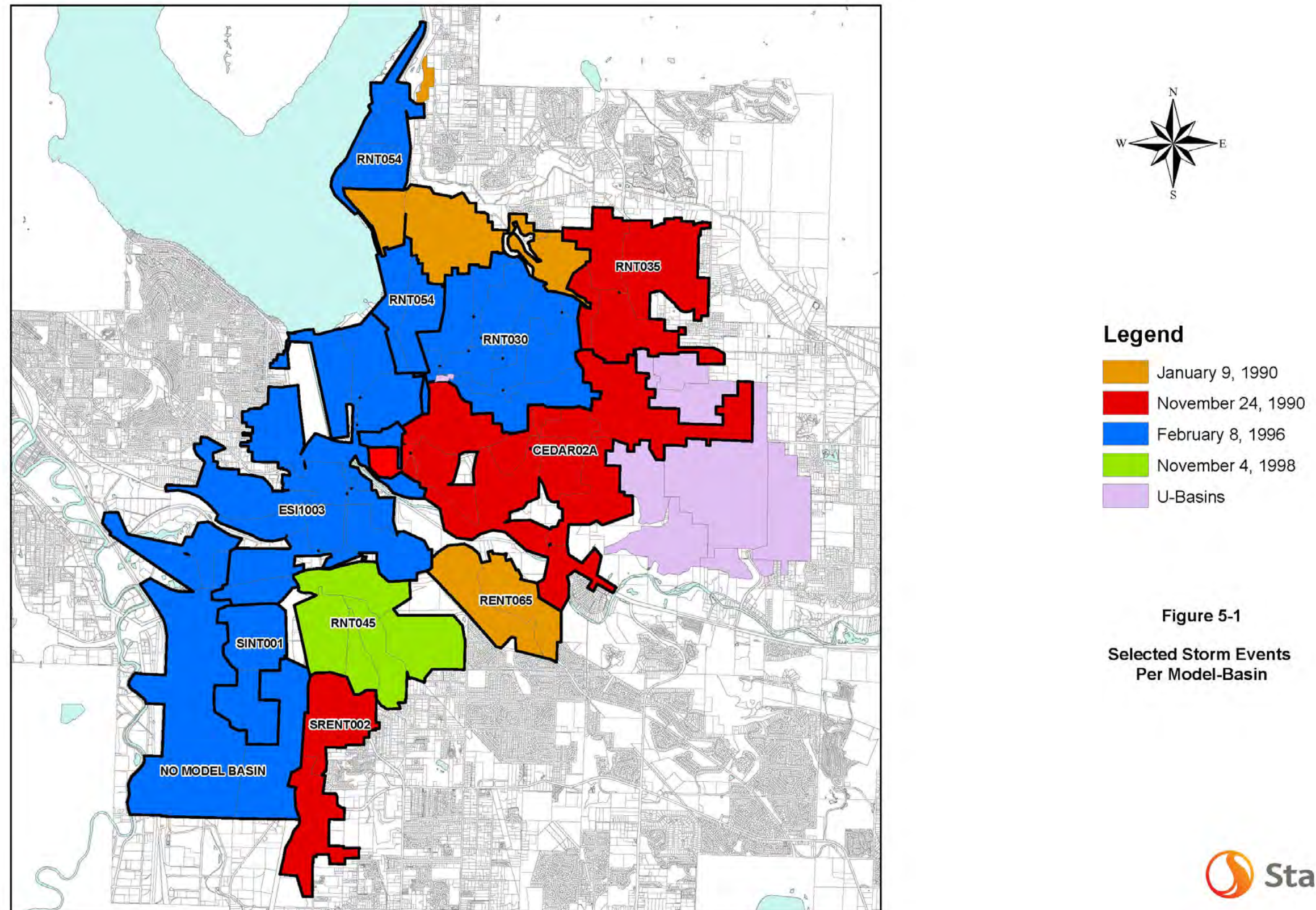

**Table 5-1
Selected Storm Events Per Model Basin**

Model Basin	Storm Event Modeled	Recurrence Interval Peak Flow
CEDAR02A	November 24, 1990	30-Year
ESI1006	February 8, 1996	30-Year
RNT023	January 9, 1990	30-Year
RNT030	February 8, 1996	20-Year
RNT035	November 24, 1990	30-Year
RNT042	January 9, 1990	20-Year
RNT045	November 4, 1998	20-Year
RNT054	February 8, 1996	20-Year
RENT65	January 9, 1990	30-Year
SINT001	February 8, 1996	30-Year
SRENT002	November 24, 1990	30-Year

In addition to the assignments listed in the table above, there were four mini-basins not calibrated by King County, and not included with the model basins (Mini-Basins RNT08, RNT09, A, and portions of Mini-Basin B), all of which are independently tributary to King County interceptors near the treatment plant. All four of these mini-basins were in the proximity of Model Basins ESI1003 and SINT001, and were similarly assigned the February 8, 1996 storm event.

Analysis Results

Figure 5-2 displays the overall modeled system with pipes color-coded by peak flows divided by maximum capacity (Q/Full) based on Manning's equation for the model analysis period. The map was color-coded as listed below:

Peak Q/full	Color
0.0 to 0.6	Gray
0.6 to 0.8	Blue
0.8 to 1.0	Green
1.0 to 1.2	Orange
Greater than 1.2	Red

All pipes with ratios greater than 0.8 are considered to be exceeding their capacity. Pipes colored blue indicate pipes that are close to but not exceeding this capacity standard. The map has individual areas with capacity problems identified. The problem areas were labeled based on mini-basins within the City. For example, if Mini-Basin 65 has two problem areas, they would be identified as 65A and 65B, respectively. Only City piping was identified in the problem areas. Areas where County piping exceeded 0.8 were not labeled.

Problem areas were classified by the degree of surcharging and summarized in **Table 5-2**, which is arranged by profile and includes a location description, the duration of surcharging above the crown of the pipe (where applicable), the duration of surcharging above manhole rims (where applicable), a brief listing of the suspected cause of the problem or any special conditions, and a ranking of the severity of the problem. The surcharging issues are ranked as Minor, Moderate, or Severe. Minor problems were classified as pipes with insignificant to no surcharging (often in the 0.8 to 1.0 Q/Q_{Full} category). Moderate problems represent areas with surcharging to more significant levels or durations, but contained within the sewer system. Severe problems represent areas with significant surcharging heights and durations and any areas with where the flow overtops the manholes. **Figures 5-2A to 5-2S** (which are referenced in the Table) are included in Appendix C, and provide zoomed-in views of the problem areas shown in Figure 5-2.

Attaching constant peak inflows for the boundary flows was conservative, as mentioned above. The constant inflows caused the discharge in some of the mini-basins to look non-standard, including Mini-Basins 4, 42, 46, and 65. For each of these mini-basins, the incoming constant peak boundary flow dominates the local flows, such that the peaks caused by the individual mini-basins do not appear to contribute as significantly to the total flow as may appear at some of the other mini-basins. Additionally, Mini-Basin 50 has severe surcharging issues in the King County trunk sewer, which significantly influences flows in the downstream system. The County has indicated it is aware of the capacity issues and is working to resolve them.

A table and figures detailing the discharge at the outlet of each mini-basin are summarized in the next section in **Table 5-3**, along with the output from the Ultimate Model.

**Table 5-2
Capacity Analysis for 2012 Sewer Model - Problem Areas**

Problem Area	Manhole No.		Storm Event	Rating	Mini Basin	Pipe Sections	Length and Diameter	Manhole Surchage (hrs)	Manhole Overtopping (hrs)	Max Surchage Height (ft)	Comments
	Upstream	Downstream									
04A	MH2795	MH2790	January 9, 1990	Minor	4	4	1083'-24"	Entire run	0	0.5'	Includes upstream flows from SCWSD. Pipe nearing capacity. Backwater due to downstream capacity issues.
	MH2790	MH2819		Minor	4	4	1140'-24"	Entire run	0	0.5'	Includes upstream flows from SCWSD. Minor capacity issues due to pipe size.
Location: See Figure 5-2A. Index Ct SE south of SE 16th St, off-road easement from Index Ct SE to Kirkland Ave SE to Beacon Way ROW.											
05A	MH2998	RE*SRENT.R18-19	November 24, 1990	Severe	5	3	807'-8"	15	14	5'	Capacity issues due to pipe size, backwater due to sharp bend at MH2996, MH2997
Location: See Figure 5-2B. Shattuck Ave S north of S 37th St near Talbot Rd S.											
05B	MH3217	RE*SRENT.R18-25	November 24, 1990	Moderate	5	2	672'-8"	4	0	1.5'	Capacity issues due to pipe size.
Location: See Figure 5-2B. Talbot Road S between SE Carr Rd and S 177th St.											
05C	MH3198	MH5523	November 24, 1990	Severe	5	9	1645'-8"	8	0	10'	Capacity issues due to pipe size, backwater due to sharp bend at MH3193, MH3194.

**Table 5-2
Capacity Analysis for 2012 Sewer Model - Problem Areas**

Problem Area	Manhole No.		Storm Event	Rating	Mini Basin	Pipe Sections	Length and Diameter	Manhole Surge (hrs)	Manhole Overtopping (hrs)	Max Surge Height (ft)	Comments
	Upstream	Downstream									
	MH5519	RE*SRENT.R18-17	November 24, 1990	Moderate	5	3	902'-12"	11	0	1.5'	Capacity issues due to pipe size.
Location: See Figure 5-2B. Davis Ave S off of S 43rd St near Talbot Rd S, and north through off-road easement towards S 37th St.											
5D	MH3205	MH3198	November 24, 1990	Minor/ Severe	5	2	474'-8"	7	0	9'	Pipe nearing capacity. Severe surcharging due to backwater in DS system.
Location: See Figure 5-2B. Off-road easement south of Davis Ave S off of S 43rd St near Talbot Road S.											
06A	MH3016	MH3004	November 24, 1990	Severe	6	7	2166'-8"	10	1	8'	Capacity issues due to pipe size, backwater due to sharp bend at MH3004, MH3009.
Location: See Figure 5-2C. Talbot Road S from S 27th Pl south toward 32nd St and off-road easement west of Talbot Rd S.											
07A	MH2479	MMH2257	November 4, 1998	Moderate	7	6	1551'-12"	1	0	4'	Minor capacity issues due to pipe size, bends. Minor surcharging from capacity problems in DS system.
Location: See Figure 5-2D. S 14th St from Shattuck Ave S to Smithers Ave S.											
07B	MH2270	MH2269	November 4, 1998	Minor	7	1	338'-8"	0	0	0'	Pipe nearing capacity.
Location: See Figure 5-2D. S 14th St from S 15th St and north on S 14th St toward Shattuck Ave S.											

**Table 5-2
Capacity Analysis for 2012 Sewer Model - Problem Areas**

Problem Area	Manhole No.		Storm Event	Rating	Mini Basin	Pipe Sections	Length and Diameter	Manhole Surge (hrs)	Manhole Overtopping (hrs)	Max Surge Height (ft)	Comments
	Upstream	Downstream									
11A	MH3522	MH5360	February 8, 1996	Minor	11	1	180'-12"	5	0	0.5'	Capacity issues due to pipe size, backwater due to bend at MH5360.
	MH1903	MH2170	February 8, 1996	Moderate	11	3	892'-12"	8	0	2'	Capacity issues due to pipe size, backwater due to multiple bends.
Location: See Figure 5-2E. S 5th St between Wells Ave S and Main Ave S, from S Grady Way across Williams Ave S to Burnett Ave S.											
11B	MH1940	MH1939	February 8, 1996	Minor/ Moderate	11	1	249'-10"	8	0	1.5'	Pipes nearing/slightly over capacity. Surcharging due to capacity problems in DS system.
Location: See Figure 5-2E. Williams Ave S north of S Grady Way and south of S 5th St.											
14A	MH2183	MH0066	February 8, 1996	Severe	14	5	1284'-12"	27	0	4'	Minor capacity issues due to pipe size and slope, bends. Severe surcharging from capacity problems in DS system.
Location: See Figure 5-2F. Off-road easement from the intersection of Rainier Ave S, SW Sunset Blvd, and S 3rd St and north through private property and along S 2nd St.											

**Table 5-2
Capacity Analysis for 2012 Sewer Model - Problem Areas**

Problem Area	Manhole No.		Storm Event	Rating	Mini Basin	Pipe Sections	Length and Diameter	Manhole Surge (hrs)	Manhole Overtopping (hrs)	Max Surge Height (ft)	Comments
	Upstream	Downstream									
15A	MH2115	KC2790	February 8, 1996	Minor/ Severe	15	6	1252'-15"	16	0	2.5'	Minor capacity issues due to pipe size and bends. Severe surcharging from capacity problems in DS East Side Interceptor.
Location: See Figure 5-2F. S Tobin Street from Shattuck Ave S to Logan Ave S.											
15B	MH5330	MH2115	February 8, 1996	Minor/ Severe	15	5	926'-15"	34	0	3'	Pipe nearing capacity. Severe surcharging from capacity problems in DS Renton sewer and East Side Interceptor.
Location: See Figure 5-2F. Off-road easement from S Tobin St to S 2nd St.											
15C	MH5209	MH2147	February 8, 1996	Minor	15	3	656'-8"	0	0	0'	Negligible capacity issues due to pipe size.
Location: See Figure 5-2F. Easement along S 2nd St between Rainier Ave S and Shattuck Ave.											
16A	MH5398	MH5395	February 8, 1996	Minor	16	2	340'-8"	16	0	2'	Pipe nearing capacity. Backwater due to capacity issues in DS system.
	MH5395	MH2111	February 8, 1996	Severe	16	1	417'-8"	16	0	2'	Capacity issues due to pipe size.

**Table 5-2
Capacity Analysis for 2012 Sewer Model - Problem Areas**

Problem Area	Manhole No.		Storm Event	Rating	Mini Basin	Pipe Sections	Length and Diameter	Manhole Surge (hrs)	Manhole Overtopping (hrs)	Max Surge Height (ft)	Comments
	Upstream	Downstream									
Location: See Figure 5-2F. Renton Ave Ext from Hayes PI SW to Rainier Ave S, Rainier Ave S from Renton Ave Ext/Airport Way to S Tobin St.											
21A	MH3547	MH3582	November 24, 1990	Minor	21	5	1141'-8"	0	0	0'	Pipe nearing capacity.
	NH3582	MH3587	November 24, 1990	Minor/ Severe	21	5	890'-8"	8	0	3'	Pipe nearing capacity. Surcharging due to capacity problems in DS system.
Location: See Figure 5-2G. Anacortes Ave NE from NE 23rd Ct to NE 17th St.											
21B	MH3587	MH5504	November 24, 1990	Moderate	21	3	518'-8"	9	0	3'	Capacity issues due to pipe size.
Location: See Figure 5-2G. NE 17th St east of Anacortes Ave NE.											
22A	MH3614	MH3615	November 24, 1990	Minor	22	1	118'-12"	0	0	0'	Pipe nearing capacity for short duration. No surcharging.
	MH3622	MH3624	November 24, 1990	Minor	22	1	172'-12"	0	0	0'	Pipe at capacity for short duration. No surcharging.
Location: See Figure 5-2G. NE Sunset Blvd from unnamed Access Road east toward Duvall Ave NE.											
23A	MH3498	MH3497	January 9, 1990	Severe	23	1	400'-8"	Entire run	0	0-6.5'	Capacity issues due to pipe size. Surge is intermittent over entire run. Typically 0'-2.5'; Peak surge for 7 hours.

**Table 5-2
Capacity Analysis for 2012 Sewer Model - Problem Areas**

Problem Area	Manhole No.		Storm Event	Rating	Mini Basin	Pipe Sections	Length and Diameter	Manhole Surge (hrs)	Manhole Overtopping (hrs)	Max Surge Height (ft)	Comments
	Upstream	Downstream									
Location: See Figure 5-2H. N 28th Pl between Burnett Ave N and Meadow Ave N.											
23B	MH0495	MH0383	January 9, 1990	Moderate	23	2	49'-8", 251'-12"	115	0	1'	Capacity issues due to pipe size. Surge is intermittent over entire run. Typically 0'-1'. Peak surge for 6 hours.
Location: See Figure 5-2H. Lake Washington Blvd N between Burnett Ave N and N 20th St.											
25A	MH1177	MH1158	November 24, 1990	Severe	25,46	5	315'-10", 651'-12"	8	3	3'	Moderate capacity issues due to pipe size, backwater due to sharp bend at MH1773, MH1772. Severe surcharging from capacity problems in DS system.
Location: See Figure 5-2I. Off-road easement north of SE 5th St between Newport Ave SE and Pierce Ave SE, Pierce Ave SE from SE 5th St to SE 6th St.											
25B	MH1172	MH1175	November 24, 1990	Moderate	25	3	653'-10"	12	0	2'	Capacity issues due to pipe size, backwater due to sharp bend at MH1174.
Location: See Figure 5-2I. Off-road easement south of Sunnysdale Mobile Home Park Access Rd west of Union Ave SE.											
25C	MH1660	MH1663	November 24, 1990	Minor	25	3	1285'-10"	12	0	0	Pipe nearing capacity.
	MH1651	MH1650	November 24, 1990	Minor	25	1	310'-10"	12	0	0	Pipe nearing capacity.

**Table 5-2
Capacity Analysis for 2012 Sewer Model - Problem Areas**

Problem Area	Manhole No.		Storm Event	Rating	Mini Basin	Pipe Sections	Length and Diameter	Manhole Surcharge (hrs)	Manhole Overtopping (hrs)	Max Surcharge Height (ft)	Comments
	Upstream	Downstream									
Location: See Figure 5-2I. SE 4th St from Chelan Ave SE to Union Ave SE, south on Union Ave SE from SE 4th St.											
25D	MH1695	MH1673	November 24, 1990	Minor	25	2	475'-8"	2	0	0.5	Pipe nearing capacity. Surcharging due to bend at MH 1672, capacity issues in DS system.
	MH1672	MH1660	November 24, 1990	Minor	25	2	506'-8"	9	0	0.6'	Capacity issues due to pipe size, backwater due to sharp bends at MH1660.
Location: See Figure 5-2I. From Bremerton Ave SE through easement to SE 2nd PI north of SE 3rd PI.											
26A	MH1506	MH1741	November 24, 1990	Minor	26	7	78'-8", 1322'-12"	0	0	0	Pipe nearing capacity.
Location: See Figure 5-2J. Duvall Ave NE from NE 4th St to NE 6th St.											
27A	MH1114	MH1112	February 8, 1996	Minor	27	2	594'-8"	0	0	0	Pipes at capacity for short duration. Negligible surcharging.
	MH1107	MH1102	February 8, 1996	Minor	27	1	307'-8"	0	0	0	Pipe at capacity for short duration. Negligible surcharging.
Location: See Figure 5-2K. NE 7th PI from NE 6th PI to Monroe Ave NE, off-road easement from NE 6th PI to Jefferson Ave NE.											
28A	MH5350	MH2548	February 8, 1996	Minor	28	1	301'-15"	0	0	0	Pipe nearing capacity.

**Table 5-2
Capacity Analysis for 2012 Sewer Model - Problem Areas**

Problem Area	Manhole No.		Storm Event	Rating	Mini Basin	Pipe Sections	Length and Diameter	Manhole Surcharge (hrs)	Manhole Overtopping (hrs)	Max Surcharge Height (ft)	Comments
	Upstream	Downstream									
	MH2537	MH2536	February 8, 1996	Minor	28	1	281'-18"	0	0	0	Pipe nearing capacity.
Location: See Figure 5-2L. Lind Ave SW between SW 19th St and SW 16th St, SW 16th St from Lind Ave SW toward Seneca Ave SW.											
33A	MH0518	MH0394	January 9, 1990	Minor	33	1	87'-8"	0	0	0	Pipe at capacity for short duration.
Location: See Figure 5-2H. Easement parallel to I-405 and Jones Ave NE south of NE 28th St.											
36A	MH0805	MH0812	February 8, 1996	Moderate/ Severe	36	3	696'-8"	9	0	4'	Moderate capacity issues due to pipe size.
	MH0813	MH0467	February 8, 1996	Moderate	36	2	377'-8"	7	0	4'	Minor capacity issues due to pipe size. Severe surcharging from capacity problems in DS system.
Location: See Figure 5-2M. Harrington Ave NE from NE 12th St to NE Sunset Blvd.											
36B	MH6006	MH0909	February 8, 1996	Moderate	36	1	388'-8"	1	0	0	Minor capacity issues due to pipe size. Negligible surcharging.
Location: See Figure 5-2M. Kirkland Ave NE north of NE 12th St.											
38A-1	MH0467	MH0470	February 8, 1996	Moderate	38	4	287'-8"	17	0	3'	Capacity issues due to pipe size.
Location: See Figure 5-2M. Harrington Ave NE between Glennwood Ave NE and Sunset Blvd NE.											

**Table 5-2
Capacity Analysis for 2012 Sewer Model - Problem Areas**

Problem Area	Manhole No.		Storm Event	Rating	Mini Basin	Pipe Sections	Length and Diameter	Manhole Surge (hrs)	Manhole Overtopping (hrs)	Max Surge Height (ft)	Comments
	Upstream	Downstream									
39A	MH6043	MH0826	February 8, 1996	Minor /Severe	37,39	4	512'-8"	4	0	2.5'	Pipe nearing capacity. Backwater due to capacity issues in DS system.
	MH0826	MH0825	February 8, 1996	Moderate	39		299'-8"	36	0	3'	Capacity issues due to pipe size.
Location: See Figure 5-2M. Edmonds Ave NE from NE 9th St and north toward Sunset Blvd NE.											
41A	MH3327	MH3510	February 8, 1996	Severe	41	6	727'-8", 328'-10"	9	2	5'	Minor to severe capacity issues due to pipe size.
Location: See Figure 5-2N. Lake Washington Blvd N between N 33rd Pl and N 37th St.											
45A	MH2257	MH2252	November 4, 1998	Minor	45	5	1532'-18"	1	0	1'	Capacity issues due to pipe size.
Location: See Figure 5-2D. Off-road easement between S Renton Village Pl to S Grady Way.											
46A	MH1158	RE*CEDAR2.R10-26A	November 24, 1990	Moderate	46	14	2620'-15"	10	0	1.5'	Pipe nearing capacity, surcharging in DS portion do to water levels in Cedar River Trunk, backwater due to multiple bends.
Location: See Figure 5-2O. SE 6th St between SE 5th St and Pierce Ave SE.											

**Table 5-2
Capacity Analysis for 2012 Sewer Model - Problem Areas**

Problem Area	Manhole No.		Storm Event	Rating	Mini Basin	Pipe Sections	Length and Diameter	Manhole Surcharge (hrs)	Manhole Overtopping (hrs)	Max Surcharge Height (ft)	Comments
	Upstream	Downstream									
47A	MH4692	RE*CEDAR1.R10-05A	November 24, 1990	Minor	47	8	155'-12". 660'-22", 760'-24"	36	0	1	Pipe nearing capacity. Surcharging from capacity problems in DS Cedar River Trunk.
Location: See Figure 5-2P. N 4th St west of I-405.											
47B	MH0639	MH0627	November 24, 1990	Moderate/ Severe	47	4	129'-6", 459'-8"	11	4	7	Capacity issues due to pipe size.
Location: See Figure 5-2P. Bronson Way NE between Grandley Way NE and Windsor Way NE.											
47C	MH1976	MH1975	November 24, 1990	Minor	47	1	310'-8"	6	0	0.5	Minor capacity issues due to pipe size.
Location: See Figure 5-2P. NE 4th St between Brighton Ridge Apartments Access Rd and Edmonds Ave SE.											
48A	MH0847	MH1360	February 8, 1996	Severe	48	2	360'-8"	162	0	13'	Capacity issues due to pipe size.
Location: See Figure 5-2P. NE 7th St between Ferndale PI NE and Harrington Ave NE.											
50A	MH0418	MH420	February 8, 1996	Minor	50	2	460'-8"	5	0	1'	Capacity issues due to pipe size. Minor surcharging due to capacity problems in DS Bryn Mawr Interceptor.
Location: See Figure 5-2Q. Easement along Cedar River south of N 6th St.											

**Table 5-2
Capacity Analysis for 2012 Sewer Model - Problem Areas**

Problem Area	Manhole No.		Storm Event	Rating	Mini Basin	Pipe Sections	Length and Diameter	Manhole Surge (hrs)	Manhole Overtopping (hrs)	Max Surge Height (ft)	Comments
	Upstream	Downstream									
65A	MH2818	MH2760	January 9, 1990	Minor	4,65	3	517'-24"	Entire run	0	0	Includes upstream flows from SCWSD. Pipe at capacity.
Location: See Figure 5-2A. SE 16th St from Index Ct SE to Index Ave SE.											
65B	MH5300	MH5302	January 9, 1990	Minor/ Severe	65	1	500'-20"	0	0	0	Pipe nearing capacity. Includes upstream flows from SCWSD.
Location: See Figure 5-2A. Off-road easement north of Royal Hills Dr SE and east of Harrington Pl SE.											
ESI1003A	MH1923	MH1921	February 8, 1996	Minor	ESI1003	3	674'-8"	0	0	0	Full pipe for short duration.
Location: See Figure 5-2Q. Wells Alley N from N 1st St to N 3rd St.											
A1	MH0216	KC1735	February 8, 1996	Minor	A	6	837'-15", 70'-16"	7	0	0.5	Minor capacity issues due to pipe slope. Minor surcharging in DS East Side Interceptor.
Location: See Figure 5-2L. Off-road easement between SW Grady Way and I-405 parallel to Oakesdale Ave SW.											
A2	MH6188	MH6191	February 8, 1996	Minor	A	3	1175'-8"	2	0	0.5'	Minor capacity issues due to pipe size. Surcharging due to bend at MH6190.
Location: See Figure 5-2R. Off-road easement between Oakesdale Ave SW and SW 39th St.											

**Table 5-2
Capacity Analysis for 2012 Sewer Model - Problem Areas**

Problem Area	Manhole No.		Storm Event	Rating	Mini Basin	Pipe Sections	Length and Diameter	Manhole Surge (hrs)	Manhole Overtopping (hrs)	Max Surge Height (ft)	Comments
	Upstream	Downstream									
A3	MH0275	MH0286	February 8, 1996	Severe	A	13	396'-8", 2000'-10"	32	5	11'	Severe capacity issues due to pipe size. Minor surcharging due to capacity problems in DS South Interceptor.
Location: See Figure 5-2R. Off-road easement between Oakdale Ave SW and Interurban Trail north of S 180th St.											
B1	MH5190	MH2982	February 8, 1996	Minor/Moderate	B	2	489'-8"	3	0	0.5	Minor capacity issues due to pipe size.
Location: See Figure 5-2R. SW 34th St from Lind Ave SW to East Valley Road.											
B2	MH3173	RE*SRENTON.R18-05	February 8, 1996	Minor	B	2	245'-8"	1	0	0	Minor capacity issues due to pipe size. Negligible surcharging.
Location: See Figure 5-2R. 84th Ave S from SW 43rd St towards SW 41st St.											
U6A	MH4717	MH4713	N/A	Minor	U6	3	587'-8"	Intermittent entire run	0	0	Negligible intermittent surcharging due to LS 34 (Liberty). Model contains constant flow rate inputs for U-Basins.
Location: See Figure 5-2S. SE 137th Terrace from 160th Ave SE to 161st PI SE, 161st PI SE south from SE 137th Terrace.											

ULTIMATE MODEL PEAK FLOW AND CAPACITY ANALYSIS

Peak Storm

The peak storm rainfall events assigned to the 2012 Model were assigned to the Ultimate model using the same methodology.

The County did not conduct hydraulic modeling for its future development scenarios. Instead, it determined the 20-year peak flows for locations within its sewer system, and applied a growth factor to determine to 20-year peak flows at 10-year intervals. So to use the boundary time series developed for the 2012 analysis for the external boundary flows, the flow rates were multiplied by a factor based on a ratio of the County's 2010 and 2060 20-year peak flow rates. As with the 2012 model, 20-year constant peak flow rates were assigned at the other locations. This conservative assumption contributed to surcharging and capacity issues in portions of the system.

Analysis Results

Table 5-3 summarizes the peak flow at the outlet from each mini-basin and the corresponding storm events from the 2012 and Ultimate Model analysis. For some of the mini-basins, the peak flow from the 2012 Model exceeds the peak flow from the Ultimate Model, or does not significantly increase for the Ultimate Model. In some of these cases, changes in the sewer system or assumptions rerouted or decreased flow to certain mini-basins.

Table 5-3
City of Renton Sewer Model - 2012 and Ultimate Peak Flow at Mini-Basin Outlet, Including Storm Event

Mini-Basin	Outlet MH#	2012 Peak Flow		Ultimate Peak Flow		Storm Event Used
		(cfs)	(gpm)	(cfs)	(gpm)	
1	MH2493 (5319095)	0.62	278	0.91	408	November 4, 1998
2	MH2481 (5319084)	1.03	462	2.53	1,135	November 4, 1998
3	MH2323 (5320049)	1.73	776	1.01**	453**	November 4, 1998
4	MH2814 (5321024)	8.81*	3,954*	18.72*	8,402*	January 9, 1990
5	RE*SRENTON.R18-15	8.26*	3,707*	10.48*	4,703*	November 24, 1990
6	MH2999 (5330059)	1.54	691	1.69	758	November 24, 1990
7	MH2257 (5319035) ¹	3.39	1,521	5.77	2,590	November 4, 1998
8	MH0169 (4324017)	0.70	314	1.48	664	February 8, 1996
9	MH0167 (4324012)	1.40	628	1.72	772	February 8, 1996
10	MH2161 (5318106)	0.37	166	0.42	189	February 8, 1996
11	RE*ESI1.RO1-14	3.83	1,719	5.02	2,253	February 8, 1996
12	MH2440 (5318226)	0.45	202	0.53	238	February 8, 1996
13	MH2247 (5319020)	2.12	951	2.36	1,059	February 8, 1996
14	MH2373 (5318148)	1.94	871	2.17	938	February 8, 1996
15	MH2118 (5318047)	4.41	1,979	4.89	2,195	February 8, 1996
16	MH2113(5318042)	1.16	521	1.39	624	February 8, 1996
17	MH1851 (5317033)	0.34	153	0.41	184	November 24, 1990
18	MH1825 (5317002)	1.52	682	9.03***	4,052***	February 8, 1996
19	MH0246 (4325005)	0.36	162	0.51	229	February 8, 1996
20	MH4301 (5303426)	1.04	467	2.17	974	November 24, 1990
21	MH5503(5303093)	1.01	453	1.44	646	November 24, 1990
22	MH3625 (5303102)	2.60	1,166	4.27	1,916	November 24, 1990
23	MH0383 (5305041)	2.10	943	2.98	1,337	January 9, 1990
24	MH0923 (5309169)	1.38	619	1.53	686	February 8, 1996
25	MH1156 (5316015)	1.99	893	1.12**	502**	November 24, 1990
26	MH1244(5316115)	3.10	1,391	4.02	1,804	November 24, 1990
27	MH1365 (5309478)	0.74	332	0.87	390	February 8, 1996
28	MH0205 (4324060)	1.68	754	2.27	1,018	February 8, 1996
29	MH0448 (5308252)	0.70	314	0.81	363	February 8, 1996
30A	MH4653 (5308327)	3.00	1346	4.80	2,154	February 8, 1996

**Table 5-3
City of Renton Sewer Model - 2012 and Ultimate Peak Flow at Mini-Basin Outlet, Including Storm Event**

Mini-Basin	Outlet MH#	2012 Peak Flow		Ultimate Peak Flow		Storm Event Used
		(cfs)	(gpm)	(cfs)	(gpm)	
30B	MH4651(5308329)	5.98	2,684	8.11	3,640	February 8, 1996
30C	MH0714 (5308161)	3.00	1,346	3.42	1,535	February 8, 1996
32	RE*ESI1.RO1-32A	3.45	1,548	4.00	1,795	February 8, 1996
33	MH0490 (5305008)	1.60	718	2.31	1,037	January 9, 1990
34	MH0362 (5304207)	0.34	152	0.53	237	January 9, 1990
35	MH0368 (5304230)	2.87	1,289	4.64	2,083	November 24, 1990
36	MH0467 (5309128)	1.29	579	1.52	682	February 8, 1996
37	MH6044 (5309028)	0.82	368	1.01	453	February 8, 1996
38A	MH0472 (5309133)	1.57	705	1.86	834	February 8, 1996
38B	MH0371 (5304234)	2.46	1,104	4.06	1,822	February 8, 1996
39	MH6074 (5308236)	3.06	1,373	3.66	1,642	February 8, 1996
40	RE*ESI4.RO2-19	0.53	238	0.77	346	February 8, 1996
41	MH3511 (5432141)	1.12	503	1.53	687	February 8, 1996
42	MH3386 (5432004)	1.20*	539*	4.86*	2,181*	January 9, 1990
43	MH1206 (5316068)	0.31	139	0.47	211	November 24, 1990
44	MH1264 (5316136)	3.22	1,445	4.34	1,948	November 24, 1990
45	MH2253 (5319027)	5.38	2,414	7.09	3,182	November 4, 1998
46	RE*CEDAR1.R10-11A	31.98*	14,354*	47.54*	21,337*	November 24, 1990
47	MH2014 (5317243)/ MH1966 (5317183)	9.20	4,129	12.13	5,444	November 24, 1990
48	MH6075 (5308059)	2.22	996	2.38	1,068	February 8, 1996
49	MH0196 (4324044)	0.41	184	0.54	242	February 8, 1996
50	RE*BRYNMAWR.RO1-57	15.86*	7,118*	27.39*	12,293*	February 8, 1996
52	MH5833 (5308169)	0.39	175	0.50	224	February 8, 1996
54	RE*ESI2.RO2-08	209.70*	94,120*	239.6*	107,540*	February 8, 1996
65	MH5302 (5321007)	14.47*	6,495*	19.07*	8,559*	January 9, 1990

*Includes upstream flows from adjacent sewer purveyor

**Decrease in peak flow rates from 2012 to Ultimate Analysis due to future sewer diversion projects described in Chapter 2.

***Large increase in peak flows at Mini-Basin 18 outlet to overflow at MH1966 from Mini-Basin 47.

Figure 5-3 identifies pipes color-coded by the ratios of peak flow rates to maximum pipe capacities (Q/Q_{Full}) for the ultimate analysis, consistent with the methodology and format used for the 2012 Model analysis. Where possible, the same exact problem area labels were used from the 2012 Model analysis, with additional problem areas identified within each mini-basin as needed. Only City piping was identified in the problem areas; areas where County piping exceeded a Q-ratio of 0.8 were not labeled. The problem areas were summarized and classified in Table 5-4 based on the degree of surcharging. This table includes a location description, the duration of surcharging above the crown of the pipe (where applicable), the duration of surcharging above manhole rims (where applicable), a brief listing of the suspected cause of the problem or any special conditions for severe problems, and a ranking of the severity of each problem. Figures 5-3A to 5-3S, which are referenced in the Table, are included in Appendix D. Blow-ups of the problem areas are shown in Figure 5-3.

Surcharging problems in the system are generally the result of insufficient capacity in the City's pipes, compounded by backwater from the County's trunk lines in some instances. There are several connections in Mini-Basins A and B where sections of the City's pipe are modeled below the hydraulic grade line of the County system. These problem areas in Mini-Basins A and B could potentially be related to the vertical datum assumptions.

Assigning the constant peak inflows for the boundary flows was conservative, as mentioned above. The constant inflows caused the discharge in some of the mini-basins to look non-standard, including Mini-Basins 4, 42, 46, and 65. For each of these mini-basins, the incoming constant peak boundary flow dominates the local flows, such that the peaks caused by the individual mini-basins do not appear to contribute as significantly to the total flow as may appear at some of the other mini-basins. Additionally, Mini-Basin 50 has severe surcharging issues in the King County trunk sewer, which significantly influences flows in the downstream system.

**Table 5-4
Capacity Analysis for Ultimate Sewer Model - Problem Areas**

Problem Area	Manhole No.		Storm Event	Rating	Mini	Pipe	Length and Diameter	Manhole	Manhole	Max Surcharge	Comments
	Upstream	Downstream			Basin	Sections		Surcharge (hrs)	Overtopping (hrs)	Height (ft)	
03A	MH2367	MH2364	November 4, 1998	Minor	3	3	716'-8"	0	0	0	Pipe nearing capacity
Location: See Figure 5-3A. SE 19th St from Rolling Hills Ave SE to Aberdeen PI SE.											
04A	MH2795	MH2819	January 9, 1990	Severe	4	8	2222'-24"	Entire run	0	17'	Includes upstream flows from SCWSD. Capacity issues due to pipe size.
Location: See Figure 5-3B. Index Ct SE south of SE 16th St, off-road easement from Index Ct SE to Kirkland Ave SE and to Beacon Way ROW.											
05A	MH2999	RE*SRENT.R18-19	November 24, 1990	Severe	5	4	921'-8"	17	14	6'	Capacity issues due to pipe size, backwater due to sharp bend at MH2996, MH2997
Location: See Figure 5-3C. Off-road easement parallel to Shattuck Ave S north of S 37th St.											
05B	MH3218	RE*SRENT.R18-25	November 24, 1990	Severe	5	3	960'-8"	6	0	5'	Capacity issues due to pipe size
Location: See Figure 5-3C. Talbot Road S from S 177th St to S Carr Rd/S 43rd St.											
05C	MH3198	MH5523	November 24, 1990	Severe	5	9	1645'-8"	9	0	10'	Capacity issues due to pipe size, backwater due to sharp bend at MH3193, MH3194
	MH5519	RE*SRENT.R18-17	November 24, 1990	Severe	5	3	902'-12"	11	0	8'	Capacity issues due to pipe size. Severe surcharging due to backwater in South Renton Interceptor
Location: See Figure 5-3C. Davis Ave S south of S 43rd St.											
5D	MH3205	MH3198	November 24, 1990	Minor/ Severe	5	2	474'-8"	8	0	9'	Pipe nearing capacity. Severe surcharging due to backwater in DS system
Location: See Figure 5-3C. Off-road easement south of Davis Ave S along Copper Ridge Apt Access Rd.											

**Table 5-4
Capacity Analysis for Ultimate Sewer Model - Problem Areas**

Problem Area	Manhole No.		Storm Event	Rating	Mini	Pipe	Length and Diameter	Manhole	Manhole	Max Surcharge	Comments
	Upstream	Downstream			Basin	Sections		Surcharge (hrs)	Overtopping (hrs)	Height (ft)	
06A	MH3017	MH3004	November 24, 1990	Severe	6	8	2604'-8"	13	6	9'	Capacity issues due to pipe size, backwater due to sharp bend at MH3004, MH3009
Location: See Figure 5-3D. Talbot Rd S between S 27th Pl and S 32nd St, Off-road easement parallel to Talbot Road S.											
07C	MH2275	Prop. Talbot Hill MH	November 4, 1998	Minor	7	6	1593'-8"	0	0	0.5'	Pipe sections nearing or at capacity. Negligible surcharging
Location: See Figure 5-3E. Lake Ave S between S 14th St and S 19th St.											
9A	MH0166	MH0167	February 8, 1996	Minor/ Moderate	9	1	390'-12"	75	0	2'	Pipe nearing capacity. Surcharging due to backwater from DS Eastside Interceptor
Location: See Figure 5-3F. Black River Trail parallel to Oakdale Ave SW north of SW Grady Way.											
11A	MH1910	MH2170	February 8, 1996	Severe	11	8	1720'-12"	50	9	5.5'	Capacity issues due to pipe size, backwater due to multiple bends.
Location: See Figure 5-3G. S 5th St from Main Ave S to Wells Ave S, Wells Ave S between S 5th St and S Grady Way, off-road easement from Wells Ave S across Williams Ave S to Burnett Ave S.											
11B	MH1941	MH1939	February 8, 1996	Moderate/ Severe	11	2	531'-10"	50	9	6'	Capacity issues due to pipe size, severe surcharging in DS system
Location: See Figure 5-3G. Williams Ave S between S 5th St and S Grady Way.											
14A	MH2183	MH0066	February 8, 1996	Moderate/ Severe	14	5	1284'-12"	62	3	11'	Capacity issues due to pipe size, slope, and bends. Severe surcharging from capacity problems in DS system
Location: See Figure 5-3H. Off-road easement from Rainier Ave S and north parallel to S 2nd St.											

**Table 5-4
Capacity Analysis for Ultimate Sewer Model - Problem Areas**

Problem Area	Manhole No.		Storm Event	Rating	Mini	Pipe	Length and Diameter	Manhole	Manhole	Max Surcharge	Comments
	Upstream	Downstream			Basin	Sections		Surcharge (hrs)	Overtopping (hrs)	Height (ft)	
15A	MH2115	KC2790	February 8, 1996	Moderate/ Severe	15	6	1252'-15"	66	0	8.5'	Capacity issues due to pipe size and bends. Severe surcharging from capacity problems in DS East Side Interceptor
Location: See Figure 5-3H. S Tobin St between Shattuck Ave S and Burnett Ave S.											
15B	MH5330	MH2115	February 8, 1996	Minor/ Severe	15	5	926'-15"	64	0	9.5'	Pipes nearing/at capacity. Severe surcharging from capacity problems in DS Renton sewer and East Side Interceptor
Location: See Figure 5-3H. Off-road easement following Shattuck Ave S between S Tobin St and S 2nd St.											
15C	MH5209	MH2147	February 8, 1996	Minor/ Severe	15	3	656'-8"	12	0	3'	Capacity issues due to pipe size. Severe surcharging from capacity problems in DS Renton sewer and East Side Interceptor
Location: See Figure 5-3H. S 2nd St between Rainier Ave S and Shattuck Ave S.											
16A	MH5398	MH2111	February 8, 1996	Severe	16	3	756'-8"	18	0	4'	Capacity issues due to pipe size
Location See Figure 5-3H. Renton Ave Ext from Hayes Pl SW to Rainier Ave S, Rainier Ave S from Renton Ave Ext/Airport Way to S Tobin St.											
18A	MH1966	MH1826	February 8, 1996	Minor	18	8	2039'-22"	5	0	1'	Pipes nearing/over capacity.
Location: See Figure 5-3I. N 4th St from Burnett Ave N to Factory Ave N.											
20A	MH3728	MH5270	November 24, 1990	Minor	20	1	403'-8"	0	0	0	Pipe nearing capacity.
Location: See Figure 5-3J. Lyons Ave NE between NE 26th St and 148th Ave SE.											

**Table 5-4
Capacity Analysis for Ultimate Sewer Model - Problem Areas**

Problem Area	Manhole No.		Storm Event	Rating	Mini	Pipe	Length and Diameter	Manhole	Manhole	Max Surcharge	Comments
	Upstream	Downstream			Basin	Sections		Surcharge (hrs)	Overtopping (hrs)	Height (ft)	
21A	MH3547	MH3582	November 24, 1990	Minor/Severe	21	5	1141'-8"	7	0	3'	Pipe nearing capacity. Surcharging due to capacity problems in DS system.
	MH3582	MH3587	November 24, 1990	Minor/Severe	21	5	758'-8"	30	0	6'	Pipe nearing/at capacity. Surcharging due to capacity problems in DS system.
Location: See Figure 5-3K. Anacortes Ave NE between NE 22nd Ct and NE 17th St.											
21B	MH3587	MH5504	November 24, 1990	Severe	21	3	518'-8"	30	0	6'	Capacity issues due to pipe size
Location: See Figure 5-3K. NE 17th St between Anacortes Ave NE and Duvall Ave NE.											
22A	MH3614	MH3624	November 24, 1990	Severe	22	6	963'-12"	13	0	6'	Capacity issues due to pipe size
	MH3624	MH3626	November 24, 1990	Minor	22,35	2	255'-15"	3	0	0	Pipe over capacity for short duration. Negligible surcharging.
Location: See Figure 5-3K. NE Sunset Blvd from Anacortes Ave NE to Union Ave NE.											
23A	MH0490	MH3500	January 9, 1990	Minor	23	6	842'-12"	4	0	1'	Minor capacity issues due to pipe size
	MH3499	MH3497	January 9, 1990	Severe	23	2	701'-8"	Entire run	0	0'-17'	Capacity issues due to pipe size. Surcharge is intermittent over entire run. Typically 0'-8'. Peak surcharge for 7 hours
Location: See Figure 5-3L. N 28th Pl east of Burnett Ave N to Park Ave N, N 28th St from Park Ave N to I-405.											
23B	MH0495	MH0383	January 9, 1990	Moderate	23	2	49'-8", 251'-12"	Entire run	0	2'	Capacity issues due to pipe size. Surcharge is intermittent over entire run. Typically 0'-1'. Peak surcharge for 6 hours

**Table 5-4
Capacity Analysis for Ultimate Sewer Model - Problem Areas**

Problem Area	Manhole No.		Storm Event	Rating	Mini	Pipe	Length and Diameter	Manhole	Manhole	Max Surcharge	Comments
	Upstream	Downstream			Basin	Sections		Surcharge (hrs)	Overtopping (hrs)	Height (ft)	
Location: See Figure 5-3L. Lake Washington Blvd N between Burnett Ave N and N 20th St.											
25A	MH1177	MH1158	November 24, 1990	Minor/ Severe	25,46	5	315'-10", 651'-12"	66	38	5'	Pipes near/slightly over capacity. Backwater due to sharp bend at MH1773, MH1772. Severe surcharging from capacity problems in DS system
Location: See Figure 5-3M. Off-road easement north of SE 5th St between Newport Ave SE and Pierce Ave SE, Pierce Ave SE from SE 5th St to SE 6th St.											
25B	MH1173	MH1174	November 24, 1990	Minor	25	1	323'-10"	3	0	0.5'	Minor capacity issues due to pipe size, backwater due to sharp bend at MH1174
Location: See Figure 5-3M. Off-road easement south of Sunnydale Mobile Home Park Access Rd west of Union Ave SE.											
25C	MH1660	MH1650	November 24, 1990	Minor	25	6	2116'-10"	2	0	0	Pipe nearing/at capacity. Negligible surcharging
Location: See Figure 5-3M. SE 4th St from Chelan Ave SE to Union Ave SE, south on Union Ave SE from SE 4th St.											
25D	MH1695	MH1660	November 24, 1990	Moderate	25	5	1211'-8"	8	0	2'	Capacity issues due to pipe size, backwater due to sharp bends at MH1660
Location: See Figure 5-3M. From Bremerton Ave SE through easement to SE 2nd PI north of SE 3rd PI.											
25E	MH1706	MH1695	November 24, 1990	Minor/ Moderate	25	5	487'-8"	8	0	2'	Pipes nearing capacity. Surcharging from capacity problems in DS system
Location: See Figure 5-3M. Bremerton Ave SE from 135th Ave SE to Bremerton PI NE, Bremerton PI NE from Bremerton Ave SE to NE 1st PI.											
26A	MH1437	MH1741	November 24, 1990	Minor	26	5	991'-12"	1	0	0	Pipes nearing/slightly over capacity. Negligible surcharging
Location: See Figure 5-3N. Duvall Ave NE from NE 6th St to NE 4th St.											

**Table 5-4
Capacity Analysis for Ultimate Sewer Model - Problem Areas**

Problem Area	Manhole No.		Storm Event	Rating	Mini	Pipe	Length and Diameter	Manhole	Manhole	Max Surcharge	Comments
	Upstream	Downstream			Basin	Sections		Surcharge (hrs)	Overtopping (hrs)	Height (ft)	
27A	MH0976	MH1112	February 8, 1996	Minor	27	3	825'-8"	3	0	0.5'	Pipes nearing/slightly over capacity.
	MH1107	MH1365	February 8, 1996	Minor	27	2	569'-8"	4	0	0.5'	Pipes nearing/slightly over capacity.
Location: See Figure 5-3O. NE 7th Pl from NE 6th Pl to Monroe Ave NE, off-road easement from NE 7th St to Jefferson Ave NE.											
28A	MH5350	MH2548	February 8, 1996	Minor	28	1	301'-15"	0	0	0	Pipe nearing capacity.
	MH2537	MH2536	February 8, 1996	Minor	28	1	281'-18"	0	0	0	Pipe nearing capacity.
Location: See Figure 5-3P. Lind Ave SW between SW 19th St and SW 16th St, SW 16th St from Lind Ave SW to Raymond Ave SW.											
32A	MH0445	MH0726	February 8, 1996	Minor/Severe	32	1	286'-24"	52	0	2.5'	Pipes nearing capacity. Surcharging from capacity problems in DS East Side Interceptor
Location: See Figure 5-3I. N 6th St between Park Ave N and Garden Ave N.											
33A	MH0518	MH0519	January 9, 1990	Minor	33	2	213'-8"	2	0	0	Pipes nearing/slightly over capacity. Negligible surcharging
Location: See Figure 5-3L. Off-road easement parallel to I-405.											
36A	MH0805	MH0467	February 8, 1996	Severe	36	6	1314'-8"	8	0	7'	Capacity issues due to pipe size. Surcharging from capacity problems in DS system
Location: See Figure 5-3Q. Harrington Ave NE from NE 12th St to NE Sunset Blvd.											
36B	MH6006	MH0907	February 8, 1996	Minor	36	3	983'-8"	1	0	1'	Minor capacity issues due to pipe size. Surcharging from capacity problems in DS system
Location: See Figure 5-3Q. NE 12th St from Harrington Ave NE to NE Sunset Blvd, Kirkland Ave NE from NE 12th St to NE 13th St.											

**Table 5-4
Capacity Analysis for Ultimate Sewer Model - Problem Areas**

Problem Area	Manhole No.		Storm Event	Rating	Mini	Pipe	Length and Diameter	Manhole	Manhole	Max Surcharge	Comments
	Upstream	Downstream			Basin	Sections		Surcharge (hrs)	Overtopping (hrs)	Height (ft)	
38A-1	MH0467	MH0470	February 8, 1996	Moderate	38	4	287'-8"	22	0	3'	Capacity issues due to pipe size
Location: See Figure 5-3Q.											
39A	MH6042	MH0825	February 8, 1996	Severe	37,39	6	1130'-8"	4	0	4'	Capacity issues due to pipe size.
Location: See Figure 5-3Q. Edmonds Ave NE from NE Sunset Blvd to NE 9th St.											
41A	MH3329	MH3510	February 8, 1996	Severe	41	8	1035'-8", 328'-10"	66	60	8'	Capacity issues due to pipe size. Severe surcharging from capacity problems in DS East Side Interceptor
Location: See Figure 5-3R. Lake Washington Blvd N from N 33rd St to N 36th St.											
45A	MH2257	MH2252	November 4, 1998	Moderate	45	5	1532'-18"	2	0	2'	Capacity issues due to pipe size
Location: See Figure 5-3E. Off-road easement from S Grady Way to S Renton Village Pl.											
46A	MH1158	RE*CEDAR2.R10-26A	November 24, 1990	Minor/ Severe	46	14	2620'-15"	10	0	1.5	Severe surcharging in DS portion due to water levels in Cedar River Trunk. No capacity problems in pipe.
Location: See Figure 5-3S. SE 6th St between SE 5th St and Pierce Ave SE.											
47A	MH4692	RE*CEDAR1.R10-05A	November 24, 1990	Minor/ Severe	47	8	155'-12", 660'-22", 720'-24"	36	0	2.5'	Minor capacity issues due to pipe size. Surcharging from capacity problems in DS Cedar River Trunk
Location: See Figure 5-3T. N 4th St west of Houser Way N.											
47B	MH0622	MH0639	November 24, 1990	Minor/ Severe	47	2	394'-8"	18	0	2'	Pipe nearing capacity. Surcharging from capacity problems in DS system

**Table 5-4
Capacity Analysis for Ultimate Sewer Model - Problem Areas**

Problem Area	Manhole No.		Storm Event	Rating	Mini	Pipe	Length and Diameter	Manhole	Manhole	Max Surge	Comments
	Upstream	Downstream			Basin	Sections		Surcharge (hrs)	Overtopping (hrs)	Height (ft)	
	MH0639	MH0627	November 24, 1990	Severe	47	4	129'-6", 429'-8"	13	10	7'	Capacity issues due to pipe size
Location: See Figure 5-3T. Bronson Way NE from Grandley Way NE to Windsor Way NE.											
47C	MH1976	MH1975	November 24, 1990	Minor	47	1	311'-8"	8	0	1	Capacity issues due to pipe size
Location: See Figure 5-3T. NE 4th St west of Edmonds Ave NE.											
47D	MH1851	MH1968	November 24, 1990	Minor/ Severe	47	1	469'-15"	55	0	3'	Pipe nearing capacity. Surcharging from capacity problems in DS system
Location: See Figure 5-3T. Houser Way N between Factory PI N and N 4th St.											
47E	MH4645	MH4644	November 24, 1990	Minor	47	1	100'-15"	0	0	0	Pipe nearing capacity.
Location: See Figure 5-3T. Sunset Blvd NE between Bronson Way NE and I-405.											
48A	MH0847	MH1360	February 8, 1996	Severe	48	2	360'-8"	Entire run	0	14'	Capacity issues due to pipe size
Location: See Figure 5-3T. NE 7th St between Ferndale PI NE and Harrington Ave NE.											
50A	MH0418	MH420	February 8, 1996	Moderate/ Severe	50	2	460'-8"	67	57	6'	Capacity issues due to pipe size. Severe surcharging due to capacity problems in DS Bryn Mawr Interceptor
Location: See Figure 5-3I. Cedar River Trail south of N 6th St.											
65A	MH2818	MH2760	January 9, 1990	Moderate	4,65	3	517'-24"	Entire run	0	3'	Includes upstream flows from SCWSD. Capacity issues due to pipe size.
	MH5275	MH5299	January 9, 1990	Severe	65	3	432'-18", 322'-20"	Entire run	132	12'	Includes upstream flows from SCWSD. Capacity issues due to pipe size.

**Table 5-4
Capacity Analysis for Ultimate Sewer Model - Problem Areas**

Problem Area	Manhole No.		Storm Event	Rating	Mini	Pipe	Length and Diameter	Manhole	Manhole	Max Surcharge	Comments
	Upstream	Downstream			Basin	Sections		Surcharge (hrs)	Overtopping (hrs)	Height (ft)	
Location: See Figure 5-3B. SE 16th St from Lake Youngs Way SE and north of SE Royal Hills Dr.											
65B	MH5301	MH5303	January 9, 1990	Severe	65	4	134'-15", 1001'-20"	Entire run	Entire run	21'	Capacity issues due to pipe size. Backwater due to bend at MH 5302. Includes upstream flows from SCWSD
Location: See Figure 5-3B. Off-road easement north of Royal Hills Dr SE and east of Harrington Pl SE.											
ESI1003A	MH1923	MH1921	February 8, 1996	Minor/ Severe	ESI1003	3	674'-8"	54	0	3'	Capacity issues due to pipe size. Surcharging due to backwater in East Side Interceptor
Location: See Figure 5-3I. Wells Alley N from N 3rd St to N 1st St.											
ESI1003B	MH4635	RE*ESI2.RO2-01	February 8, 1996	Moderate/ Severe	ESI1003	7	944'-10"	84	82	11.5'	Capacity issues due to pipe size. Severe surcharging due to backwater in East Side Interceptor
Location: See Figure 5-3V. Off-road easement from Lake Washington Blvd N northwest toward Lake Washington.											
ESI1003C	MH0192	RE*ESI2.RO1-03	February 8, 1996	Minor	ESI1003	4	934'-8"	2	0	0.5'	Minor capacity issues due to pipe size
Location: See Figure 5-3F. Thomas Ave SW from SW 7th St to SW 10th St.											
ESI1003D	MH2440	MH2244	February 8, 1996	Minor/ Severe	ESI1003	1	240'-8"	58	0	2'	Minor capacity issues due to pipe size. Surcharging due to backwater in East Side Interceptor
Location: See Figure 5-3F. Hardie Ave SW between SW 5th Pl and SW 7th St.											
A1	MH0216	KC1735	February 8, 1996	Minor/ Moderate	A	6	837'-15", 70'-16"	66	0	2'	Capacity issues due to pipe slope. Surcharging in DS East Side Interceptor
Location: See Figure 5-3F. Off-road easement parallel to Oakesdale Ave SW north of SW Grady Way.											

**Table 5-4
Capacity Analysis for Ultimate Sewer Model - Problem Areas**

Problem Area	Manhole No.		Storm Event	Rating	Mini	Pipe	Length and Diameter	Manhole	Manhole	Max Surcharge	Comments
	Upstream	Downstream			Basin	Sections		Surcharge (hrs)	Overtopping (hrs)	Height (ft)	
A2	MH6188	MH6191	February 8, 1996	Minor/ Severe	A	3	1175'-8"	22	10	5'	Pipes nearing/slightly over capacity. Surcharging due to bend at MH6190 and backwater in DS South Interceptor
Location: See Figure 5-3U. Off-road easement between Oaksdale Ave SW and SW 39th St.											
A3	MH0275	MH0286	February 8, 1996	Severe	A	13	396'-8", 2000'-10"	39	31	12'	Severe capacity issues due to pipe size. Severe surcharging due to capacity problems in DS South Interceptor
Location: See Figure 5-3U. Off-road easement between Oaksdale Ave SW and Interurban Trail north of S 180th St.											
A4	MH0186	RE*ESI2.RO1-04	February 8, 1996	Minor	A	2	275'-8"	2	0	0	Pipe over capacity for short duration. Negligible surcharging.
Location: See Figure 5-3F. SW 10th St from Powell Ave SW towards Thomas Ave SW.											
B1	MH5191	MH2982	February 8, 1996	Minor/ Severe	B	5	1367'-8"	5	0	2.5'	Capacity issues due to pipe size. Additional surcharging due to possible pump capacity issues in Lift Station.
Location: See Figure 5-3U. SW 34th St from Lind Ave SW to E Valley Rd.											
B2	MH3172	RE*SRENTON.R18-05	February 8, 1996	Minor/ Severe	B	3	645'-8"	33	0	8'	Pipe nearing capacity. Severe surcharging from capacity problems in DS South Renton Interceptor
Location: See Figure 5-3U. 84th Ave S from SW 43rd St towards SW 41st St.											

**Table 5-4
Capacity Analysis for Ultimate Sewer Model - Problem Areas**

Problem Area	Manhole No.		Storm Event	Rating	Mini	Pipe	Length and Diameter	Manhole	Manhole	Max Surcharge	Comments
	Upstream	Downstream			Basin	Sections		Surcharge (hrs)	Overtopping (hrs)	Height (ft)	
B3	MH2987	RE*SRENTON.R18-11	February 8, 1996	Minor/ Severe	B	7	2012'-12"	26	7	7'	Pipes nearing/slightly over capacity. Severe surcharging from capacity problems in DS South Renton Interceptor
Location: See Figure 5-3U. East Valley Rd from SW 34th St to SW 41st St,											
U6A	MH4717	MH4713	N/A	Minor	U6	3	587'-8"	Intermittent entire run	0	0.5'	Intermittent surcharging due to LS 34 (Liberty). Model contains constant flow rate inputs for U-Basins
Location: See Figure 5-3W. SE 137th Terrace from 160th Ave SE to 161st PI SE, 161st PI SE south from SE 137th Terrace.											

Based on discussions with Bruce Nairn of King County, the County's interceptor located in Mini-Basin 50 has significant potential surcharging issues, primarily due to severe I&I problems in the upstream County-owned system. Surcharging potential was evident in the 2012 Model Analysis, and significantly more pronounced in the Ultimate Model Analysis. The County plans to install a storage facility to dampen peak flows or implement an I&I repair and reduction program for the upstream system, or both. For the Ultimate Model analysis, it was assumed that this County trunk line would be at capacity (rather than significantly exceeding capacity) during the 20-year design flow-generating event, resulting from the future improvements. As a result of this assumption, the County's trunk sewer would not cause backwater effects in the City's sewer mains within Mini-Basin 50. Further coordination with the County is recommended with regard to the significant future zoning densification projected in the City, adjacent to their trunk sewer, within Mini-Basin 50.

During the Ultimate Model analysis, some lift stations overtopped significantly; to the extent that the model could not complete its computations. These lift stations include East Valley (L04), Airport (L03), Stonegate (L29), and Long (L07). The pumps in each of these cases were upsized to accommodate the peak flow rate with a single pump in operation to allow MIKE URBAN to complete the computations. The Airport and Stonegate pumps were modeled based on projected peak pump capacities with as-designed impeller upgrades. Since most or all of the City's lift stations appear to only contain two duty pumps, any of the duplex stations operating with more than one pump would function beyond their design capacity.

The I&I increase assumption of 7% per decade and a maximum of 28% for the Ultimate Model may be overly conservative for newer portions of the City constructed primarily with PVC and ductile iron pipes. These system degradation assumptions may be reasonable for the older portions of the system. During future analysis, pipe material and age should be taken into consideration in addition to flow monitoring. Also, the degree of I&I reduction efforts by the City should be taken into consideration for flow modeling. It may be more practical to assume lower degradation rates for some of the newer portions of the system. For sewer system located in the "U" Basins, standard I&I assumptions (1500 gallons per day per acre) were used, with no applied degradation. It may be desirable to incorporate some degradation (such as 7%) for the newer system in future analyses.

No flow monitors were associated with Mini-Basin A and a portion of B, which have multiple discharges to KC trunks; there was no check on the accuracy of these flows. The flows were generated from standard sanitary and I&I assumptions rather than subtracted from the South Interceptor. I&I parameters used by KC from an adjacent Model Basin were assigned, which may or may not be representative of actual conditions. Further monitoring and analysis is recommended (see Chapter 6).

Although flows were calibrated to reasonable accuracy based on King County's 2008-2011 flow monitoring data, all of the flows in the Ultimate Model are more heavily based on assumptions and projections, as detailed herein. It is advisable to

conduct additional flow monitoring and analysis to verify the existence and extent of projected problem areas in the City's system.

LIFT STATION AND FORCE MAIN ANALYSIS

A review of lift station and force main capacity was conducted for the 2012 and Ultimate model analysis. In each case, the model results were reviewed to determine the number of pumps operating during the peak storm event, and the maximum velocity of the flow in each force main. Typically, lift stations are designed so that a single pump is able to convey the peak 20-year flow. Flow velocities in the force main should be a maximum of 8 feet per second. Results are shown in Table 5-5.

**Table 5-5
Lift Station and Force Main Analysis Summary**

Lift Station	Mini-Basin	Force Main	2012 Analysis		Ultimate Analysis	
			Max. Pumps On	Max. Force Main Velocity (fps)	Max. Pumps On	Max. Force Main Velocity (fps)
L01-Shy Creek	U4	8" PVC	1	3.5	1	3.5
L02-Devils Elbow	33	6" PVC	1	4.7	1	4.7
L03-Airport	16	5" PVC	1	2.8	1*	4.7
L04-East Valley	B	12" DI	2	1.27	2	1.27
L05-Talbot Crest	6	3" PVC	1	4.3	1	4.3
L07-Long	21	6" PVC	1	0.97	1	0.97
L08-Kensington	65	3" PVC	1	5	1	5
L09-Wedgewood	22	10" DIP	1	1.3	1	1.3
L25-Lind Ave	28	8" PVC	1	4.4	1	4.4
L29-Stone Gate	20	8" PVC	1	1.7	1*	3.4
L30-Falcon Ridge	4	10" PVC	1	1.4	1	1.4
L32-Misty Cove	54	Not Modeled	2	N/A	2	N/A
L34-Liberty	U6	8" PVC	1	3.9	1	3.9
L39-Baxter	54	6" PVC	2	4.8	2	4.8

*Lift stations modeled to include pump impeller upgrades provided in lift station design

Results of the analysis show that most of the lift stations and all of the force mains are capable of conveying projected flows for 2012, as well as ultimate scenarios. There are three lift stations which may have capacity problems based on the analysis. Misty Cove and Baxter Lift Stations are located in Mini Basin 54, which was calibrated in 2005. The service area for Baxter Lift Station includes large multi-family development which was added since the model calibration, and may be simulating sanitary flows that are larger than what actually occurs. The second pump for Misty Cove Lift Station only activated 3 times during the peak storm event.

East Valley Lift Station also exceeded its capacity during both simulations. The City provided data for this lift station during the calibration process. This data indicated that a second pump did activate a few times during the December 2010 storm used in the Calibration.

The second pump did not activate for Long Lift Station7. However, the station was close to its single pump capacity during the ultimate model simulation. Therefore, it is possible that the lift station will eventually exceed its capacity if the service area sees significant population growth.

INFILTRATION AND INFLOW ANALYSIS

The runoff simulations for the 2012 model analysis were reviewed to estimate the peak inflow to the sewer system due to infiltration and inflow. This was done by determining the peak modeled RDII flow rate for the catchments in each calibrated mini-basin and dividing this by the area. Results of this analysis are provided in **Table 5-6**.

**Table 5-6
Peak Infiltration and Inflow per Mini-Basin**

Sewer Mini-Basin	Peak Storm Event	Peak I/I ⁽¹⁾ (gpad)	Calibration Year ⁽²⁾
1	November 4, 1998	4,580	2005
2	November 4, 1998	3,902	2005
3	November 4, 1998	4,062	2005
4	January 9, 1990	1,700	2015
5	November 24, 1990	19,223	2015
6	November 24, 1990	3,436	2015
7	November 4, 1998	6,618	2005
8	February 8, 1996	1,330	2005
9	February 8, 1996	7,718	2005
10	February 8, 1996	4,009	2005
11	February 8, 1996	7,724	2005
12	February 8, 1996	2,076	2005
13	February 8, 1996	17,189	2005
14	February 8, 1996	6,595	2005
15	February 8, 1996	9,248	2005
16	February 8, 1996	3,725	2005
17	November 24, 1990	6,17	2015
18	February 8, 1996	5,927	2005
19	February 8, 1996	1,140	2015
20	November 24, 1990	1,650	2005
21	November 24, 1990	2,443	2005
22	November 24, 1990	585	2005
23	January 9, 1990	539	2015
24	February 8, 1996	6,616	2015
25	November 24, 1990	4,400	2015
26	November 24, 1990	2,251	2005
27	February 8, 1996	3,595	2015
28	February 8, 1996	4,907	2005
29	February 8, 1996	3,924	2015
30A	February 8, 1996	860	2015
30B	February 8, 1996	329	2015
30C	February 8, 1996	860	2015*
32	February 8, 1996	2,413	2005
33	January 9, 1990	798	2015
34	January 9, 1990	842	2015
35	November 24, 1990	1,199	2005
36	February 8, 1996	6,824	2015
37	February 8, 1996	7,085	2015

**Table 5-6
Peak Infiltration and Inflow per Mini-Basin**

Sewer Mini-Basin	Peak Storm Event	Peak I/I ⁽¹⁾ (gpad)	Calibration Year ⁽²⁾
39	February 8, 1996	3,985	2015
40	February 8, 1996	3,891	2005
41	February 8, 1996	6,712	2015
42	January 9, 1990	2,804	2005
43	November 24, 1990	548	2015
44	November 24, 1990	37	2005
45	November 4, 1998	602	2005
46	November 24, 1990	3,081	2005
47	November 24, 1990	7,326	2015
48	February 8, 1996	2,065	2015
49	February 8, 1996	3,331	2015
50	February 8, 1996	12,370	2005
52	February 8, 1996	1,468	2005
54	February 8, 1996	4,429	2005
A	February 8, 1996	10,232	2005**
B	February 8, 1996	3,932	2005**
CEDAR02A	November 24, 1990	3,088	2005
ESI1003	February 8, 1996	10,225	2005
RENT65	January 9, 1990	1,450	2015

1) RDII parameters determined in the 2005 wet weather calibration were set using wet weather at the Mini-Basin level. Those modified in the 2015 calibration were set at the model basin level.

* Mini-Basin Basin 30C was calibrated with Basin 30A.

** RDII parameters for Mini-Basins A and B were not calibrated. During the 2005 model development, RDII parameters from adjacent basins with similar land use were assigned.

Peak I/I flow rates for a 15 basins are very high, exceeding 6,000 gallons per acre per day. The calibration for many of these basins was performed in 2005. The I/I flow rates for Mini-Basin 5 and 13 exceed 15,000 gallons per acre per day. Although the calibration for Mini-Basin 5 was performed in 2015, it was done at the model basin level, and included decreases in the I/I parameters from the prior calibration. Mini-Basin 13 was calibrated in 2005. The 2012 and Ultimate model results show pipe capacity problems for many of the basins with high I/I flow rates. Therefore, we recommend additional flow monitoring to verify the calibration in these basins. The Mini-Basin 44 I/I flow rate is extremely low, so flow-monitoring is also recommended to for this basin. See Chapter 6 for further discussion.

PEAK BOUNDARY FLOW ANALYSIS

The peak flow rates for each of the external boundary flows are tabulated below in **Table 5-7**. The flow rates for SOO003 and RNT042 were constant flow inputs. The rest of the flows were time series inputs. Since four separate storm events were

PEAK BOUNDARY FLOW ANALYSIS

The peak flow rates for each of the external boundary flows are tabulated below in **Table 5-7**. The flow rates for SOO003 and RNT042 were constant flow inputs. The rest of the flows were time series inputs. Since four separate storm events were used in the model analysis, the peaks were different magnitudes for each event. The peaks were also from different events depending on the boundary condition. For this table, the largest peak event was listed.

Table 5-7
Peak Boundary Flows

Boundary Flow	Peak 2012 Flow (cfs)	Peak Ultimate Flow (cfs)
TUK015	24.16	34.50
SINT020	156.11	291.24
SOO021	2.62	4.42
SOO003	7.90	17.20
Cedar039A	13.56	21.02
RNT042	1.1	3.6
ESI4024	261.13	428.46
BLS043B	24.67	34.17

Figure 5.2
2012 Sewer Model Analysis Results

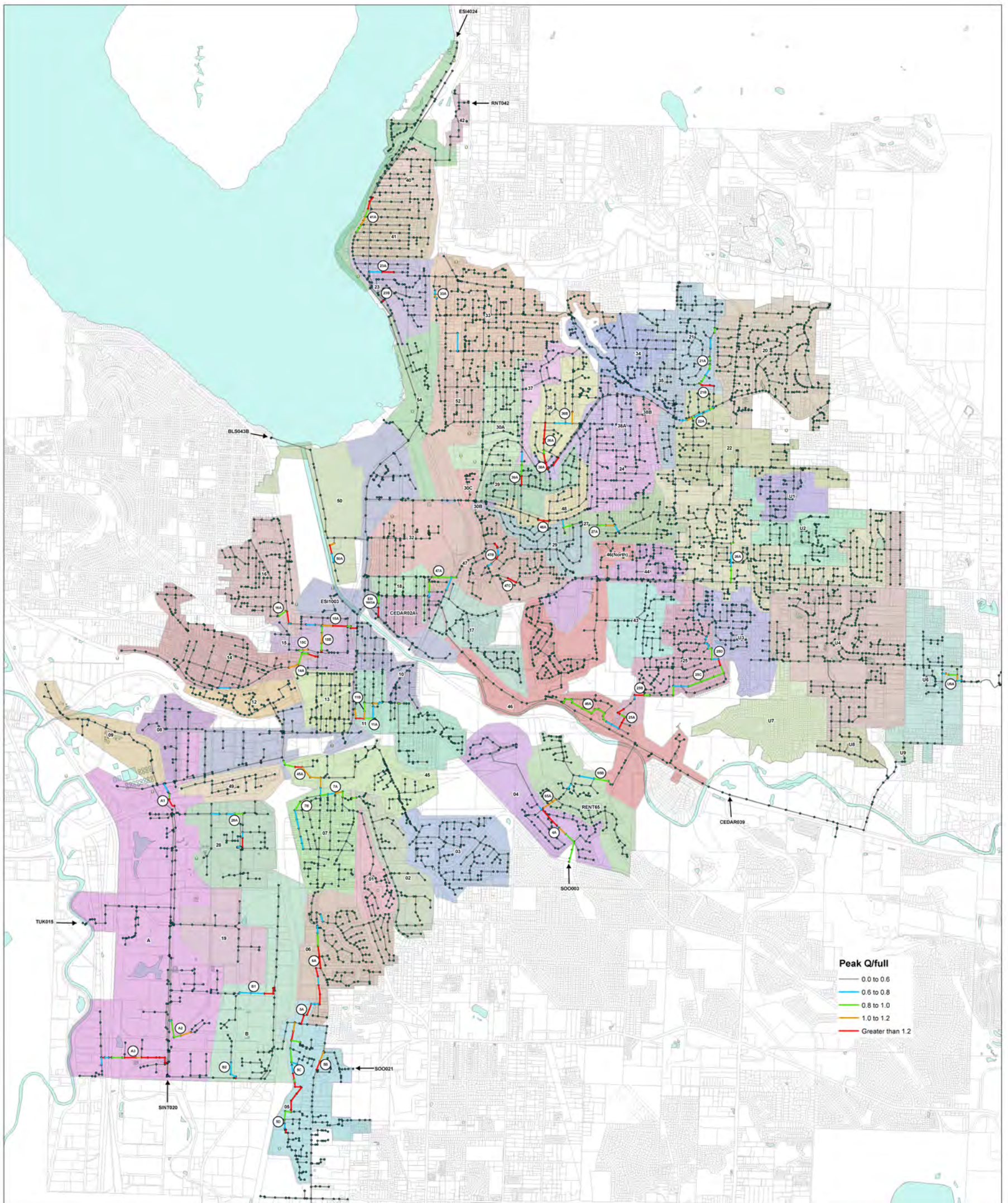

Figure 5-2
City of Renton
2012 Sewer Model Analysis Results



Figure 5.3
Ultimate Sewer Model Analysis Results

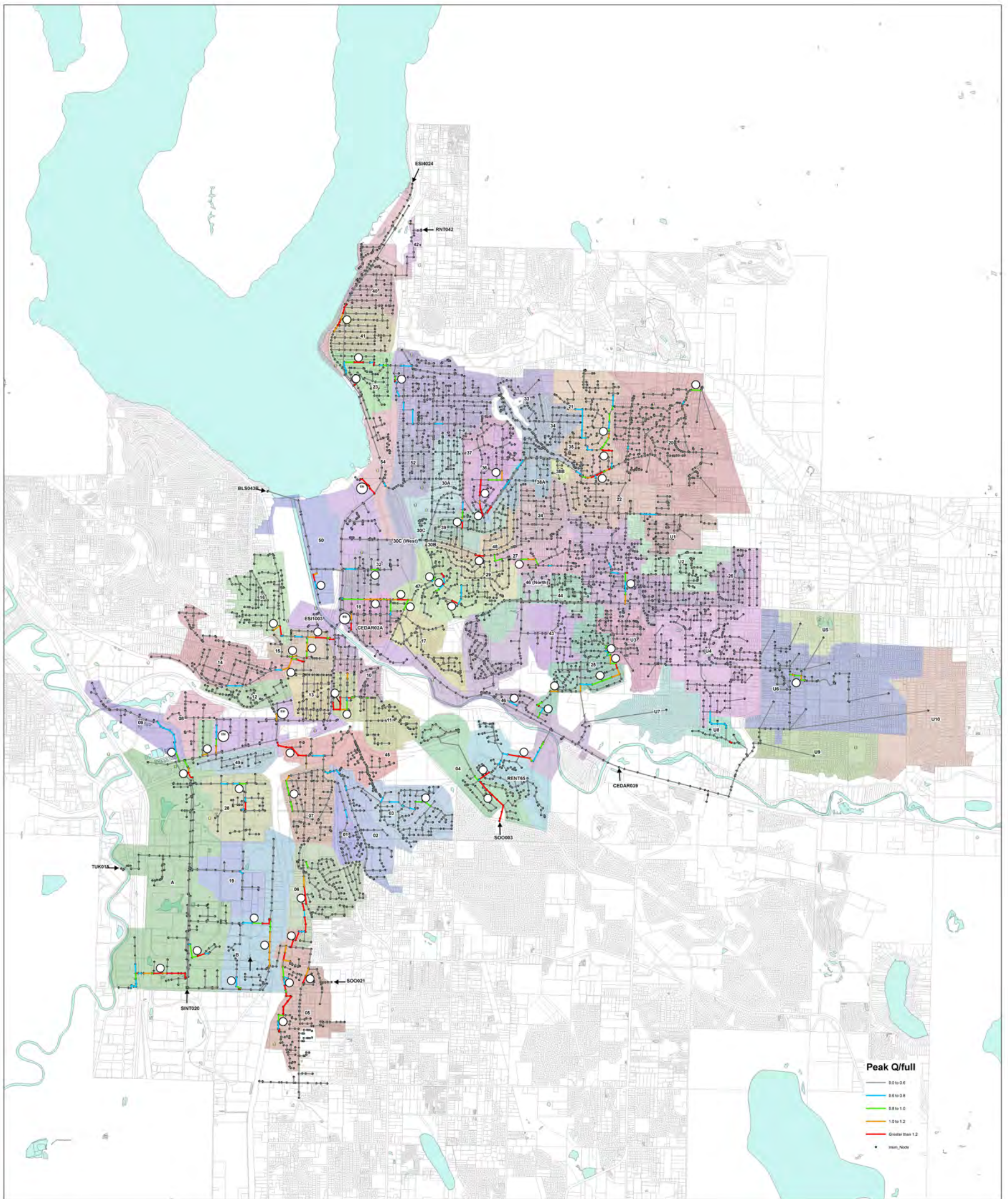

Figure 5-3
City of Renton
Ultimate Sewer Model Analysis Results



This section of the report includes the recommendations for future flow monitoring and model updates. A summary of the King County hydraulic model compatibility and limitations of the model have also been included.

FLOW MONITORING RECOMMENDATIONS

As mentioned previously in this report, additional flow monitoring and analysis can be a worthwhile supplement to hydraulic modeling and verification of capacity deficiencies. **Figure 6-1** (located at the end of this chapter) identifies recommended future modeling locations, and **Table 6-1** lists the specific recommended locations for future monitors in addition to the general categories of the monitors. **Figure 6-1** includes the following four categories of flow meters:

1. Locations of King County flow monitors from 2008-2011 (**Black Rings**): These are locations where flow monitoring was conducted by King County for the decennial monitoring program, but much of the recorded data was missing or errant due to flow monitor issues. Additional monitoring is warranted at these locations to verify the flows in the tributary basins.
2. Locations which King County did not monitor from 2008-2011 (**Orange Rings**): These locations include large tributary basin areas, and were not monitored. In some cases, downstream monitors did collect these tributary flow data, but the data is not detailed enough to examine the smaller upstream areas. Other locations are newer Mini-Basins or Sub-Basins, which have seen substantial growth since the model was developed. Monitoring is warranted at these locations to verify the flows in the tributary basins.
3. New flow meter locations to monitor specific 2012 Model problem areas (**Violet Rings**): These locations would provide targeted monitoring to isolate and verify some of the more serious problem areas as identified by the 2012 Model Peak Flow Analysis. These areas are typically not immediately adjacent to previous flow monitor locations, or would be used to separate large branches of upstream sewer to help identify the cause and location of problems. Where feasible, attempts were made to select locations where a single meter could be used to help verify more than one problem area.
4. New flow meter locations to monitor specific Ultimate Model problem areas (**Blue Rings**): These locations would provide targeted monitoring to isolate and verify some of the more serious problem areas as identified by the Ultimate Model Peak Flow Analysis. These

areas are typically not immediately adjacent to previous flow monitor locations, or would be used to separate large branches of upstream sewer to help identify the cause and location of problems. Where feasible, attempts were made to select locations where a single meter could be used to help verify more than one problem area.

It might be wise to install flow monitors for suspected problem areas using a phased approach, rather than installing all of the meters at the same time. This would allow more opportunity for evaluation of the metering to make sure useful and reliable data is being provided.

Installation of flow meters at new locations or locations where data previously collected by King County was errant may potentially be a collaborative effort with King County, with each party sharing information and possibly expenses. Targeted use of flow meters could help locate areas with higher than normal I&I issues, which could potentially be repaired to avoid downstream piping upsizing and modifications. Flow monitors can be used to verify or refute projected capacity problems, potentially eliminating costly projects or providing confidence that improvements are warranted.

**Table 6-1
City of Renton Sewer Model
Proposed Flow Monitor Locations**

Basin	Flow Monitor MH*	Category**	Problem Area
3	MH0084 (SE)	2	
5	RE*SRENTON.R18-25 (S)	3	5B
5	RE*SRENTON.R18-17 (S)	3	5C
6	MH2999	3	5A, 6A
11	RE*ESI1.RO1-14 (E)	3	11A, 11B
13	MH2247 (N)	2	
14	MH0066 (W)	3	14A
15	MH2120 (W)	3	15A, 15B, 15C
16	MH2113 (W)	4	16A
19	MH0246 (E)	1	
21	MH5503 (N)	3	21A, 21B
22	MH3626 (E)	4	22A
23	MH0383 (NE)	1,3	23A, 23B
25	MH1650 (N)	4	2BC, 25D, 25E
26, U2	MH1746 (E)	2	
26	MH1741 (N)	4	26A
38A	MH0466 (N)	3	36A, 36B, 38A
39	MH0825 (N)	3	39A
40	RE*ESI4.RO2-19 (E)	1	

**Table 6-1
City of Renton Sewer Model
Proposed Flow Monitor Locations**

Basin	Flow Monitor MH*	Category**	Problem Area
41	MH3511 (SW)	1,3	41A
42	MH3386 (N)	1	
44	MH1264 (E)	2	
45	MH2253 (E)	3	45A
47	MH4646 (E)	3	47B, 47C
47	MH2014 (N)		
48	MH0843 (E)	3	48A
50	MH0420 (S)	4	50A
RENT65	MH5302 (W)	2,4	65B
RENT65	MH2760 (SW)	2,3	4a, 65A
ESI1003	MH4629 (W)	4	ESI1003B
ESI1003	MH1924 (S)	4	ESI1003A
A	MH0211 (S)	3	A1
A	MH6191 (E)	3	A2
A	MH0286 (W)	3	A3
B	MH2982 (S)	3	B1
B	MH3187 (N)	2,4	B3
U3	MH1709 (E)	2	
U4, U6, U8 & U9	RE*CENTRALPLAT.MH-5 (N)	1	
U6	MH4712 (E)	4	U6A

* Proposed flow monitor locations include the necessary orientation. For example " (E)" indicates that the monitor would be installed in the pipe entering the identified manhole to the East.

**Categories are as follows:

- 1) King County flow monitors with errant data
- 2) No Prior flow monitors – Mini-Basin flow verification
- 3) 2012 Model problem areas
- 4) Ultimate Model problem areas

KING COUNTY COMPATIBILITY

The model was updated with the intent of achieving general compatibility with the models developed by King County during the Regional I&I study. Many of the assumptions and methodologies employed by the City and County models are consistent. Overall, the models are fairly compatible, and data can be shared between the models in a relatively straightforward fashion. Some of the main similarities between the models are listed below:

- Both models use the MOUSE hydraulic engine (MIKE URBAN runs on the MOUSE engine).
- The same formula was used for computing the base I&I for each mini-basin in the two models.
- Both models include population projections based on PSRC planning data.
- Both models use similar RDII parameters.
- Both models were calibrated to the same dry weather and wet weather flow monitoring data.
- DHI worked on calibrating the County's and City's original models for the wet weather season, and employed a similar methodology for both.
- Both models use similar rainfall gauge assignments.
- Both models feature detailed representations of King County trunklines within the City boundaries.
- Boundary flow assignments to the City's model conservatively represent boundary flow rates computed by King County.
- Both models incorporate an assumed system degradation resulting in an I&I increase of 7.0 percent per decade. The City of Renton assumes a maximum increase of 28.0 percent for the Ultimate Models, whereas King County does not apply a cap for future projections.
- Both models use the same hydraulic engine and computations, and both feature a similar overall set-up.

There are some key differences between the City's model and the King County models. The City's model is much more detailed than any of the County's models in terms of the representation of the physical system. The majority of the City's system is included in the model, with flow present in all of the pipes. The physical detail in the City's model allows it to be a powerful hydraulic tool for evaluation of system capacity at a local level. With the City's model, it is possible to evaluate pipes as small as 8-inch diameter to evaluate capacity, throughout the City. The County's model is intended to be a regional tool used to evaluate I&I and system capacity at a much broader and less refined level. With the models developed by the County, hydraulic evaluation of large sewer trunks is possible, but generally not smaller pipes. The County's models are primarily hydrology models, with hydraulics for trunks. The City's model is both a hydrologic and hydraulic model throughout. Some other key differences in the models are summarized below:

- The population is assigned more representatively to the City's model, by zoning categories. The City's model has individual populations assigned to manholes by zone, while the County's model feature lump net flow assignments, not targeted to specific zoning categories by individual manholes. The net results at the outlet of each mini-basin should be similar, but the flow in the local system is more representative in the City's model.
- A conservative factor of 25% was added to all of the projected populations within the City's model. The County may have applied different measures of conservatism into their models, but it is believed that they did not apply a 25% increase to the population assignments.
- Efforts were made in the City's model to check to make sure realistic per capita flow rates were assigned, and adjustments to projected population distributions were made as deemed appropriate.
- The area assignments between the models differ. King County applied several discount factors reducing the area assigned to each mini-basin. In the City's model, the overall areas (generally not including parks and open space) were equally assigned to all of the manholes within each mini-basin. As a result, much larger overall areas were assigned to the 2012 Renton Model. This does not create a difference in the calibrated wet weather flows for the 2012 model, but may have an impact to flows in the Ultimate Model and future scenarios.
- The City's model has the ability to accurately simulate lift station operation and settings, whereas the County's models did not generally include that level of detail. The County did not model lift station operation, focusing instead on the larger picture.
- The original wet weather calibration for Renton's model started with similar RDII parameters to King County, but these were refined by DHI, and further refined by Stantec to provide a more representative and system specific calibration.
- The County performed complex statistical analyses and developed synthetic storm events to represent 20-year peak flows within the various basins. The scope and budget of the City's model did not support this level of analysis. Per the County's suggestion, events ranked by the County were assumed to represent the various storm events used for the City's analyses.
- The County's Ultimate models do not use diurnal sanitary flows; instead, they use a constant average sanitary flow rate throughout the model simulations.
- Due to the system-specific detail in the City's model, it takes significantly longer to perform computations.

- The County generally uses more conservative I&I assumptions (such as 2,000 gallons per acre per day) for areas projected to be served in the future (the City generally used 1500 gallons per acre per day for new projected areas).

LIMITATIONS OF THE MODEL

The limitations of the model generally relate to limitations in the data and assumptions used to develop the model, the budget used to develop the model, and limitations of the software. Some of the main limitations are summarized below:

- The data used to develop the City's model was found to contain a large volume of missing information, incorrect information, and inconsistencies. Numerous assumptions were used to correct this data, including interpolations and datum assumptions. Although the piping in the model all flows downhill, there is certainly a portion of model data that is inaccurate to some extent.
- The diurnal curves assigned to the model apply to the overall mini-basins. Targeted diurnal curves used for each zoning category were not used; therefore, although flow is represented in all of the piping throughout the model, it can be considered an average of the upstream flow generation at any point. The diurnal curve applied to any node within a mini-basin will have the average flow values for the total system, but may not represent the actual specific flow patterns from an individual area, such as a school. The diurnal patterns generally represent the overall make-up of the mini-basins (residential versus employment, etc.).
- Although I&I is assigned to most of the manholes in each mini-basin, weighted areas to each manhole were not assigned; most manholes typically receive the average area for the mini-basin. This functions to distribute average mini-basin I&I rates to each manhole, but does not isolate I&I issues within each mini-basin, since only the total flow at the downstream monitors were used to calibrate the flows.
- The RDII parameters used to develop the antecedent soil and groundwater conditions are very complex, and difficult to accurately represent. The County performed more extensive research and evaluation when determining their parameters, the results of which were largely applied to the City's model. However, the specific conditions defining how surface water and groundwater enter the sewage system are extremely complex, and the RDII parameters assigned to the model will not necessarily be able to accurately predict future performance, even though they were determined and estimated using flow monitoring data from a couple of seasons.

- The storm events assigned to the model may or may not provide representative 20/30-year design flows within the system. The extent of the rainfall data analyzed by King County was approximately 60 years, and there are no guarantees that the storm flow rankings correspond to the appropriate storm events over that limited period of data.
- There were many inconsistencies, gaps, and a lot of “noise” in the flow monitoring data obtained by the County, and calibration was anything but an exact science. For some basins, the data was non-existent or inadequate to provide accurate calibrations. Without further flow monitoring efforts, there should be limited confidence in any of the projected flow rates from non-calibrated basins/mini-basins.
- The flow monitoring data obtained from the County was collected at the model basin level, which was at a much broader scale than the data collected for the 2001 I/I study, which was collected at the mini-basin level. Without more refined flow data, changes to the calibration of the model were less precise than the prior effort, and may have significant impacts on the analysis results.
- The large volume of data compiled from numerous sources and the extensive estimations, judgment, and assumptions used to create the model make it a very powerful tool, but common sense and sound engineering judgment should be applied to all results.

The data provided by model analysis is simply a planning level tool to determine areas that will need further analysis prior to implementation of any capital improvements. Additional analysis and flow-monitoring may be prudent prior to proceeding with large-scale system improvements in many parts of the system, as described earlier in this report in more detail. It is always advisable to apply sound engineering judgment coupled with real-world perspective to make sure that modeling results make sense and fit the appropriate conditions being studied. The physical components of projected “problem areas” such as manhole invert elevations, pipe slopes, and pipes sizes should be verified to ensure that the model is an accurate representation of the actual system.

Figure 6.1
Proposed Flow Monitor Locations

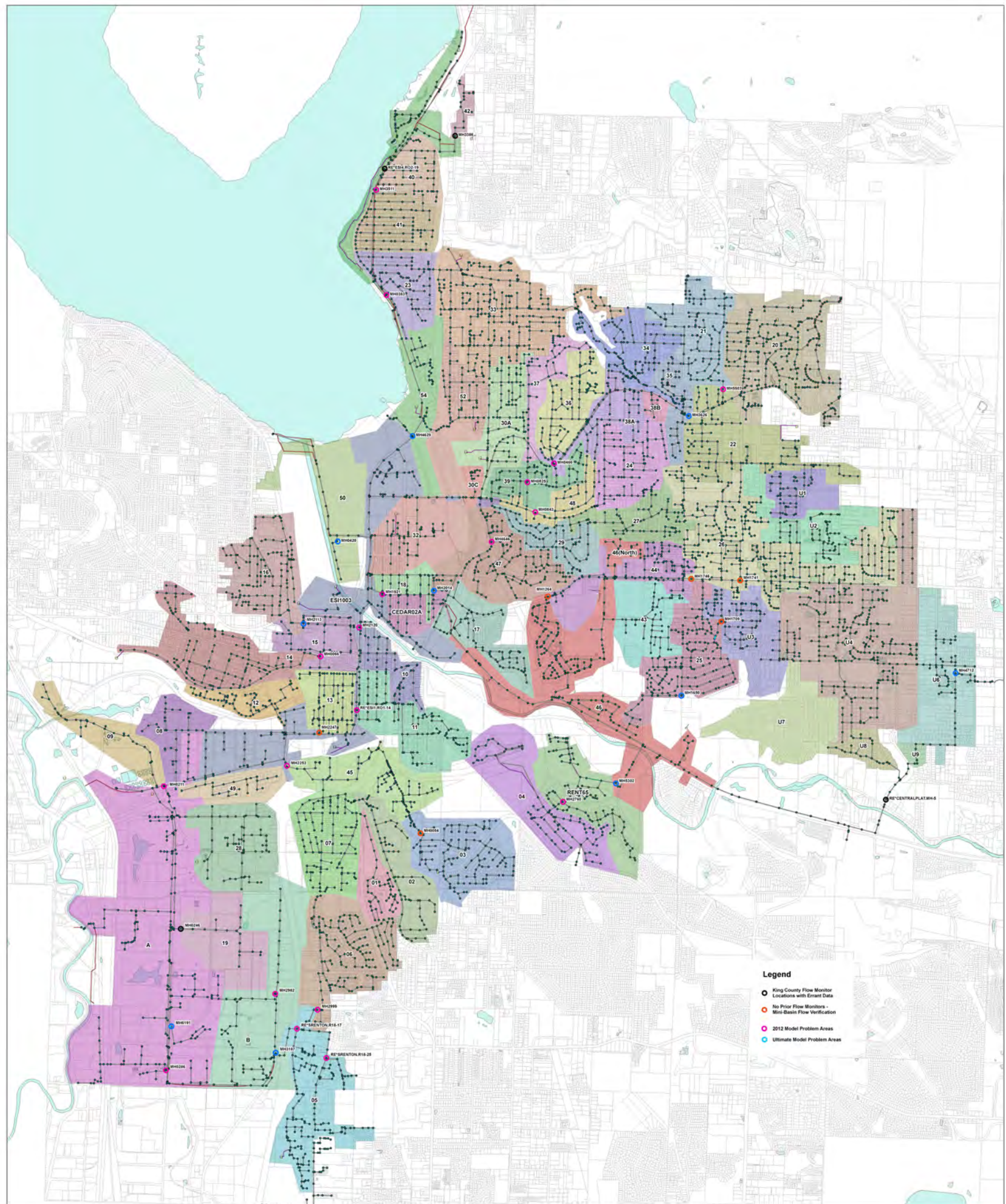
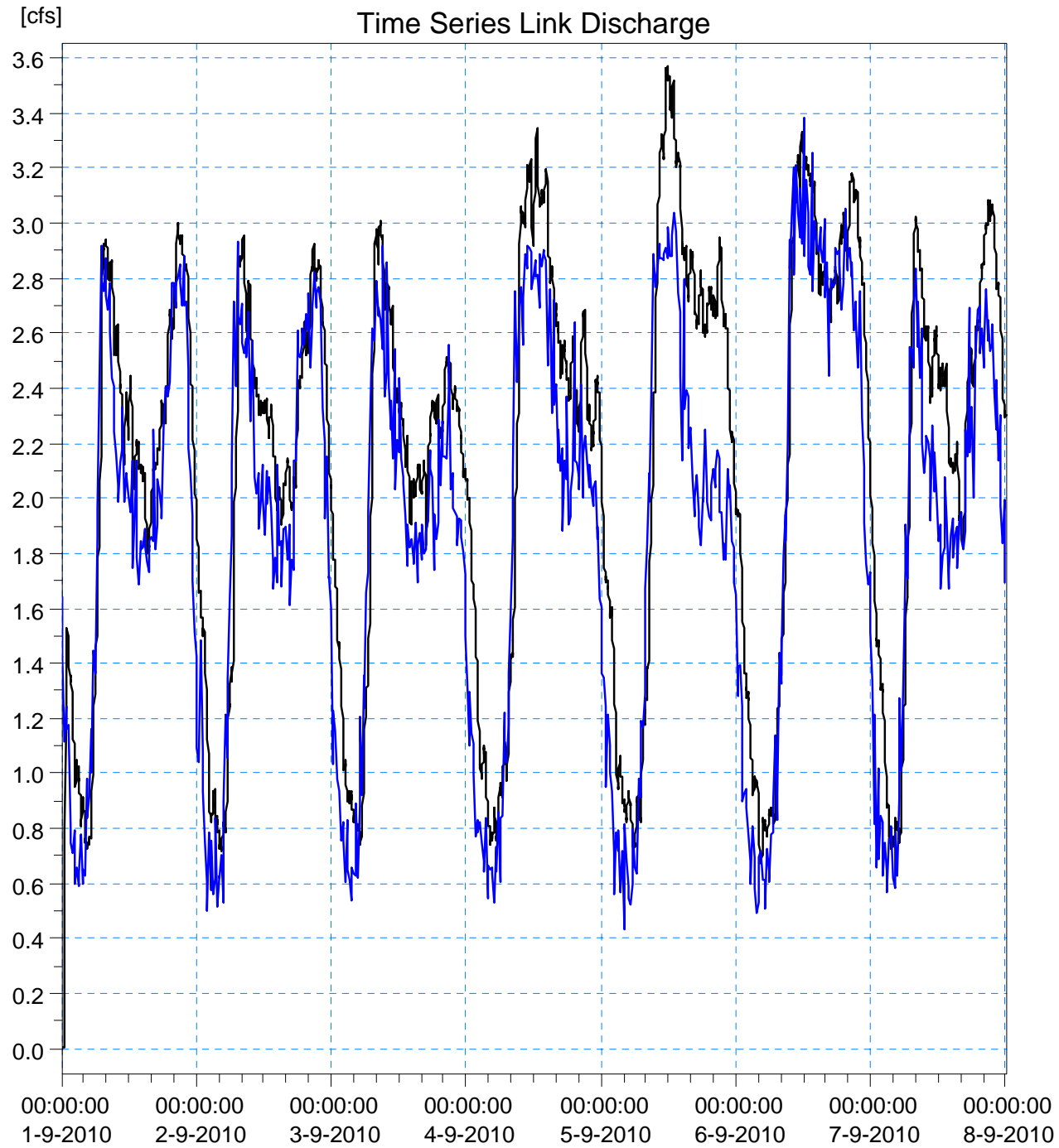

Figure 6-1
City of Renton
Proposed Flow Monitor Locations



APPENDIX A – Dry Weather Flow Calibration Time Series

Dry Calibration - Model Basin 65



Link Discharge (Model Output)
— GM05310 (MH5304 -> MH2759) 74.47

External TS 1 (Flow Monitor Data)
— Rent 65 Dry

Dry Calibration - Model Basin 17

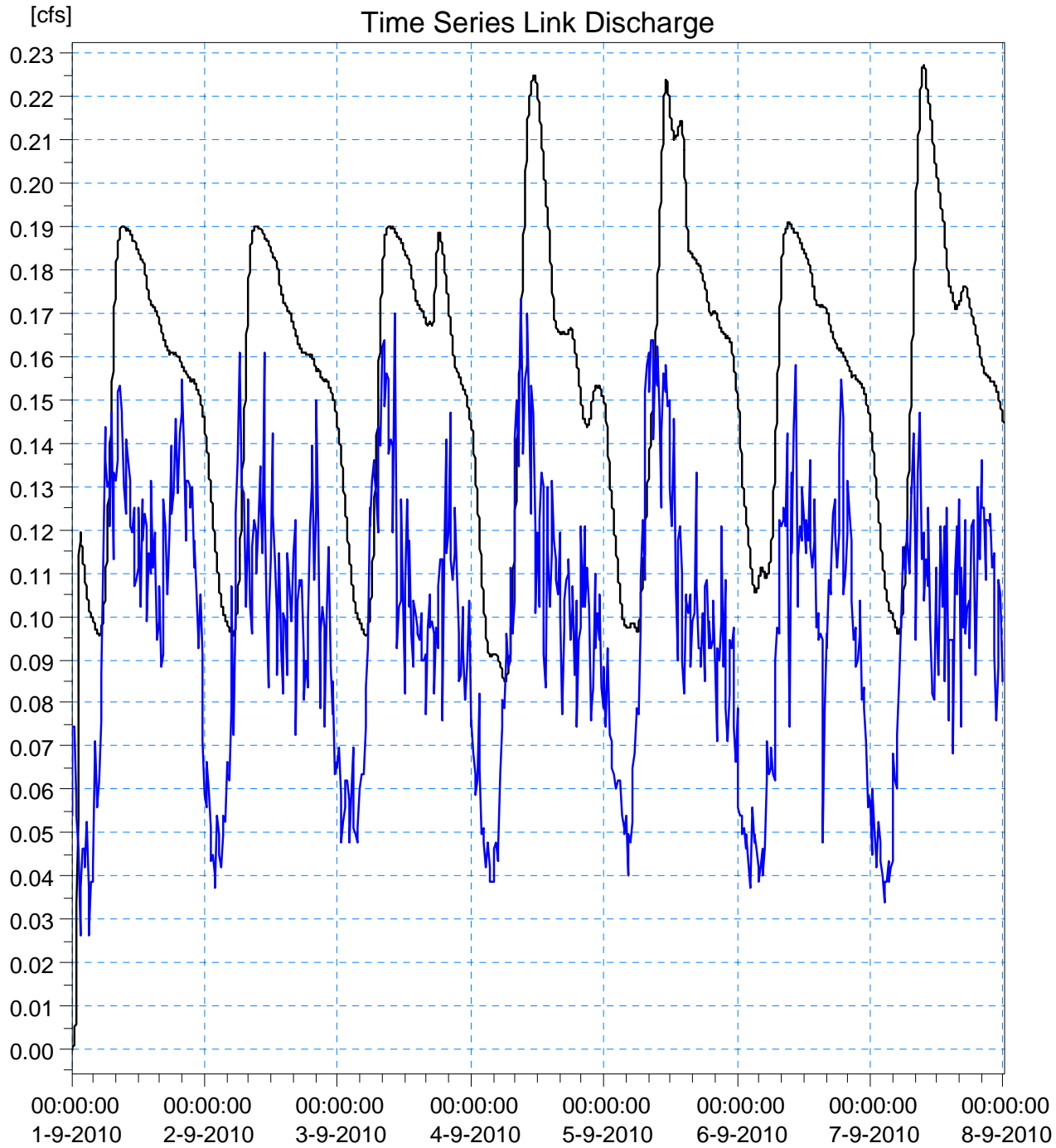

Link Discharge (Model Output)
— GM02800 (MH1852 -> MH1851) 120.91

External TS 1 (Flow Monitor Data)
— RNT 17 Dry

Note: Model output includes approximately 0.06 cfs of peak I/I flow modeled as dry weather flow.

Dry Calibration - Model Basin 23

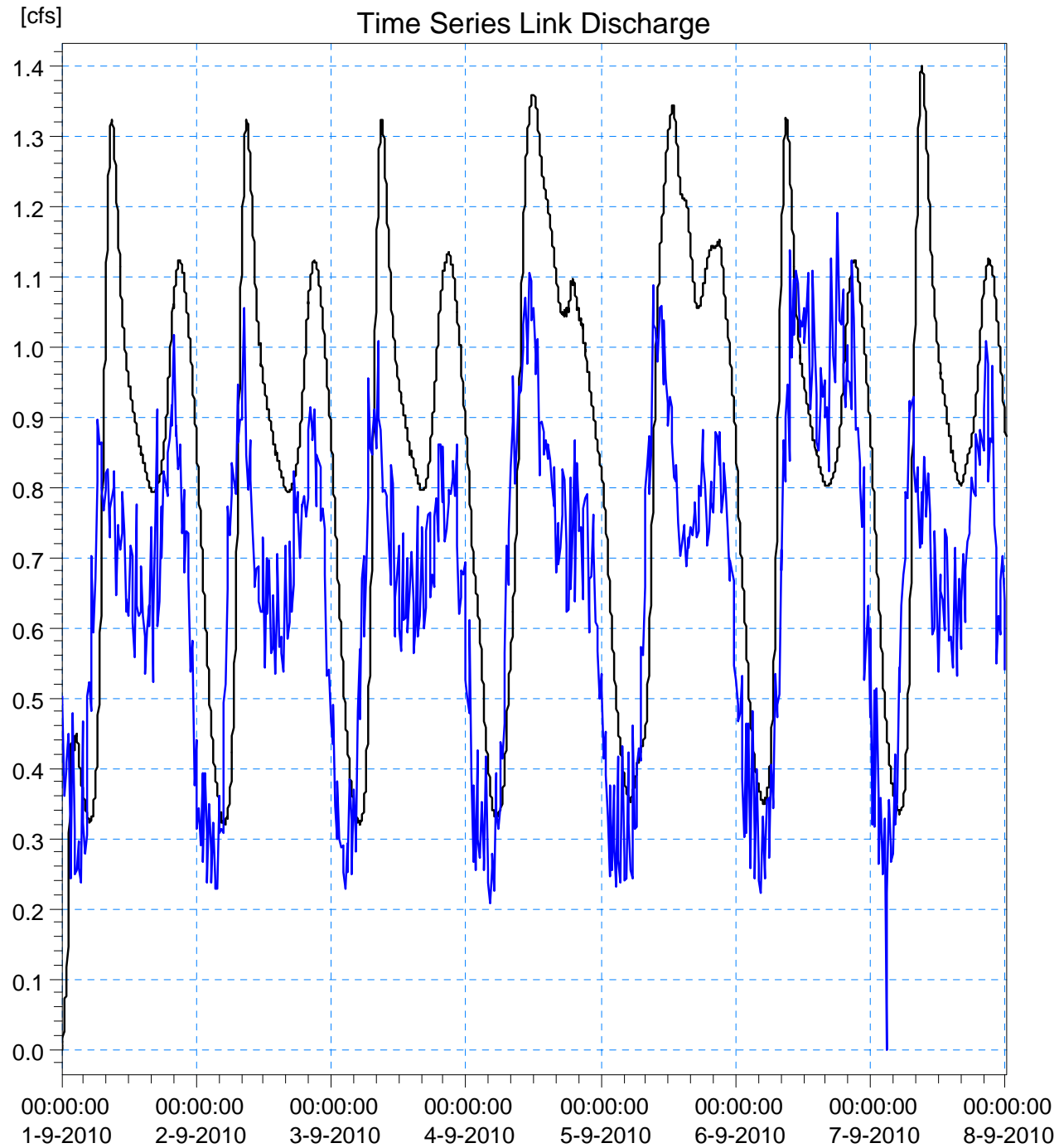

Link Discharge (Model Output)
— GM01571 (MH0520 -> MH0383) 24.48

External TS 1 (Flow Monitor Data)
— RNT 23 Dry

Note: Model output includes approximately 0.14 cfs of peak I/I flow modeled as dry weather flow.

Dry Calibration - Model Basin 25

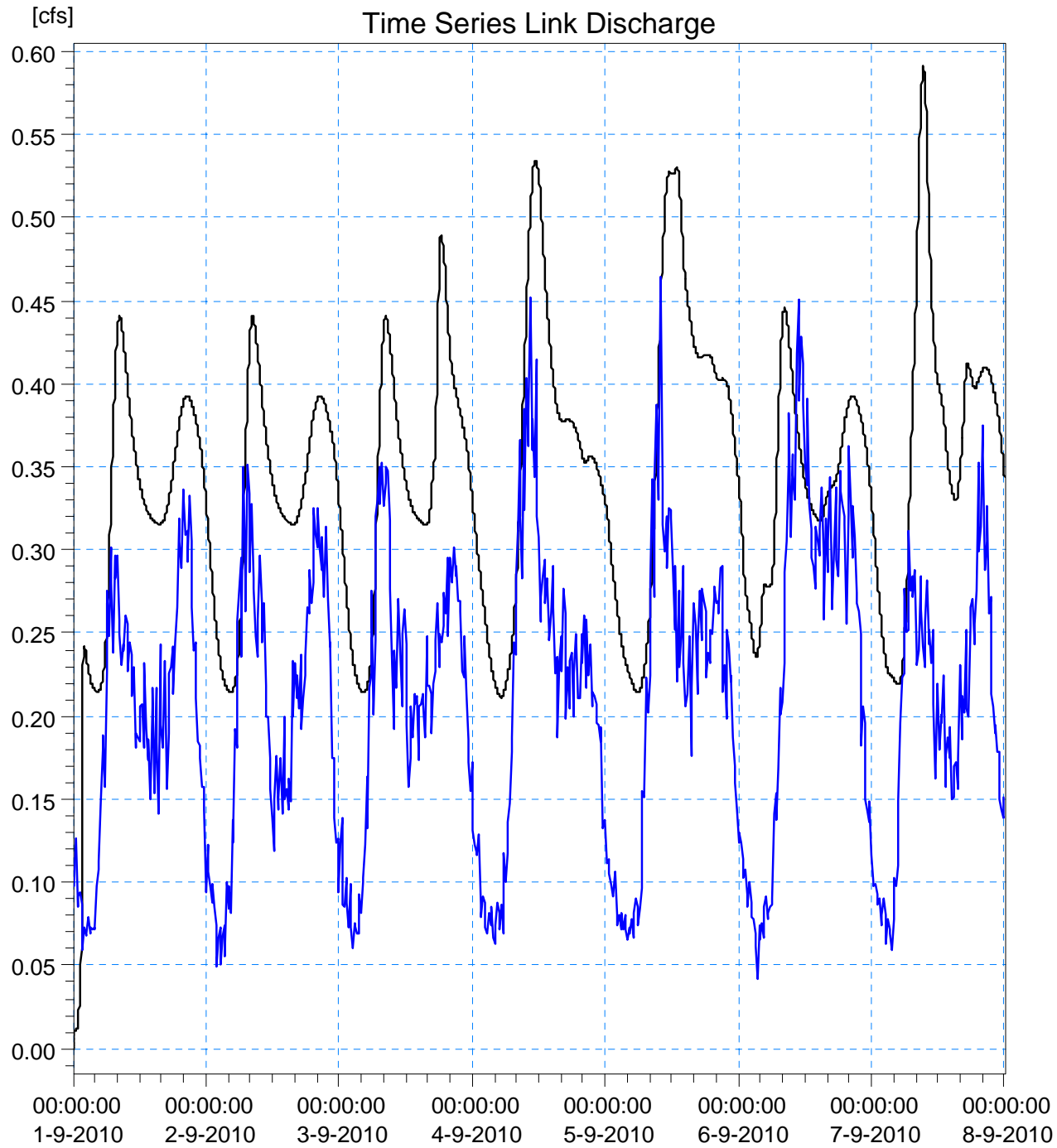

Link Discharge (Model Output)
— GM02237 (MH1773 -> MH1156) 109.94

External TS 1 (Flow Monitor Data)
— RNT 25 Dry

Note: Model output includes approximately 0.12 cfs of peak I/I flow modeled as dry weather flow.

Dry Calibration - Model Basin 28

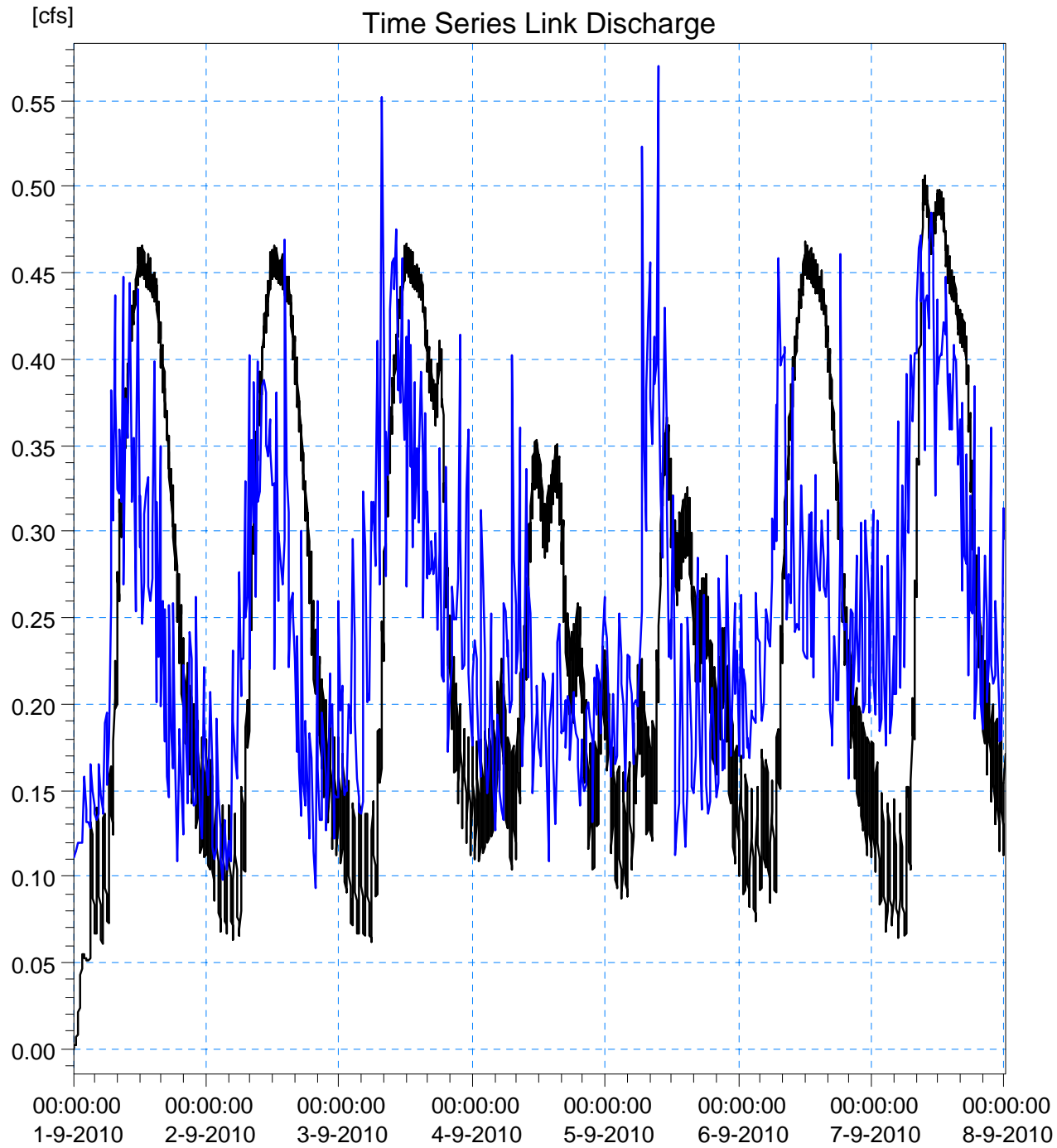

Link Discharge (Model Output)
— GM00108 (MH0206 -> MH0205) 108.45

External TS 1 (Flow Monitor Data)
— RNT 28 Dry

Dry Calibration - Basin 30A

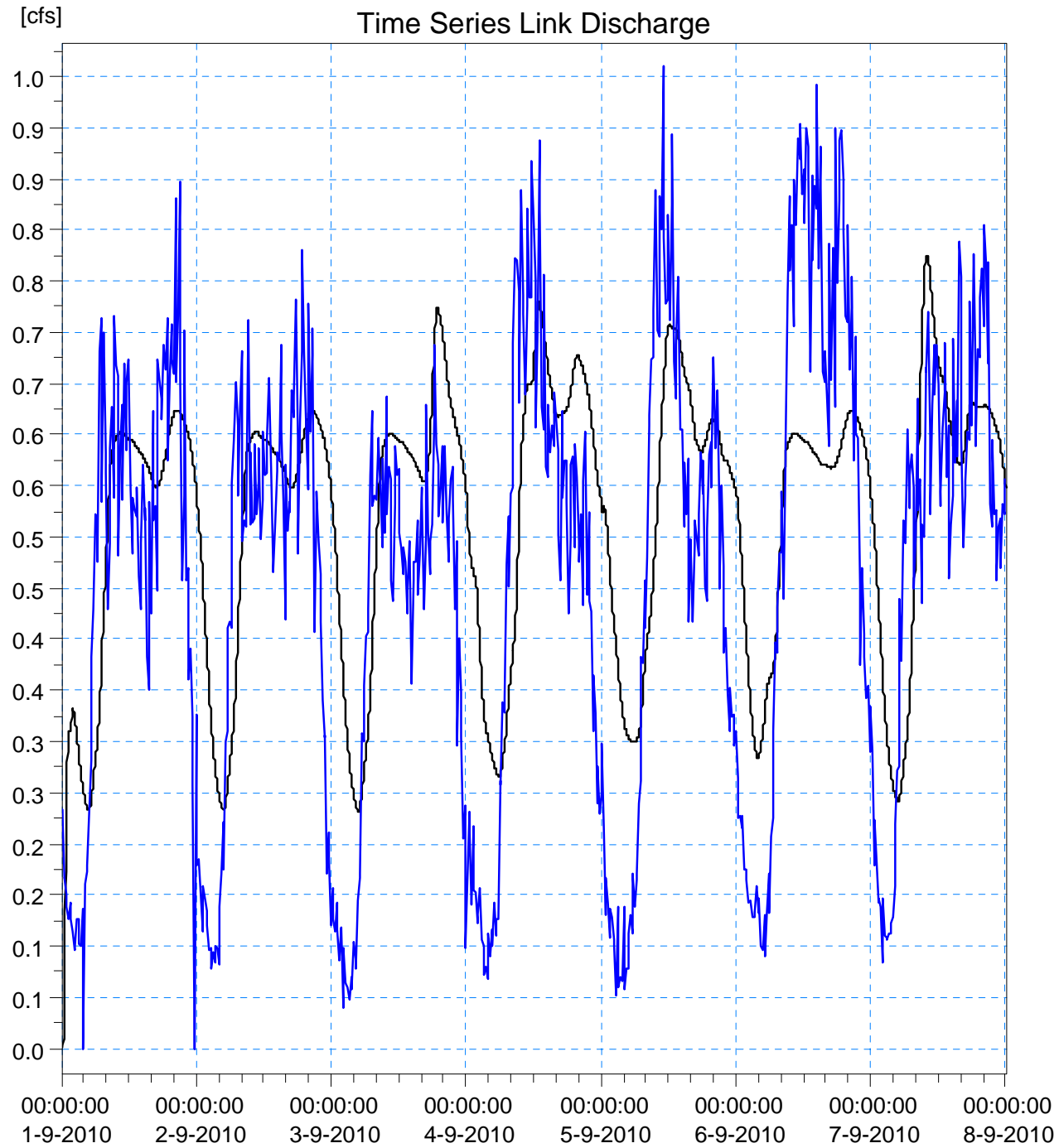

Link Discharge (Model Output)
— GM01793 (MH0715 -> MH0714) 90.57
External TS 1 (Flow Monitor Data)
— RNT 30A Dry

Dry Calibration - Basin 30B

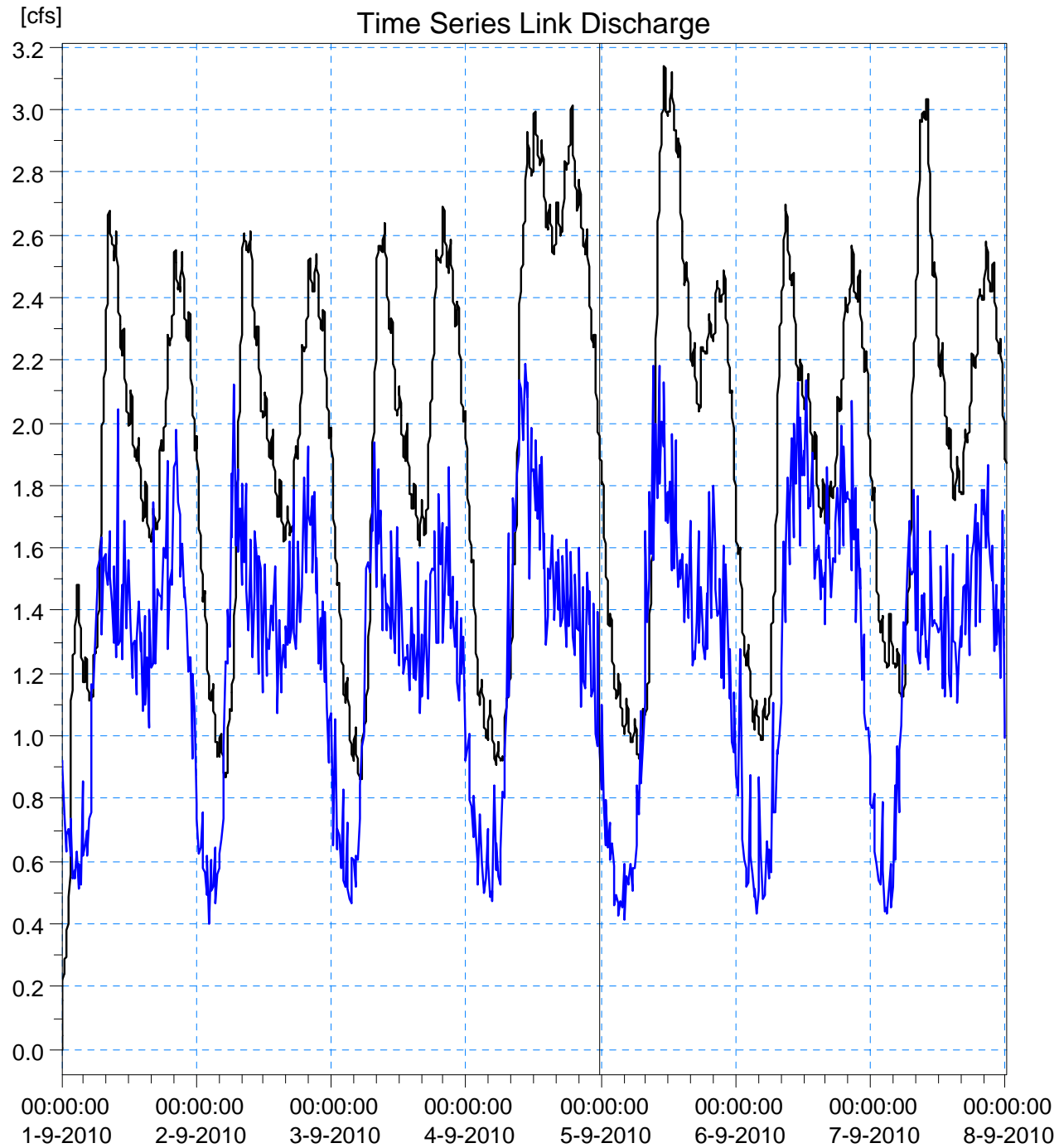

Link Discharge (Model Output)

— GM04481 (MH4653 -> MH4652) 99.98

External TS 1 (Flow Monitor Data)

— RNT 30B Dry

Note: Basin 30B flows into Basin 47. There were inconsistencies between the data of the two flow monitors.

Dry Calibration - Basin 35

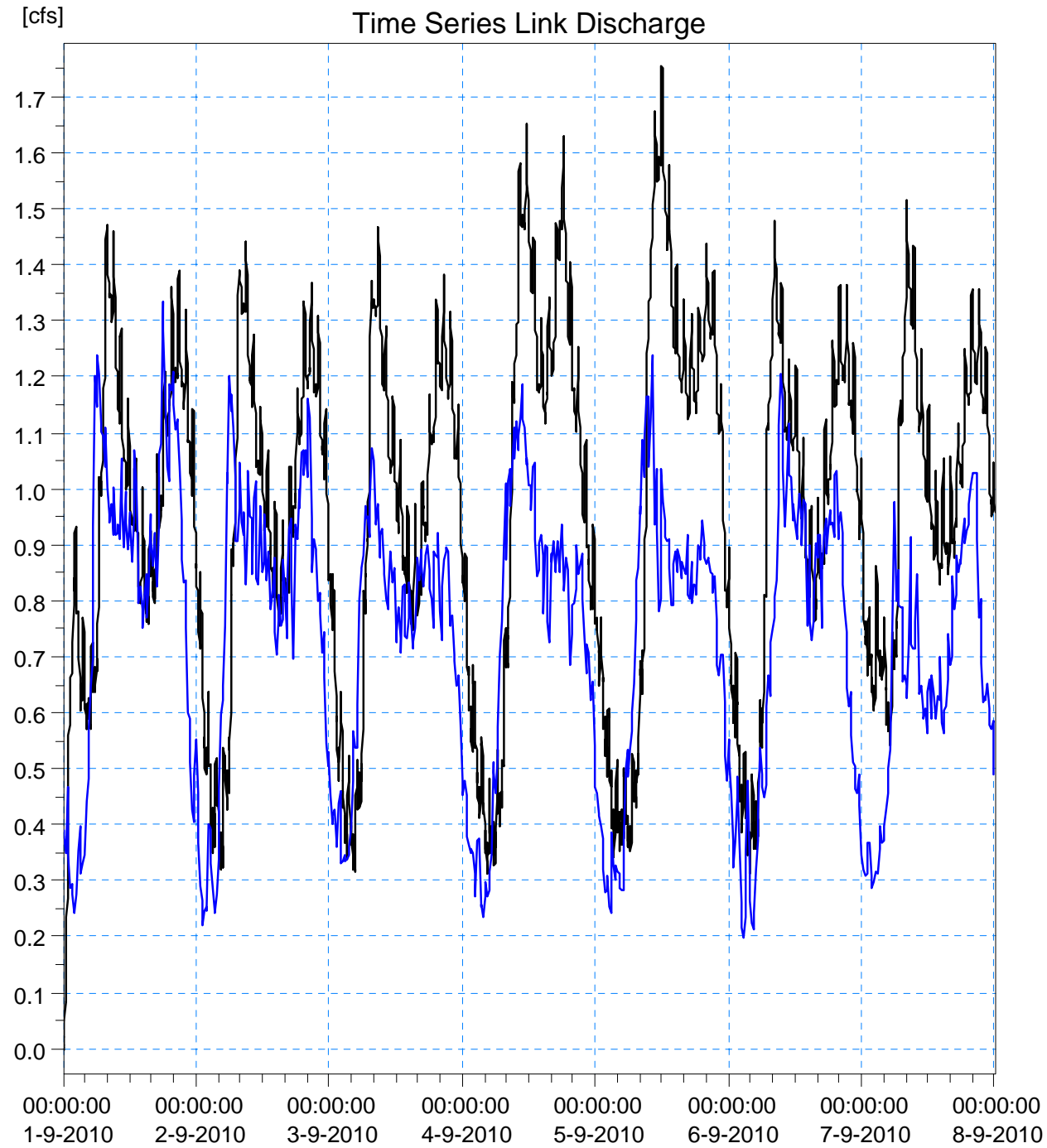

Link Discharge (Model Output)
— GM01350 (MH3756 -> MH0368) 113.70

External TS 1 (Flow Monitor Data)
— RNT 35 Dry

Note: Model output includes approximately 0.29 cfs of peak I/I flow modeled as dry weather flow.

Dry Calibration - Basin 41

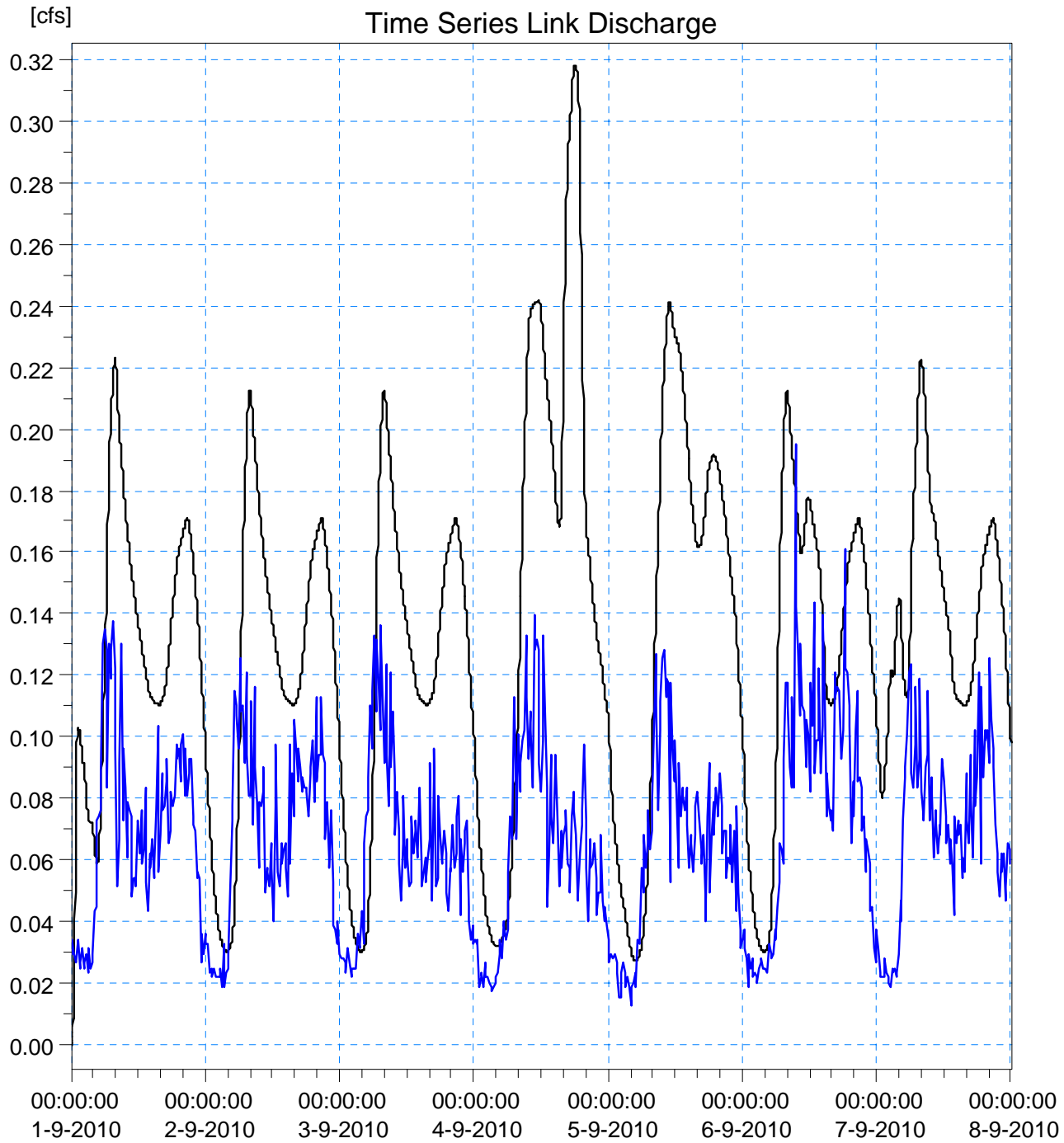

Link Discharge (Model Output)
— GM05921 (MH5705 -> MH3511) 83.15
External TS 1 (Flow Monitor Data)
— RNT 41 Dry

Note: Calibration is conservative

Dry Calibration - Basin 43

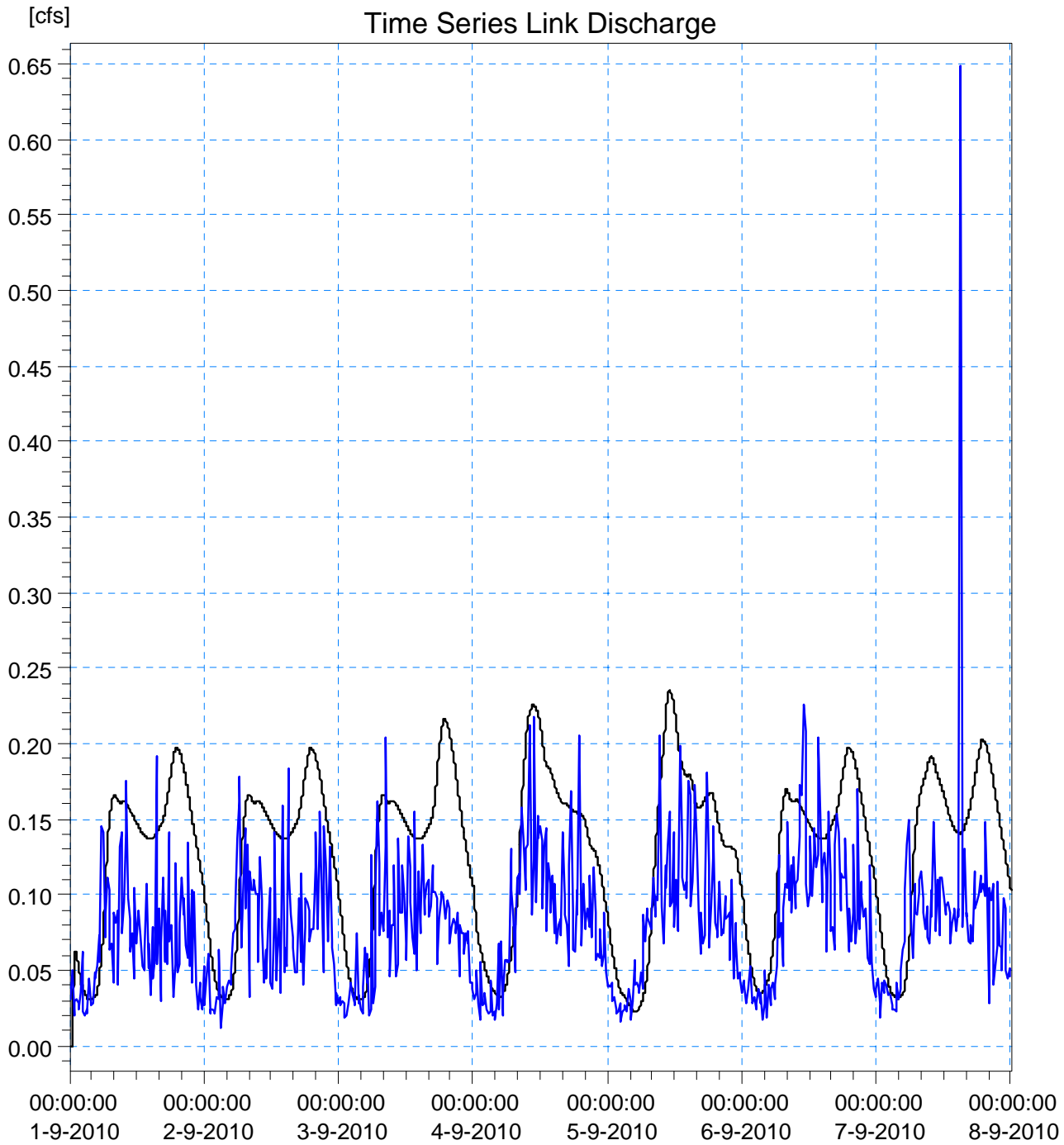

Link Discharge (Model Output)
— GM01059 (MH1205 -> MH1206) 79.00

External TS 1 (Flow Monitor Data)
— RNT 43 Dry

Dry Calibration - Basin 45

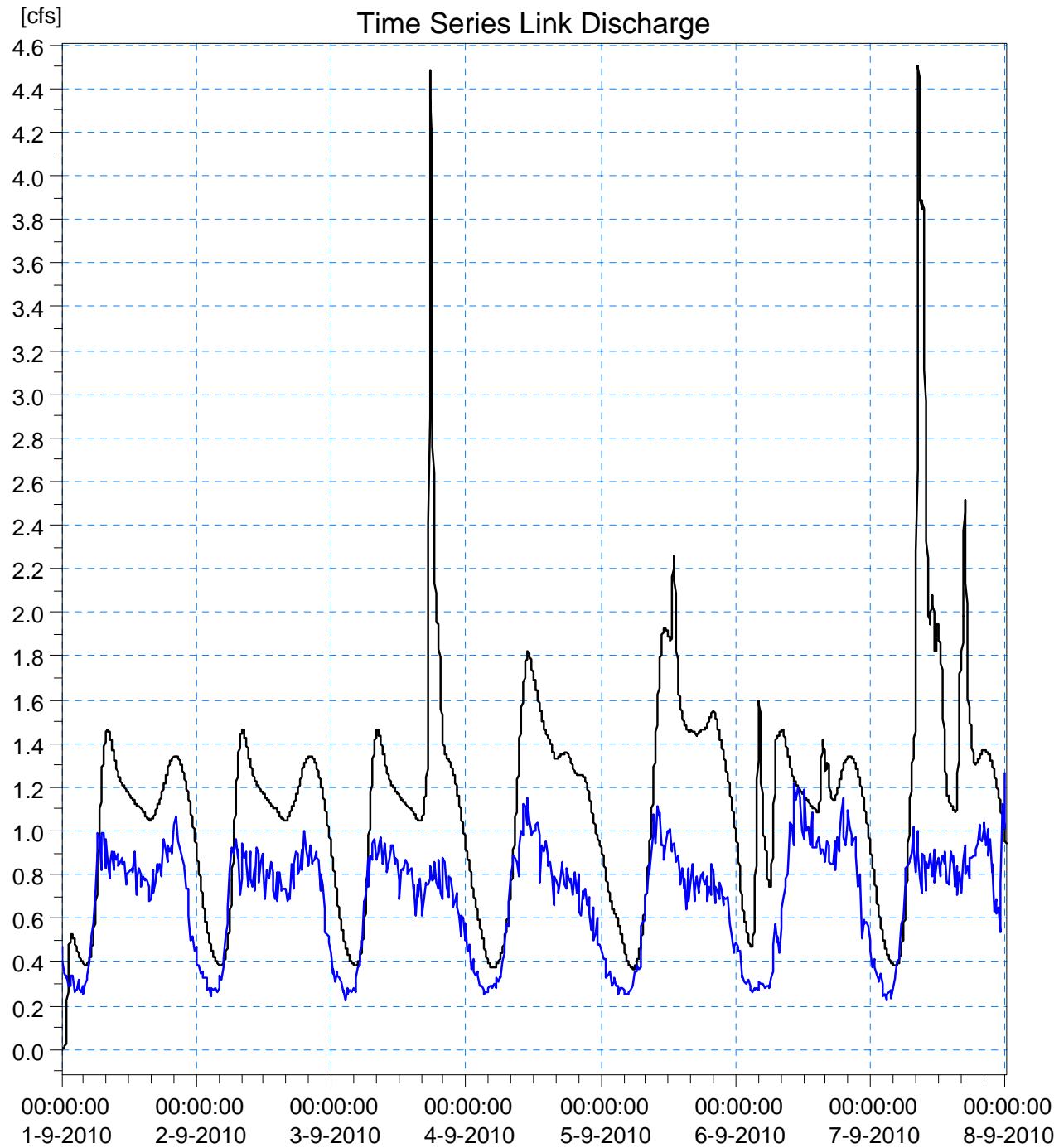

Link Discharge (Model Output)

— GM03455 (MH2254 -> MH2253) 87.38

External TS 1 (Flow Monitor Data)

— RNT 45 Dry

Note: Per discussions with City,
no modifications were made
from previous (2005) dry
weather per capita flow rates.

Dry Calibration - Basin 47

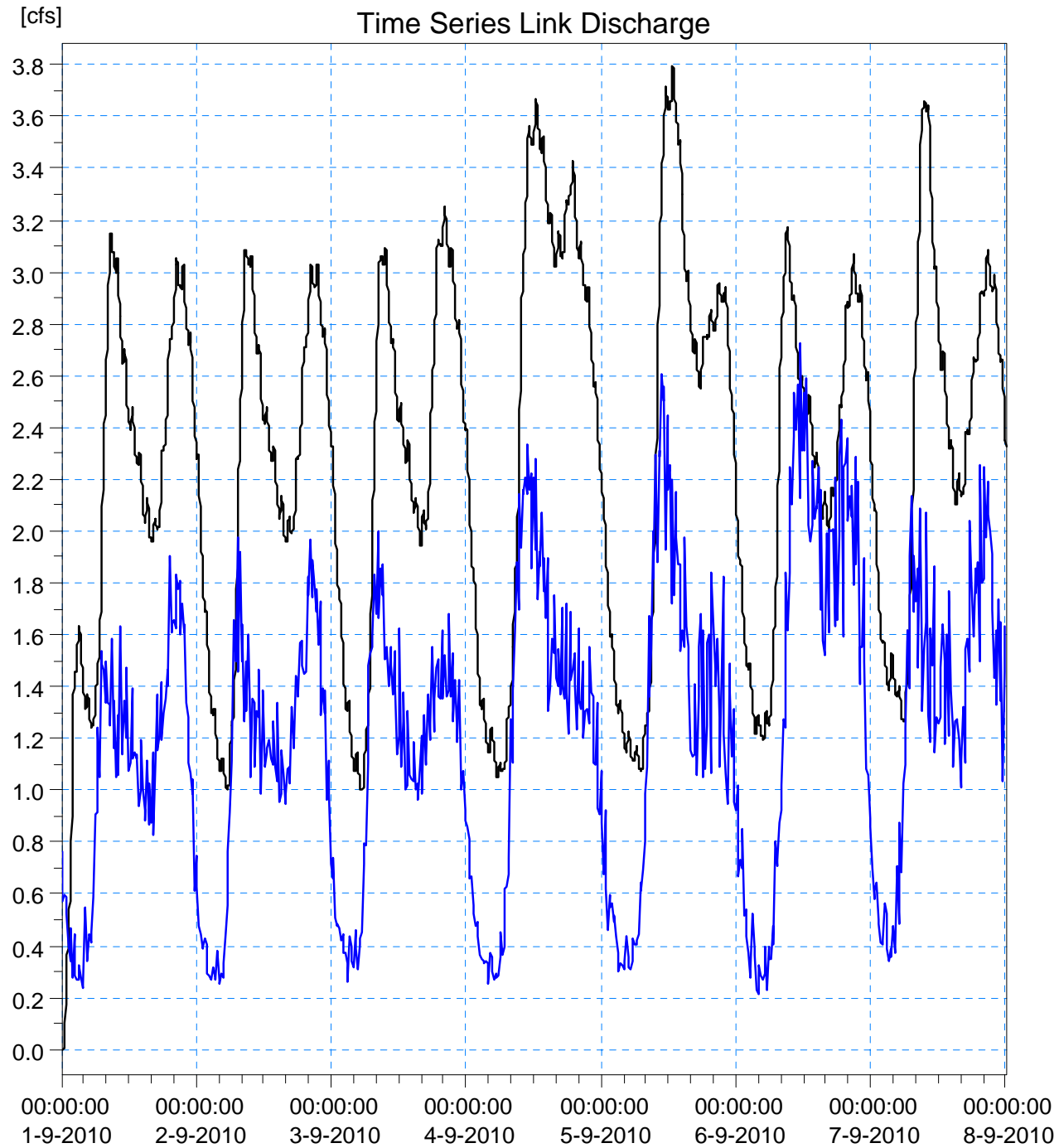

Link Discharge (Model Output)
— GM03057 (MH2009 -> MH2014) 82.81

External TS 1 (Flow Monitor Data)
— RNT 47 Dry

Note: Basin 30B flows into Basin 47. There were inconsistencies between the data of the two flow monitors.

Dry Calibration - SRENT002

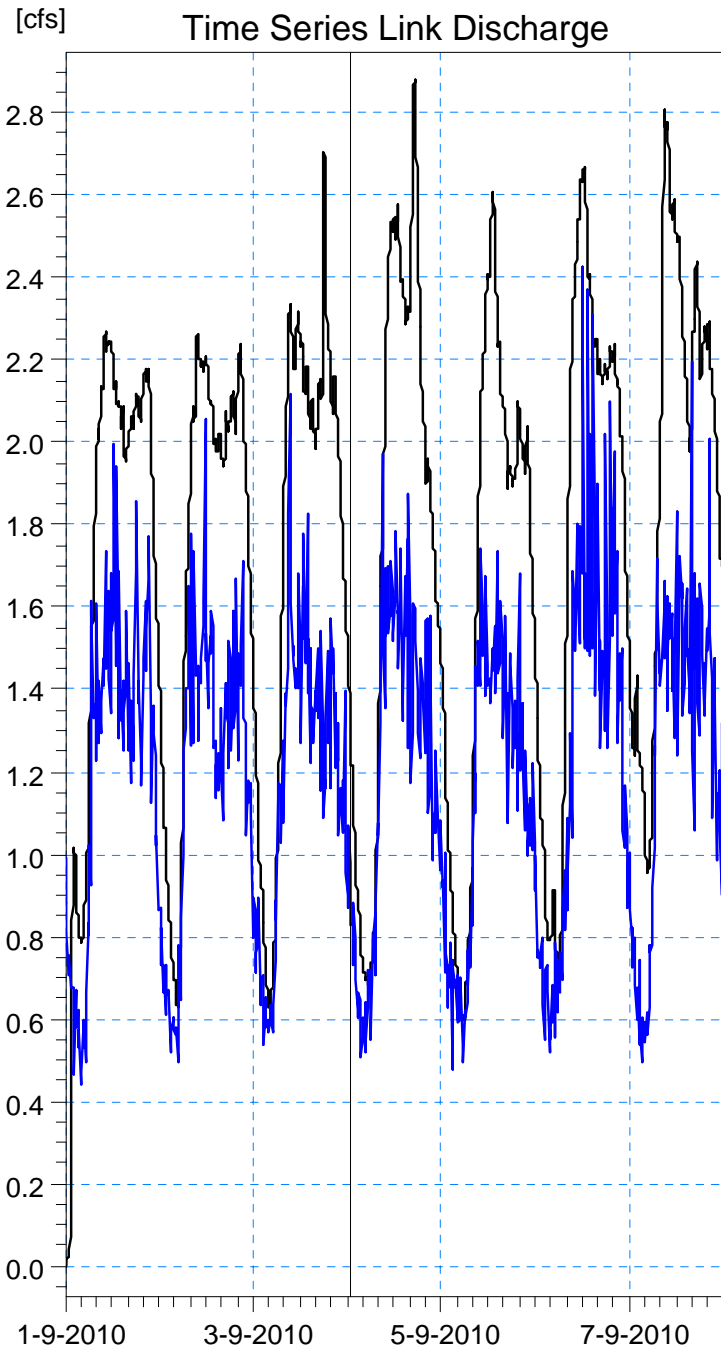

Link Discharge (Model Output)

— RE*SRENTON.R18-0311 (RE*SRENTON.R18-03 -> RE*SRENTON.R18-02) 98.66

External TS 1 (Flow Monitor Data)

— SRENT002 Dry

Note: Calibration is conservative. Per capita flow rates were lowered significantly from previous (2005) calibration.

APPENDIX B – Wet Weather Flow Calibration Time Series

Wet Calibration - Model Basin 17

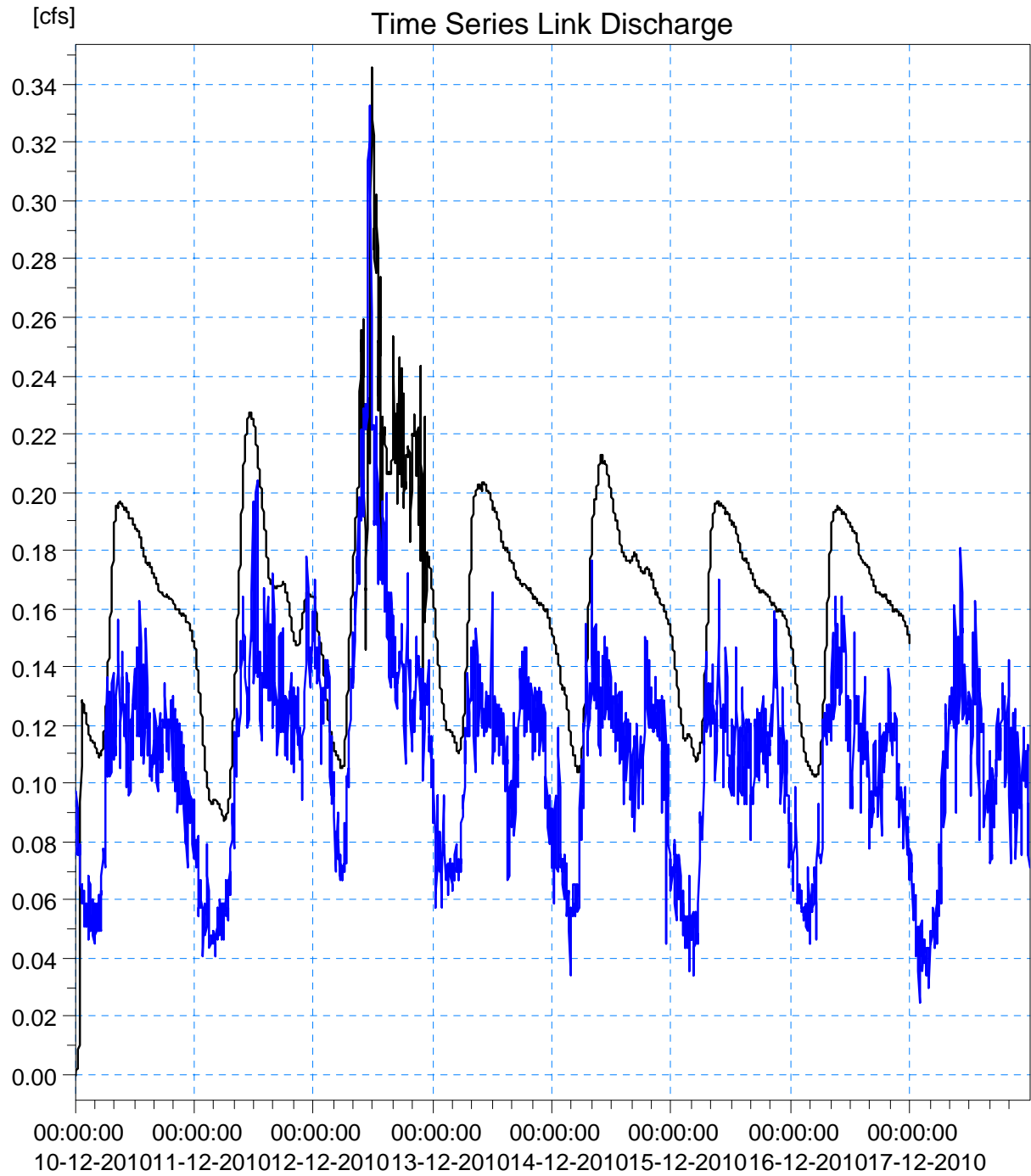

Link Discharge (Model Output)
— GM02800 (MH1852 -> MH1851) 120.91
External TS 1 (Flow Monitor Data)
— RNT017

Wet Calibration - Model Basin 23

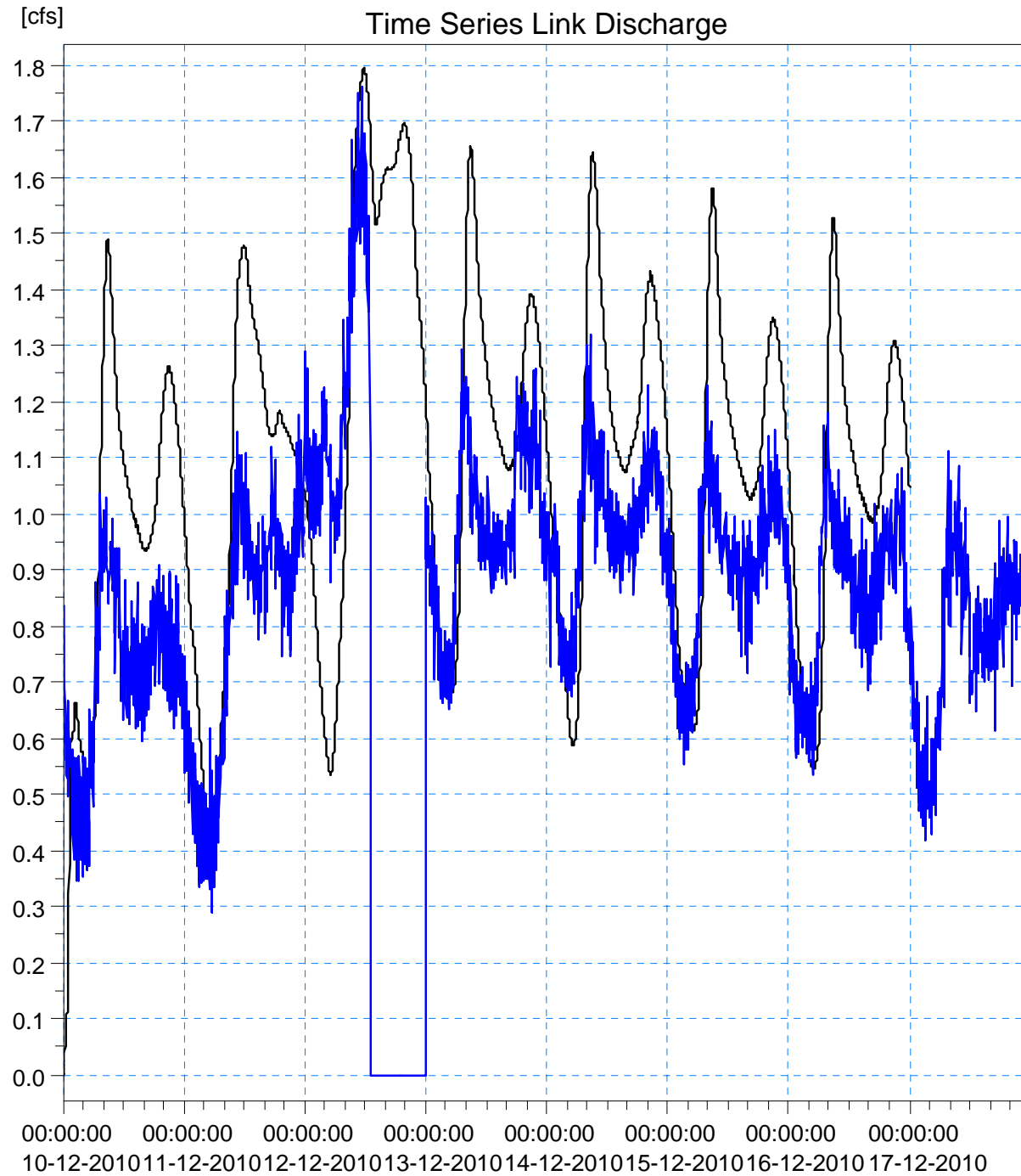

Link Discharge (Model Output)
— GM01571 (MH0520 -> MH0383) 24.48

External TS 1 (Flow Monitor Data)
— RNT023

Wet Calibration - Model Basin 25

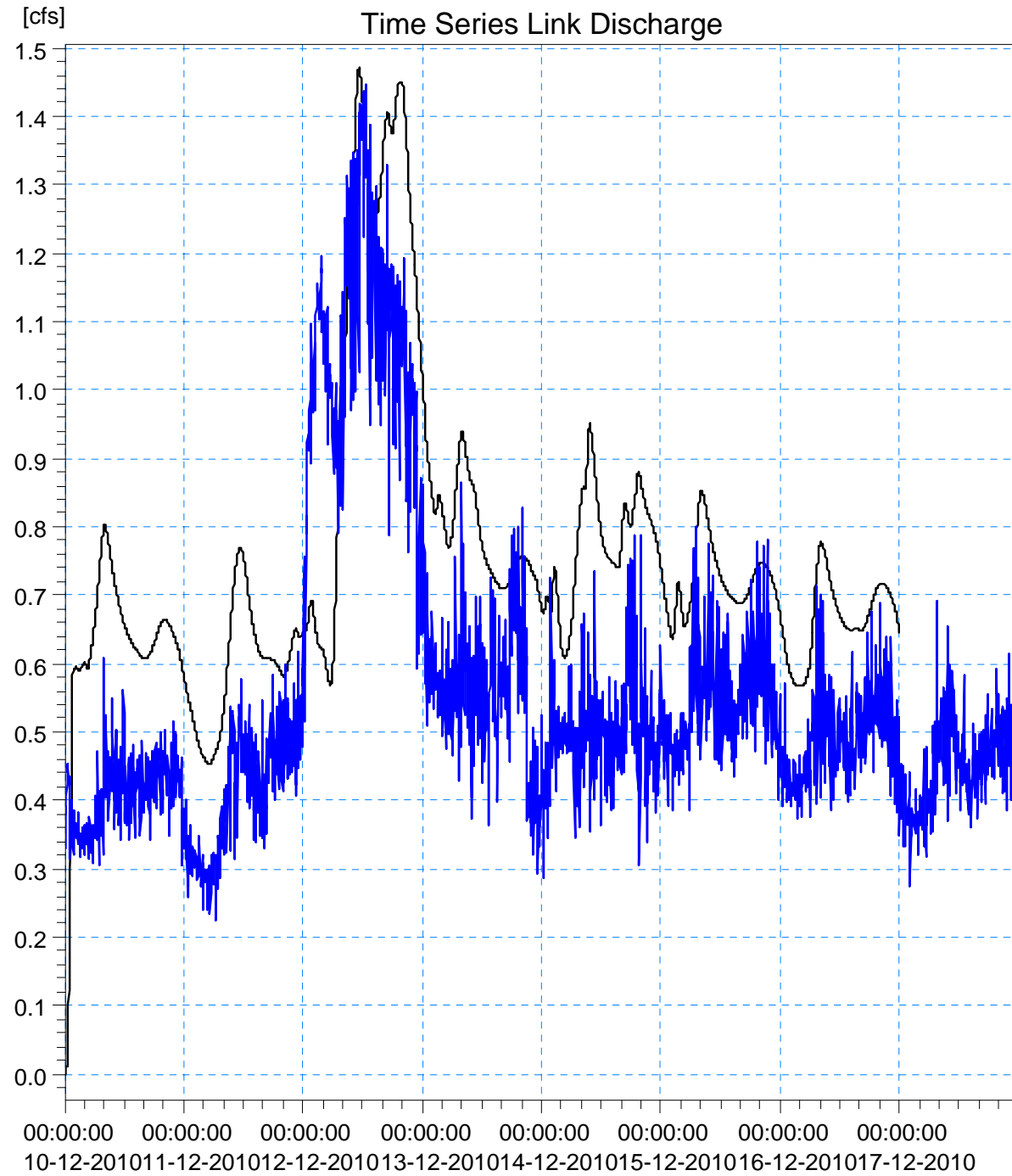

Link Discharge (Model Output)
— GM02237 (MH1773 -> MH1156) 109.94

External TS 1 (Flow Monitor Data)
— RNT025

Wet Calibration - Model Basin 28

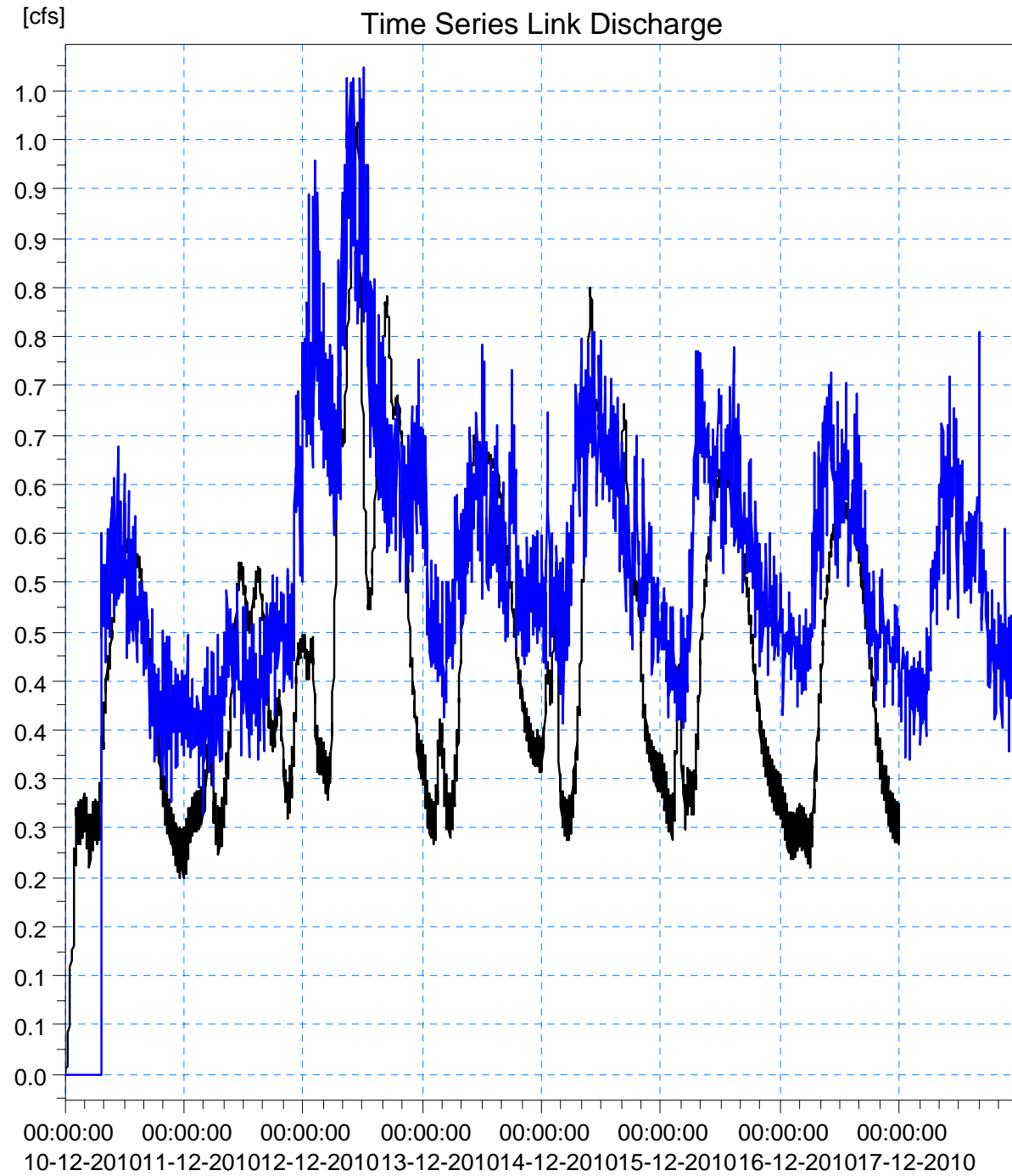

Link Discharge (Model Output)
— GM00108 (MH0206 -> MH0205) 108.45

External TS 1 (Flow Monitor Data)
— RNT028

Wet Calibration - Model Basin 30A

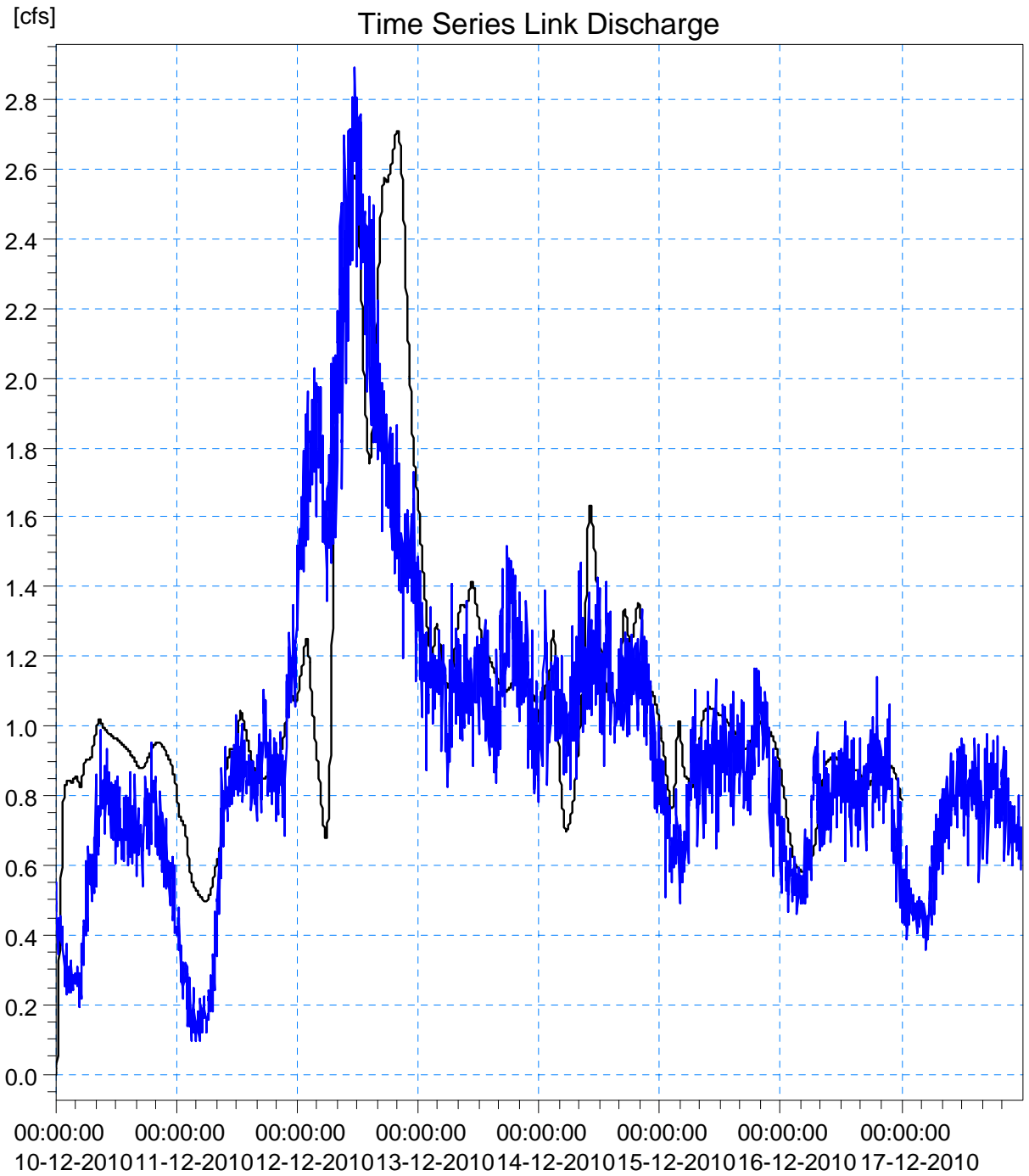

Link Discharge (Model Output)
— GM01793 (MH0715 -> MH0714) 90.57

External TS 1 (Flow Monitor Data)
— RNT030A

Wet Calibration - Model Basin 30B

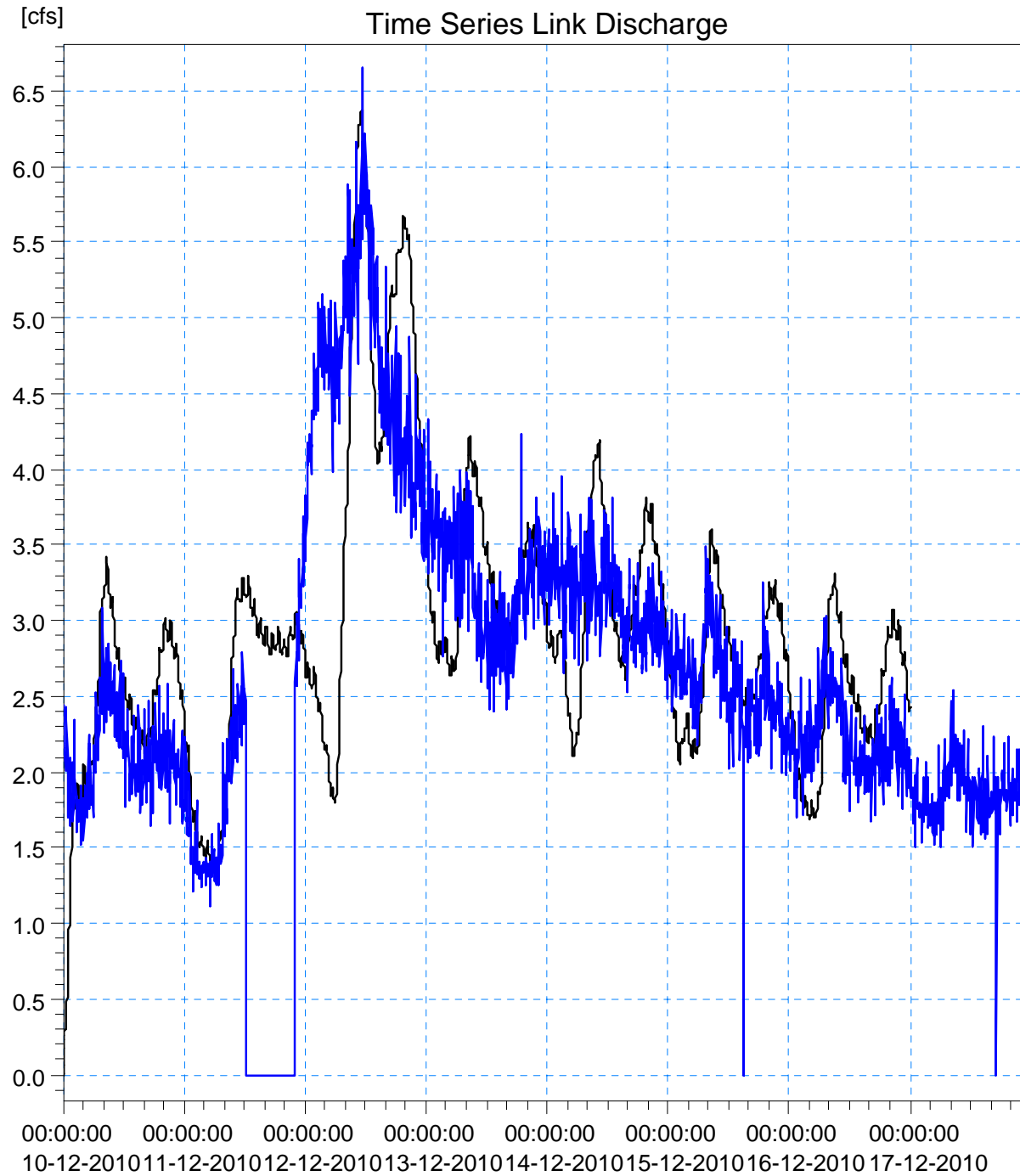

Link Discharge (Model Output)

— GM04481 (MH4653 -> MH4652) 99.98

External TS 1 (Flow Monitor Data)

— RNT030B

Note: Basin 30B flows into Basin 47. There were inconsistencies between the data of the two flow monitors.

Wet Calibration - Model Basin 35

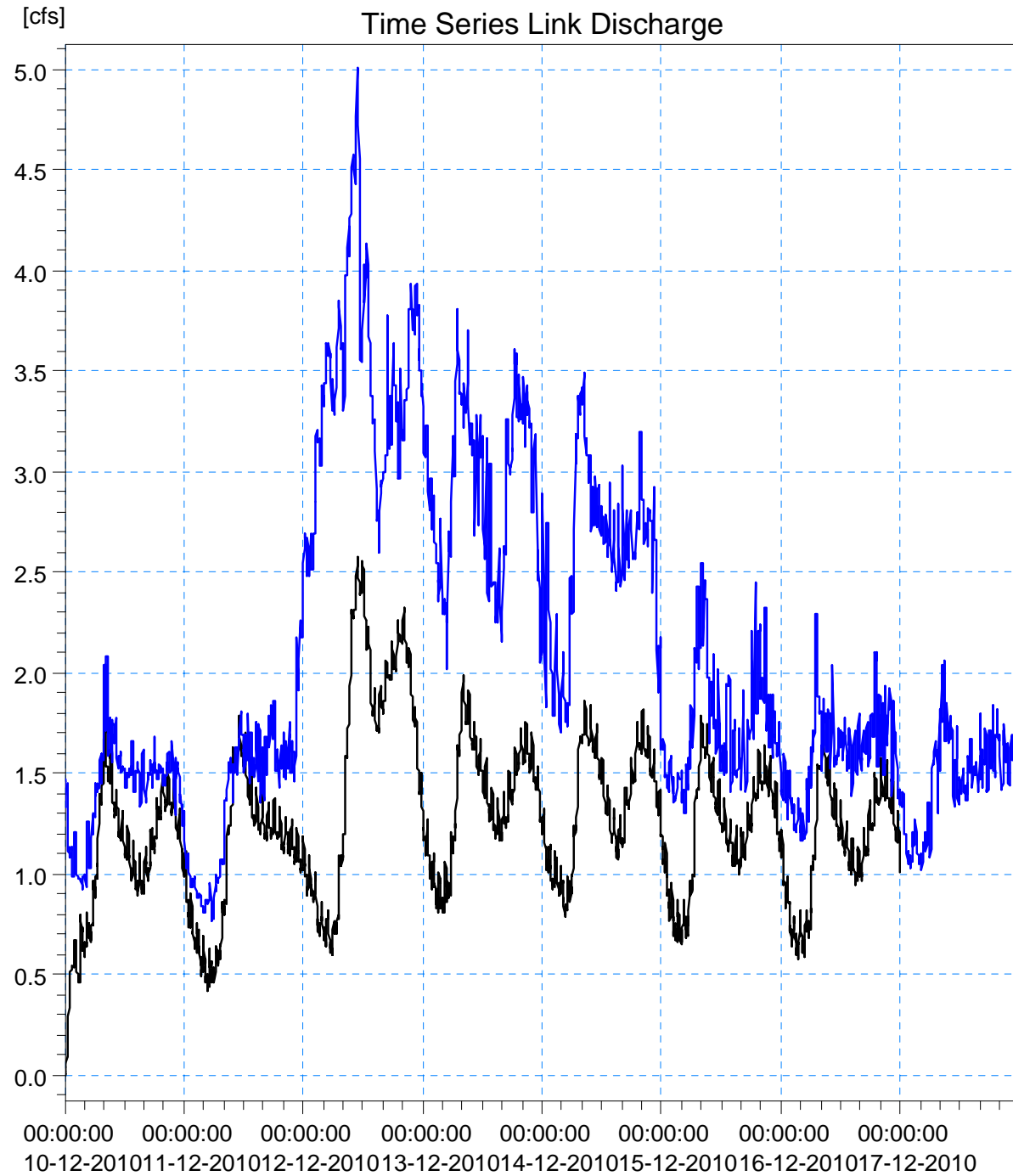

Link Discharge (Model Output)
— GM01350 (MH3756 -> MH0368) 113.70

External TS 1 (Flow Monitor Data)
— RNT035

Note: Per discussions with City,
no modifications were made
from previous (2005) RDII
parameters.

Wet Calibration - Model Basin 41

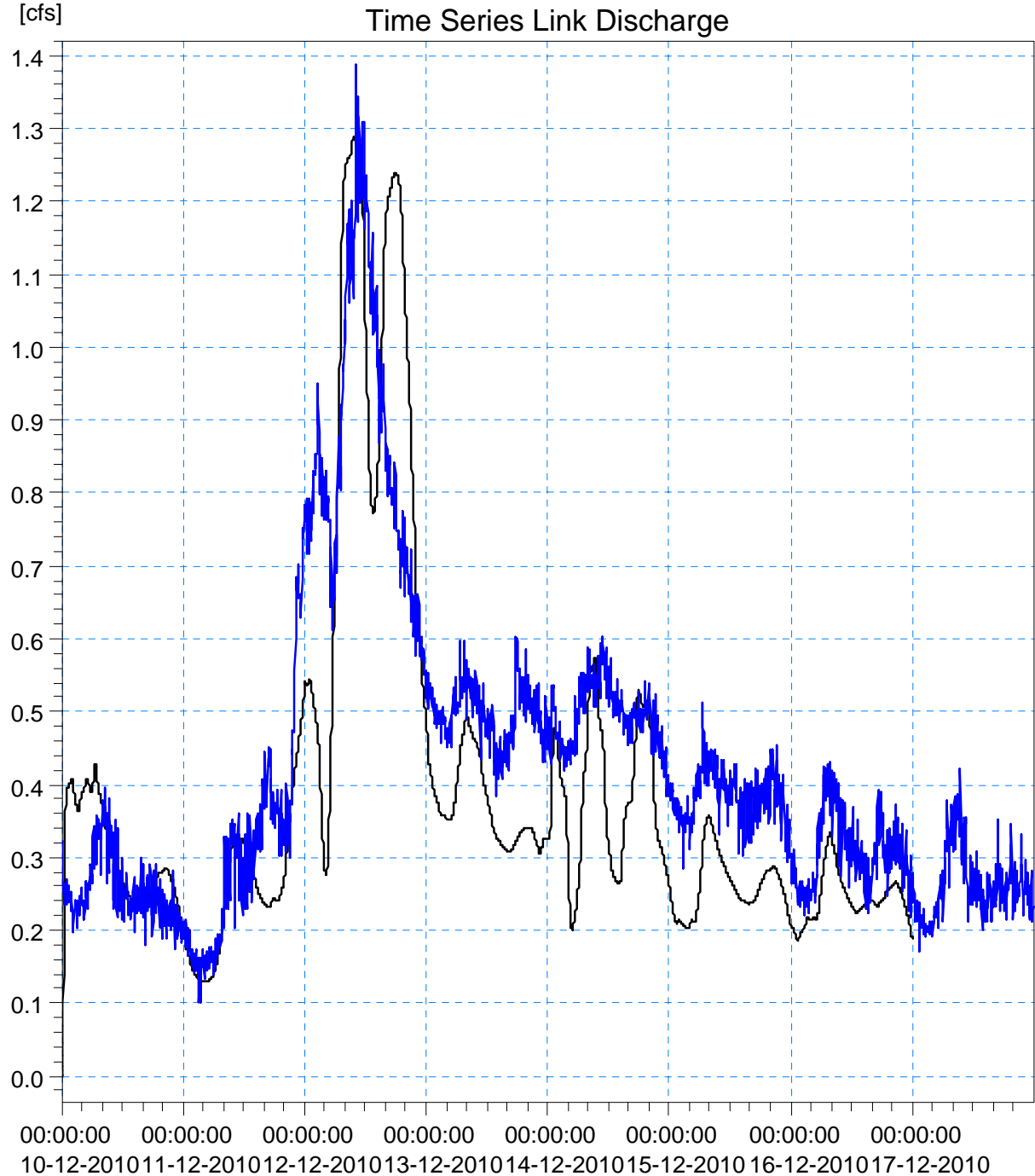

Link Discharge (Model Output)
— GM05921 (MH5705 -> MH3511) 83.15
External TS 1 (Flow Monitor Data)
— RNT041

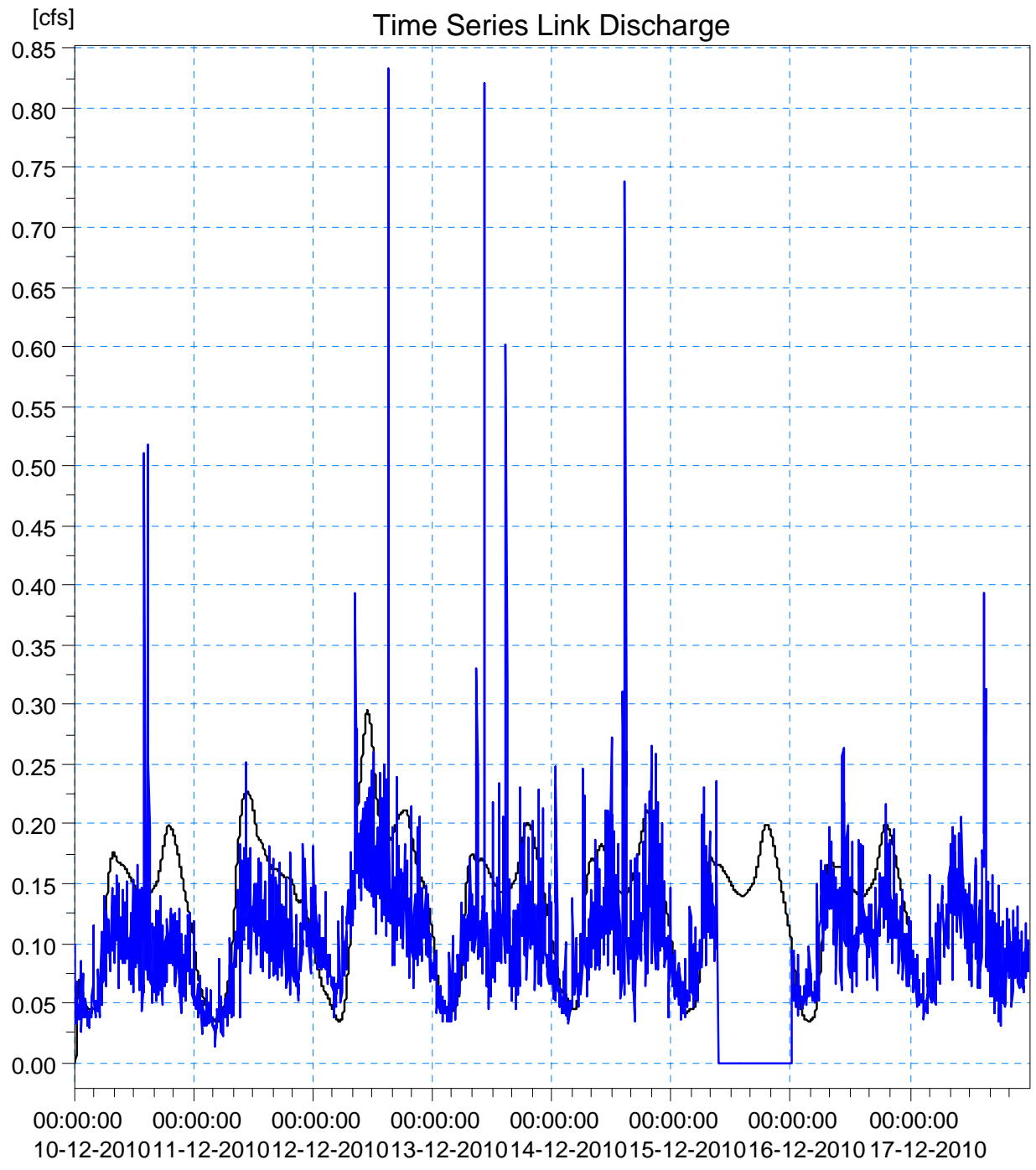

Link Discharge
— GM01059 (MH1205 -> MH1206) 79.00
External TS 1
— RNT043

Wet Calibration - Model Basin 47

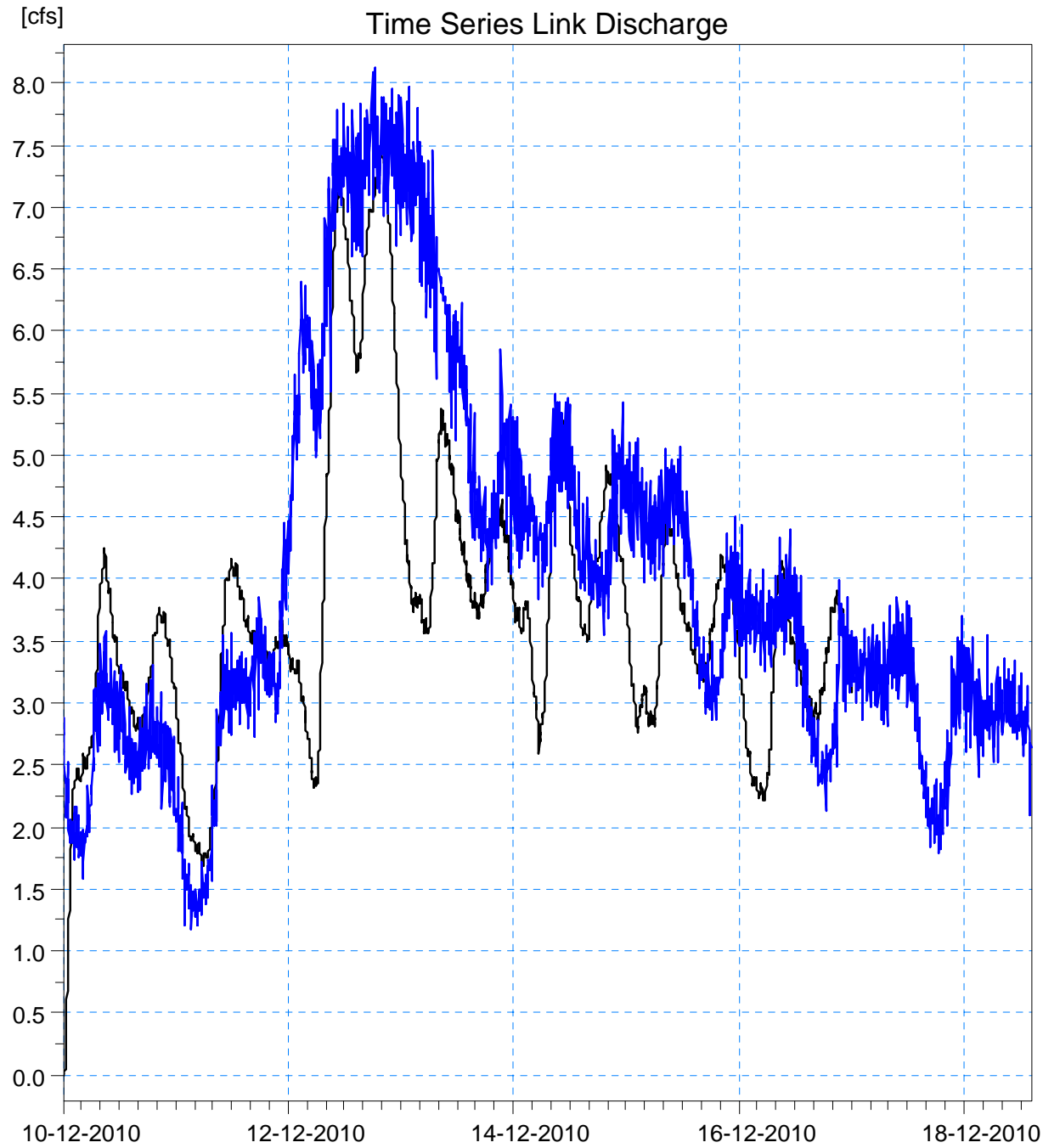

Link Discharge (Model Output)

— GM03057 (MH2009 -> MH2014) 82.81

External TS 1 (Flow Monitor Data)

— RNT047

Note: Basin 30B flows into Basin 47. There were inconsistencies between the data of the two flow monitors.

Wet Calibration - Model Basin 65

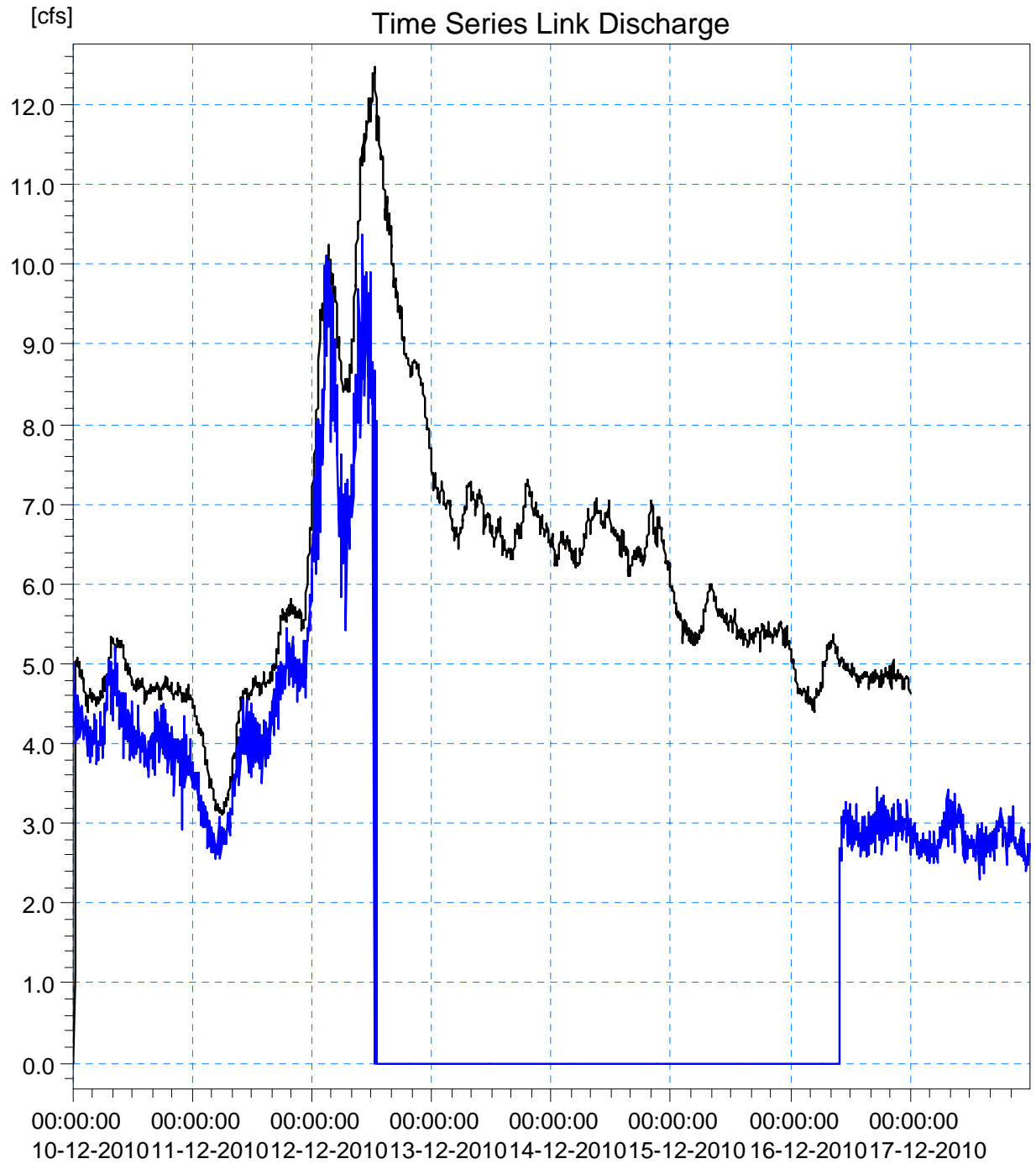

Link Discharge (Model Output)
— GM05309 (MH5303 -> MH5304) 33.19
External TS 1 (Flow Monitor Data)
— RENT65

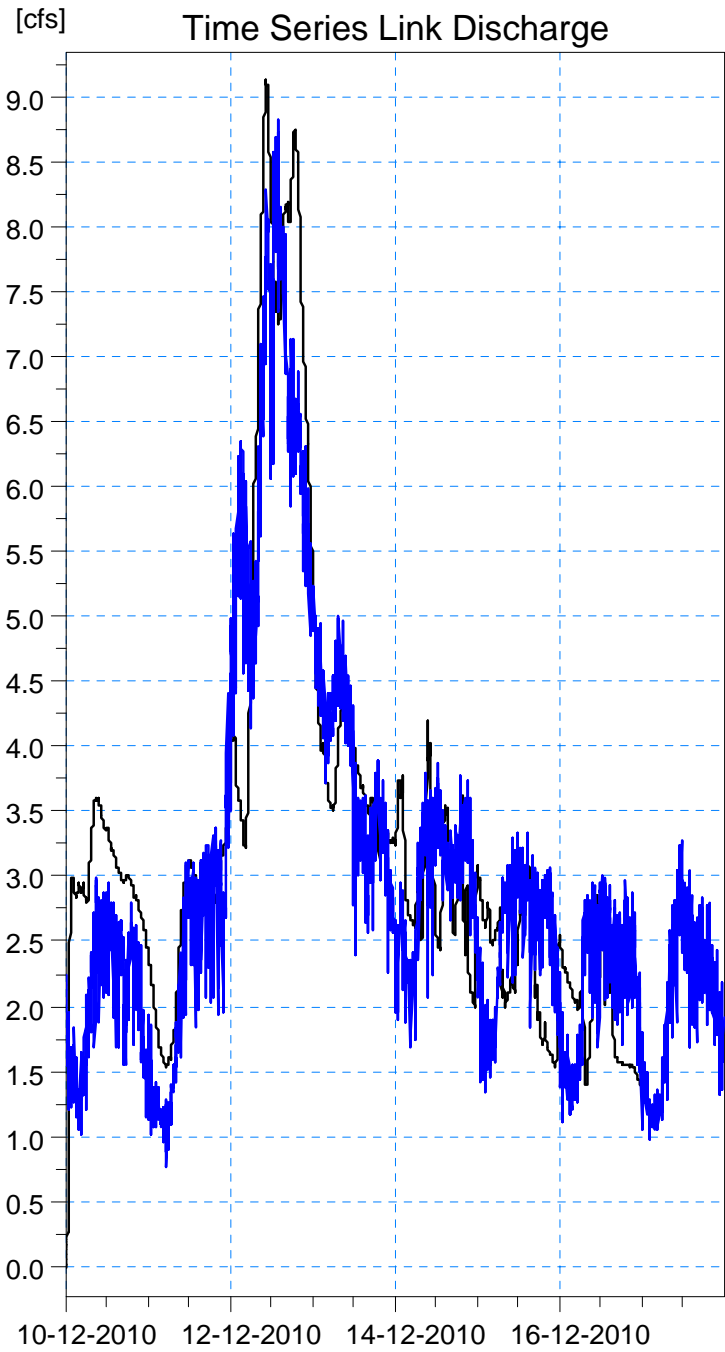

Link Discharge
— RE*SRENTON.R18-0311 (RE*SRENTON.R18-03 -> RE*SRENTON.R18-02) 98.66

External TS 1
— SRENT002

APPENDIX C –
Figure 5-2A through Figure 5-2S: 2012 Sewer Model Analysis Results

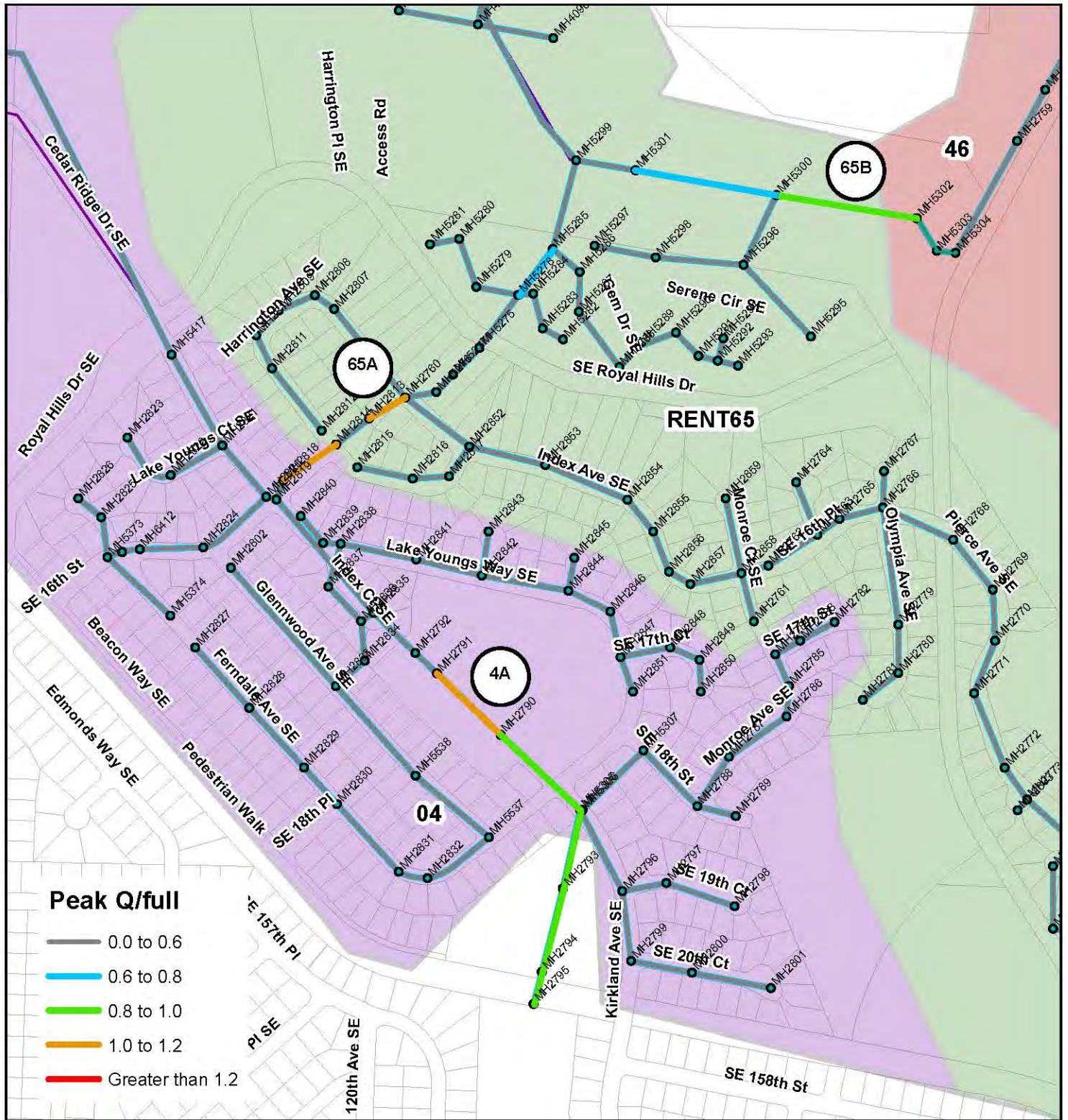
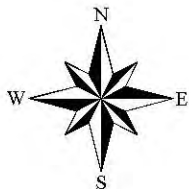

Figure 5-2A

City of Renton

2012 Sewer Model Analysis Results

Basin 4/Basin 65 Problem Areas



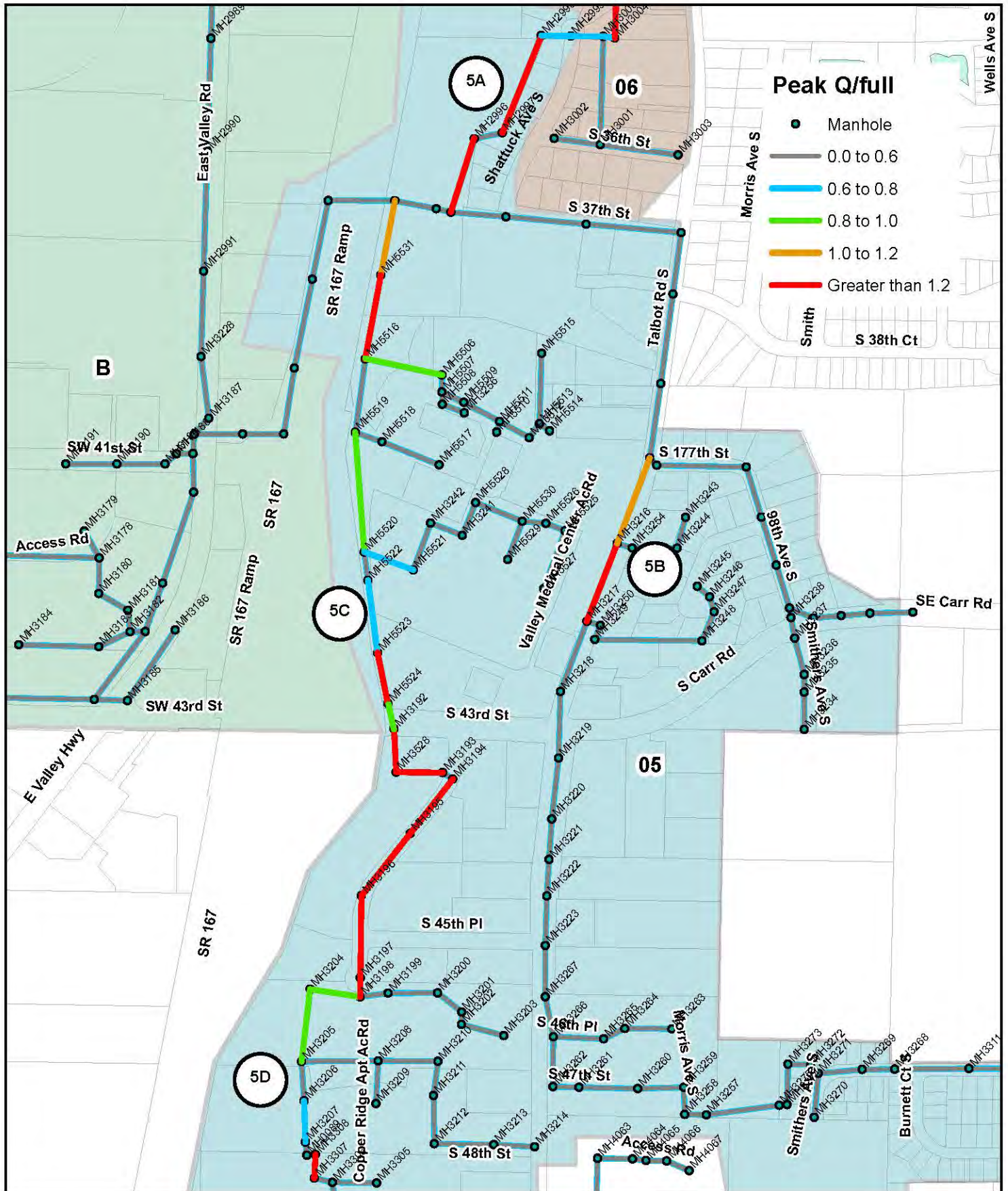
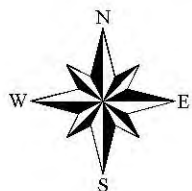

Figure 5-2B

City of Renton
2012 Sewer Model Analysis Results

Basin 5 Problem Areas



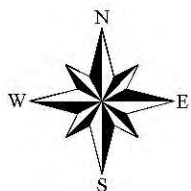
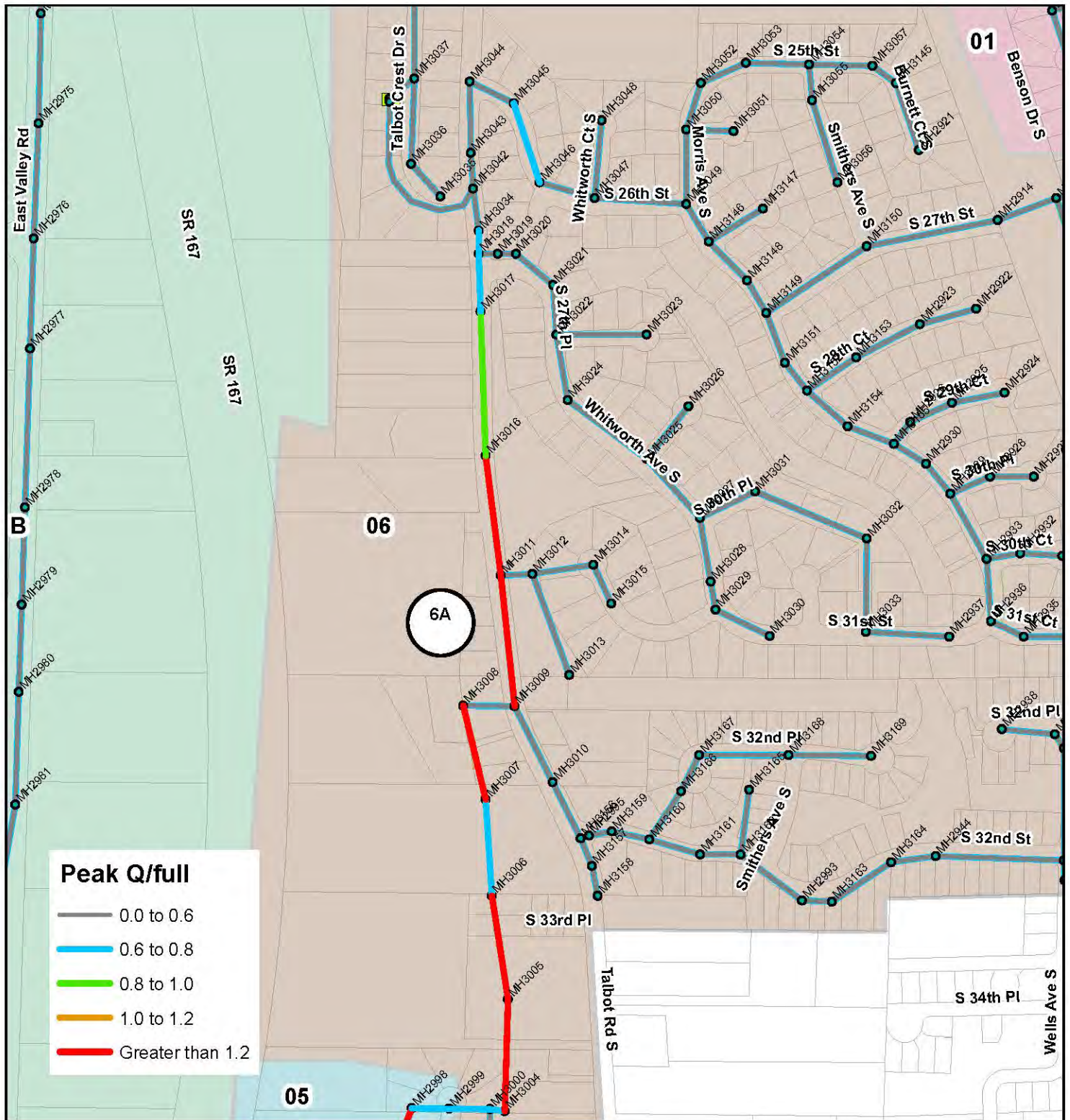

Figure 5-2C

City of Renton
2012 Sewer Model Analysis Results

Basin 6 Problem Areas



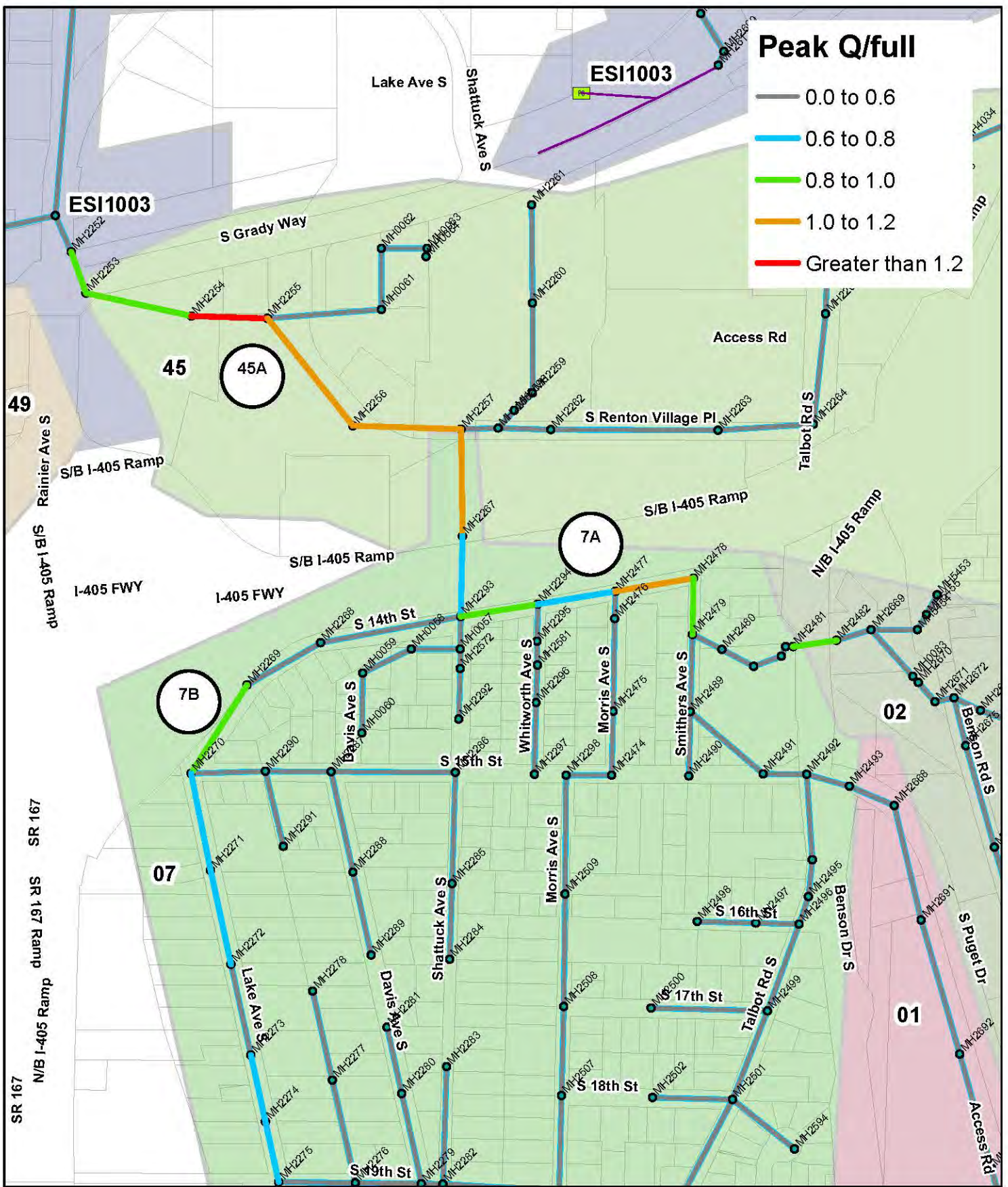
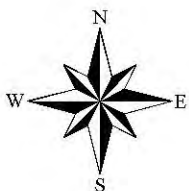

Figure 5-2D

City of Renton
 2012 Sewer Model Analysis Results
 Basin 7 and Basin 45 Problem Areas



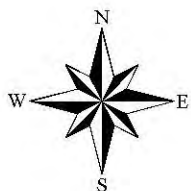
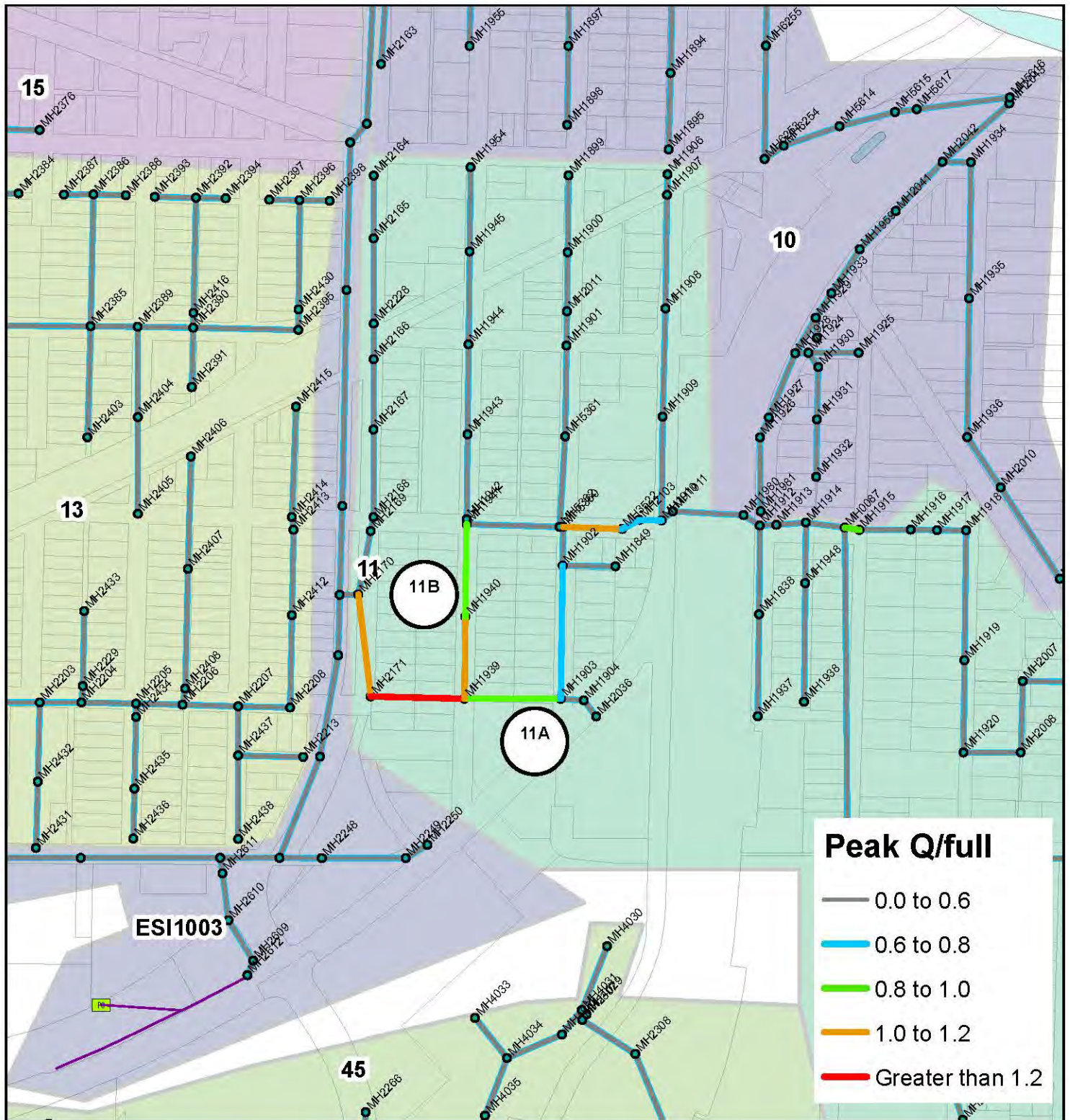

Figure 5-2E

City of Renton
2012 Sewer Model Analysis Results

Basin 11 Problem Areas



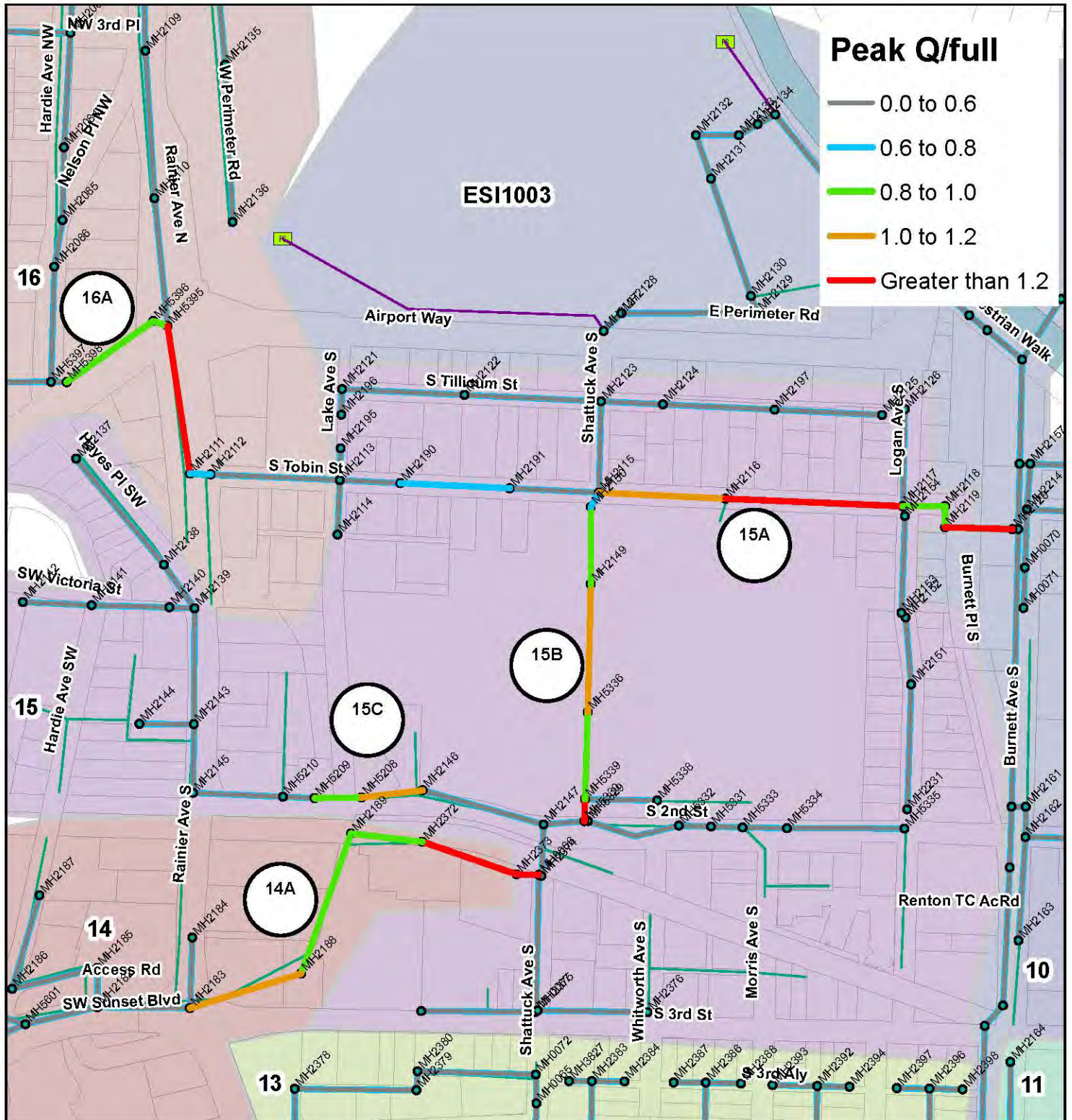
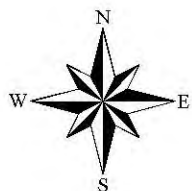

Figure 5-2F

City of Renton
2012 Sewer Model Analysis Results

Basin 14, Basin 15, and Basin 16 Problem Areas



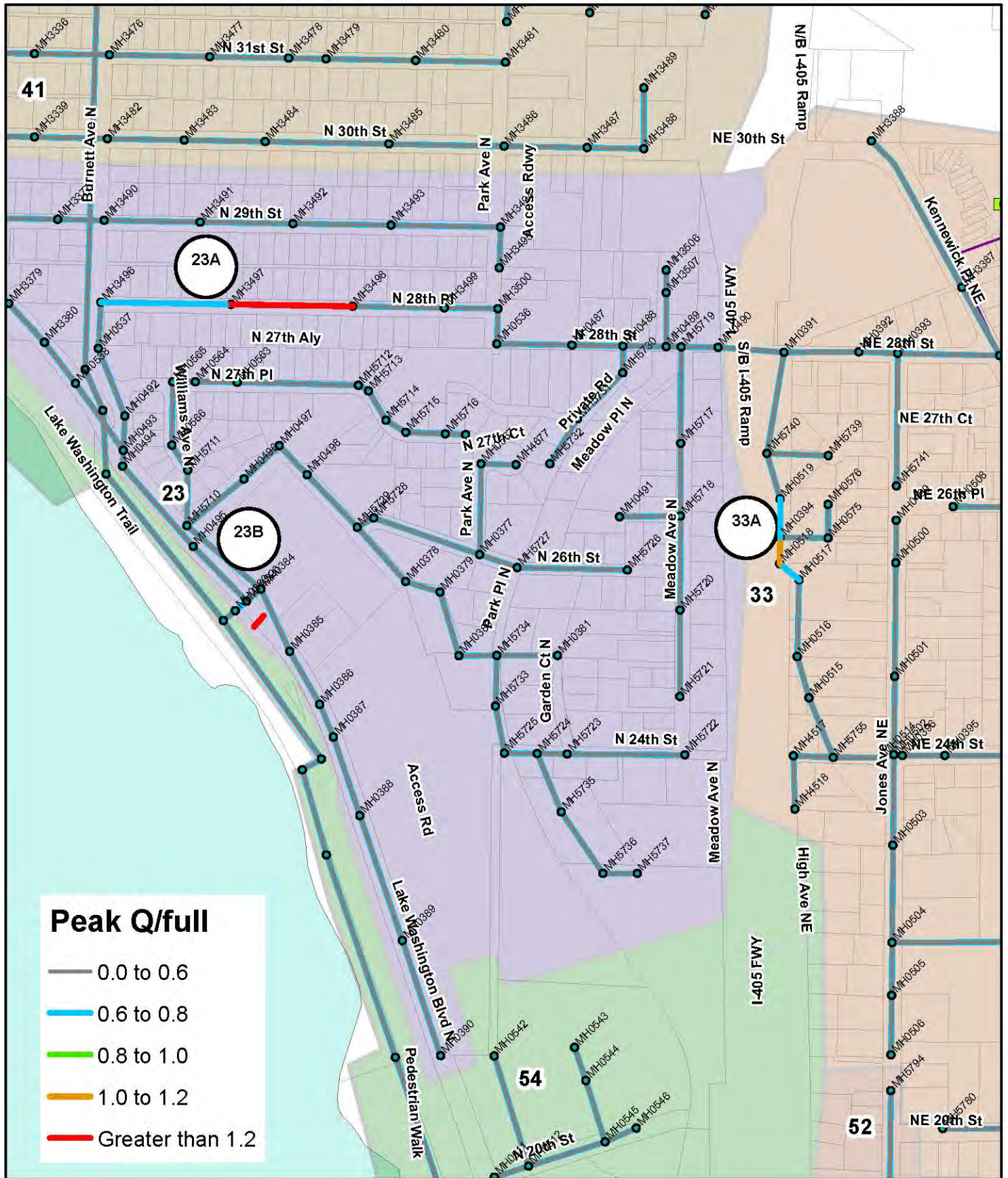

Figure 5-2H

City of Renton
2012 Sewer Model Analysis Results

Basin 23 and Basin 33 Problem Areas



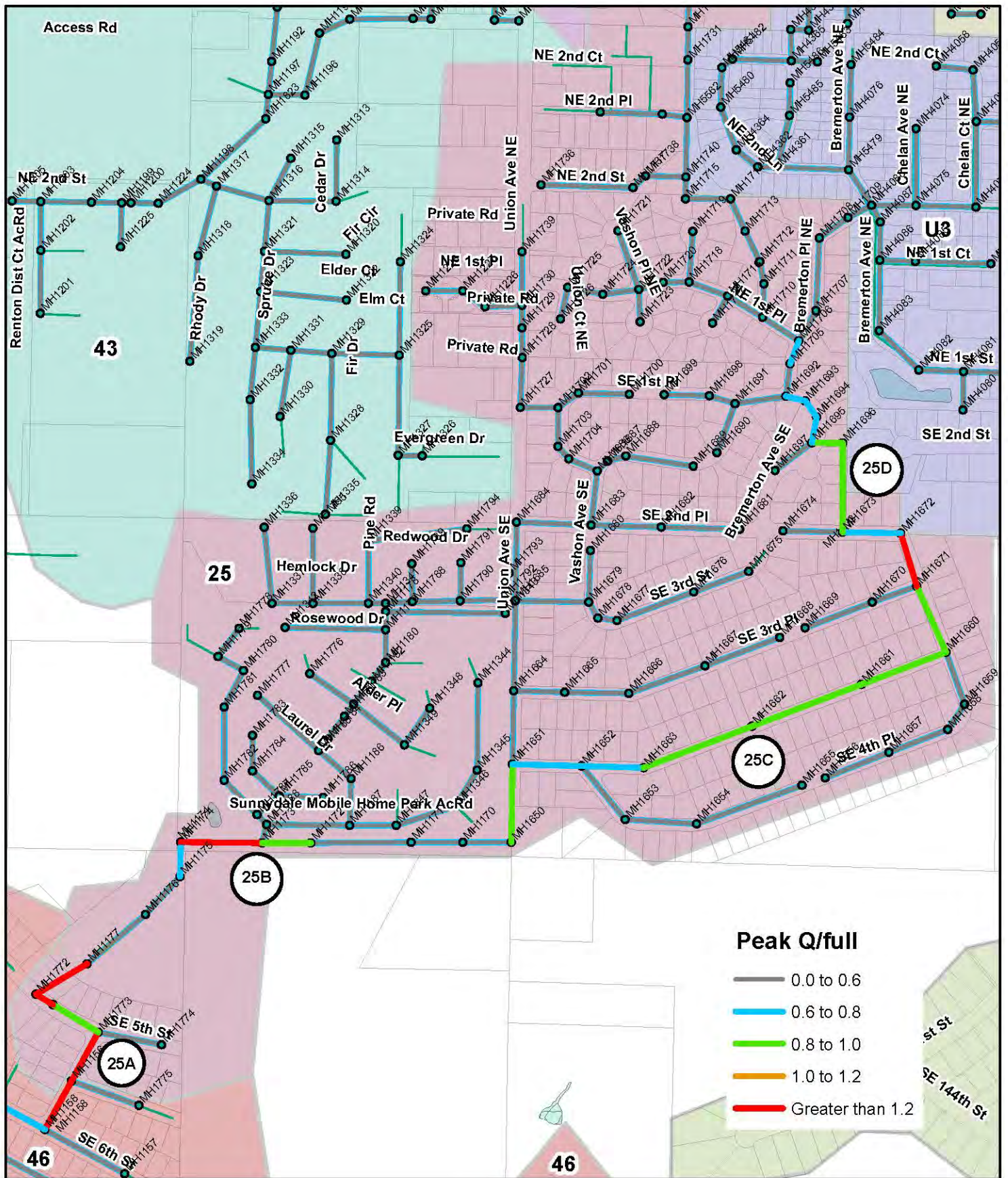
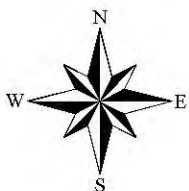

Figure 5-21

City of Renton
2012 Sewer Model Analysis Results

Basin 25 Problem Areas



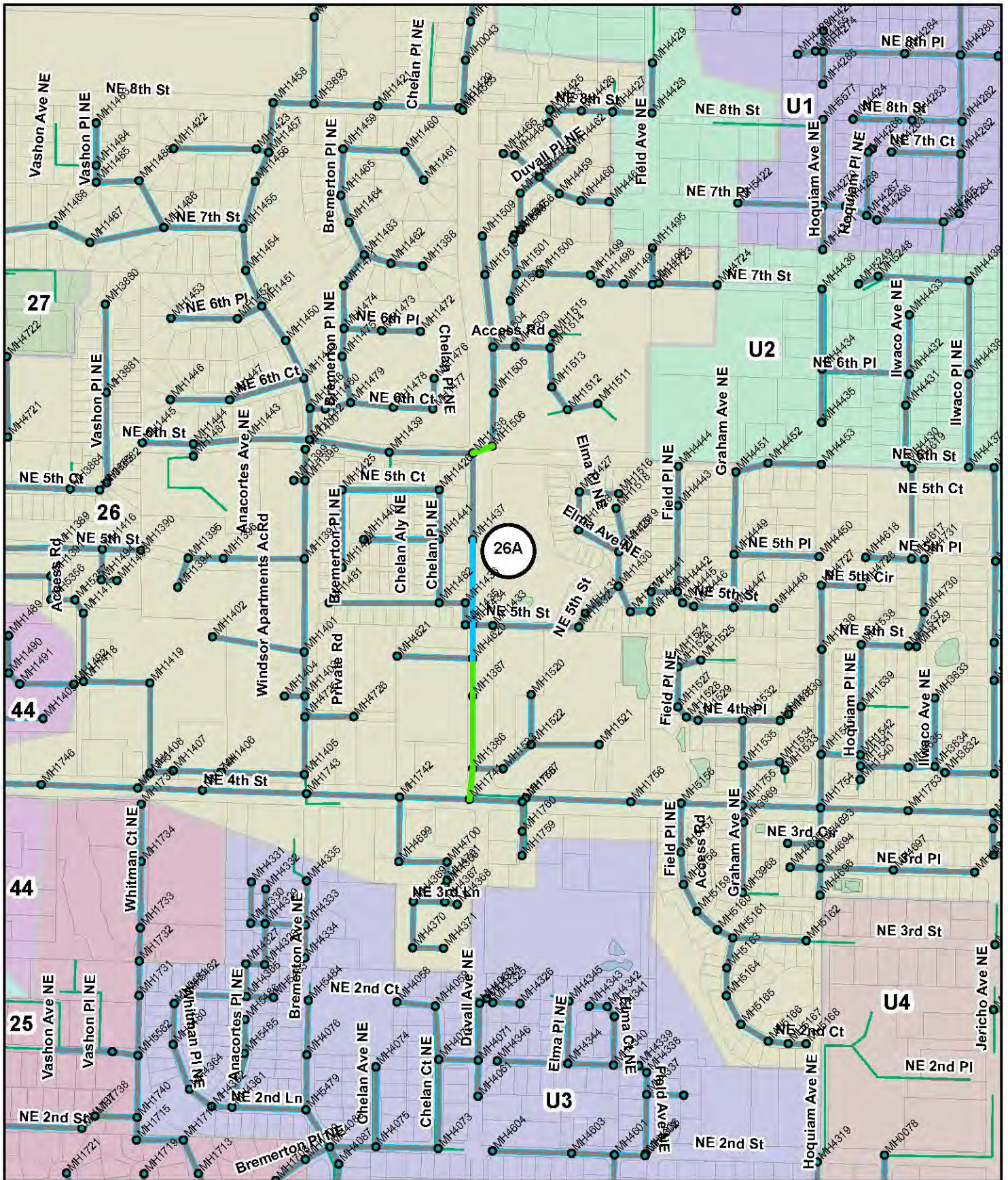
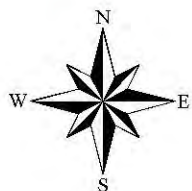

Figure 5-2J

City of Renton
2012 Sewer Model Analysis Results

Basin 26 Problem Areas



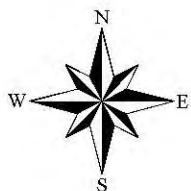
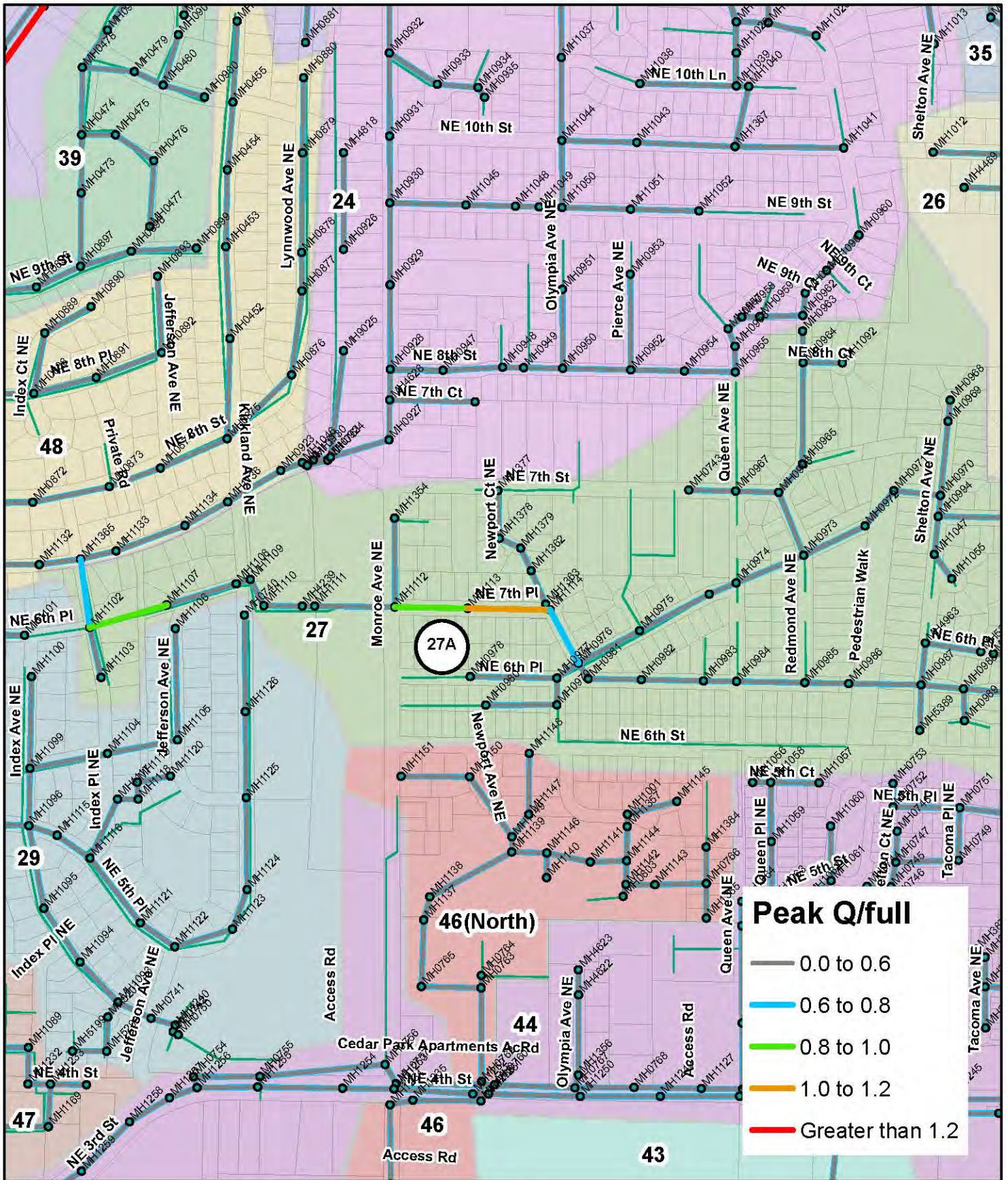

Figure 5-2K

City of Renton
2012 Sewer Model Analysis Results

Basin 27 Problem Areas



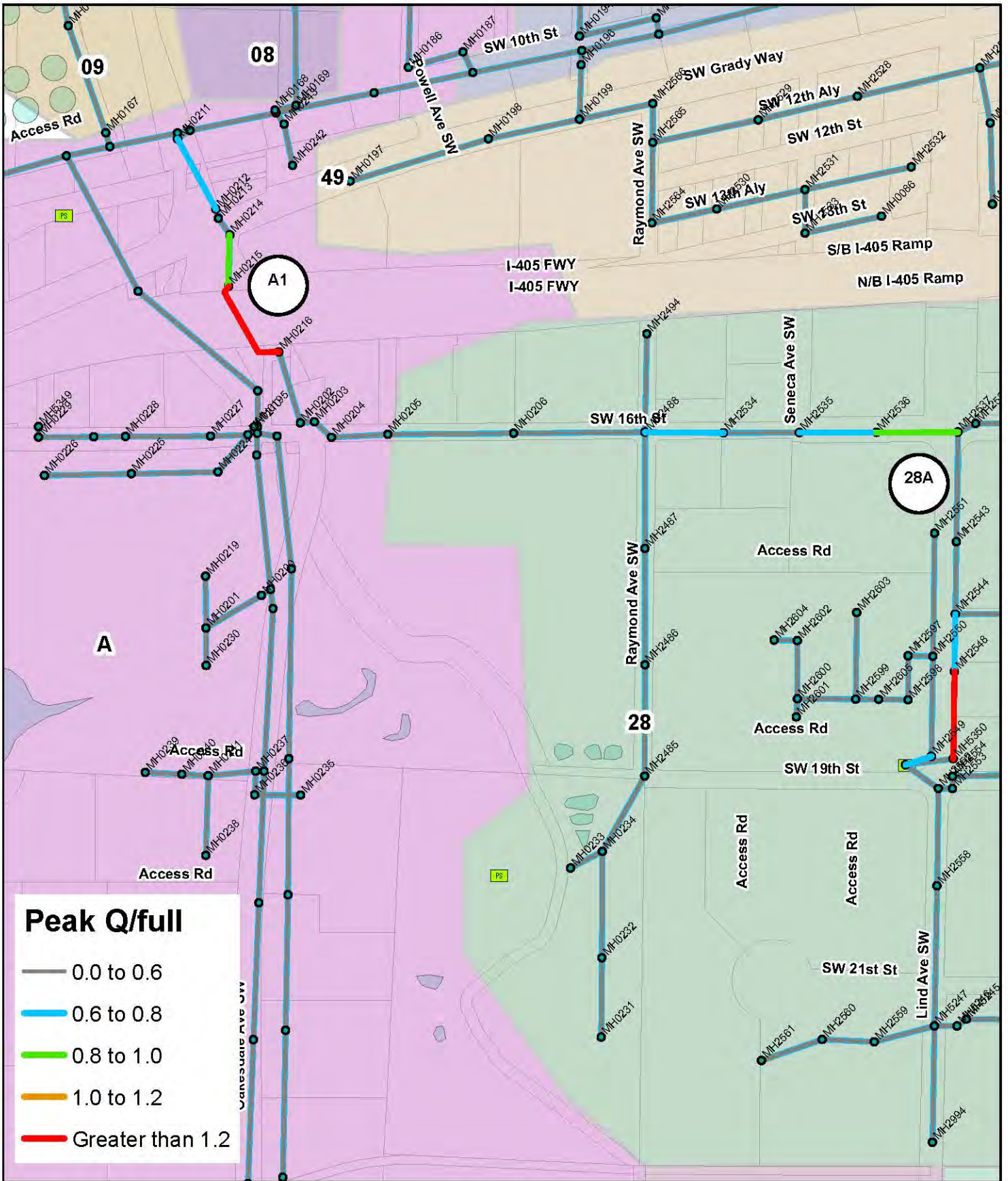
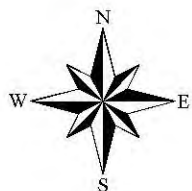

Figure 5-2L

City of Renton
2012 Sewer Model Analysis Results

Basin 28 and Basin A (North) Problem Areas



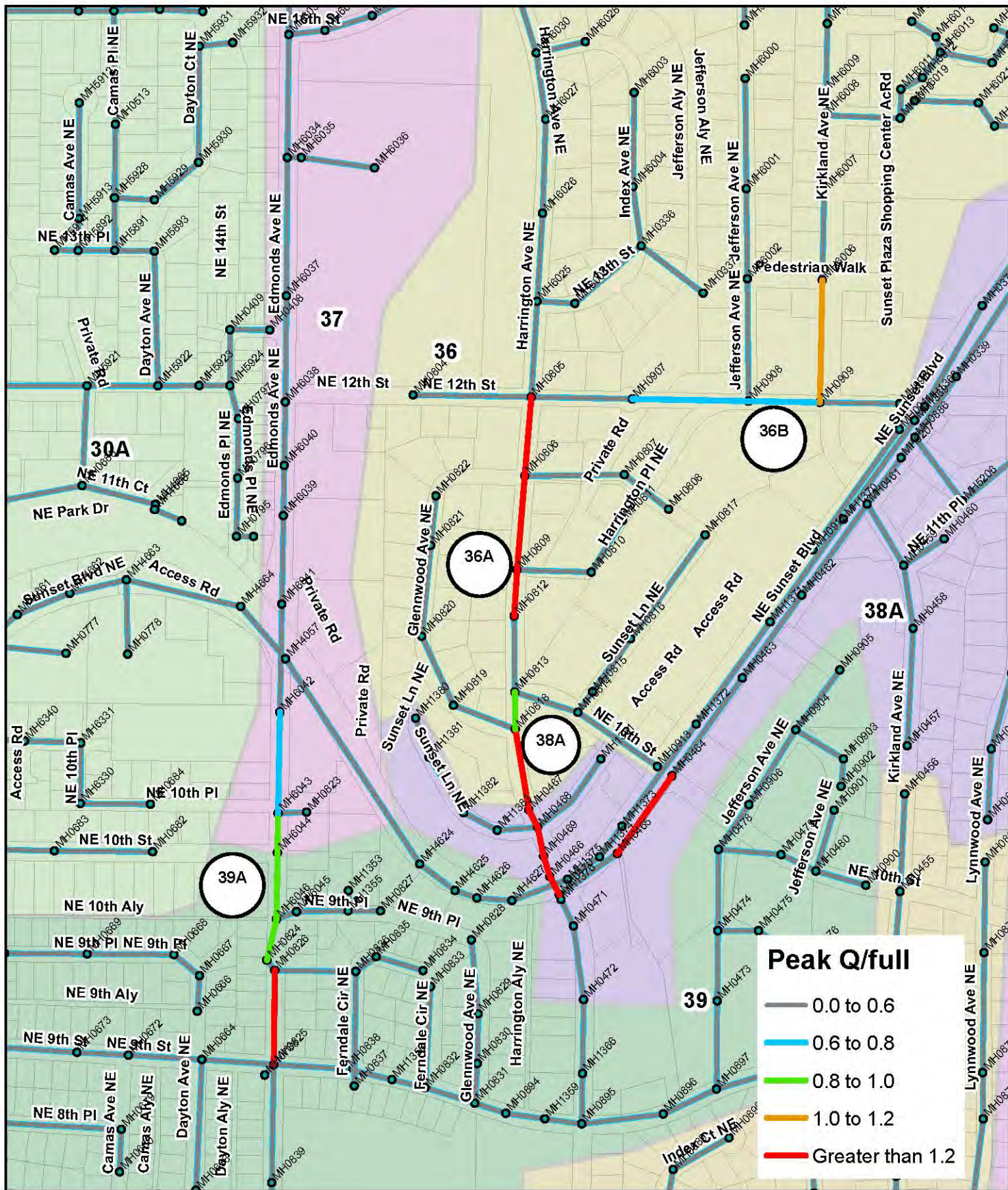
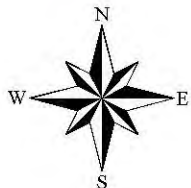

Figure 5-2M

City of Renton
2012 Sewer Model Analysis Results



Basin 36, Basin 38, & Basin 39 Problem Areas



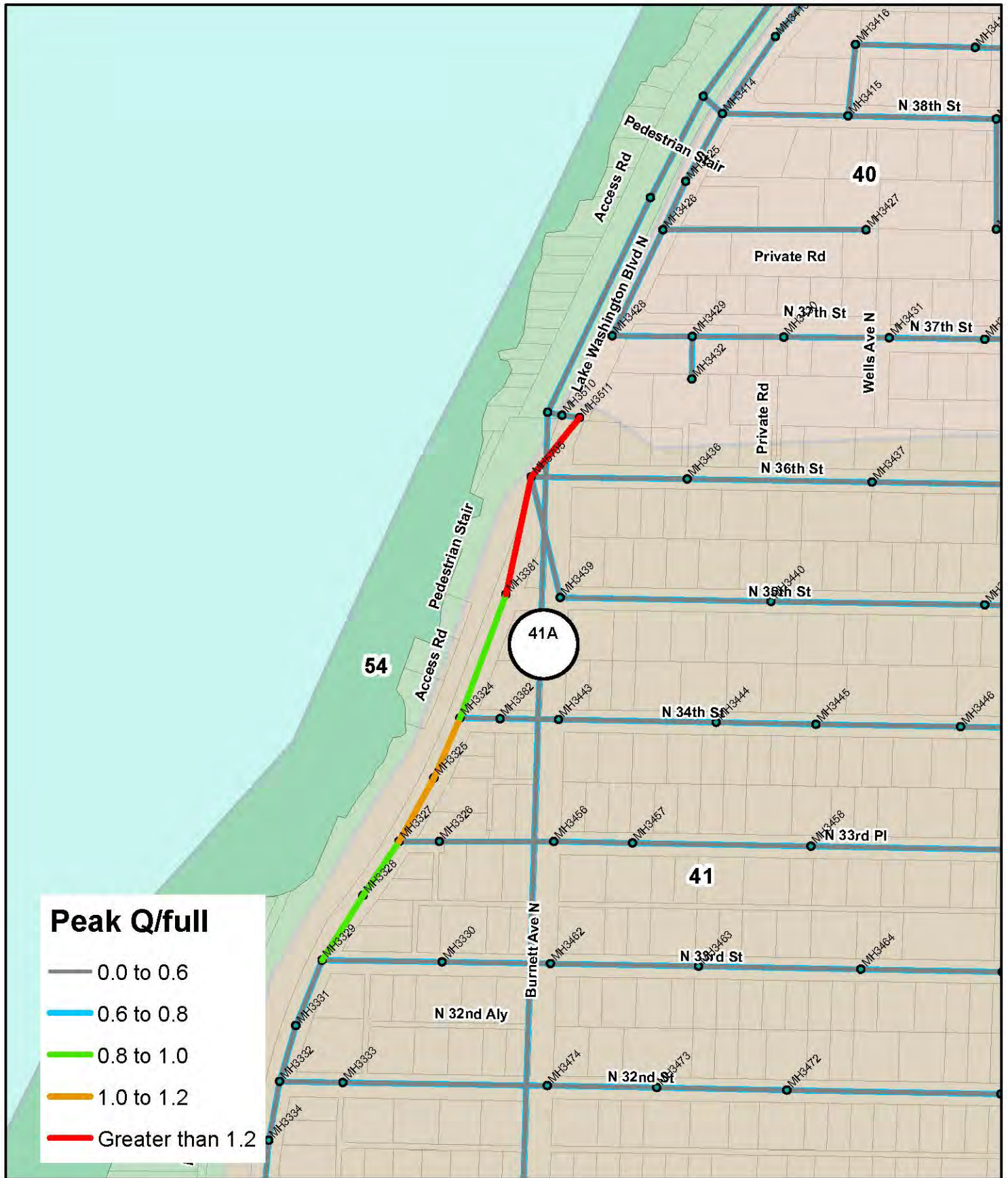
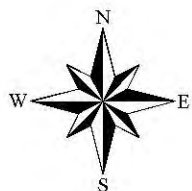

Figure 5-2N

City of Renton
2012 Sewer Model Analysis Results

Basin 41 Problem Areas



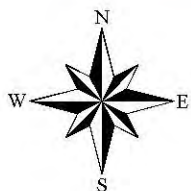
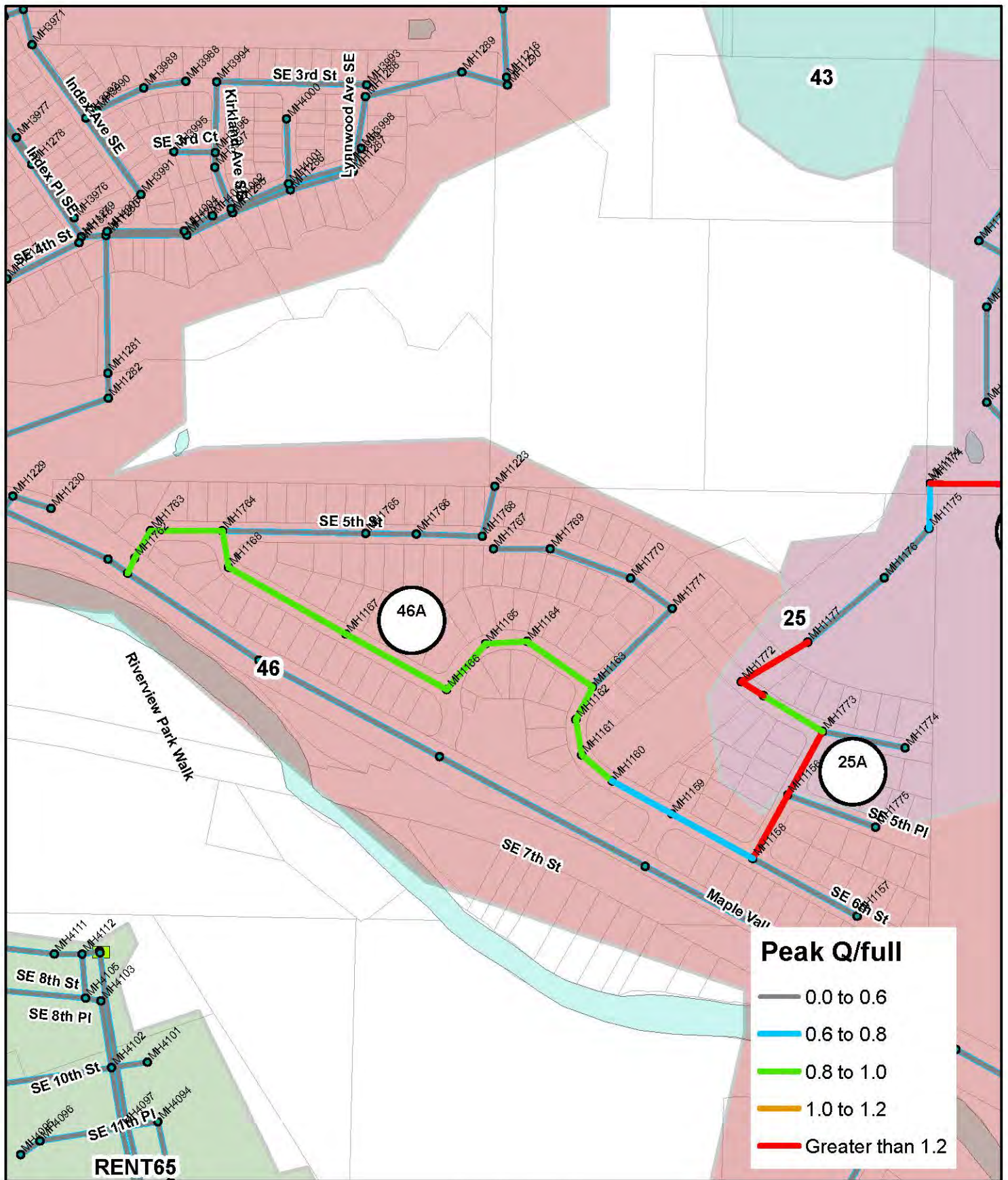

Figure 5-20

City of Renton
2012 Sewer Model Analysis Results

Basin 46 Problem Areas



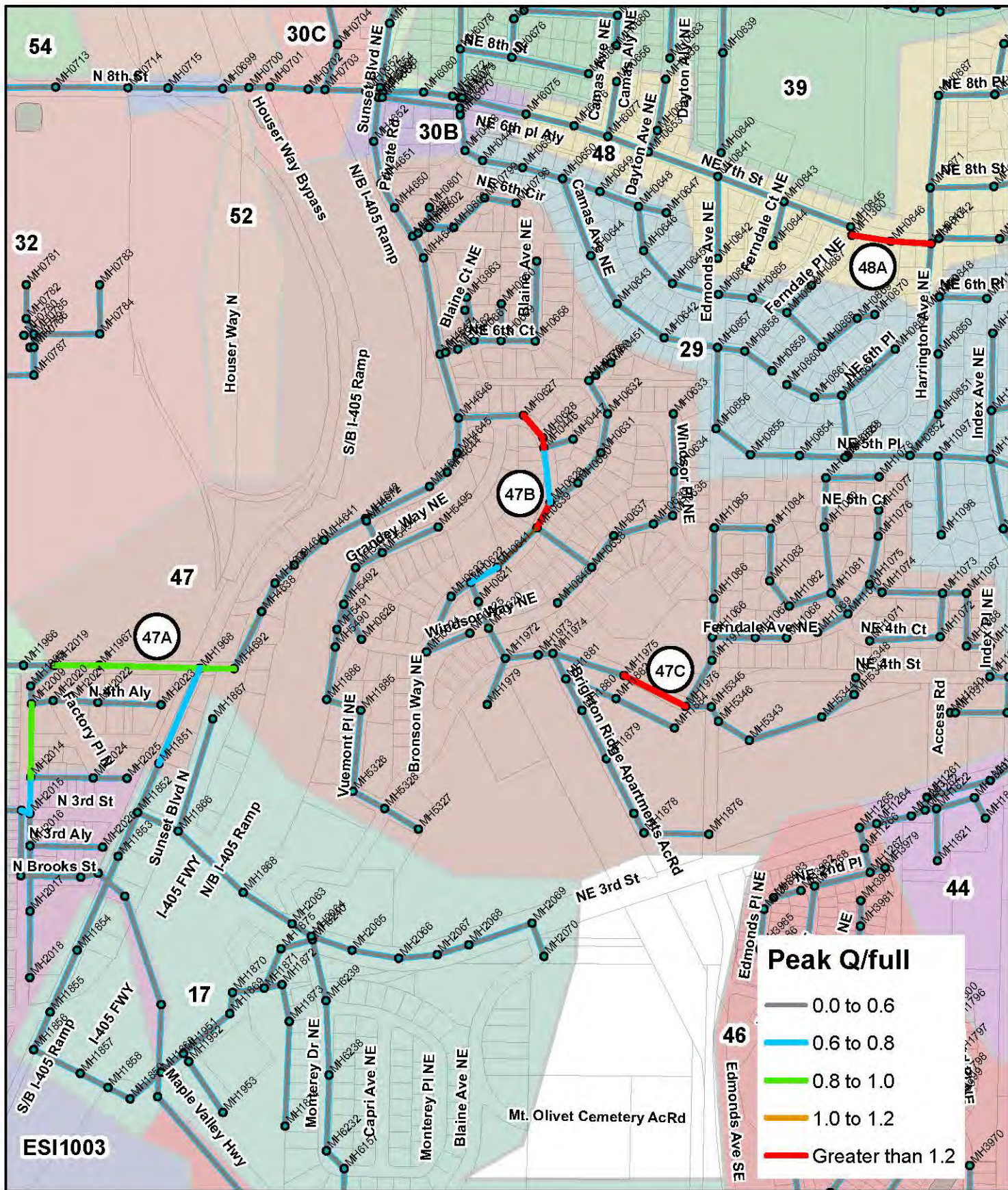
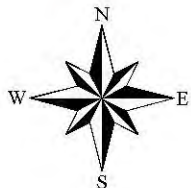

Figure 5-2P

City of Renton
2012 Sewer Model Analysis Results

Basin 47 and Basin 48 Problem Areas



APPENDIX D –
Figure 5-3A through Figure 5-3W: Ultimate Sewer Model Analysis Results

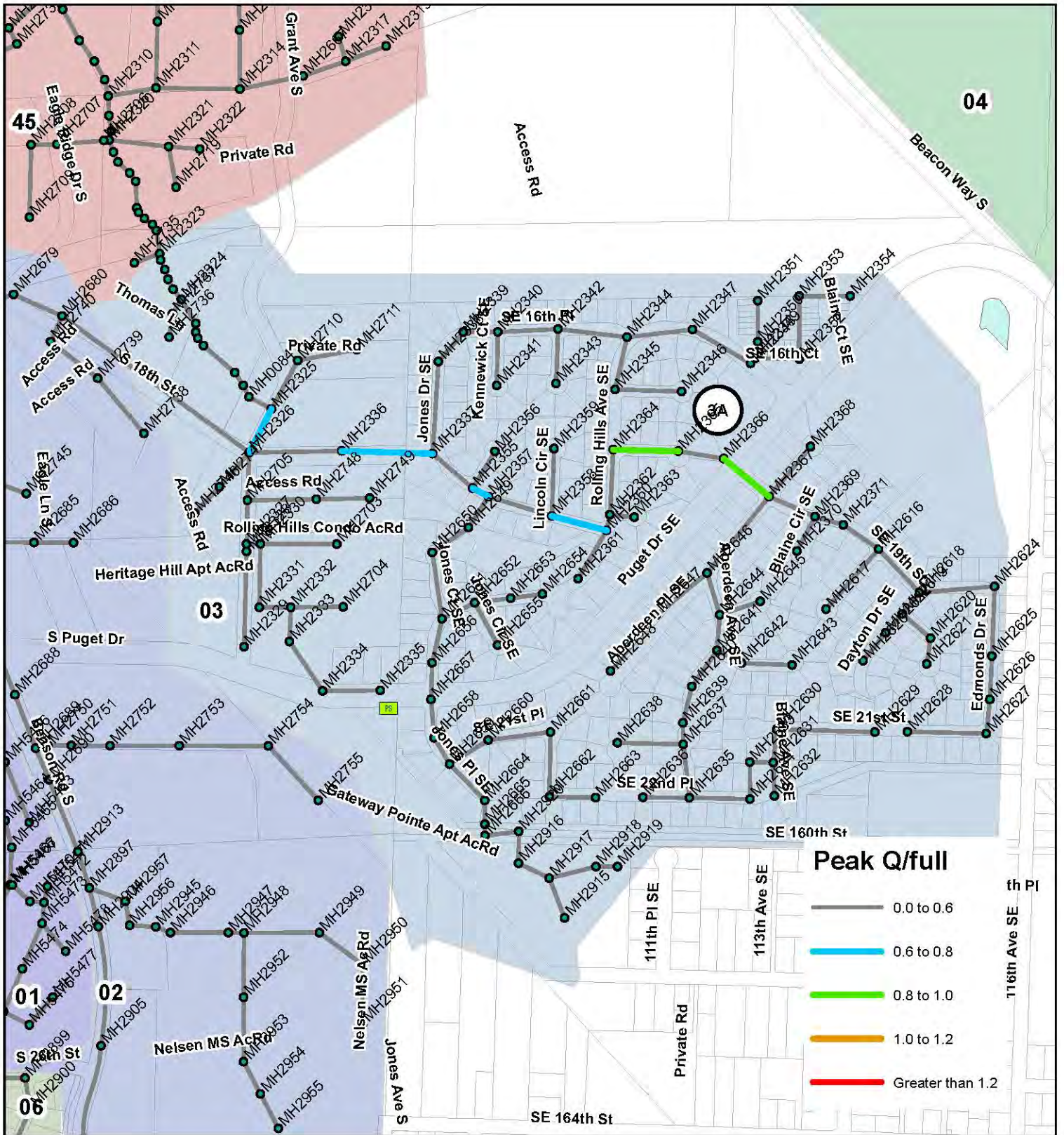
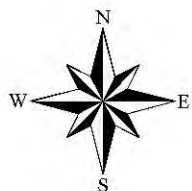

Figure 5-3A

City of Renton
 Ultimate Sewer Model Analysis Results

Basin 3 Problem Areas



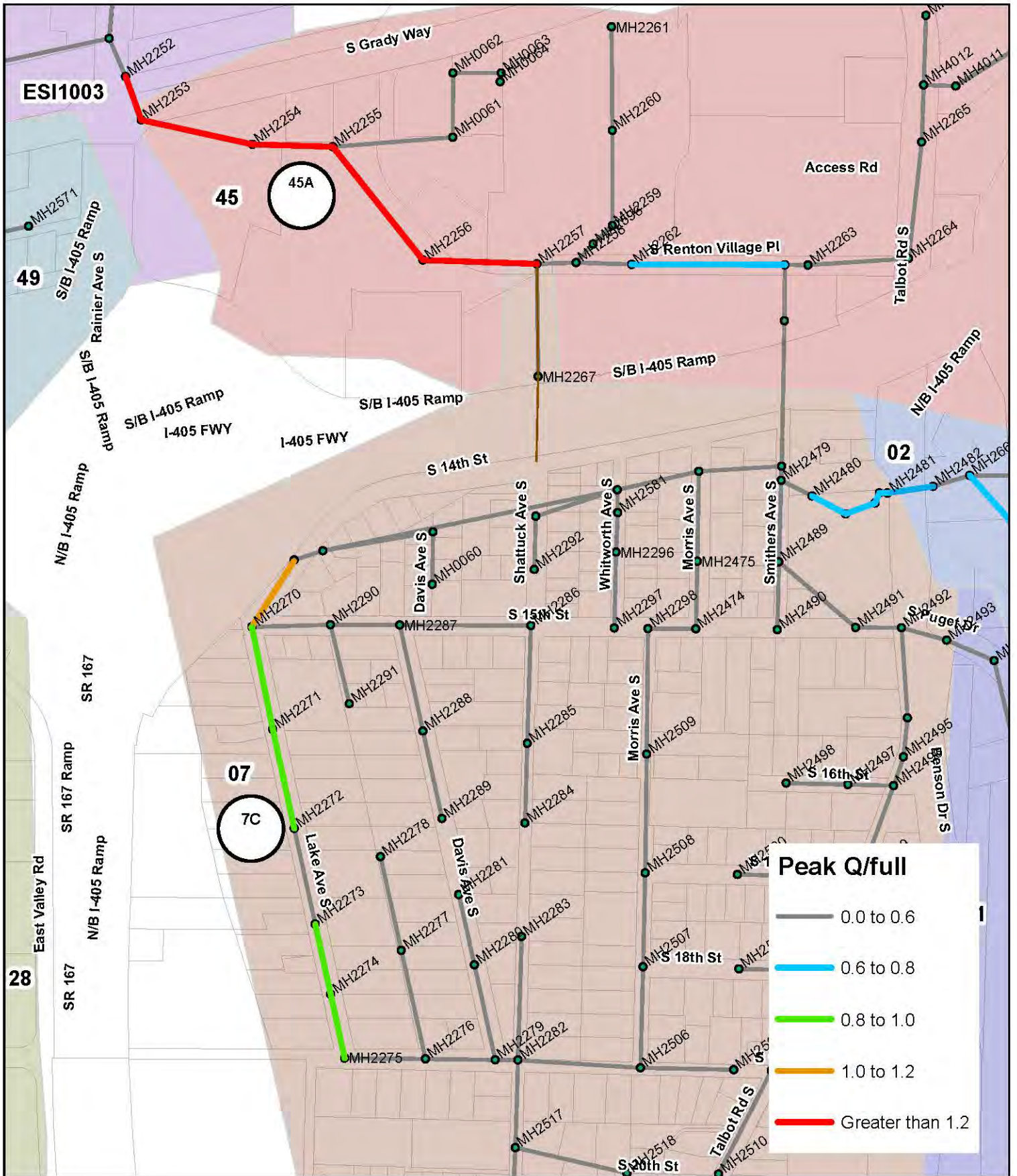
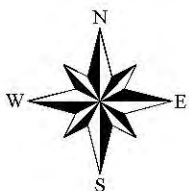

Figure 5-3E

City of Renton
 Ultimate Sewer Model Analysis Results

Basin 7 & Basin 45 Problem Areas



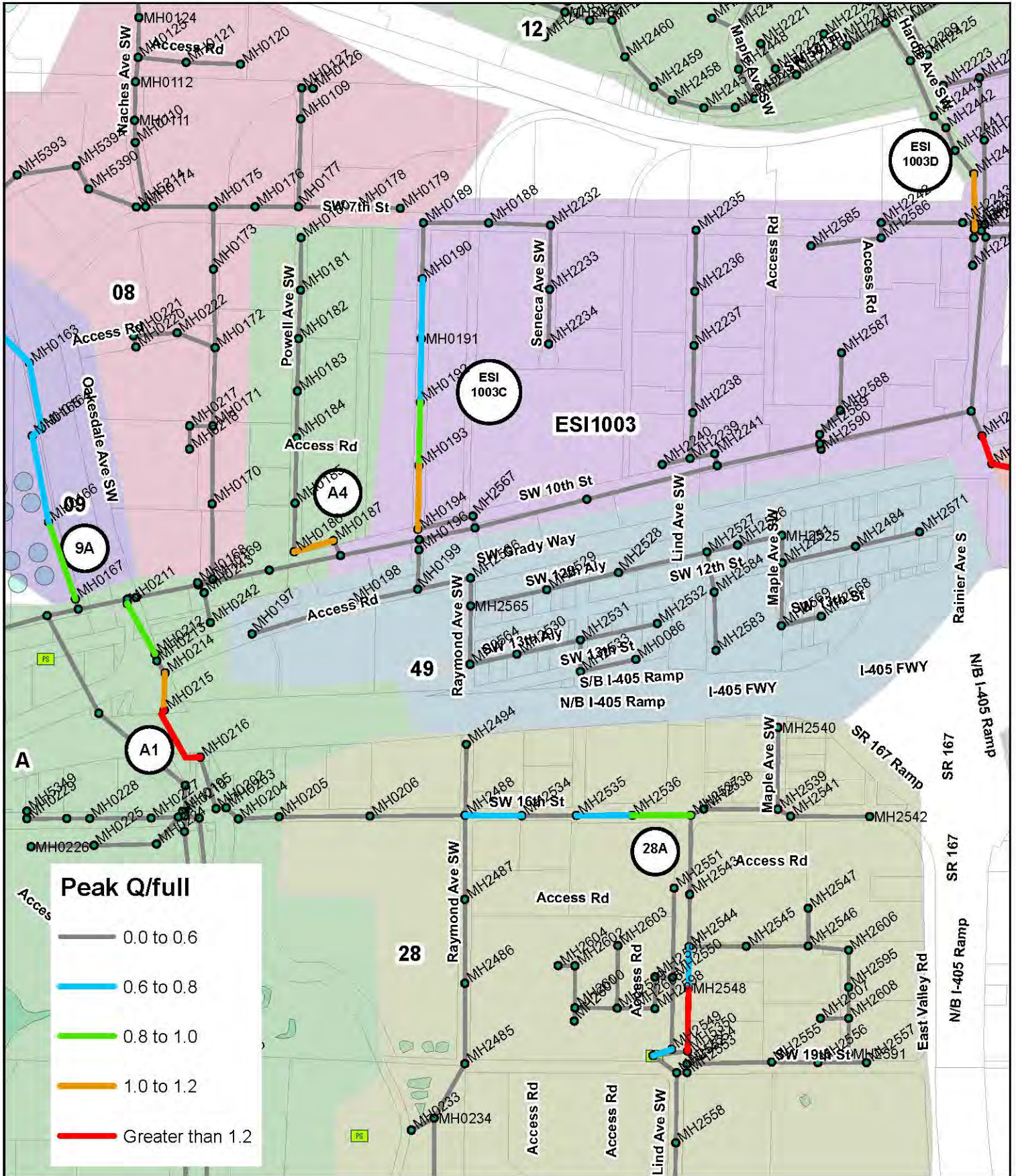
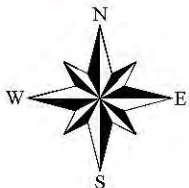

Figure 5-3F

City of Renton
 Ultimate Sewer Model Analysis Results
 Basin 9, Basin A (North), and
 Basin ESI1003 (South) Problem Areas



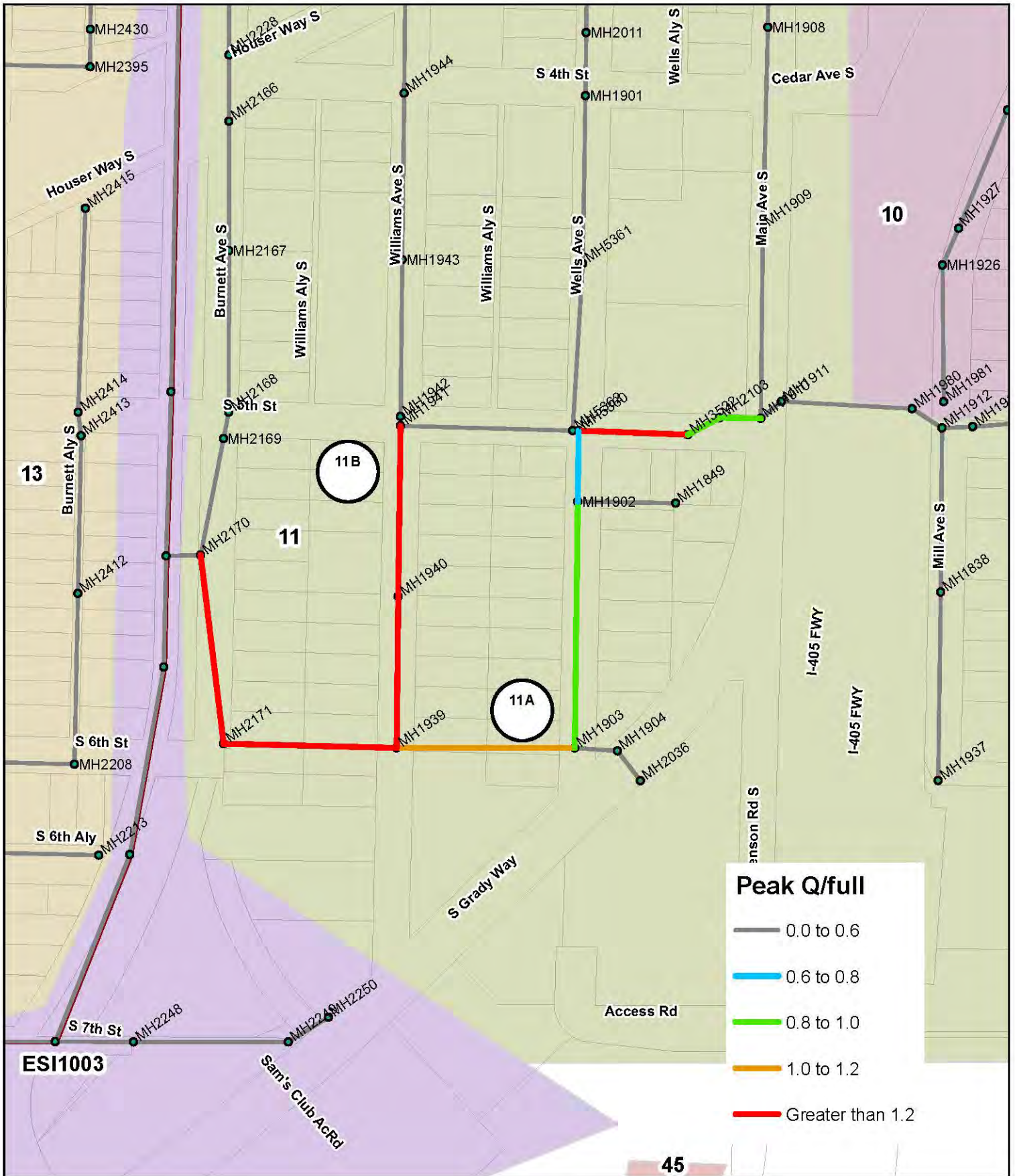
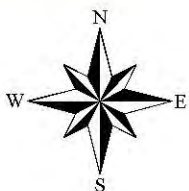

Figure 5-3G

City of Renton
 Ultimate Sewer Model Analysis Results

Basin 11 Problem Areas



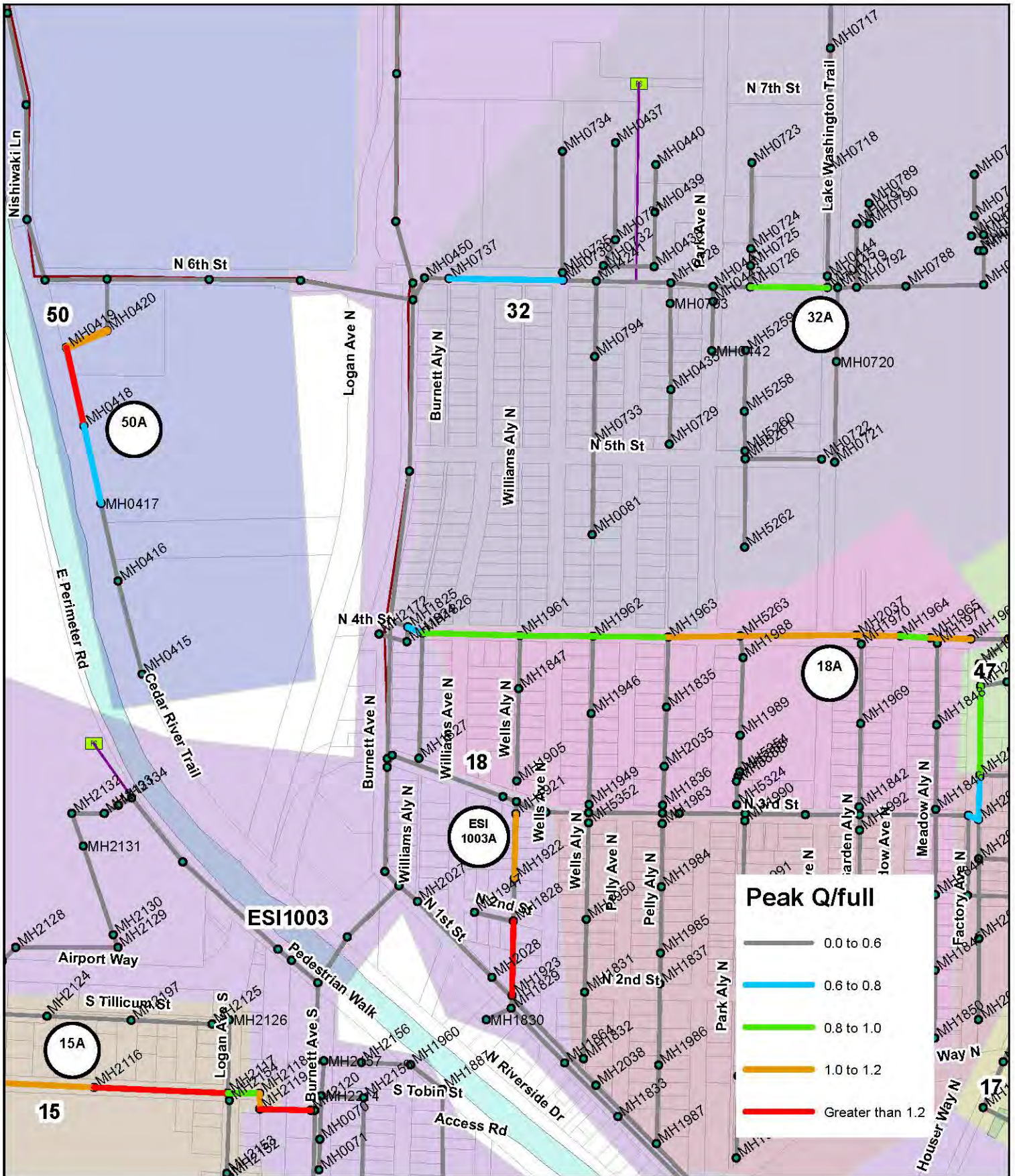
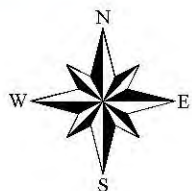

Figure 5-31

City of Renton
 Ultimate Sewer Model Analysis Results
 Basin 18, Basin 32, Basin 50, &
 Basin ESI1003 (Middle) Problem Areas



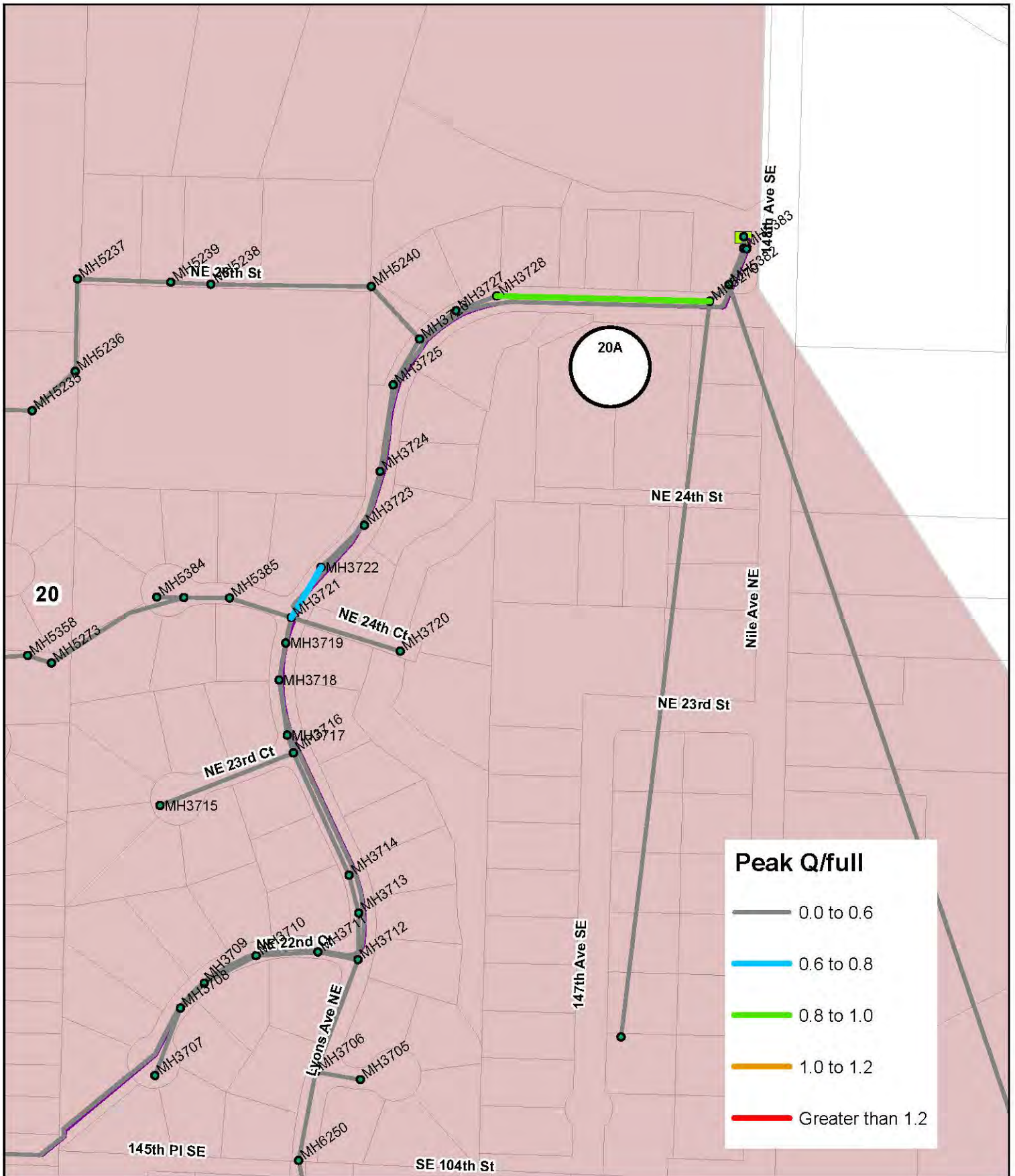
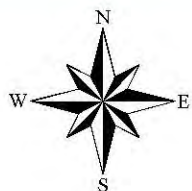

Figure 5-3J

City of Renton
 Ultimate Sewer Model Analysis Results

Basin 20 Problem Areas



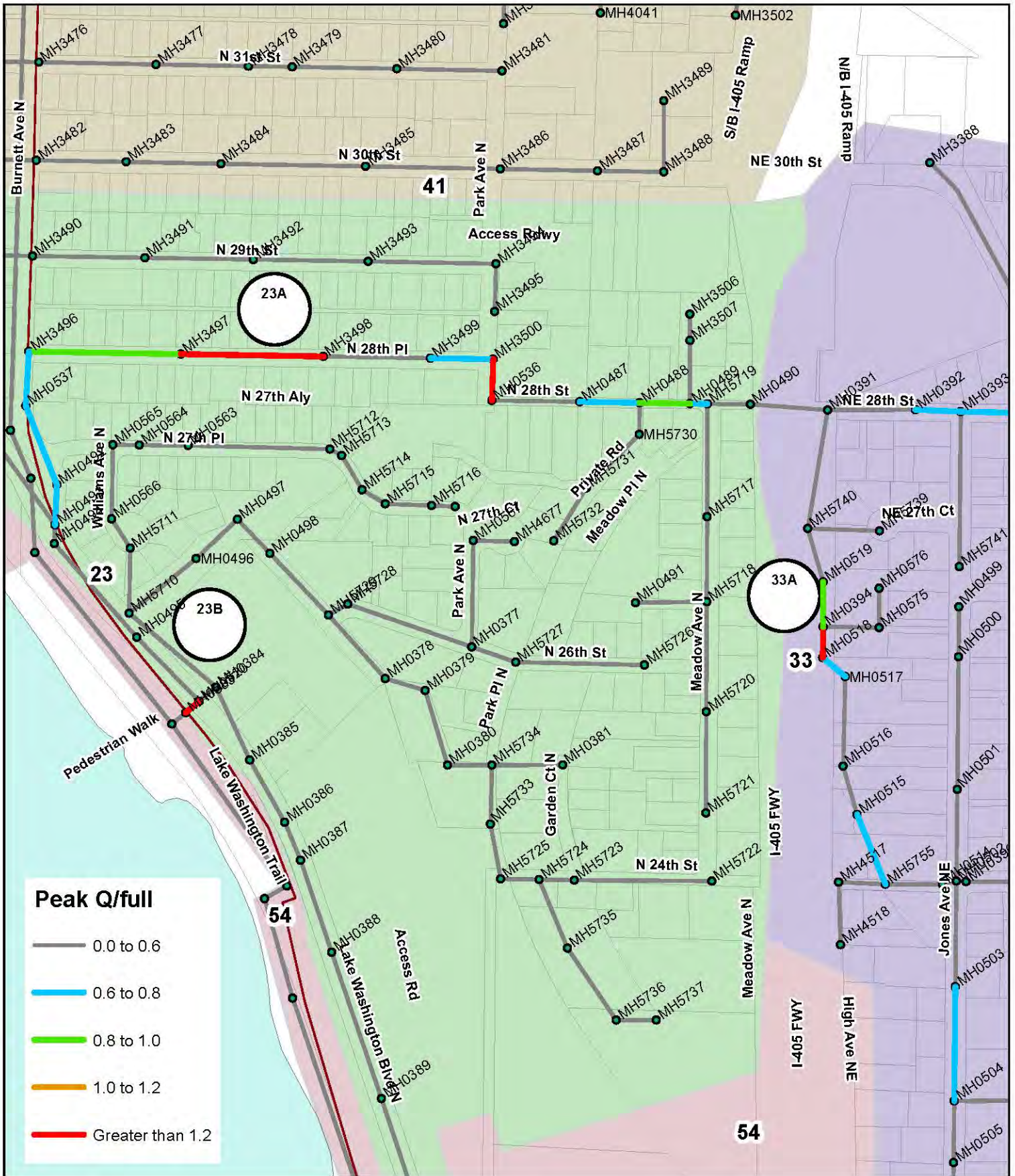
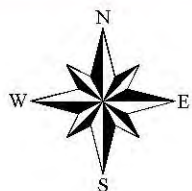

Figure 5-3L

City of Renton
 Ultimate Sewer Model Analysis Results

Basin 23 & Basin 33 Problem Areas



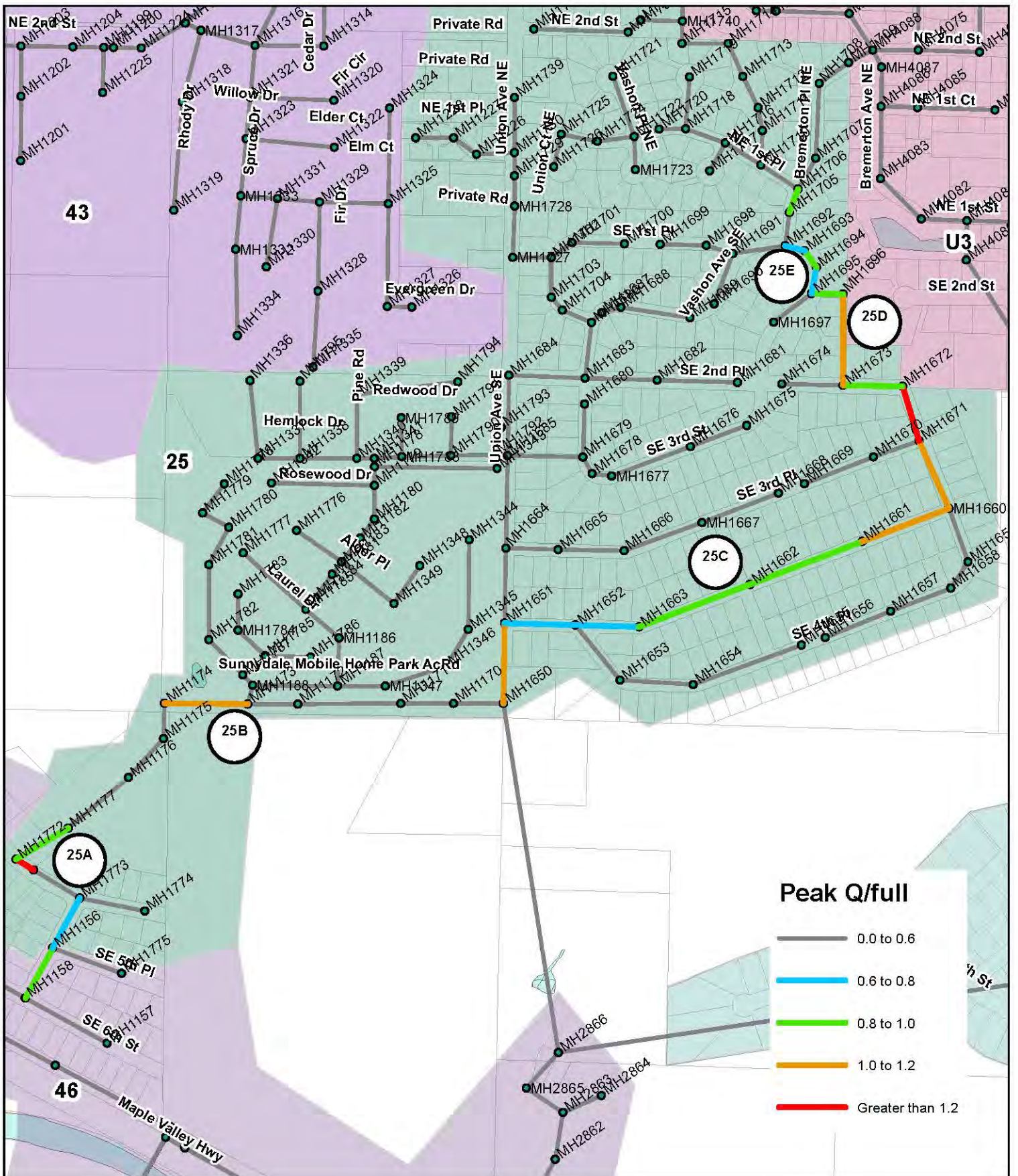
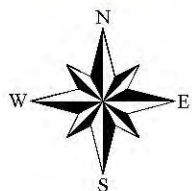

Figure 5-3M

City of Renton
 Ultimate Sewer Model Analysis Results

Basin 25 Problem Areas



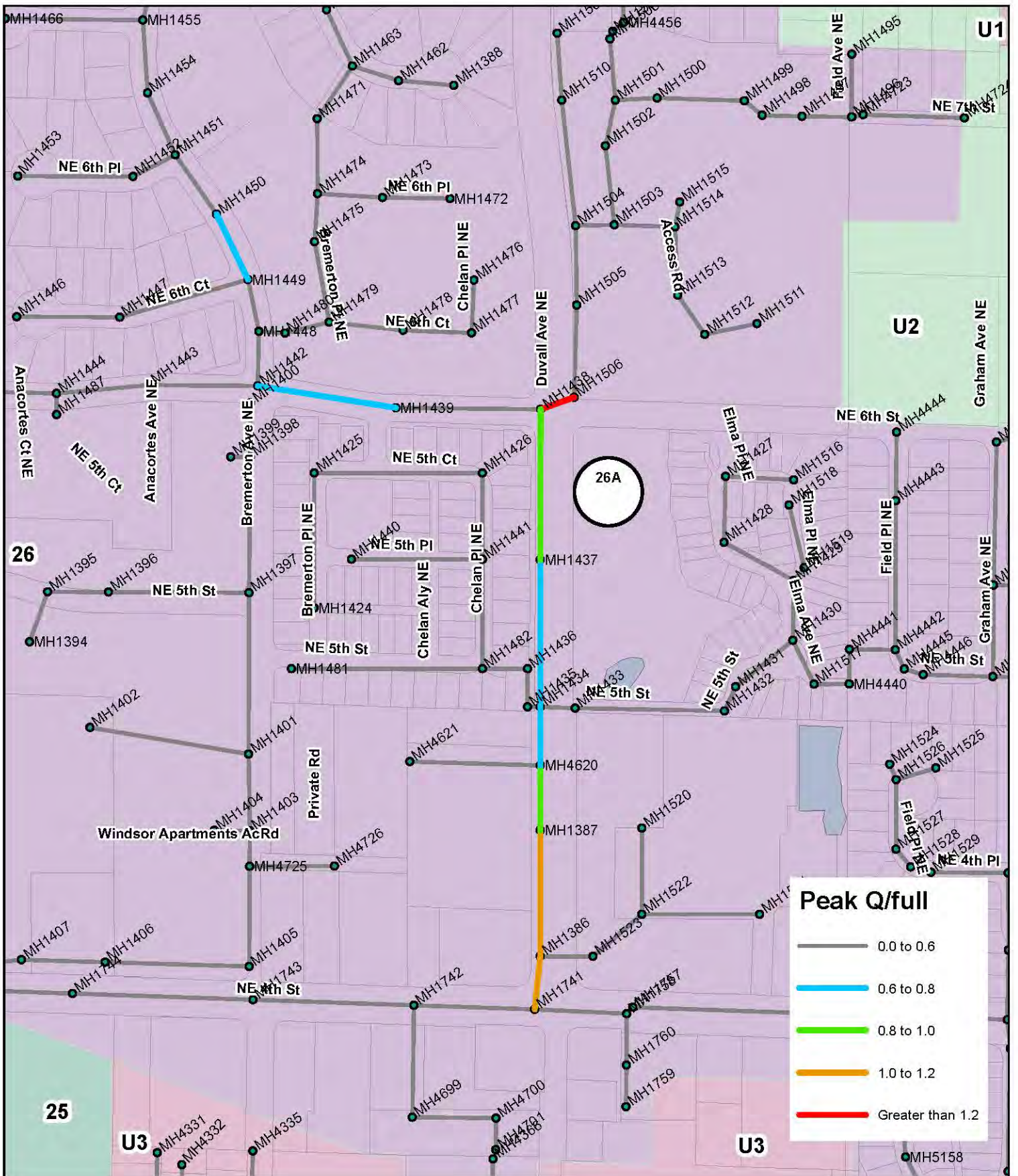
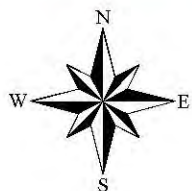

Figure 5-3N

City of Renton
 Ultimate Sewer Model Analysis Results

Basin 26 Problem Areas



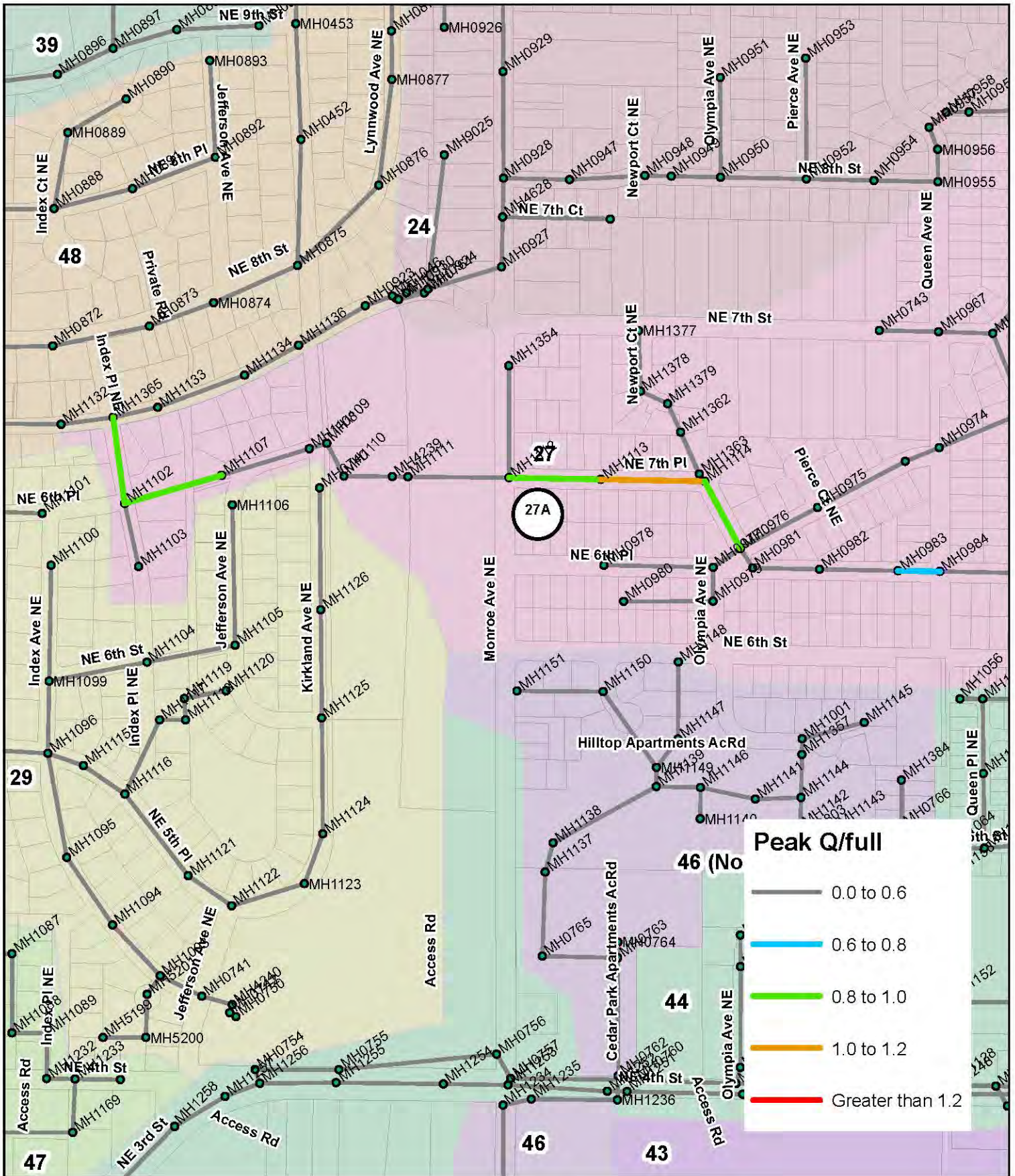
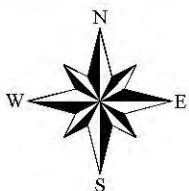

Figure 5-30

City of Renton
 Ultimate Sewer Model Analysis Results

Basin 27 Problem Areas



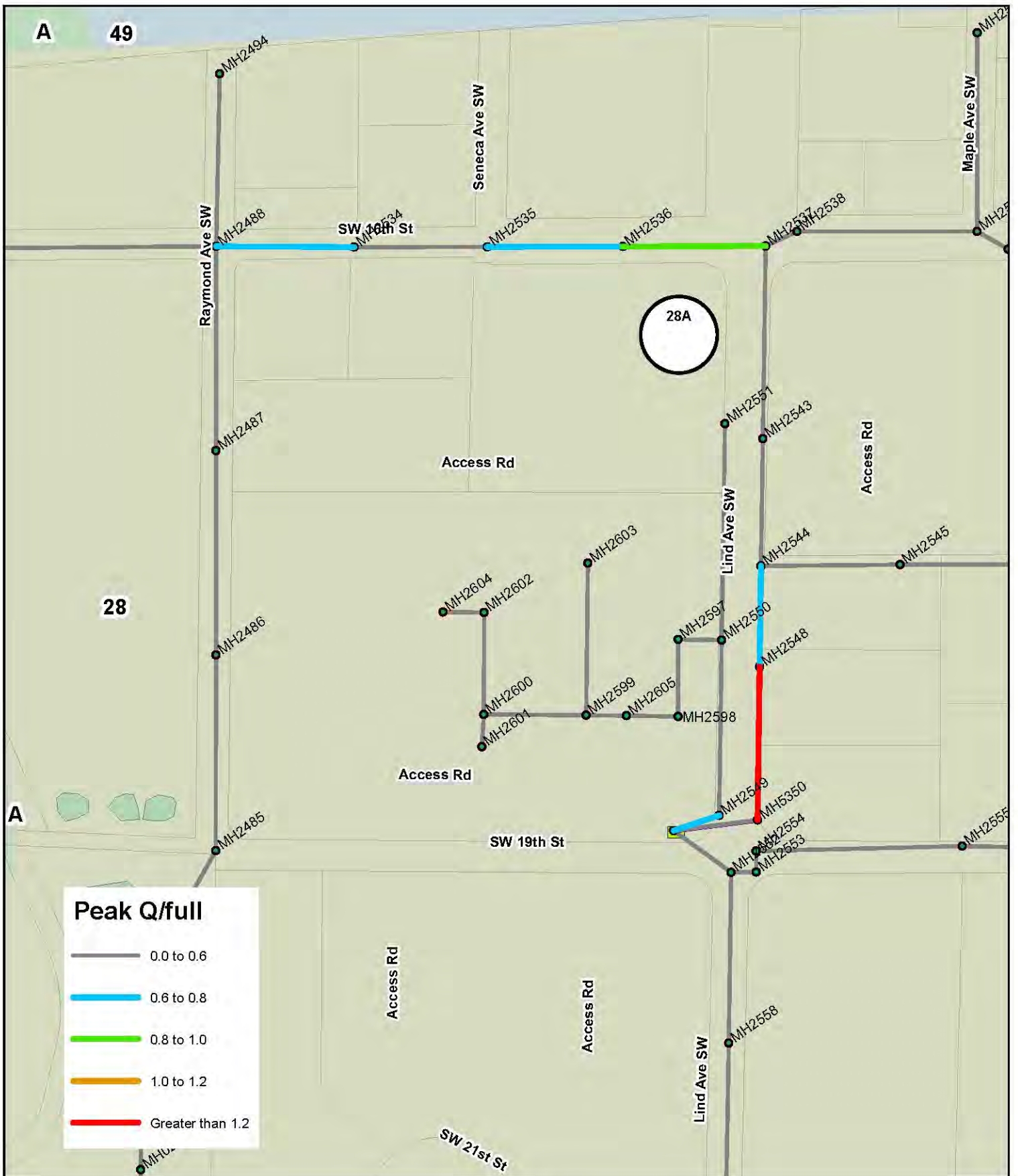

Figure 5-3P

City of Renton
 Ultimate Sewer Model Analysis Results

Basin 28 Problem Areas



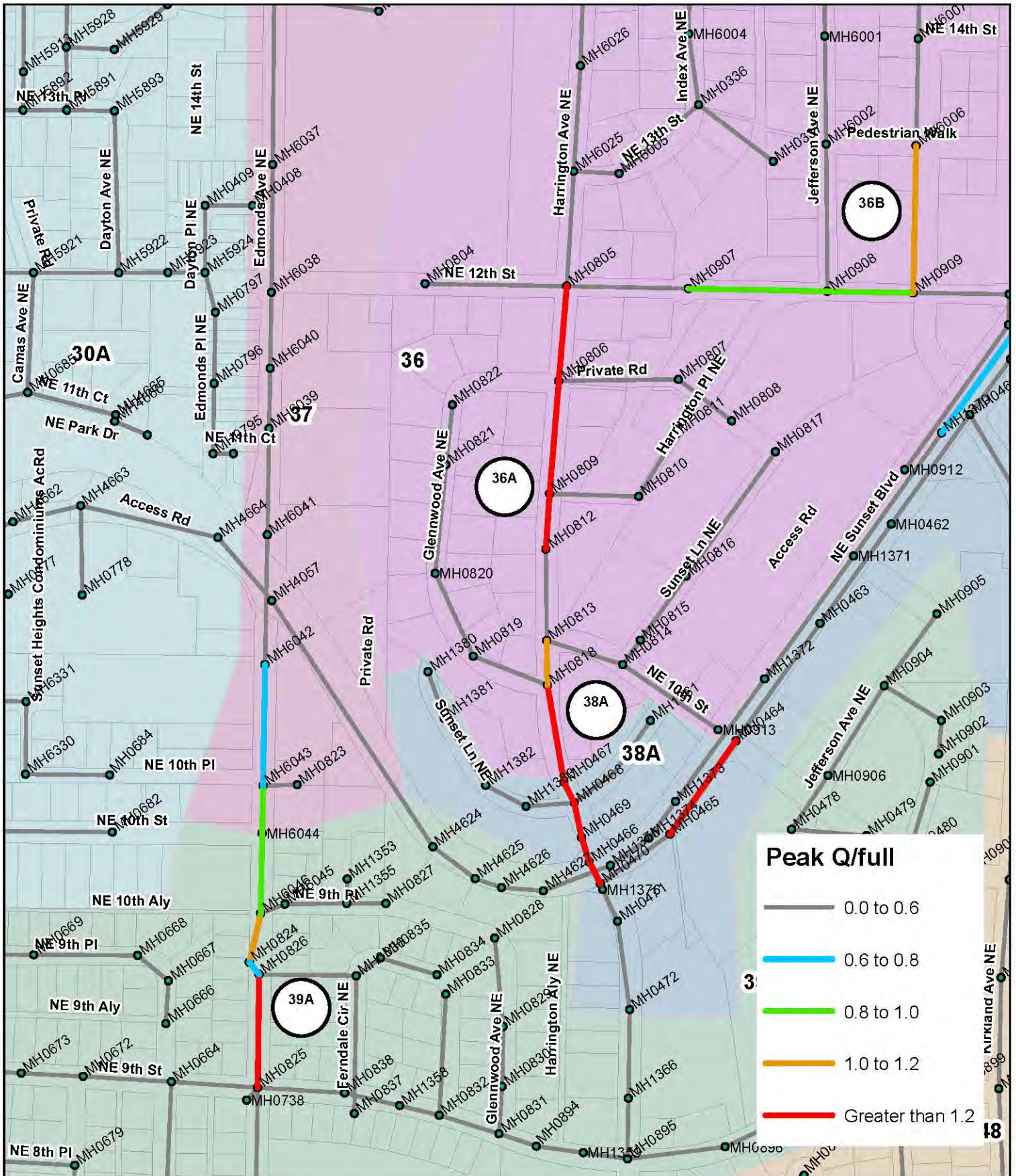

Figure 5-3Q

City of Renton
 Ultimate Sewer Model Analysis Results



Basin 36, Basin 38, & Basin 39 Problem Areas

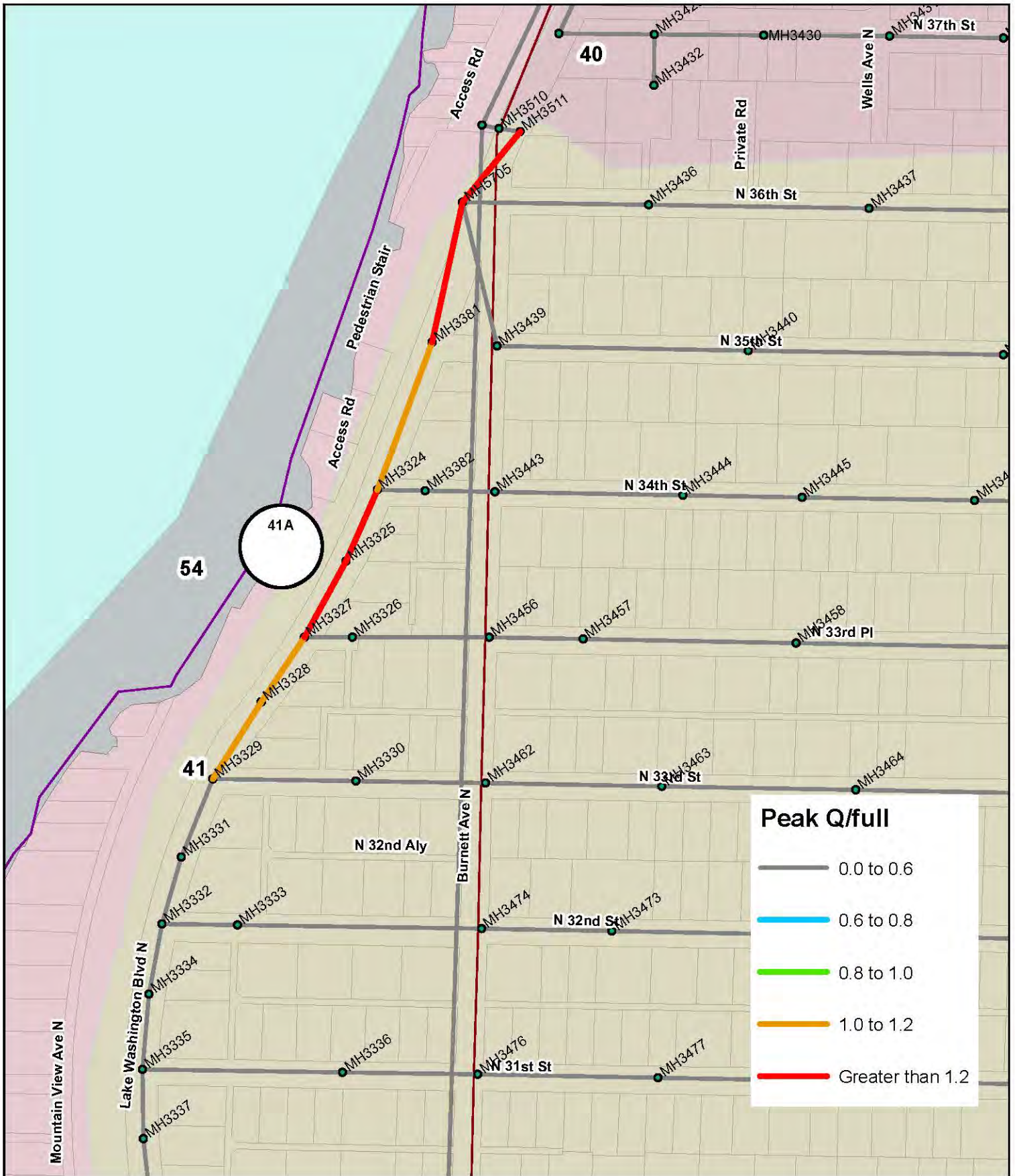
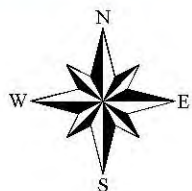

Figure 5-3R

City of Renton
 Ultimate Sewer Model Analysis Results

Basin 41 Problem Areas



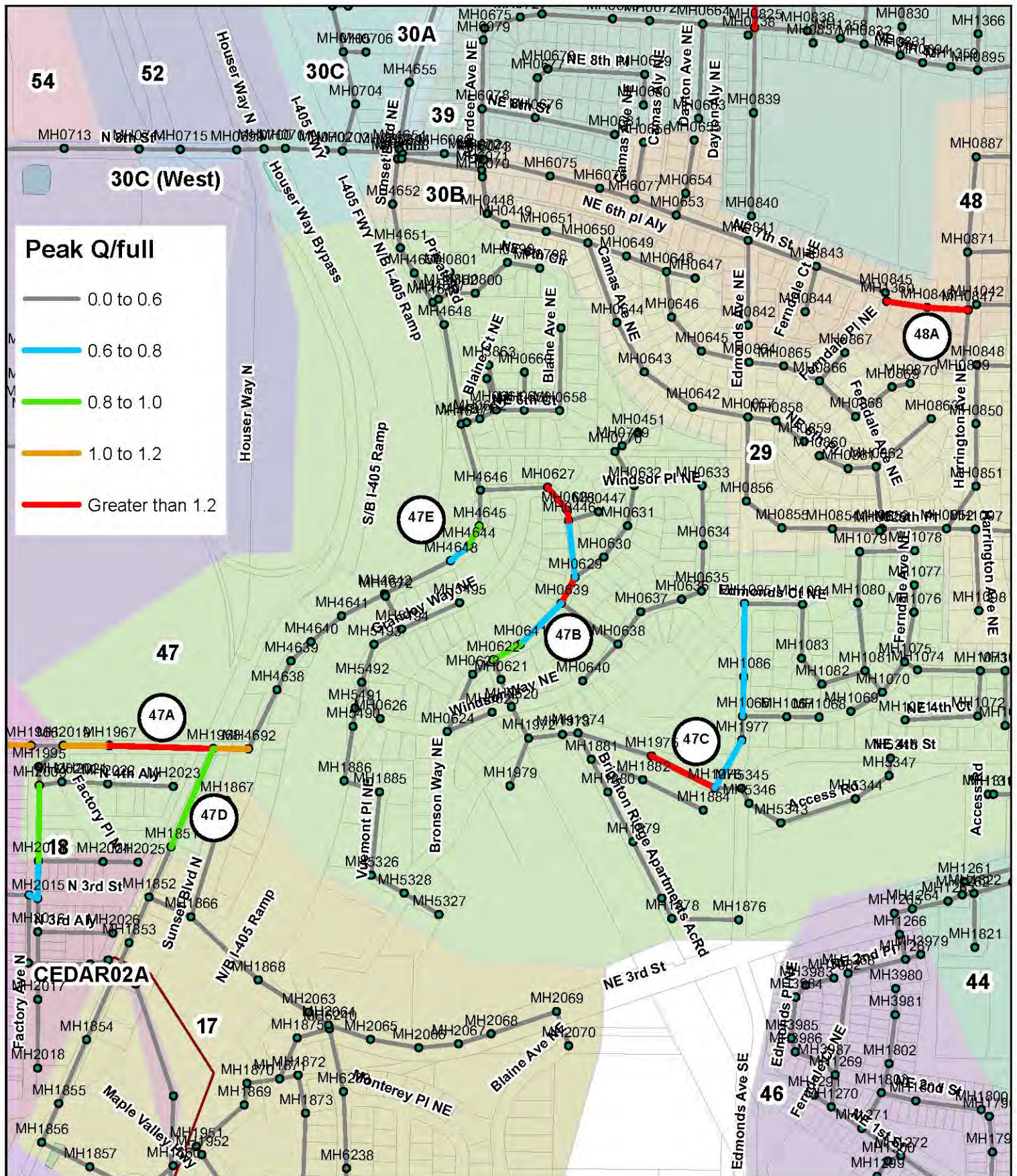

Figure 5-3T

City of Renton
 Ultimate Sewer Model Analysis Results

Basin 47 & Basin 48 Problem Areas



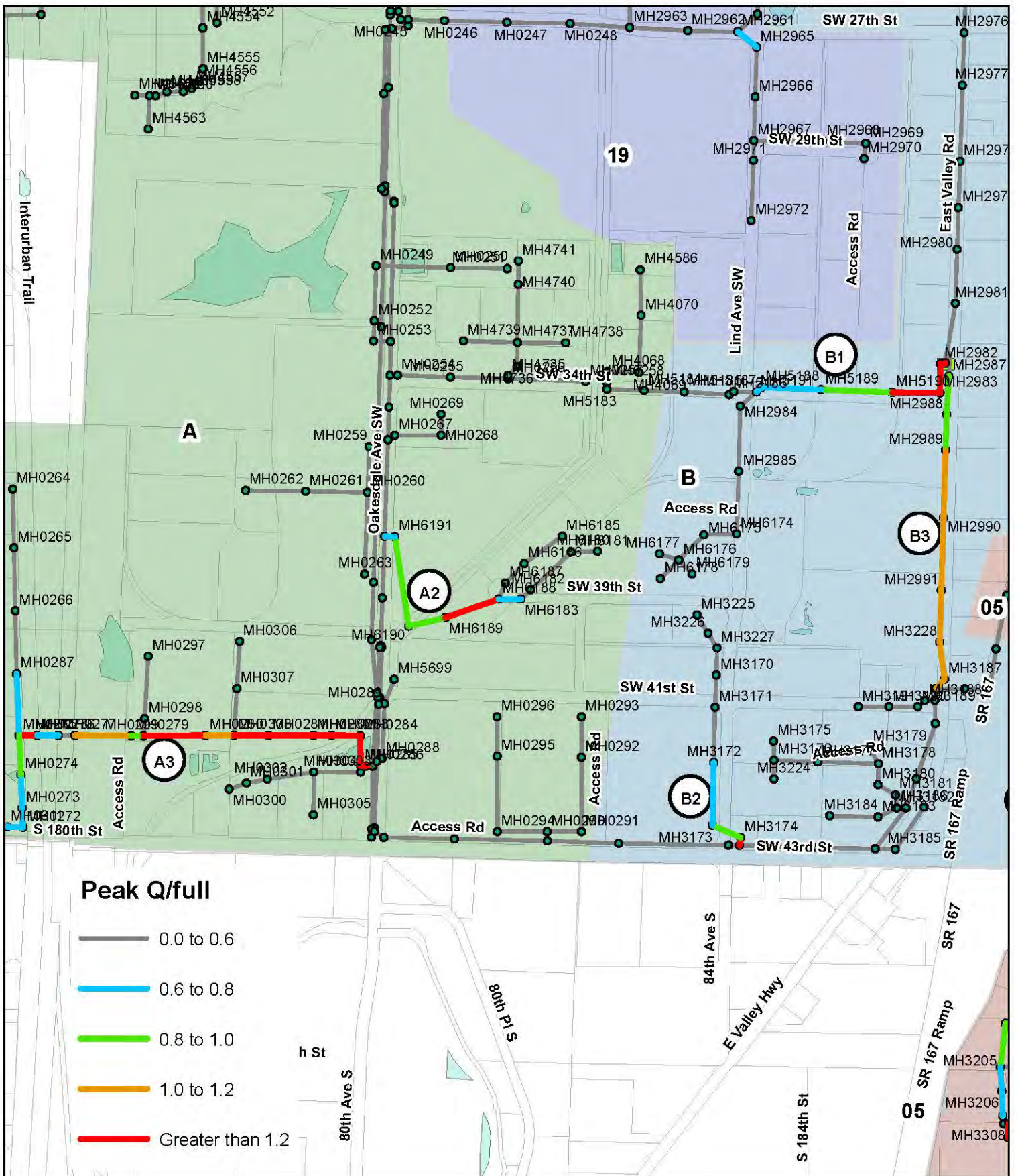
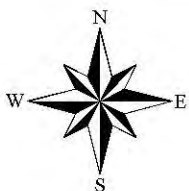

Figure 5-3U

City of Renton
 Ultimate Sewer Model Analysis Results
 Basin A (South) & Basin B Problem Areas



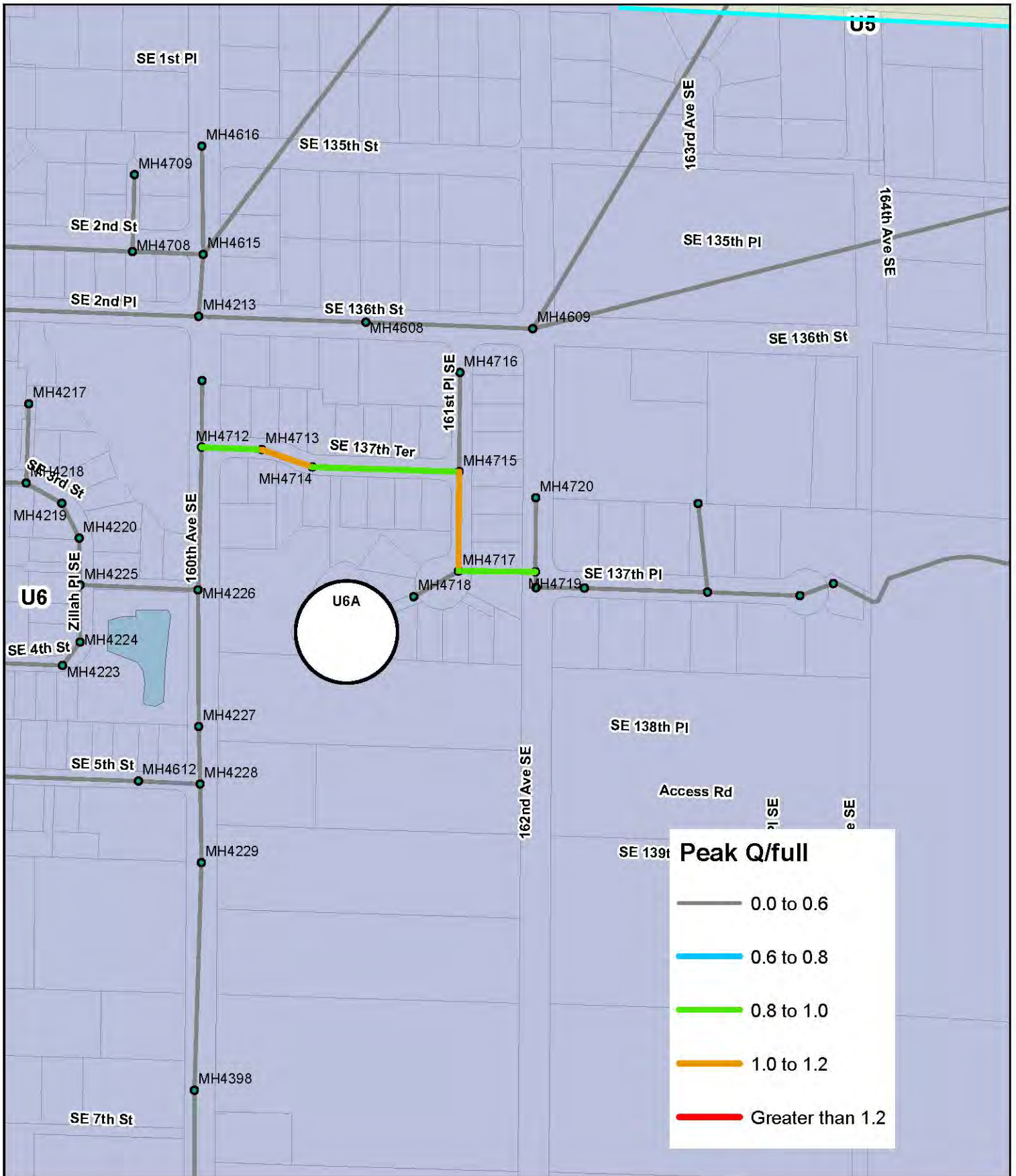
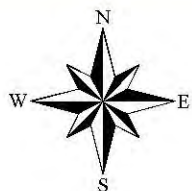

Figure 5-3W

City of Renton
 Ultimate Sewer Model Analysis Results

Basin U6 Problem Areas



Appendix G
TM 1 - RAIN AND FLOW MONITORING AND
PROJECTIONS



City of Renton
LRWWMP

Technical Memorandum 1 RAIN AND FLOW MONITORING & PROJECTIONS

DRAFT | September 2019





City of Renton
LRWWMP

Technical Memorandum 1 RAIN AND FLOW MONITORING & PROJECTIONS

DRAFT | September 2019

This document is released for the purpose of information exchange review and planning only under the authority of Daniel L. Reisinger, September 20, 2019 Washington PE License No. 53657.

Contents

Technical Memorandum 1 Rain and Flow Monitoring & Projections	1-1
1.1 Study Area	1-1
1.2 Sewer Collection System Flows	1-1
1.2.1 Dry Weather Flow Components	1-1
1.2.2 Wet Weather Flow	1-4
1.3 Flow Monitoring Program	1-7
1.3.1 Program Description	1-7
1.3.2 Flow Monitoring Results	1-12
1.3.3 Dry Weather Flow Projections	1-17
1.3.4 Wet Weather Flow Projections	1-19

Attachments

Attachment A	ADS 2018-2019 Flow Monitoring Report
Attachment B	ADWF Development Review Packet

Tables

Table 1.1	Flow Meter General Information	1-7
Table 1.2	Dry Weather Flow Summary	1-13
Table 1.3	Rainfall Event Summary for Calibration (2017-2018)	1-13
Table 1.4	Flow Meter Basins ADWF Development	1-18
Table 1.5	Wet Weather Flow Development	1-20

Figures

Figure 1.1	Study Area Boundary	1-1
Figure 1.2	Typical Wastewater Flow Components	1-3
Figure 1.3	Typical Sources of Inflow and Infiltration	1-5
Figure 1.4	Typical Effects of Inflow and Infiltration	1-6
Figure 1.5	Flow Monitoring Locations	1-9
Figure 1.6	Flow Monitoring Schematic	1-11
Figure 1.7	Typical Weekday vs Weekend Dry Weather Flow Variation (MH0537)	1-14
Figure 1.8	Typical Rainfall Activity over Flow Monitoring Period	1-15

Figure 1.9	Rainfall Accumulation Plot	1-16
Figure 1.10	Example of Wet Weather Flow Response (MH1360)	1-17
Figure 1.11	LRWWMP Design Storms	1-19

Abbreviations

ADWF	Average Dry Weather Flow
BI	base infiltration
BWF	base wastewater flow
Carollo	Carollo Engineers, Inc.
City	City of Renton
d/D	depth vs diameter
DEQ	Department of Environmental Quality
DWF	dry weather flow
gpd/ac	gallons per day per acre
GWI	Groundwater Infiltration
I/I	Inflow and Infiltration
LRWWMP	Long Range Wastewater Management Plan
mgd	million gallons per day
PE	Person Equivalent
PWWF	Peak Wet Weather Flow
SSOs	sanitary sewer overflows
TM	Technical Memorandum
WWF	wet weather flow

Technical Memorandum 1

RAIN AND FLOW MONITORING & PROJECTIONS

This Technical Memorandum (TM) reviews the existing wastewater flows and presents the projected wastewater flows for future conditions within the City of Renton's (City) wastewater collection system. Existing flows are based on data collected by ADS's flow monitoring program (further detail in Attachment A) and the Person Equivalent (PE) developed by Stantec (further detail in Appendix F).

1.1 Study Area

The collection system area is served, owned and operated by the City. The City's existing wastewater service area is illustrated in Figure 1.1, and mostly follows City limits. The flow projections for this study only include the portion of the system within the service area identified in Figure 1.1. The extent of the future wastewater service area matches the exiting wastewater service area. No additional area will be included to the City's existing wastewater service area in the 20-year planning horizon. The Service Area boundary on Figure 1.1 will be called Study Area for the remainder of this project.

1.2 Sewer Collection System Flows

Sewer collections systems are intended to convey sanitary flows from customers (dry weather flow [DWF]), but frequently have additional flows from other sources (wet weather flow [WWF]). The different flow components are described in the section below and illustrated in Figure 1.2.

1.2.1 Dry Weather Flow Components

There are two primary components of DWF.

1.2.1.1 Base Wastewater Flow

The base wastewater flow (BWF) is the sanitary flow generated by routine water usage of the City's residential, commercial, and industrial customers. Conveying this flow is the primary function of the collection system. The flow has a diurnal pattern that varies by customer. Typically, a residential diurnal pattern has two peaks with the more pronounced peak following the wake-up hours of the day, and a less pronounced peak occurring in the evening. Commercial and industrial patterns, though they vary depending on the type of use, typically have more consistent higher flow patterns during business hours, and lower flows at night. Furthermore, the diurnal flow pattern of a weekend may vary from the diurnal flow experienced during a weekday.

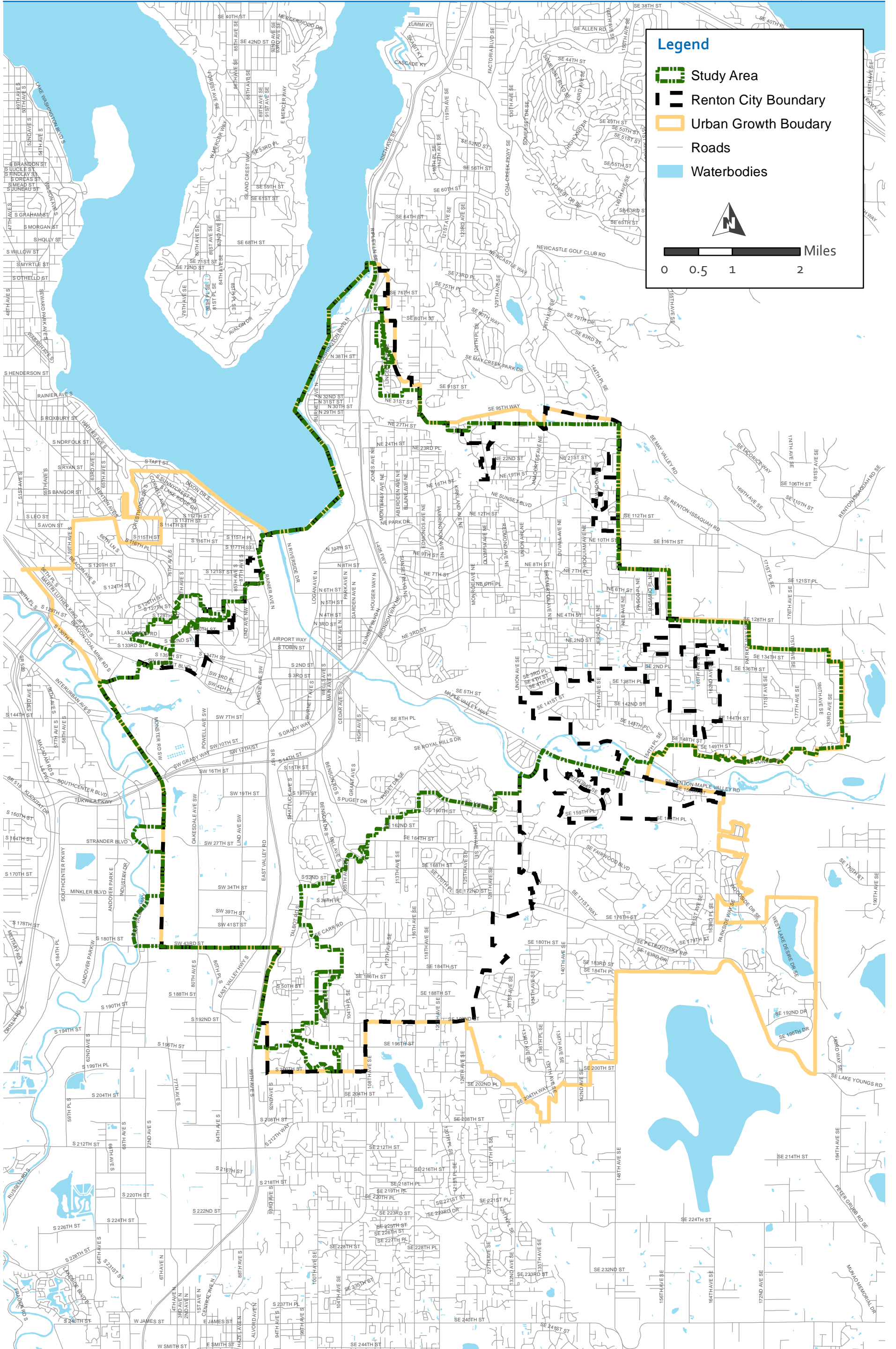

Legend

- - - Study Area
- - - Renton City Boundary
- Urban Growth Boundary
- Roads
- Waterbodies

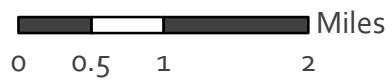

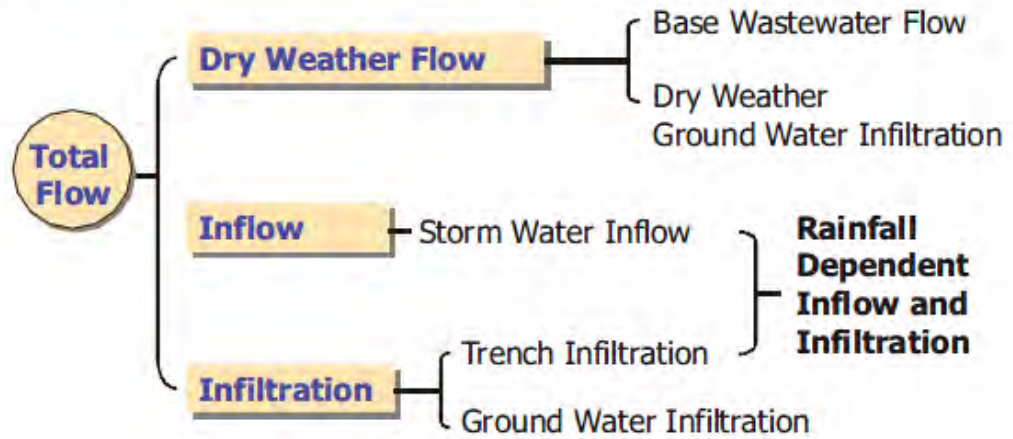
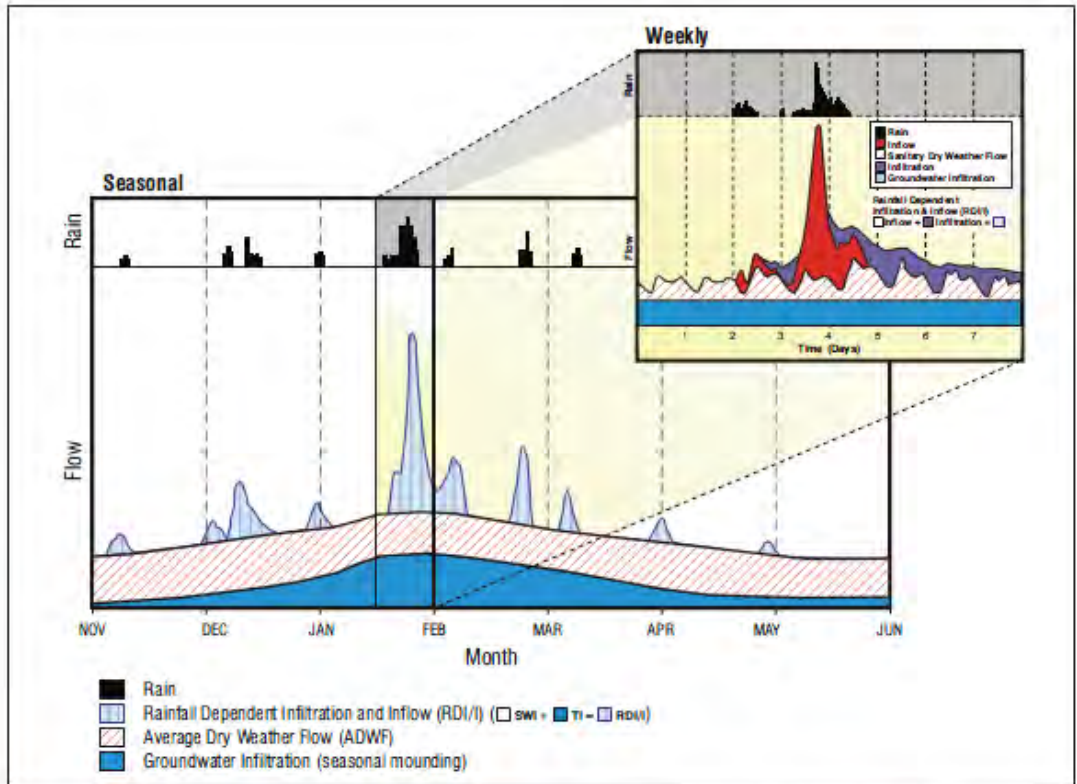

Note: This figure is not based on flow data specific to the City or this Master Plan

Figure 1.2 Typical Wastewater Flow Components

1.2.1.2 Dry Weather Groundwater Infiltration

Dry weather Groundwater Infiltration (GWI) will enter the sewer system when the relative depth of the groundwater table is higher than the depth of the pipeline and the sanitary sewer pipe allows infiltration through defects such as cracks, misaligned joints, and broken pipelines. Dry weather GWI (or base infiltration) cannot easily be separated from BWF by flow measurement techniques. Therefore dry weather GWI is typically grouped with BWF.

1.2.1.3 Average Dry Weather Flow

Average Dry Weather Flow (ADWF) is the average flow that occurs on a daily basis during the dry weather season, and is estimated from the DWFs during the monitoring period. Based on the flow monitoring, the ADWF is approximately 8.97 million gallons per day (mgd). The ADWF serves as the baseline flow in the hydraulic model. Diurnal (24-hour) patterns are applied to ADWFs, and cumulatively make up the flows experienced at the outfalls of the collection system. The diurnal patterns utilized for the City's collection system basins are developed in Section 1.3 and described in detail in the ADS Flow Monitoring Report, Attachment A.

1.2.2 Wet Weather Flow

WWF includes two components:

1. Inflow and Infiltration (I/I): The stormwater I/I response in the sewer system to rainfall is seen immediately (inflow) or within hours after the storm (infiltration).
2. GWI: Wet weather GWI is not specific to a single rainfall event, but rather to the effects on the sewer system over the entire wet weather season. The depth of the groundwater table rising above the pipe invert elevation causes GWI. Sewer pipes within close proximity to a body of water can be greatly influenced by groundwater effects.

1.2.2.1 Inflow and Infiltration

Inflow is stormwater that enters the sewer system via a direct connection to the system, such as roof drain and downspout connections, leaky manhole covers, and inappropriate storm drain connections. Infiltration is stormwater that enters the sewer system by percolating through the soil and then through defects in pipelines, manholes, and joints. Some of the most common sources of I/I are shown in Figure 1.3. The adverse effects of I/I entering the sewer system is that it increases both the flow volume and peak flows such that the sewer system could be operating at or above its capacity, as illustrated in Figure 1.4. If too much I/I enter the sewer system, sanitary sewer overflows (SSOs) could occur.

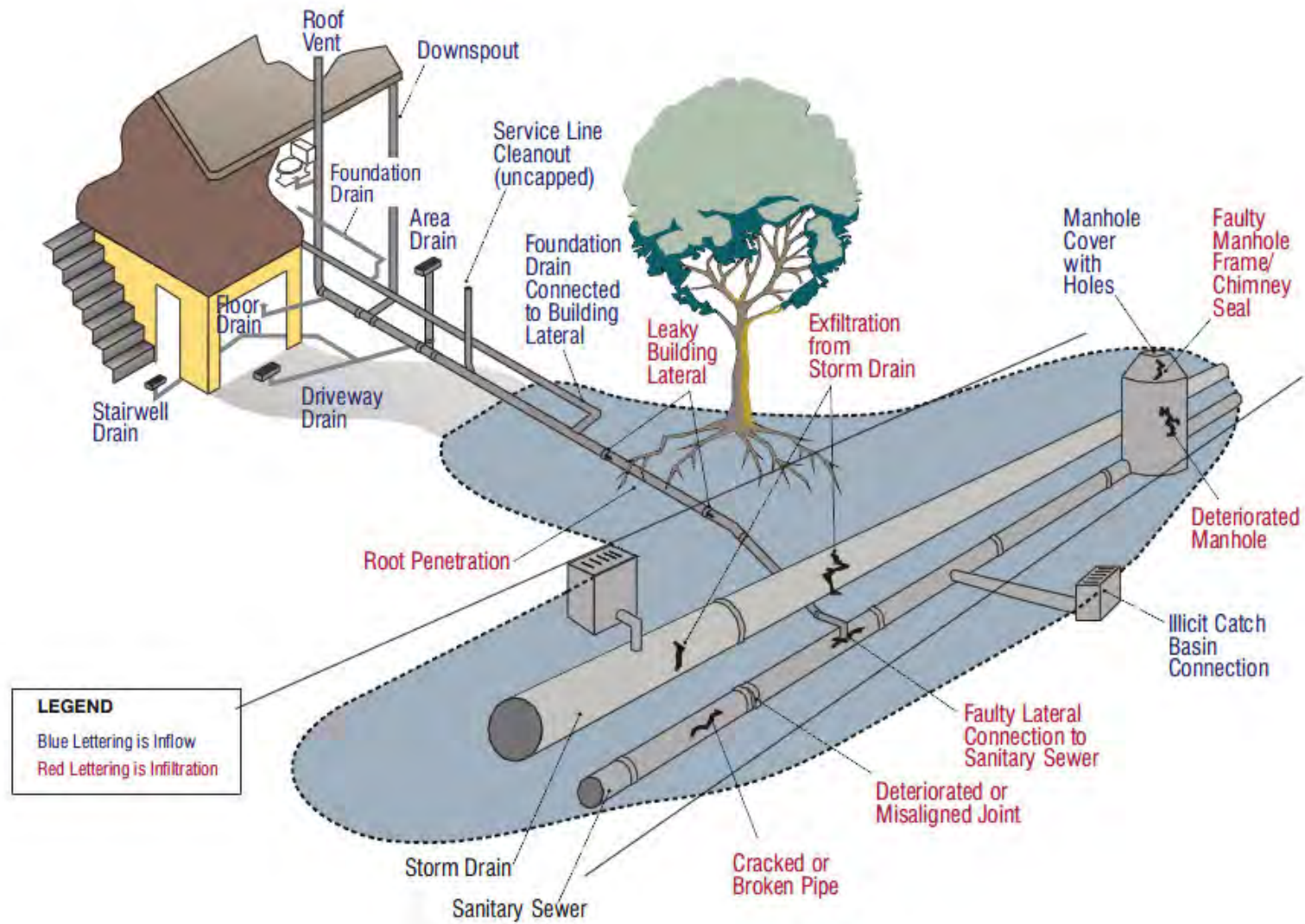

Figure 1.3 Typical Sources of Inflow and Infiltration

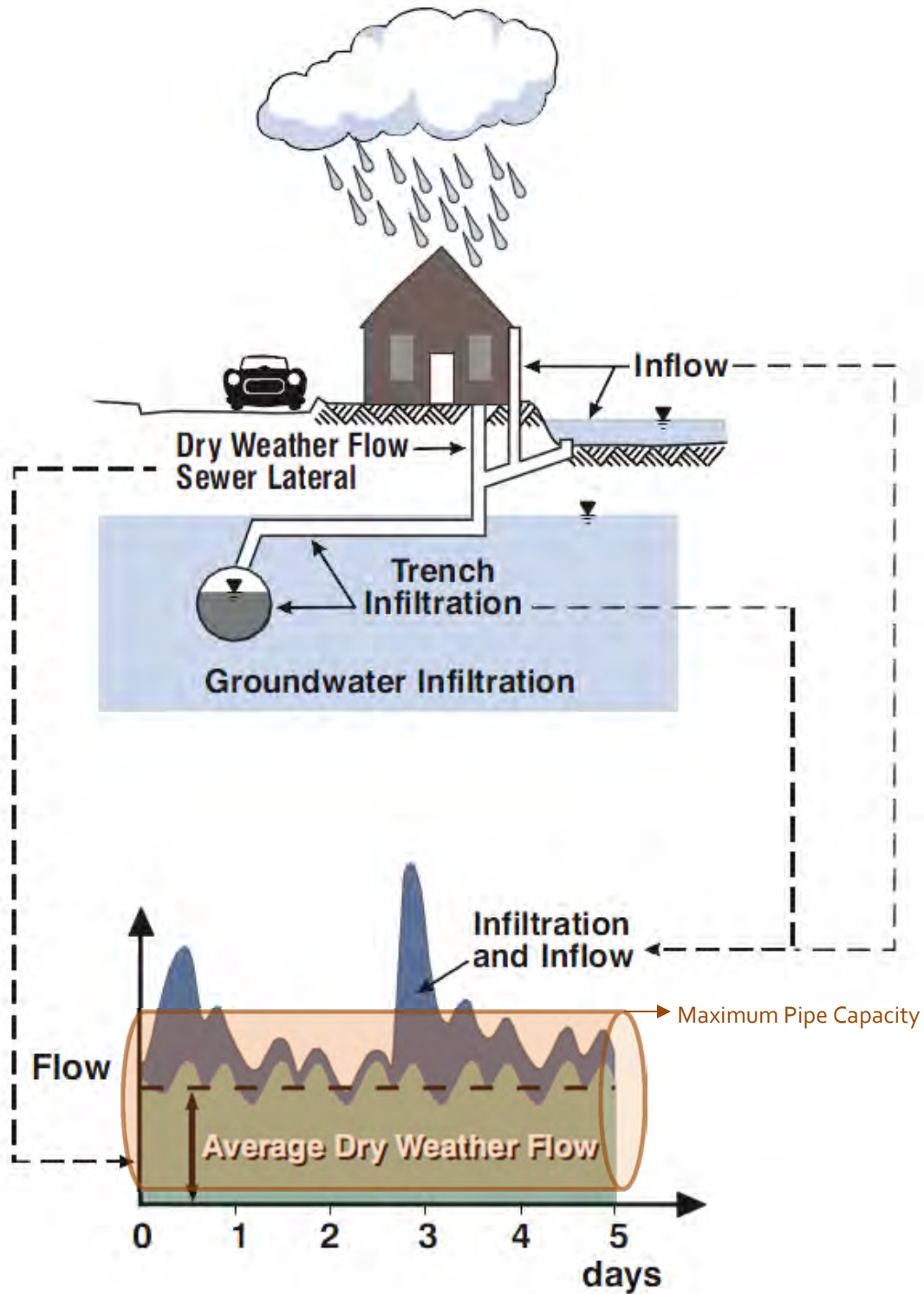

Figure 1.4 Typical Effects of Inflow and Infiltration

1.2.2.2 Groundwater Infiltration

GWI, one of the components of I/I, is associated with extraneous water entering the sewer system through defects in pipes and manholes while the ground is saturated during the wet weather season. GWI is related to the condition of the sewer pipes, manholes, and groundwater levels. GWI may occur throughout the year, although rates are typically higher in the late winter and early spring in the Pacific Northwest.

1.3 Flow Monitoring Program

As part of the Scope of Services for this LRWWMP, Carollo Engineers, Inc. (Carollo) contracted with ADS to conduct a temporary flow monitoring program within the City's sanitary sewer collection system. The purposes of the flow monitoring program were to correlate actual collection system flows to the hydraulic model predicted flows, evaluate the system's capacity, and estimate basin I/I. The temporary flow monitoring data was collected for a period of approximately 4 months from December 22, 2017 to April 22, 2018. The "ADS Flow Monitoring Report" prepared by ADS summarizes the flow monitoring program and was submitted to the City as a stand-alone report. A copy of the report is included in Attachment A.

1.3.1 Program Description

1.3.1.1 Flow Monitoring Sites and Tributary Areas

Eighteen (18) sewer basins were monitored during the flow monitoring period. The meter sites were selected to best isolate and model the critical areas and subareas within the sewer system. The 18 flow monitoring locations, as well as the area tributary to each site, are shown on Figure 1.5. Table 1.1 lists the flow monitoring locations and the diameters for the sewers where the meters were installed. Figure 1.6 provides a schematic illustrating the flow monitoring locations to help understand how the basins connect. In the figure the color of the flow meter represents the accuracy level of the data, blue meters have high quality data while green meters moderate quality data that was considered acceptable for model calibration. The model inflows from outside of the City's collection system are indicated by the orange boxes.

Table 1.1 Flow Meter General Information

Meter ID/Manhole ID	Pipe ID	Pipe Diameter (in.)	Pipe Slope (%)
MH0166	GM00774	12	0.25
MH0286	GM00644	10	0.59
MH0537	GM03983	8	9.91
MH1360	GM01504	10.75	0.19
MH1763	GM02229	15	0.16
MH2116	GM02857	14.5	0.27
MH2171	GM02832	11.25	0.14
MH2252	GM03454	18	0.28
MH2999	GM04100	8	3.32
MH3216	GM03789	7.38	0.55
MH3625	GM00942	12	0.32

Table 1.1 Flow Meter General Information (continued)

Meter ID/Manhole ID	Pipe ID	Pipe Diameter (in.)	Pipe Slope (%)
MH4628	GM01776	10.38	2.95
MH4646	GM04384	8	12.02
MH5302	GM05311	14	0.7
MH5505	GM05711	10	3.9
MH5519	GM05744	10.25	4.52
MH6041	GM05842	8	6.1
MH6704	GM07524	12	0.08

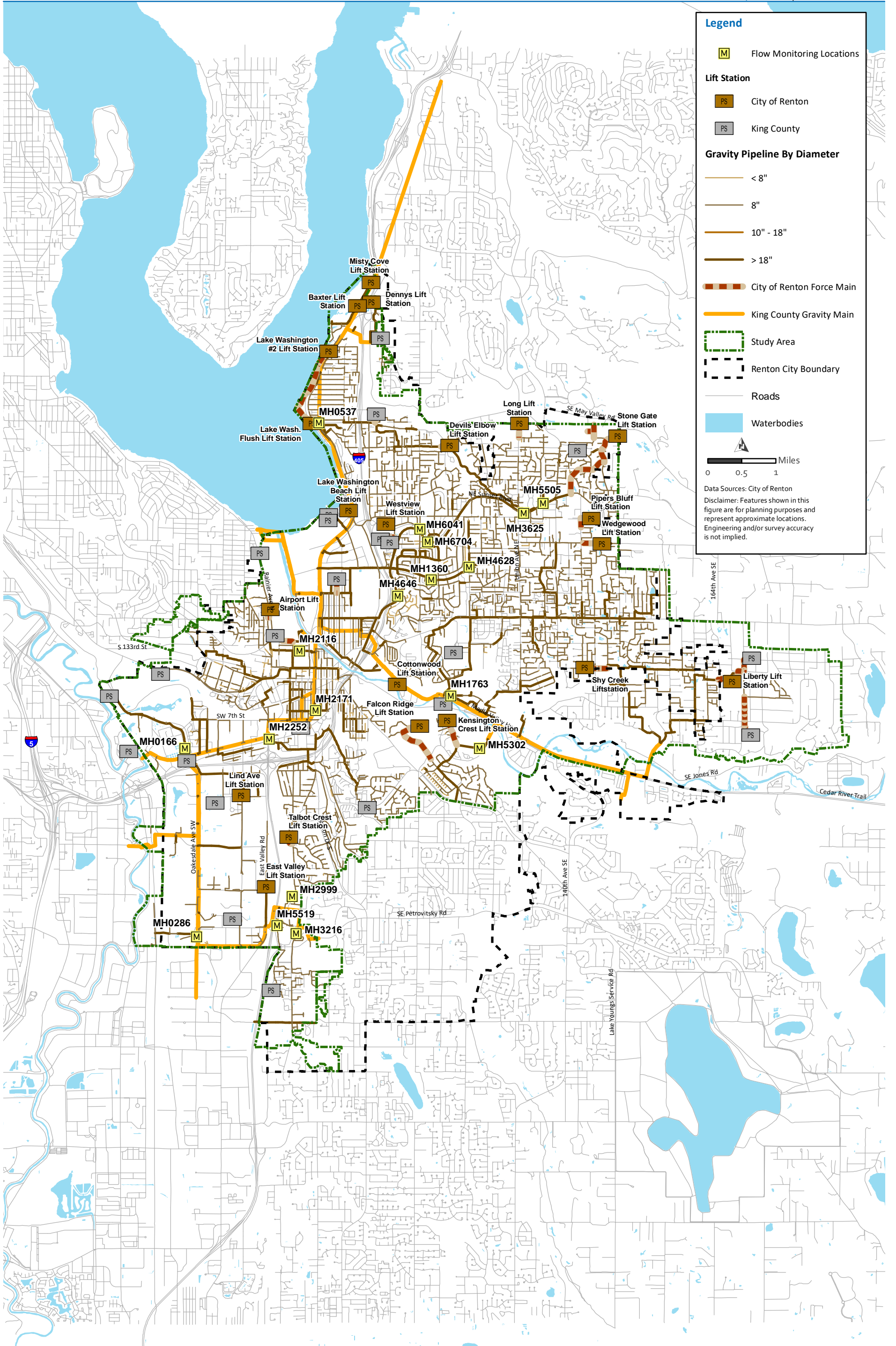

Legend

- M Flow Monitoring Locations
- Lift Station**

 - PS City of Renton
 - PS King County

- Gravity Pipeline By Diameter**

 - < 8"
 - 8"
 - 10" - 18"
 - > 18"

- City of Renton Force Main
- King County Gravity Main
- Study Area
- Renton City Boundary
- Roads
- Waterbodies

Miles
0 0.5 1

Data Sources: City of Renton
Disclaimer: Features shown in this figure are for planning purposes and represent approximate locations. Engineering and/or survey accuracy is not implied.

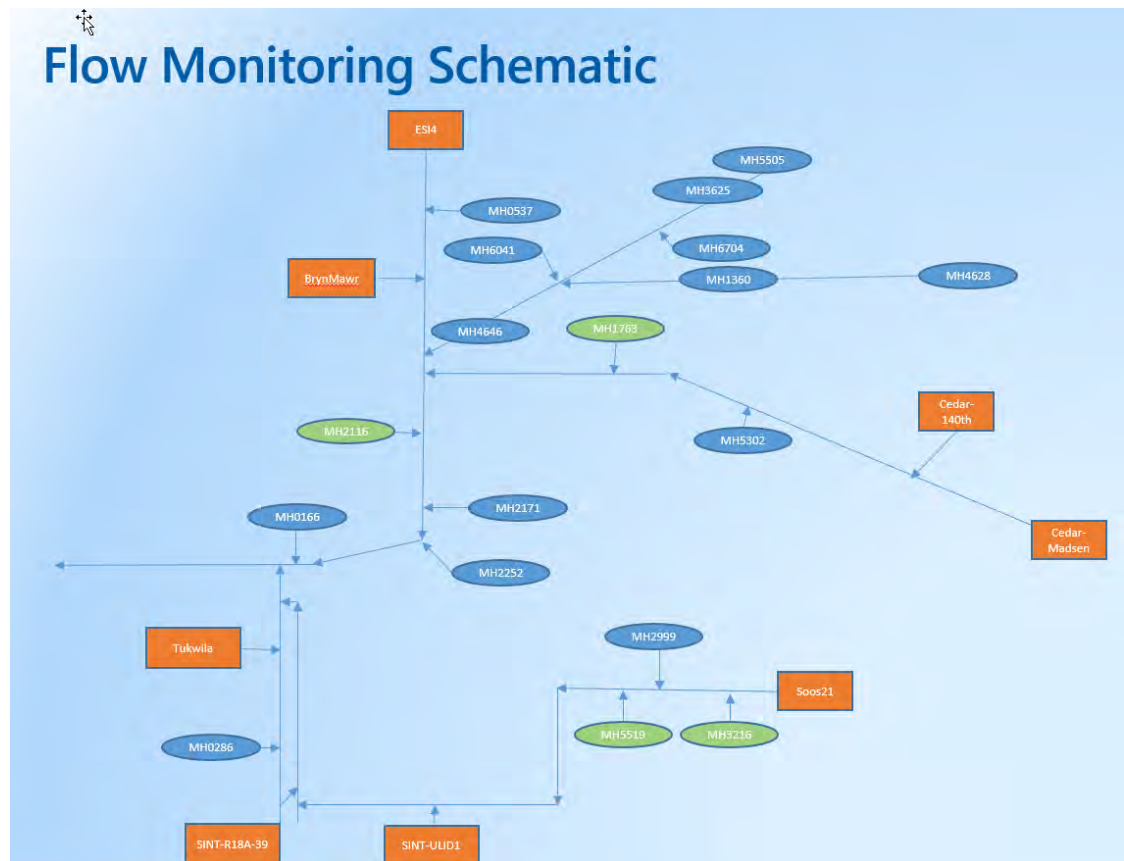

Figure 1.6 Flow Monitoring Schematic

1.3.1.2 Flow Monitoring Installation and Flow Calculation

ADS installed eighteen ADS Triton+™ Wireless Open Channel Flow Monitors. These meters use a pressure transducer to collect depth readings and ultrasonic Doppler sensors on the probe to determine the average fluid velocity. The flow meters used are non-contact meters that use radar to measure velocity and down-looking ultrasonic sensors to measure depth. ADS selected the optimal type of flow meter to use on a site-to-site basis based on the hydraulic characteristics at each site, as well as other factors.

ADS conducted an analysis of the data retrieved from each flow meter, and made adjustments as needed for calibration based on the field measurements. The flow at each meter was then calculated at 15-minute intervals based on the continuity equation:

$$Q = V \times A$$

where,

Q = Pipeline flow rate, cfs

V = Average velocity, ft/s

A = Cross sectional flow area, ft²

1.3.1.3 Rain Gauges

One rain gauge was installed by ADS to capture rainfall that occurred throughout the flow monitoring program.

1.3.2 Flow Monitoring Results

This section summarizes the results of the flow monitoring program, including DWF data, rainfall data, and WWF data. Data collected from flow meters MH0537 and MH1360 is presented throughout this TM as an example of the type of data and the results from the flow monitoring program. Refer to Attachment A for additional data summaries and other information associated with the remaining meter sites.

1.3.2.1 Dry Weather Flow Data

During the flow monitoring period, depth and velocity data were collected at each meter at 15-minute intervals. Carollo aggregated the 15-minute data to hourly data for use in the hydraulic model.

ADWF was developed using the driest days from the flow monitoring period defined based on the following set of minimum criteria:

- Less than 0.1 in of rain in the previous day.
- Less than 0.4 in of rain in the previous 3 days.
- Less than 1.0 in of rain in the previous 5 days.
- Selected days must exhibit average-day flows within 85 percent to 115 percent of the average-day flows of remaining dry days.
- In addition, those dry days that exhibited unusual flow patterns were not used to generate net dry day flow values for a basin.

Characteristic dry weather 24-hour diurnal flow patterns for each site were developed based on the hourly data. The hourly flow data were used to calibrate the hydraulic model for the observed ADWFs during the flow monitoring period.

Typically, a diurnal pattern with mostly residential uses has two peaks with the more pronounced peak following the wake-up hours of the day, and a less pronounced peak occurring in the evening. Commercial and industrial oriented-patterns, though they vary depending on the type of use, typically have more consistent higher flow patterns during business hours, and lower flows at night. Hourly patterns for weekday and weekend flows vary and were separated to better understand ADWF.

In addition, Carollo estimated the average weekday and weekend dry weather levels and velocities at each site from the data provided by ADS, which are used in the ADWF calibration.

Figure 1.7 illustrates a typical variation of weekday and weekend flow in the City, which is based on the data collection from MH0537. Similar graphics associated with the remaining sites are included in Attachment A. Table 1.2 summarizes the ADWFs at each meter, and the different components of ADWF at each meter.

Table 1.2 Dry Weather Flow Summary

Meter ID/ Manhole ID	Average Daily Flow (mgd)	Minimum Daily Flow (mgd)	Maximum Daily Flow (mgd)	Base Infiltration	Base Infiltration/ ADWF (%)
MH0166	0.076	0.036	0.138	0.011	13
MH0286	0.379	0.288	0.490	0.273	71
MH0537	1.676	1.093	2.112	0.866	52
MH1360 (1360 – 4628)	0.216	0.036	3.311	0.000	<5
MH1763	0.886	0.378	1.243	0.287	32
MH2116	3.033	2.167	3.476	1.658	55
MH2171	0.962	0.493	1.464	0.385	39
MH2252	3.433	2.271	4.456	1.629	48
MH2999	0.928	0.646	1.136	0.561	61
MH3216	0.263	0.117	0.371	0.106	40
MH3625 (3625 – 5505)	1.717	0.698	2.663	0.299	17
MH4628	0.864	0.623	1.041	0.549	64
MH4646	1.539	0.903	1.215	0.834	53
MH5302	8.928	5.670	10.655	3.294	37
MH5505	1.116	0.880	1.261	0.789	71
MH5519	1.680	0.985	2.039	0.748	45
MH6041	0.247	0.090	0.352	0.074	30
MH6704	0.607	0.334	0.839	0.280	46

1.3.2.2 Rainfall Data

An important part of the study is the collection and analysis of rainfall data. One tipping bucket type rain gauge was temporarily set up for this LRWWMP. Four significant rainfall events occurred during the course of the flow monitoring period, as well as a few other relatively minor events. The rainfall data recorded over the course of the flow monitoring program is illustrated in Figure 1.8. Figure 1.9 illustrates the total accumulation of rainfall over the course of the flow monitoring period for the ADS tipping bucket type rain gauge. Table 1.3 summarizes the total rainfall recorded at the ADS rain gauge during the main rainfall event, as well as over the entire flow monitoring period.

Table 1.3 Rainfall Event Summary for Calibration (2017-2018)

Event ID	Start Date	End Date	Duration (hours)	Total Rainfall (in)	Avg. Rainfall (in/day)	Peak Rainfall (in/hr)
1	12/26/17	1/3/18	216	2.02	0.22	0.16
2	1/23/18	2/7/18	384	4.45	0.28	0.23
3	4/6/18	4/22/18	408	5.11	0.30	0.27

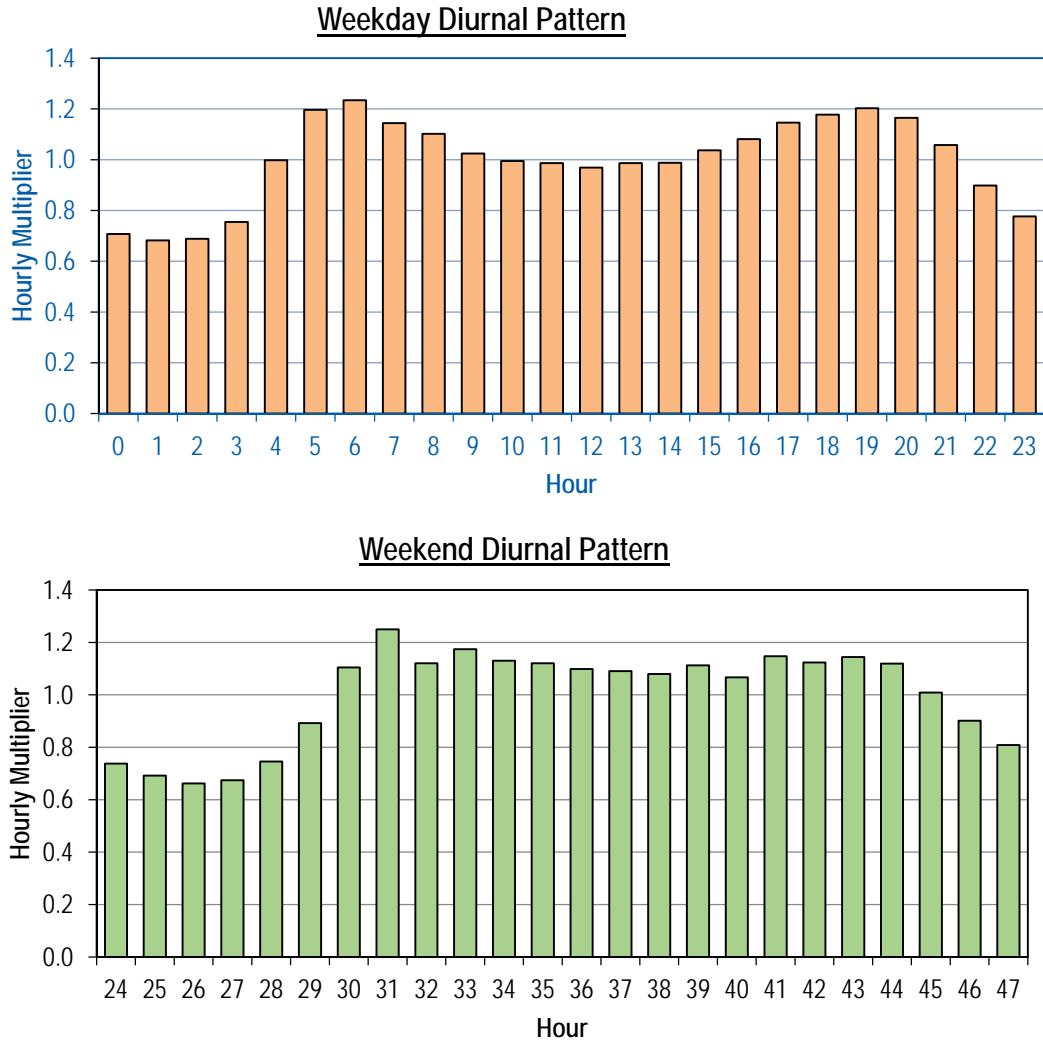

Figure 1.7 Typical Weekday vs Weekend Dry Weather Flow Variation (MH0537)

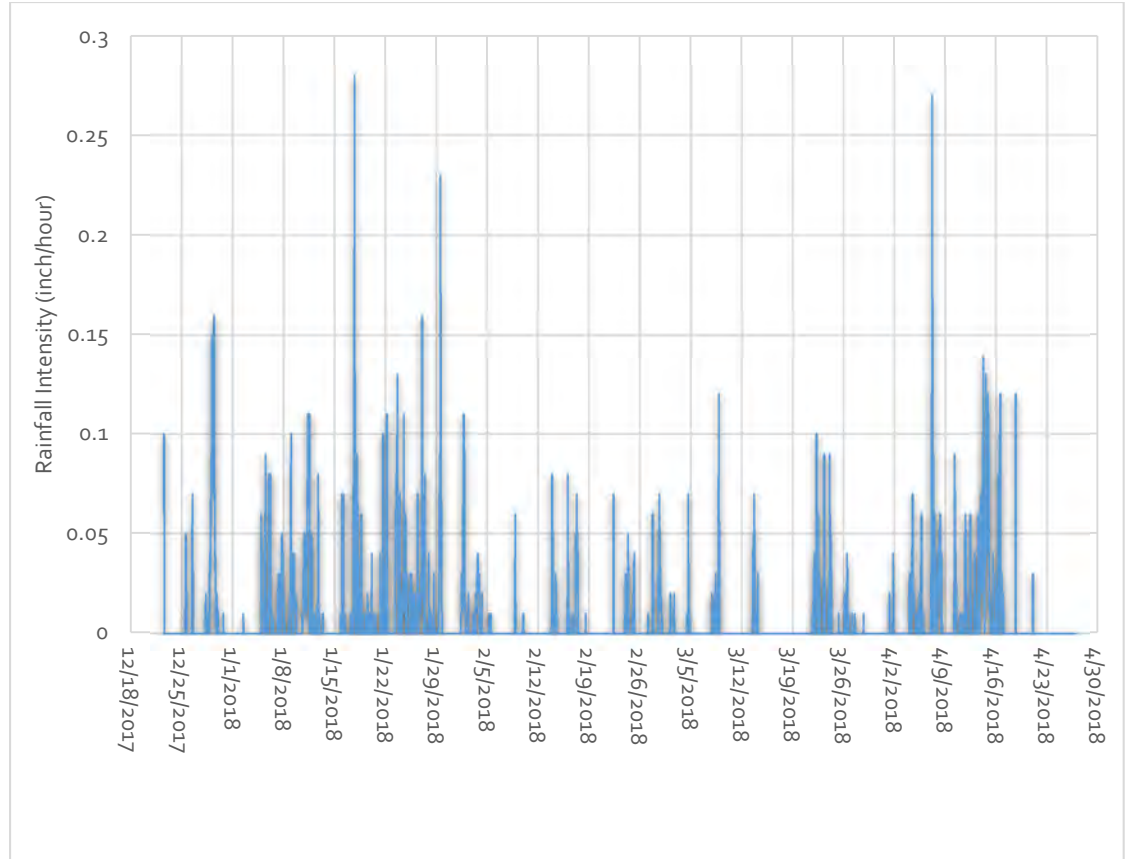

Figure 1.8 Typical Rainfall Activity over Flow Monitoring Period

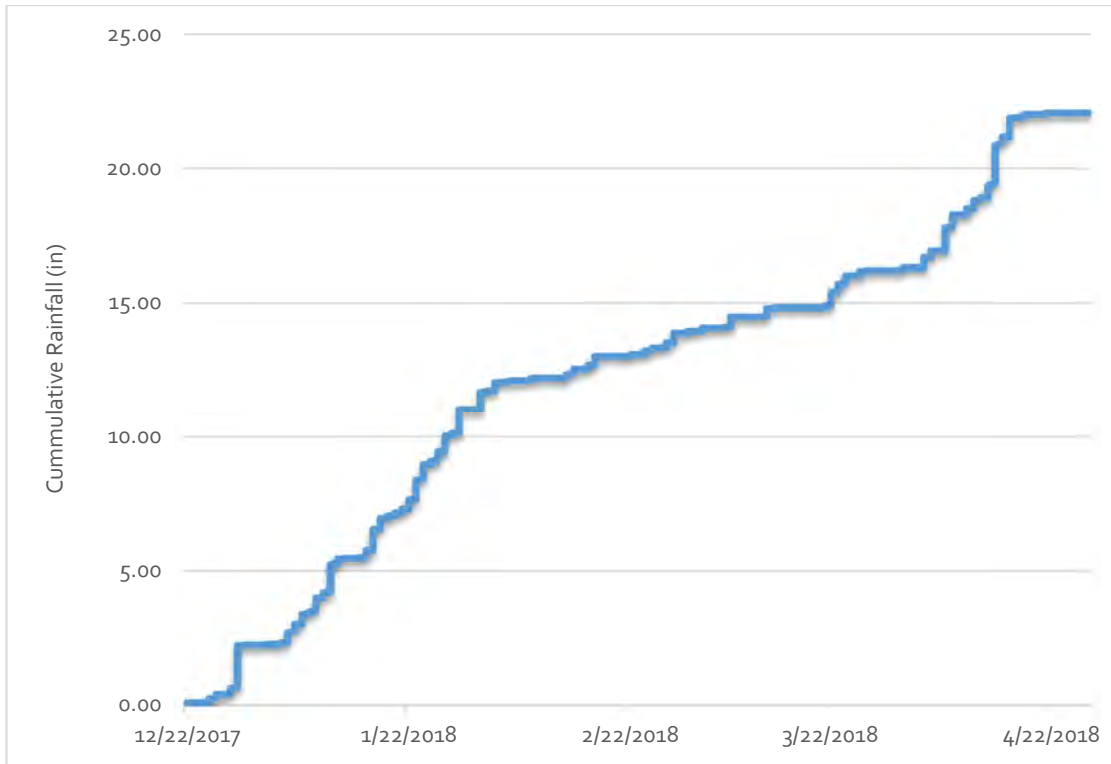

Figure 1.9 Rainfall Accumulation Plot

The storms presented in Table 1.3, correspond to the most significant rainfall events that were then used for model calibration. Additional storms did provide data in terms of the collection system's I/I response to WWF events, and is appropriate for I/I analysis and model calibration purposes.

1.3.2.3 Wet Weather Flow Data

The flow monitoring data were also evaluated to determine how the collection system responds to wet weather events. As mentioned above, the flow monitoring program captured three main rainfall events. The rainfall event that occurred on April 15, 2018 was associated with the largest I/I response during the flow monitoring period, and is the most appropriate to be used for wet weather flow analysis.

Figure 1.10 shows an example of the wet weather response at MH1360 during the April 2018 rainfall event. This figure also illustrates the volume of I/I that entered the system from the collection system upstream of MH1360. The light grey line is the base sanitary flow while the dark blue line is the measured flow from the flow monitoring period. As can be seen in the figure, discernible amounts of I/I do enter the system during wet weather events. Similar graphs were generated for the remaining monitoring sites and can be found in Attachment B, as well as capacity indicators in the collection system during the flow monitoring period, such as the depth vs diameter (d/D) ratio.

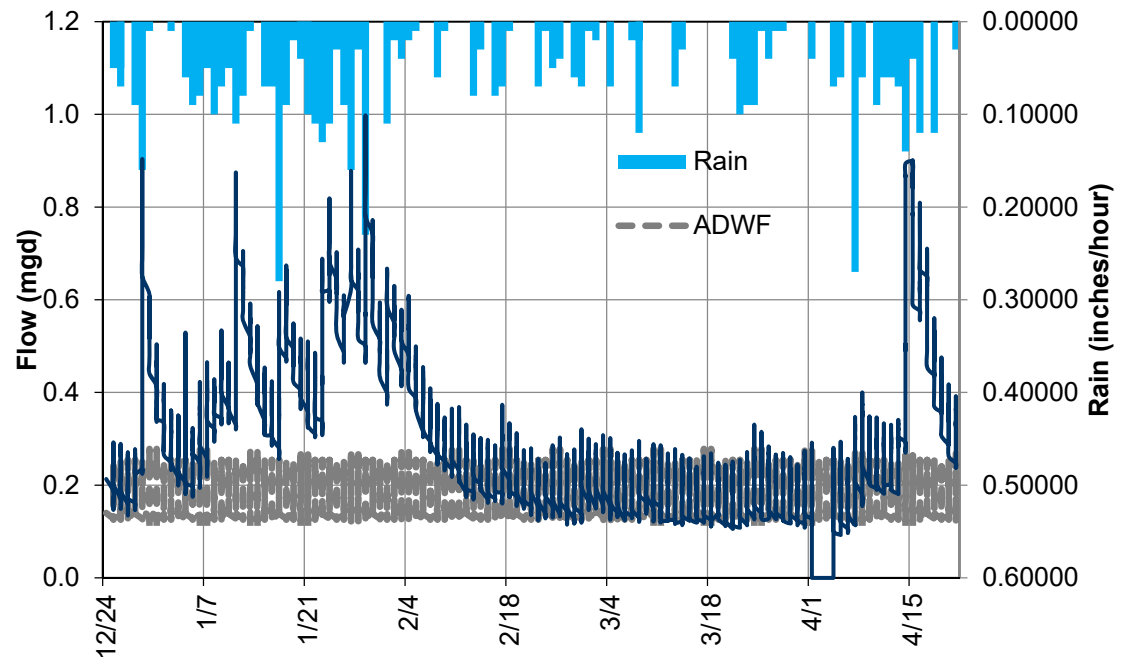

Figure 1.10 Example of Wet Weather Flow Response (MH1360)

1.3.3 Dry Weather Flow Projections

Developing an accurate estimate of the future quantity of wastewater generated at build-out of the collection system is an important step in maintaining and sizing sewer system facilities, for both existing conditions and future scenarios.

GWI can be estimated for a sewer system by comparing ADWF and WWF at the various flow monitoring locations. To estimate ADWF for more specific areas, such as individual wastewater basins, ADWFs are typically estimated based on the PE's contributing to flows and flow factors developed for each land use type. These values were considered unchanged and PE's were taken from Stantec's 2016 Model Update Report, Appendix F. This method is developed based on the assumption that areas with similar land uses, such as low density residential parcels, produce equivalent quantities of wastewater flow. System-wide flows can be compared to known flows at flow monitors, or at the treatment plant to verify accuracy. This method of estimating GWI is an industry standard for planning and provides sufficiently accurate data for planning purposes.

1.3.3.1 Existing Average Dry Weather Flows and Existing Flow Factors

This section presents the existing flow data available for this LRWWMP. Overall ADWF, BWP, and GWI were estimated using data from the Flow Monitoring Program for each of the eighteen flow monitoring basins. After reviewing the flow monitoring data, BWP and BI were estimated for each flow monitoring basin and were presented in Section 1.3.2.3 in Table 1.3.

ADWFs were developed for each of the eighteen flow meters. Table 1.4 lists the flow factors and ADWF developed, while Figure 1.7 illustrates a typical variation of weekday and weekend flow in the system, which is based on the data collection from Meter MH0537. Similar graphs for each meters site can be found in Attachment A.

Table 1.4 Flow Meter Basins ADWF Development

Meter ID	Total PE ⁽¹⁾	Flow Factor (ft ³ /PE/day)	Existing ADWF (mgd)	Future PE	Future ADWF (mgd)
MH0166	286	5.68	0.01	645	0.03
MH0286	1,184	7.44	0.07	2,048	0.17
MH0537	4,571	9.27	0.32	7,654	0.51
MH1360	2,019	13.59	0.21	6,135	0.09
MH1763	3,991	5.7	0.17	3,757	0.20
MH2116	4,027	19.03	0.57	7,397	0.72
MH2171	2,207	10.49	0.17	3,307	0.29
MH2252	11,405	7.68	0.66	18,528	1.08
MH2999	2,104	11.32	0.18	2,150	0.25
MH3216	1,673	3.9	0.05	2,130	0.08
MH3625	8,600	8.53	0.55	13,843	0.74
MH4628	1,202	18.38	0.17	1,819	0.24
MH4646	2,336	11.73	0.21	2,805	0.37
MH5302	2,805	80.51	1.69	7,253	1.25
MH5505	2,186	12.92	0.21	3,137	0.30
MH5519	3,338	12.52	0.31	4,564	0.46
MH6041	1,265	4.79	0.05	1,729	0.05
MH6704	2,723	5.81	0.12	2,858	0.17
Unmetered Basins	69,636		3.25	145,172	6.31
Modeled Total	127,558		8.97	236,931	13.3

Notes:

(1) Total PE is not directly equivalent to City's population, Chapter 4, Stantec 2016 Model Update Report – Appendix F.

1.3.3.2 Projected Dry Weather Flows

Developing an accurate estimate of the future quantity of wastewater generated at build-out of the collection system is an important step in maintaining and sizing sewer system facilities, for both existing conditions and future scenarios. GWI can be estimated for a sewer by comparing ADWF and WWF at the various flow monitoring locations. To estimate ADWF for more specific areas, such as individual wastewater basins, ADWFs are typically estimated based on the PE contributing to flows and flow factors developed for each land use type.

The future build-out ADWFs were developed by projecting the planning GWI to the build-out planning year land uses. The PE's for each catchment were developed for existing and buildout conditions and a constant flow factor was used to relate this to ADWF. Additional information can be found in Chapter 4 of the LRWWMP and Attachment F – Stantec's Model Update Report.

1.3.4 Wet Weather Flow Projections

1.3.4.1 Peak Wet Weather Flows and Design Storms

Peak wet weather flows (PWWF) in a wastewater collection system are caused by rainfall dependent I/I. Peak hour flows can result in flows more than ten times the GWI, causing utilities to construct high-capacity infrastructure to convey and treat these extraneous flows.

Existing and projected PWWFs are predicted using the hydraulic model and design storm used for this LRWWMP. This analysis uses four separate multi-day, 20-30 year recurrence design storms, illustrated in Figure 1.11. These storms were identified in the 2012 King County (KC) I/I Study and correspond to the recurrence interval within historical KC rainfall. To represent typical winter Pacific Northwest antecedent conditions, typical rainfall was added from historical data prior to the design storm in the hydraulic model. Further detail on the development of the design storm can be found in Appendix H, TM 2.

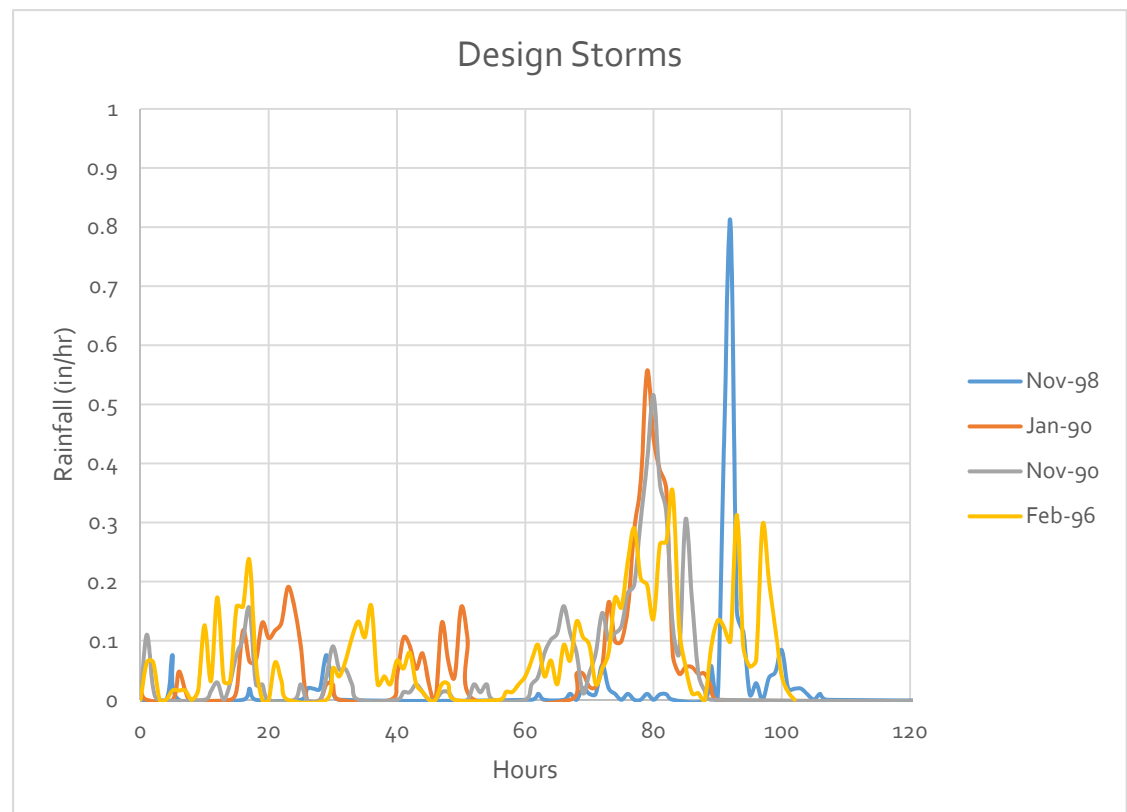

Figure 1.11 LRWWMP Design Storms

1.3.4.2 Future PWWF Assumptions

To predict future PWWF, I/I in the future service area must be defined. A direct inflow technique is used. Instead of simulating I/I using an I/I unit hydrograph, I/I is simulated by assuming a constant I/I flow factor per acre of new development. I/I flow factors can range from 1,000 to over 10,000 gallons per day per acre (gpd/ac) in the northwest. An I/I Flow Factor of 1,500 gpd/ac was selected for estimating I/I in areas of new development to reflect improved construction methods and integrity of new materials. Additionally, this value also meets the Department of Environmental Quality (DEQ) recommendation.

Existing pipe I/I is assumed to degrade over time, for the purpose of this LRWWMP, a value of 7 percent degradation per 10 years was used. This corresponded to a 28 percent degradation for build out conditions in the model. The PWWF for buildout and current conditions at each of the monitored sites and the entire system is shown in Table 1.5.

Table 1.5 Wet Weather Flow Development

Meter ID	Current Peak Wet Weather Flow (mgd)	Buildout Peak Wet Weather Flow (mgd)
MH0166	1.86	2.19
MH0286	0.31	0.33
MH0537	0.87	0.98
MH1360	1.93	2.36
MH1763	1.01	1.24
MH2116	3.71	4.03
MH2171	1.31	1.59
MH2252	4.77	5.81
MH2999	0.87	1.02
MH3216	0.30	0.36
MH3625	2.22	2.51
MH4628	1.47	1.82
MH4646	0.55	0.60
MH5302	3.44	4.75
MH5505	0.91	1.01
MH5519	0.81	0.90
MH6041	0.55	0.68
MH6704	0.55	0.64
Unmetered Basins	26.78	31.94
Modeled Total	54.20	64.74

Attachment A
ADS 2018-2019 FLOW MONITORING REPORT

Renton, WA

**Temporary Flow Monitoring and RDII
Analysis**

December 22, 2017 – April 22, 2018

**Report Submitted
May 29, 2018**

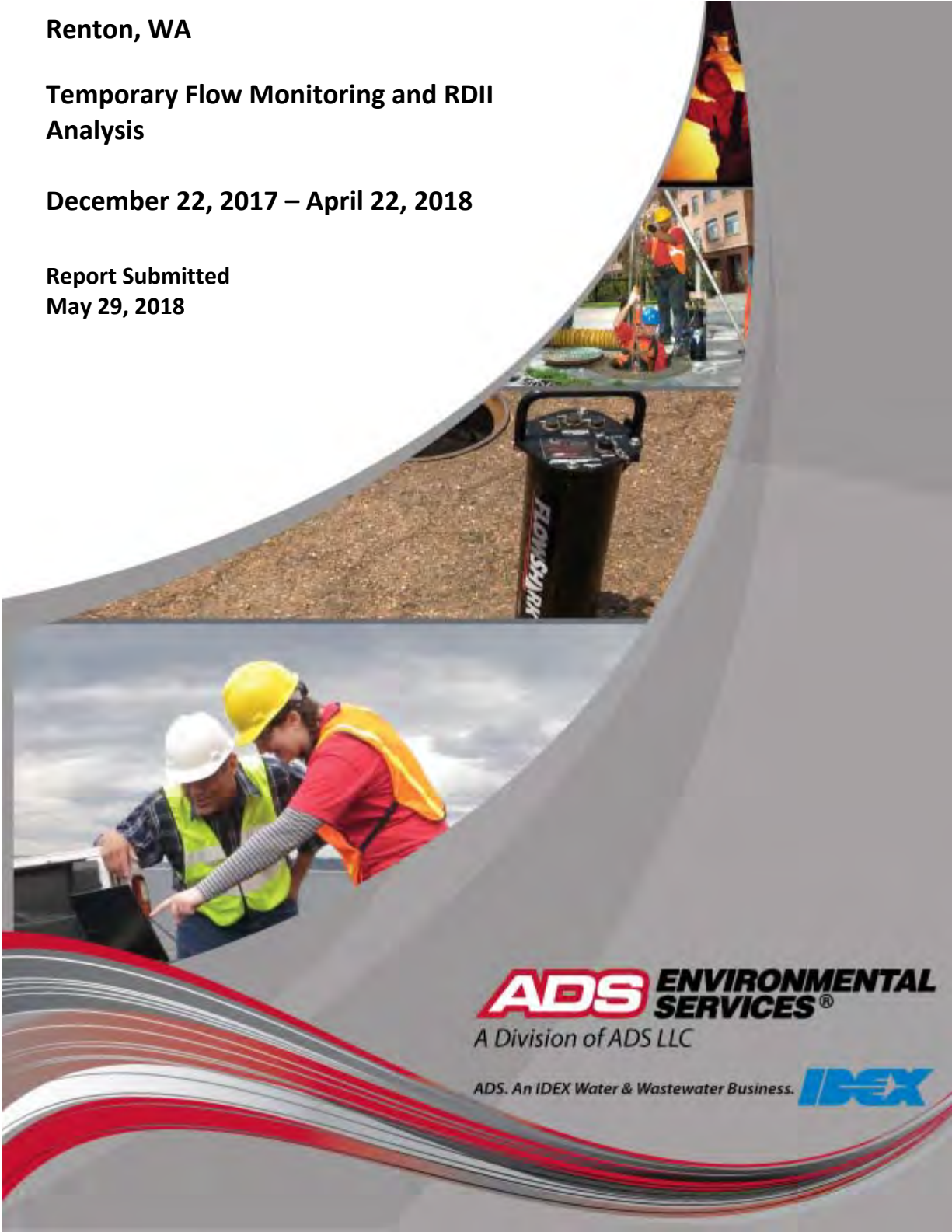

**ADS ENVIRONMENTAL
SERVICES®**

A Division of ADS LLC

ADS. An IDEX Water & Wastewater Business. **IDEX**



May 29, 2018

Daniel Reisinger, P.E.

Carollo Engineering

1218 Third Ave, Suite 1600

Seattle, WA 98101

Re: City of Renton Results and Analysis of 2017/18 Flow Monitoring Data

Dear Mr. Reisinger,

Thank you for the opportunity to complete this flow monitoring work effort for Renton, WA. Please find attached the electronic report of results and conclusions based on the flow monitoring study conducted between December 2017 and April 2018.

Hydrographs and scattergraphs of the data are available in the report. The Excel raw and edited data is being provided in addition to the report.

Daniel, we certainly look forward to other opportunities to work on wastewater flow monitoring projects as they arise. If you have any questions regarding the content of this report, please do not hesitate to call me at (206) 255 6904.

Sincerely,

A handwritten signature in blue ink, enclosed within a blue circular outline. The signature appears to be 'Mike Pina'.

Mike Pina

Senior Project Manager

mpina@idexcorp.com

Introduction

Background

Carollo Engineers entered into agreement with ADS Environmental Services to conduct flow monitoring at (18) eighteen metering points and (1) rain gauge located in the City of Renton, WA. The study was contracted for a four month monitoring period. The objective of this study was to measure depth, velocity, and quantify flows and identify capacity restrictions. A basin map and drawings for the pump stations are available in the appendix.

Project Scope

The scope of this study involved using temporary flow monitors to quantify wastewater flow at the designated locations. Specifically, the study included the following key components.

- Investigate the proposed flow-monitoring sites for adequate hydraulic conditions
- Flow monitor installations
- Flow monitor confirmations and data collections
- Flow data analysis
- I/I Analysis

Equipment installation was accomplished starting in December 22, 2017. The monitoring period was completed on April 22, 2018.

Equipment and Methodology

Flow Quantification Methods

There are two main equations used to measure open channel flow: the Continuity Equation and the Manning Equation. The Continuity Equation, which is considered the most accurate, can be used if both depth of flow and velocity are available. In cases where velocity measurements are not available or not practical to obtain, the Manning Equation can be used to estimate velocity from the depth data based on certain physical characteristics of the pipe (i.e. the slope and roughness of the pipe being measured). However, the Manning equation assumes uniform, steady flow hydraulic conditions with non-varying roughness, which are typically invalid assumptions in most sanitary sewers. The Continuity Equation was used exclusively for this study.

Continuity Equation

The Continuity Equation states that the flow quantity (Q) is equal to the wetted cross-sectional area (A) multiplied by the average velocity (V) of the flow.

$$Q = A * V$$

This equation is applicable in a variety of conditions including backwater, surcharge, and reverse flow. Most modern flow monitoring equipment, including the ADS Models, measure both depth and velocity and therefore use the Continuity Equation to calculate flow quantities.

Flow Monitoring Equipment

The ADS Triton+ monitor was selected for this project. This flow monitor is an area velocity flow monitor that uses both the Continuity and Manning's equations to measure flow.

The ADS Triton+ monitor consists of data acquisition sensors and a battery-powered microcomputer. The microcomputer includes a processor unit, data storage, and an on-board clock to control and synchronize the sensor recordings. The monitor was programmed to acquire and store depth of flow and velocity readings at 1-minute intervals.

The Triton+ monitor features cross-checking using multiple technologies in each sensor for continuous running of comparisons and tolerances. The sensor option used for this project was the peak combo sensor.

ThePeakComboSensor installed at the bottom of the pipe includes three types of data acquisition technologies. The *up looking ultrasonic depth* uses sound waves from two independent transceivers to measure the distance from the sensor upward toward the flow surface; applying the speed of sound in the water and the temperature measured by sensor to calculate depth. The *pressure depth* is calculated by using a piezo-resistive crystal to determine the difference between hydrostatic and atmospheric pressure. The pressure sensor is temperature compensated and vented to the atmosphere through a desiccant filled breather tube. To obtain *peak velocity*, the sensor sends an ultrasonic signal at an angle upward through the widest cross-section of the oncoming flow. The signal is reflected by suspended particles, air bubbles, or organic matter with a frequency shift proportional to the velocity of the reflecting objects. The reflected signal is received by the sensor and processed using digital spectrum analysis to determine the peak flow velocity.

Installation

Installation of flow monitoring equipment typically proceeds in four steps. First, the site is investigated for safety and to determine physical and hydraulic suitability for the flow monitoring equipment. Second, the equipment is physically installed at the selected location. Third, the monitor is tested to assure proper operation of the velocity and depth of flow sensors and verify that the monitor clock is operational and synchronized to the master computer clock. Fourth, the depth and velocity sensors are confirmed and line confirmations are performed. A typical flow monitor installation is shown in Figure 1.

The installations depicted in Figure 1 are typical for circular or oval pipes up to approximately 104-inches in diameter or height. In installations into pipes 42-inches or less in diameter, combo sensors are mounted on an expandable stainless steel ring and installed one to two pipe diameters upstream of the pipe/manhole connection in the incoming sewer pipe. This reduces the effects of turbulence and backwater caused by the connection. In pipes larger than 42 inches in diameter, a special installation is made using two sections of the ring installed one to two feet upstream of the pipe/manhole connection; one bolted to the crown of the pipe for the surface combo sensor and the other bolted to the bottom of the pipe (bolts are usually placed just above the water line) to hold the peak combo sensor.

Figure 1 Typical Installation



Large Pipe (> 42" Diameter)



Small Pipe (8" to 42" Diameter)

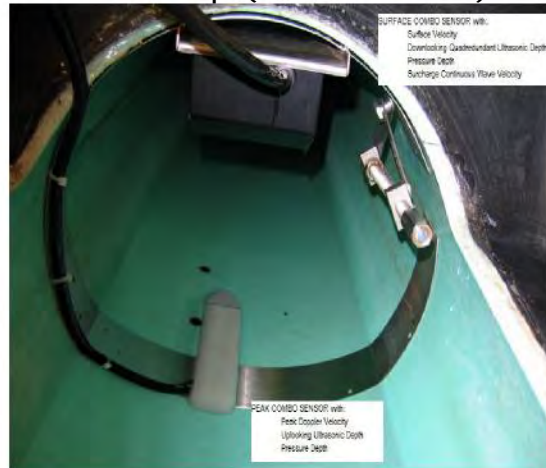

Data Collection, Confirmation, and Quality Assurance

During the monitoring period data collects from the meters were done remotely via wireless connection. Quality assurance taken to assure the integrity of the data collected included:

- **Measure Power Supply:** The monitor is powered by a dry cell battery pack. Power levels are recorded and battery packs replaced, if necessary. A separate battery provides back-up power to memory, which allows the primary battery to be replaced without the loss of data.
- **Perform Pipe Line Confirmations and Confirm Depth and Velocity:** Once equipment and sensor installation is accomplished, a member of the field crew descends into the manhole to perform a field measurement of flow rate, depth and

velocity to confirm they are in agreement with the monitor. Since the ADS V-3 velocity sensor measures peak velocity in the wetted cross-sectional area of flow, velocity profiles are also taken to develop a relationship between peak and average velocity in lines that meet the hydraulic criteria.

Measure Silt Level: During site confirmation, a member of the field crew descends into the manhole and measures and records the depth of silt at the bottom of the pipe. This data is used to compute the true area of flow.

Confirm Monitor Synchronization: The field crew and data analyst checks the flow monitor's clock for accuracy.

Upload and Review Data: Data collected by the monitor is uploaded and reviewed for comparison with previous data. All readings are checked for consistency and screened for deviations in the flow patterns, which may indicate system anomalies or equipment failure.

Data Analysis and Presentation

Data Analysis

A flow monitor is typically programmed to collect data at either 15-minute or 5-minute intervals throughout the monitoring period. The monitor stores raw data consisting of (1) the updepth (distance from sensor to top of flow) for each active ultrasonic depth sensor, (2) the peak velocity and (3) the pressure depth. The data is imported into ADS's proprietary software and is examined by a data analyst to verify its integrity. The data analyst also reviews the daily field reports and site visit records to identify conditions that would affect the collected data.

Velocity profiles and the line confirmation data developed by the field personnel are reviewed by the data analyst to identify inconsistencies and verify data integrity. Velocity profiles are reviewed and an average to peak velocity ratio is calculated for the site. This ratio is used in converting the peak velocity measured by the sensor to the average velocity used in the Continuity equation. The data analyst selects which depth sensor entity will be used to calculate the final depth information. Silt levels present at each site visit are reviewed and representative silt levels established.

Occasionally the velocity sensor's performance may be compromised resulting in invalid readings sporadically during the monitoring period. This is generally caused by excessive debris (silt) blocking the sensor's crystals, shallow flows ($\sim < 2''$) that may drop below the top of the sensor or very clear flows lacking the particles needed to measure rate. In order to use the Continuity equation to quantify flow during such brief (in respect to overall study duration) periods of velocity sensor "fouling", a Sr. Analyst and/or Engineer will use the site's historical pipe curve (depth vs. velocity) data along with valid field confirmations to reconstitute and replace the false velocity recordings with expected velocity readings for a given historical depth along the curve.

Selections for the above parameters can be constant or can change during the monitoring period. While the data analysis process is described in a linear manner, it often requires an iterative approach to accurately complete.

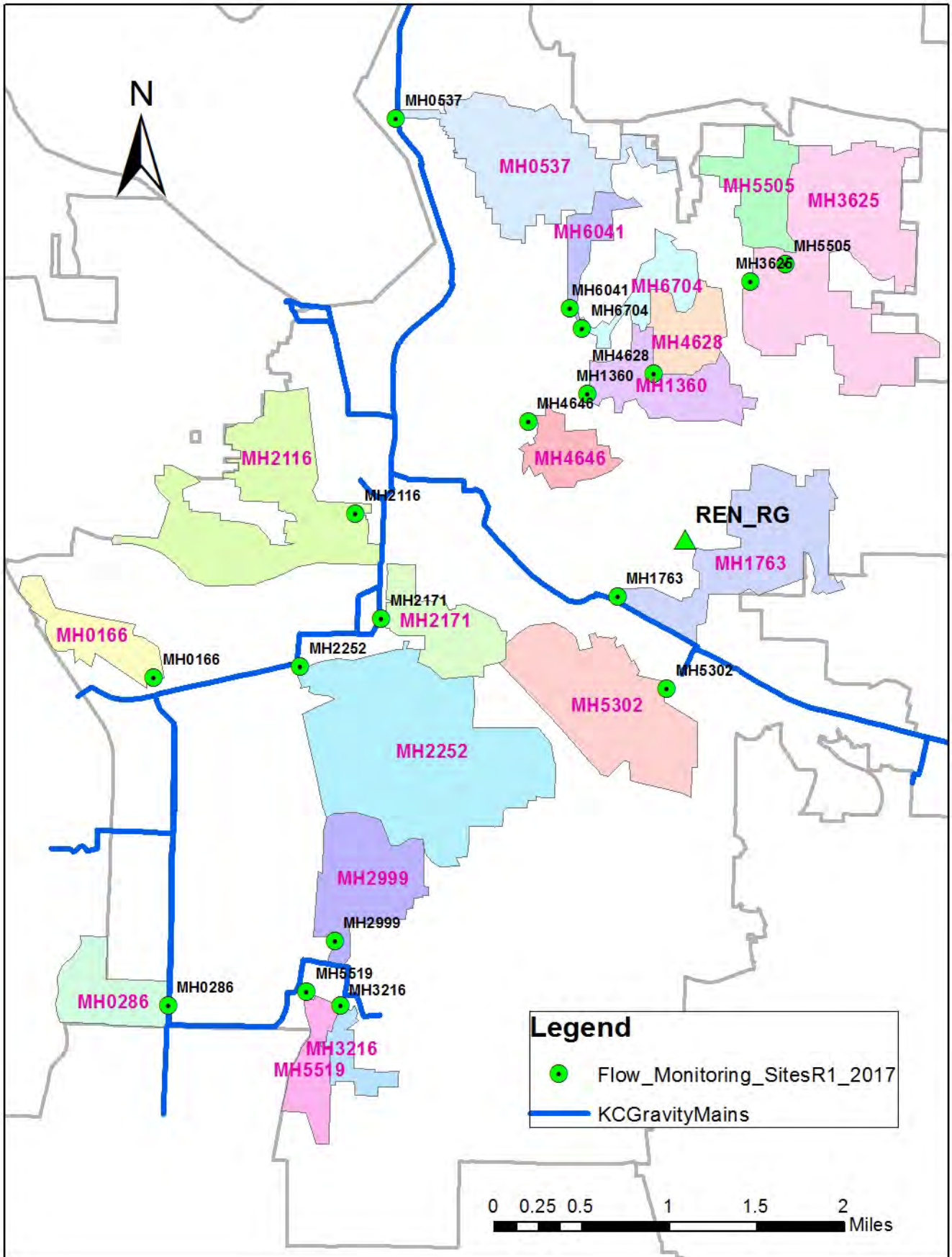

REN_MH0166

Located At: Springbrook Trail, Renton (see attached site report for details)
Monitoring Period: December 22, 2017 – April 22, 2018
Pipe Dimensions: 11.5"
Finalized Silt Level: 0 mm

Site Data Characteristics: This site is located in a sanitary sewer pipe. The scattergraph indicates site operated in free flow conditions. The site did surcharge during the monitoring period. The dry weather data plots below the Froude =1 curve indicating subcritical flow.

Site Data Bias & Editing: The depth and velocity measurements recorded by the flow monitor were consistent with field confirmations conducted to date and supported the relative accuracy of the flow monitor at this location. The finalized depth data utilized the downward ultrasonic sensor.

Site Data Uptime: The data uptime achieved during the monitoring period is provided in the table below. Based upon the quality and consistency of the observed flow depth and velocity data, the Continuity equation was used to calculate the flow rate for the monitoring period.

Entity	Percentage Uptime Raw	Percentage Uptime Final
Depth (in)	100%	100%
Velocity (f/s)	100%	100%
Quantity (mgd)	100%	100%

Site Data Summary: The average flow depth, velocity, and quantity data observed during the monitoring period along with observed minimum and maximum data, are provided in the following table. The minimum and maximum rates recorded in the tables are based on 5-minute data intervals.

Item	Depth (in)	Velocity (f/s)	Quantity (mgd)	% Full
Minimum	0.65	0.00	0.000	6%
Maximum	28.29	3.47	1.429	100%
Average	1.74	0.77	0.070	15%

Renton.Carollo.I&I.WA17

Flow Monitoring Site Report



Site Name

REN_MH0166

Site Address /Location: Springbrook Trail, Renton. East of Wastewater Treatment Area.

Monitor Series

TRITON+

Location Type

Temporary

Site Access Details: Access / Park SW 7th St Outside Treatment plant and walkdown trail/ bike path. Located just off trail.

Latitude: 47.470098°

Longitude: -122.235586°

Pipe Size (H x W)

12.00" x 12.00"

Pipe Shape

Circular

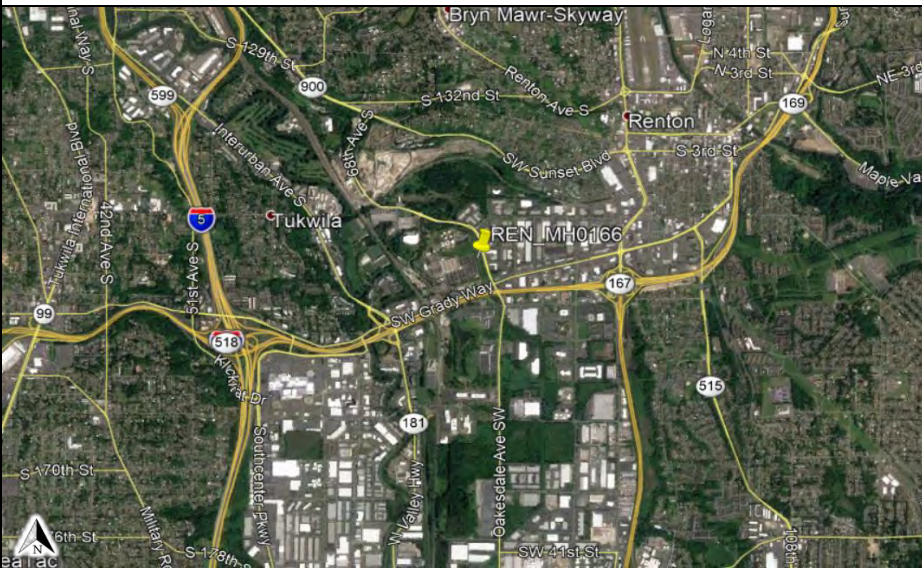

Manhole #

MH0166

System Characteristics

Other

Access

Walk (Wooded)

Traffic

Light



Installation Information

Installation Date:

12.20.17

Installation Type:

Doppler Standard Ring and Crank

Monitoring Location (Sensors):

Upstream 0-5 FT

Monitor Location:

Manhole

Sensors / Devices:

Peak Combo (CS4), Smart Depth (CS5)

Pressure Sensor Range (psi)

0 - 5 psi

Installation Confirmation:

Confirmation Time:

10:00:00 AM

Pipe Size (HxW)

12.00" x 12.00"

Depth of Flow (Wet DOF) (in)

~3.50"

Range (Air DOF) (in)

Downlooker Physical Offset (in)

1.25"

Measurement Confidence (in)

0.25"

Peak Velocity (fps)

~ 1 FPS

Velocity Sensor Offset (in)

Silt (in)

0

Silt Type

Hydraulic Comments:

Smooth, slow flow

Manhole / Pipe Information:

Manhole Depth (Approx. FT):

~10'

Manhole Configuration

Single

Manhole Material:

Concrete

Manhole Condition:

Good

Manhole Opening Diameter (in)

20"

Manhole Diameter (Approx.):

20"

Manhole Cover

Unbolted

Manhole Frame

Normal

Active Drop Connections

No

Air Quality:

Normal

Pipe Material

PVC

Pipe Condition:

Good

Communication Information:

Communication Type

Wireless

Antenna Location

Manhole Pick / Vent Hole

Additional Site Info. / Comments:

Manhole frame slightly elevated. White fungus of some kind growing in pipe.

ADS Project Name: Renton.Carollo.I&I.WA17

ADS Project Number: 22275.11.325

Additional Photos

Upstream



Downstream



Overflow



Top Down



Location



Location



Location

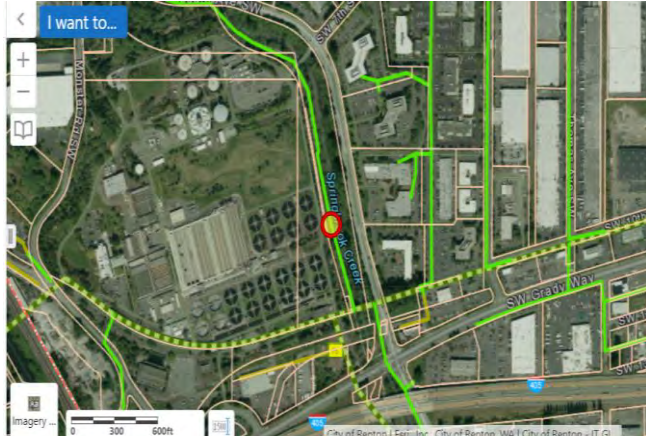

- Flow Direction
- ⊗ Monitoring Point

HYDROGRAPH REPORT

REN_MH0166

Flow Monitor
REN_MH0166

Pipe Height
11.50 in

Report Period
12/22/2017
To
4/22/2018

Legend
— Depth
— Velocity
— Rain

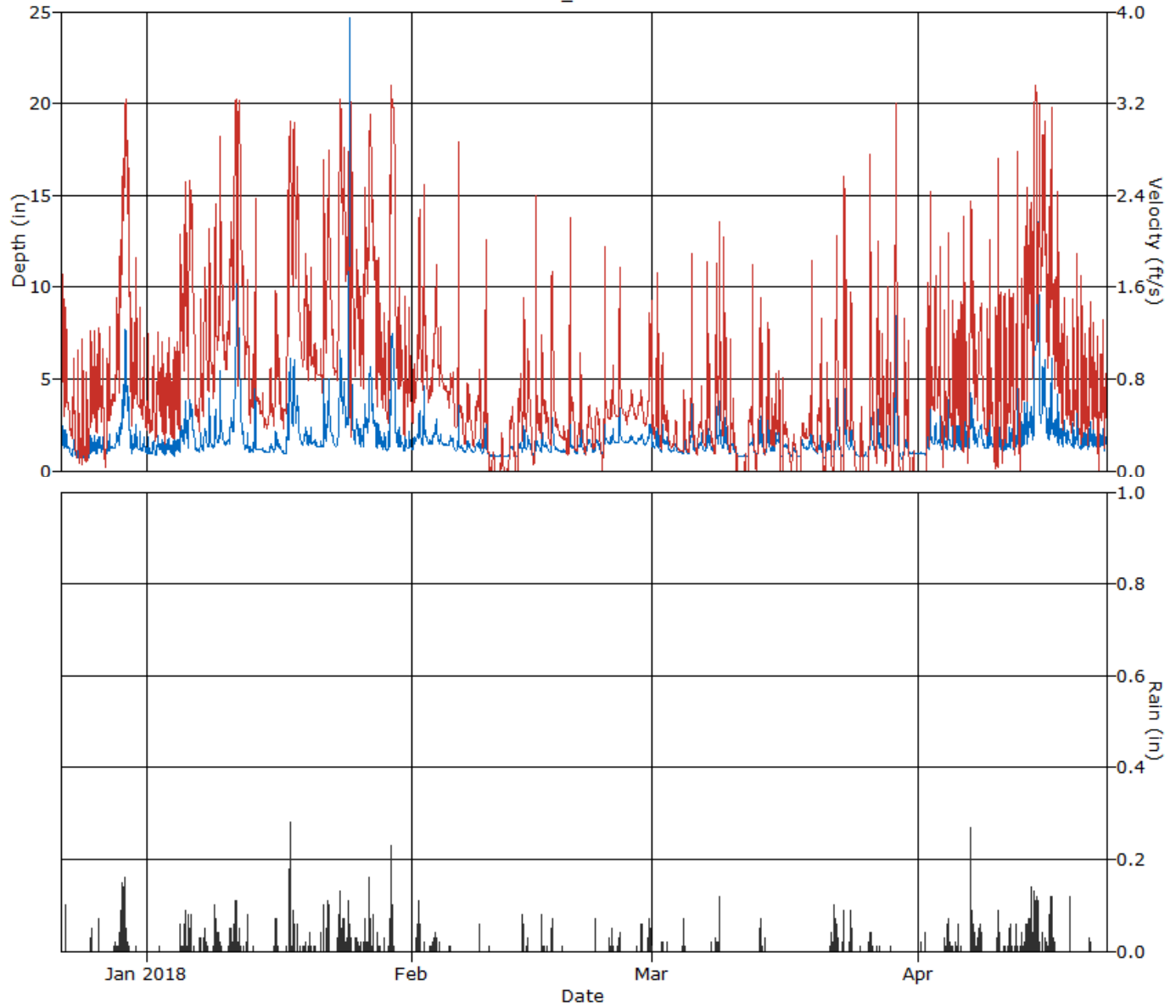

HYDROGRAPH REPORT

REN_MH0166

Flow Monitor
REN_MH0166

Pipe Height
11.50 in.

Report Period
12/22/2017
To
4/22/2018

Legend
— Quantity
— Rain

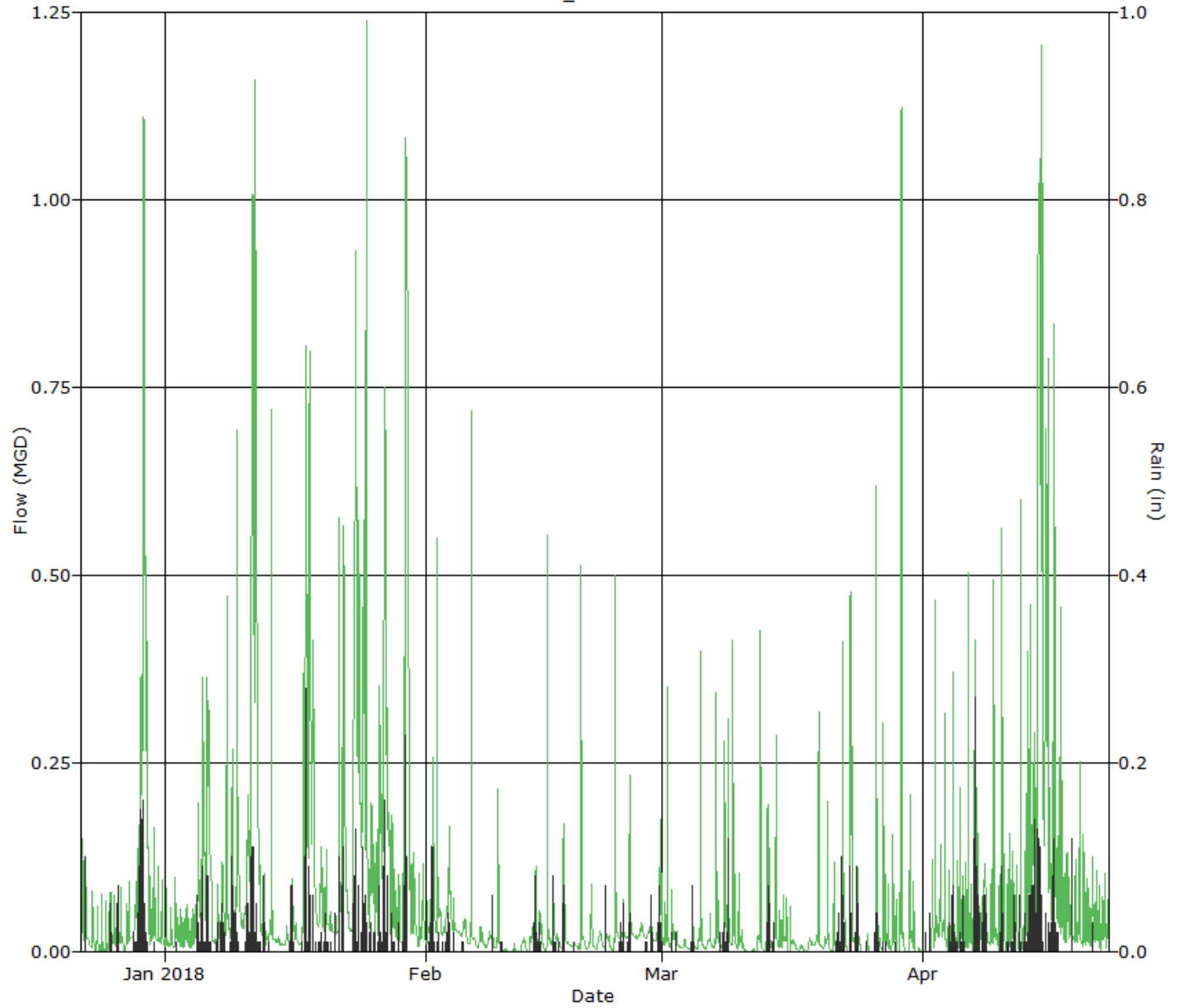

SCATTERGRAPH REPORT

REN_MH0166

Flow Monitor
REN_MH0166

Pipe Height
11.50 in

Report Period
12/22/2017
To
4/22/2018

Legend
○ Depth - Velocity
--- Iso-Q™
--- Silt
▼ Min-Max Depth

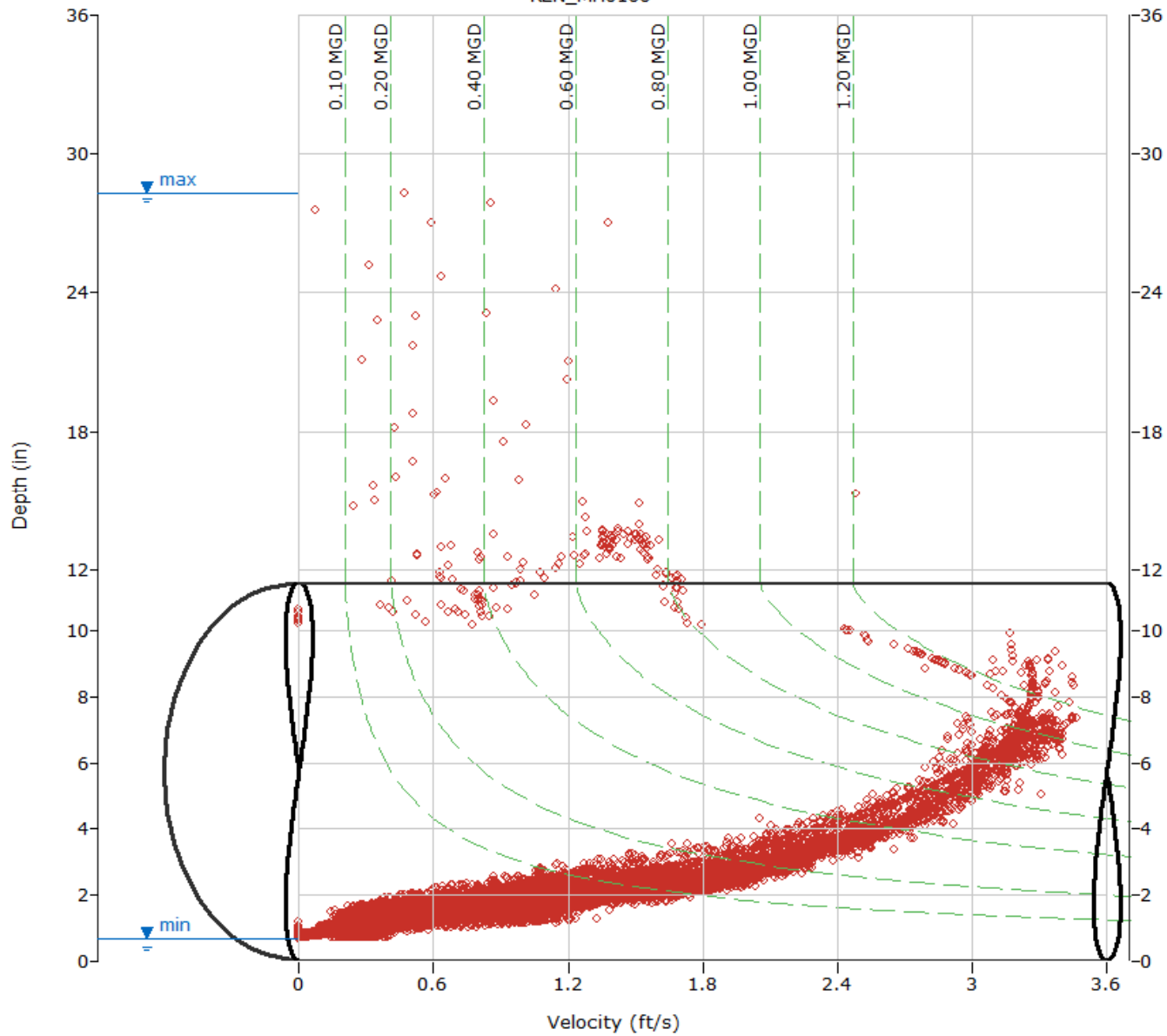

ADS Environmental Services

Pipe Height: 11.50

Date	REN_MH0166\mp1\DFINAL (inches)					REN_MH0166\mp1\VFINAL (feet/sec)					REN_MH0166\mp1\QFINAL (MGD - Total MG)						REN_RG\mp1\RAIN (inches)	
	Time	Min.	Time	Max.	Average	Time	Min.	Time	Max.	Average	Time	Min.	Time	Max.	Average	Total	Total	
12/22/2017	1:25	0.9	12:40	4.2	1.5	11:05	0.3	12:40	2.7	0.9	1:25	0.006	12:40	0.428	0.046	0.046	0.10	
12/23/2017	23:45	0.7	11:35	3.6	1.0	23:50	0.0	11:35	2.4	0.4	23:50	0.000	11:35	0.308	0.012	0.012	0.00	
12/24/2017	17:40	0.7	0:55	3.3	0.9	18:15	0.0	0:55	2.3	0.3	18:15	0.000	0:55	0.266	0.011	0.011	0.00	
12/25/2017	6:25	0.7	15:45	3.8	1.2	6:25	0.0	15:45	2.5	0.5	6:25	0.000	15:45	0.356	0.022	0.022	0.14	
12/26/2017	7:10	0.9	20:30	3.6	1.3	4:45	0.2	20:30	2.4	0.7	4:45	0.005	20:30	0.303	0.026	0.026	0.17	
12/27/2017	4:55	0.7	11:45	3.5	1.1	4:55	0.0	11:45	2.4	0.5	4:55	0.000	11:45	0.293	0.017	0.017	0.00	
12/28/2017	7:45	1.2	20:55	4.3	1.6	1:00	0.4	20:55	2.8	1.0	1:00	0.013	20:55	0.468	0.048	0.048	0.25	
12/29/2017	23:20	1.8	11:05	9.4	4.1	23:20	1.1	10:45	3.5	2.5	23:20	0.054	11:05	1.429	0.436	0.436	1.57	
12/30/2017	8:15	0.9	19:20	4.2	1.6	8:05	0.3	19:20	2.7	1.0	8:05	0.006	19:20	0.435	0.059	0.059	0.02	
12/31/2017	23:30	1.0	6:10	3.7	1.3	22:20	0.3	16:30	2.5	0.6	22:30	0.006	6:10	0.336	0.023	0.023	0.00	
ReportAvg	1.6					0.8					0.070							
ReportTotal											0.700						2.25	

ADS Environmental Services

Pipe Height: 11.50

Date	REN_MH0166\mp1\DFINAL (inches)					REN_MH0166\mp1\VFINAL (feet/sec)					REN_MH0166\mp1\QFINAL (MGD - Total MG)					REN_RG\mp1\RAIN (inches)	
	Time	Min.	Time	Max.	Average	Time	Min.	Time	Max.	Average	Time	Min.	Time	Max.	Average	Total	Total
1/1/2018	13:05	0.9	5:20	3.5	1.2	11:15	0.3	5:20	2.4	0.5	11:15	0.006	5:20	0.294	0.018	0.018	0.00
1/2/2018	2:55	0.9	7:25	3.7	1.2	23:00	0.2	7:25	2.5	0.6	1:35	0.003	7:25	0.335	0.020	0.020	0.01
1/3/2018	5:20	0.8	13:25	2.6	1.2	5:20	0.2	17:00	1.9	0.6	5:20	0.002	13:25	0.155	0.022	0.022	0.00
1/4/2018	7:20	0.8	23:40	3.4	1.2	22:30	0.2	23:35	2.4	0.6	22:30	0.003	23:40	0.279	0.025	0.025	0.09
1/5/2018	23:15	1.1	10:40	5.1	2.2	23:15	0.2	10:40	3.0	1.5	23:15	0.006	10:40	0.628	0.118	0.118	0.42
1/6/2018	23:40	1.1	5:40	4.4	2.2	23:35	0.4	5:40	2.7	1.5	23:40	0.010	5:40	0.461	0.135	0.135	0.24
1/7/2018	6:40	1.0	21:25	2.3	1.5	3:55	0.3	19:05	1.9	0.9	6:40	0.007	19:05	0.128	0.044	0.044	0.38
1/8/2018	21:00	1.2	9:30	7.4	1.6	19:05	0.5	9:25	3.4	0.9	19:05	0.016	9:35	1.095	0.053	0.053	0.14
1/9/2018	12:05	1.5	15:10	6.6	2.2	8:10	0.8	15:40	3.2	1.6	8:10	0.031	15:10	0.919	0.125	0.125	0.46
1/10/2018	6:40	1.4	23:20	3.3	1.7	6:40	0.8	20:10	2.3	1.3	6:40	0.025	23:20	0.252	0.066	0.066	0.22
1/11/2018	0:45	2.0	15:00	13.6	5.9	15:45	0.5	12:15	3.3	2.4	5:25	0.068	18:05	1.179	0.600	0.600	1.04
1/12/2018	16:15	1.1	0:00	4.2	1.8	23:45	0.6	0:00	2.7	1.4	23:45	0.016	0:00	0.434	0.083	0.083	0.20
1/13/2018	2:45	1.0	17:05	15.6	1.6	17:05	0.3	17:35	3.2	0.8	2:45	0.008	17:25	1.177	0.054	0.054	0.02
1/14/2018	23:50	1.0	13:30	1.3	1.1	22:45	0.3	13:25	0.9	0.5	22:45	0.006	13:30	0.026	0.013	0.013	0.00
1/15/2018	22:55	1.0	13:15	1.8	1.1	0:40	0.2	13:15	1.3	0.5	0:40	0.005	13:15	0.065	0.014	0.014	0.04
1/16/2018	23:55	1.0	1:35	2.4	1.4	23:30	0.2	1:50	1.7	0.8	23:30	0.004	1:35	0.117	0.032	0.032	0.26
1/17/2018	2:50	0.9	18:25	7.0	2.4	7:50	0.4	11:10	3.3	1.5	7:35	0.008	18:20	0.979	0.196	0.196	0.79
1/18/2018	23:50	1.8	5:40	6.9	3.4	23:20	1.0	5:40	3.2	2.2	23:20	0.051	5:40	0.979	0.299	0.299	0.40
1/19/2018	21:05	1.4	15:40	2.7	1.7	21:00	0.7	15:40	2.2	1.2	21:00	0.023	15:40	0.189	0.059	0.059	0.10
1/20/2018	23:45	1.3	4:10	2.8	1.6	17:10	0.5	4:05	2.2	1.0	17:10	0.017	4:05	0.204	0.043	0.043	0.10
1/21/2018	16:15	1.3	17:05	7.2	1.6	11:40	0.6	17:00	3.2	1.0	11:40	0.018	17:15	0.978	0.061	0.061	0.16
1/22/2018	23:55	1.4	6:05	5.9	2.4	23:35	0.6	6:05	3.1	1.6	23:35	0.022	6:05	0.764	0.149	0.149	0.34
1/23/2018	4:00	1.3	16:15	6.9	3.2	9:00	0.7	16:00	3.4	1.9	1:15	0.022	16:10	1.022	0.295	0.295	0.79
1/24/2018	7:20	1.7	16:25	28.3	6.7	19:55	0.0	22:25	3.3	1.9	19:55	0.000	21:45	1.417	0.376	0.376	0.51
1/25/2018	6:15	1.3	10:50	5.0	2.2	6:15	0.7	10:50	2.9	1.5	6:15	0.020	10:50	0.594	0.119	0.119	0.14
1/26/2018	7:55	1.3	12:05	5.5	2.3	7:55	0.7	12:30	3.1	1.6	7:55	0.021	12:30	0.692	0.145	0.145	0.36
1/27/2018	23:55	1.2	1:35	7.0	3.2	21:05	0.4	2:30	3.4	2.0	21:05	0.011	1:40	1.027	0.290	0.290	0.61
1/28/2018	23:55	1.1	0:10	4.5	1.7	14:10	0.4	0:10	2.9	1.0	16:10	0.011	0:10	0.517	0.060	0.060	0.07
1/29/2018	1:45	1.1	16:05	7.5	3.9	4:10	0.3	14:35	3.5	2.0	4:10	0.007	14:35	1.141	0.441	0.441	0.90
1/30/2018	23:55	1.2	1:05	4.2	1.8	23:15	0.4	3:40	2.6	1.1	23:55	0.011	3:40	0.403	0.067	0.067	0.00
1/31/2018	3:55	1.0	5:00	3.6	1.4	4:45	0.3	15:25	2.5	0.7	4:45	0.006	15:25	0.315	0.030	0.030	0.00
ReportAvg	2.2					1.2					0.131						
ReportTotal																4.053	8.79

ADS Environmental Services

Pipe Height: 11.50

Date	REN_MH0166\mp1\DFINAL (inches)					REN_MH0166\mp1\VFINAL (feet/sec)					REN_MH0166\mp1\QFINAL (MGD - Total MG)						REN_RG\mp1\RAIN (inches)	
	Time	Min.	Time	Max.	Average	Time	Min.	Time	Max.	Average	Time	Min.	Time	Max.	Average	Total	Total	
2/1/2018	4:05	1.1	4:50	3.4	1.9	5:55	0.4	21:35	2.3	1.0	4:05	0.010	4:50	0.266	0.069	0.069	0.66	
2/2/2018	6:35	1.4	8:20	7.4	1.9	23:50	0.5	8:10	3.4	1.0	23:50	0.018	8:20	1.074	0.067	0.067	0.04	
2/3/2018	0:10	1.5	19:05	3.2	1.9	4:35	0.5	19:10	2.2	1.0	9:15	0.018	19:10	0.237	0.057	0.057	0.31	
2/4/2018	20:10	1.4	7:45	2.4	1.5	20:10	0.7	7:45	1.6	0.8	20:10	0.024	7:45	0.122	0.034	0.034	0.02	
2/5/2018	22:45	1.1	13:30	2.3	1.5	5:35	0.4	13:30	1.1	0.7	22:45	0.010	13:30	0.078	0.026	0.026	0.04	
2/6/2018	23:35	1.1	10:55	8.4	1.5	23:35	0.3	10:55	3.2	0.7	23:35	0.007	10:55	1.224	0.059	0.059	0.00	
2/7/2018	5:35	1.0	10:00	1.9	1.2	5:35	0.2	9:55	1.2	0.5	5:35	0.005	9:55	0.063	0.014	0.014	0.00	
2/8/2018	5:20	1.0	15:20	1.9	1.2	5:20	0.2	21:50	1.1	0.5	5:20	0.004	21:50	0.056	0.015	0.015	0.09	
2/9/2018	23:20	0.9	14:25	3.5	1.2	23:20	0.1	14:25	2.3	0.4	23:20	0.001	14:25	0.295	0.019	0.019	0.01	
2/10/2018	19:05	0.8	12:00	1.0	0.8	0:30	0.0	12:00	0.2	0.0	0:30	0.000	12:00	0.004	0.001	0.001	0.01	
2/11/2018	16:10	0.8	12:20	1.5	0.8	0:00	0.0	12:25	0.6	0.0	0:00	0.000	12:20	0.022	0.001	0.001	0.00	
2/12/2018	2:20	0.8	16:30	1.4	1.0	0:00	0.0	16:25	0.7	0.2	0:00	0.000	16:25	0.025	0.007	0.007	0.00	
2/13/2018	2:05	0.8	23:55	2.2	1.1	1:20	0.0	23:55	1.7	0.3	1:20	0.000	23:55	0.107	0.011	0.011	0.17	
2/14/2018	23:55	1.0	1:15	2.5	1.5	6:10	0.2	0:05	1.7	0.7	8:45	0.005	1:15	0.127	0.031	0.031	0.15	
2/15/2018	6:55	0.8	10:30	6.7	1.4	6:55	0.0	10:30	3.2	0.4	6:55	0.001	10:30	0.941	0.036	0.036	0.00	
2/16/2018	3:30	1.0	3:40	2.4	1.4	3:30	0.2	3:40	1.4	0.5	3:30	0.005	3:40	0.106	0.020	0.020	0.15	
2/17/2018	4:35	1.0	9:30	3.3	1.6	4:35	0.2	6:15	1.9	0.7	4:35	0.004	9:30	0.218	0.041	0.041	0.32	
2/18/2018	23:50	1.0	16:15	1.2	1.1	18:50	0.2	16:05	0.5	0.3	23:50	0.003	16:05	0.013	0.007	0.007	0.01	
2/19/2018	3:00	0.9	10:15	7.5	1.3	23:55	0.0	10:25	3.2	0.5	23:55	0.000	10:15	1.083	0.033	0.033	0.00	
2/20/2018	6:40	1.0	15:50	4.5	1.4	6:40	0.2	15:50	2.5	0.4	6:40	0.003	15:50	0.435	0.017	0.017	0.00	
2/21/2018	5:35	0.9	16:10	1.7	1.3	5:35	0.1	16:10	0.6	0.4	5:35	0.003	16:10	0.028	0.012	0.012	0.00	
2/22/2018	4:25	1.0	9:30	1.9	1.3	4:25	0.2	9:30	0.7	0.4	4:25	0.004	9:30	0.038	0.012	0.012	0.07	
2/23/2018	7:25	0.8	11:30	6.8	1.5	5:55	0.0	11:30	3.2	0.5	5:55	0.000	11:30	0.974	0.040	0.040	0.01	
2/24/2018	2:10	1.5	10:20	2.8	1.6	0:30	0.4	10:35	1.2	0.5	0:30	0.015	10:25	0.106	0.023	0.023	0.13	
2/25/2018	1:05	1.5	5:50	4.0	1.9	23:55	0.4	5:50	2.2	0.7	23:55	0.016	5:50	0.323	0.049	0.049	0.11	
2/26/2018	22:05	1.5	9:00	2.3	1.7	7:05	0.3	15:30	0.8	0.5	7:05	0.012	9:00	0.053	0.024	0.024	0.00	
2/27/2018	4:30	1.5	16:10	2.1	1.7	23:55	0.4	16:10	0.8	0.5	23:55	0.014	16:10	0.048	0.025	0.025	0.19	
2/28/2018	3:45	1.4	22:25	4.3	1.8	3:55	0.2	22:25	2.4	0.6	3:55	0.008	22:25	0.404	0.039	0.039	0.35	
ReportAvg	1.4					0.5					0.028							
ReportTotal																	0.786	2.84

ADS Environmental Services

Pipe Height: 11.50

Date	REN_MH0166\mp1\DFINAL (inches)					REN_MH0166\mp1\VFINAL (feet/sec)					REN_MH0166\mp1\QFINAL (MGD - Total MG)						REN_RG\mp1\RAIN (inches)	
	Time	Min.	Time	Max.	Average	Time	Min.	Time	Max.	Average	Time	Min.	Time	Max.	Average	Total	Total	
3/1/2018	23:55	1.1	16:20	7.5	1.5	8:00	0.2	16:25	3.2	0.5	23:55	0.006	16:20	1.078	0.031	0.031	0.01	
3/2/2018	3:25	1.0	5:30	2.6	1.5	3:25	0.2	4:50	1.2	0.4	3:25	0.003	4:50	0.101	0.020	0.020	0.07	
3/3/2018	23:55	1.0	18:50	1.6	1.2	17:15	0.2	15:30	0.5	0.3	23:55	0.004	18:50	0.020	0.007	0.007	0.00	
3/4/2018	15:55	1.0	16:45	2.9	1.1	15:55	0.2	16:45	1.3	0.3	15:55	0.003	16:45	0.130	0.009	0.009	0.12	
3/5/2018	6:55	1.0	15:00	7.6	1.5	6:55	0.2	15:10	3.2	0.4	6:55	0.003	15:00	1.089	0.036	0.036	0.00	
3/6/2018	7:25	0.9	18:20	2.8	1.3	6:25	0.1	18:20	1.5	0.3	7:25	0.002	18:20	0.141	0.011	0.011	0.00	
3/7/2018	7:00	1.1	10:00	7.5	1.5	7:00	0.2	10:05	3.2	0.5	7:00	0.005	10:00	1.083	0.030	0.030	0.03	
3/8/2018	7:25	0.9	11:05	6.5	1.7	9:05	0.1	11:05	3.1	0.7	7:25	0.003	11:05	0.884	0.053	0.053	0.37	
3/9/2018	23:55	1.0	10:00	7.4	1.6	23:55	0.2	9:55	3.2	0.5	23:55	0.003	10:00	1.061	0.043	0.043	0.00	
3/10/2018	21:05	0.8	3:10	3.6	1.2	19:15	0.0	3:05	2.1	0.3	19:15	0.000	3:10	0.272	0.012	0.012	0.00	
3/11/2018	17:30	0.8	22:15	1.0	0.8	0:00	0.0	22:15	0.2	0.0	0:00	0.000	22:15	0.003	0.000	0.000	0.00	
3/12/2018	4:45	0.8	17:35	7.2	1.3	0:00	0.0	17:40	3.2	0.4	0:00	0.000	17:35	1.032	0.029	0.029	0.00	
3/13/2018	5:55	0.8	13:40	6.3	1.5	2:20	0.0	17:25	3.0	0.5	2:20	0.000	13:40	0.797	0.035	0.035	0.31	
3/14/2018	6:15	0.9	13:45	7.4	1.4	4:40	0.1	13:45	3.2	0.4	6:15	0.002	13:45	1.071	0.027	0.027	0.04	
3/15/2018	0:35	0.9	9:35	3.6	1.5	0:25	0.1	9:35	2.0	0.4	0:35	0.002	9:35	0.257	0.020	0.020	0.00	
3/16/2018	4:30	0.8	6:55	3.4	1.2	0:05	0.0	6:55	1.9	0.3	0:05	0.000	6:55	0.236	0.010	0.010	0.00	
3/17/2018	23:30	0.8	13:25	1.3	1.0	4:10	0.0	13:25	0.3	0.1	4:10	0.000	13:25	0.010	0.003	0.003	0.00	
3/18/2018	3:00	0.8	14:05	1.8	1.1	0:00	0.0	13:50	0.6	0.2	0:00	0.000	13:50	0.025	0.007	0.007	0.00	
3/19/2018	23:55	1.1	14:55	7.3	1.5	13:35	0.2	14:50	3.2	0.4	23:55	0.005	14:55	1.057	0.032	0.032	0.00	
3/20/2018	23:55	0.8	17:30	6.0	1.2	23:10	0.0	17:30	2.8	0.4	23:10	0.000	17:30	0.730	0.018	0.018	0.00	
3/21/2018	3:50	0.7	10:45	5.1	1.1	0:00	0.0	10:45	2.8	0.3	0:00	0.000	10:45	0.588	0.012	0.012	0.10	
3/22/2018	6:05	0.7	12:00	6.9	1.6	0:00	0.0	12:05	3.3	0.5	0:00	0.000	12:00	0.987	0.057	0.057	0.48	
3/23/2018	5:25	0.8	8:45	6.5	1.9	0:00	0.0	8:45	3.1	0.7	0:00	0.000	8:45	0.888	0.098	0.098	0.31	
3/24/2018	23:55	0.8	5:15	2.4	1.3	15:40	0.0	5:25	1.6	0.4	15:40	0.000	5:25	0.119	0.018	0.018	0.28	
3/25/2018	7:50	0.8	10:20	1.7	1.0	0:00	0.0	10:20	0.9	0.1	0:00	0.000	10:20	0.037	0.003	0.003	0.01	
3/26/2018	2:35	0.8	9:10	6.4	1.5	0:00	0.0	9:05	3.2	0.6	0:00	0.000	9:05	0.867	0.059	0.059	0.17	
3/27/2018	5:10	1.0	7:15	6.1	1.5	4:35	0.0	7:15	3.1	0.6	4:35	0.000	7:15	0.792	0.036	0.036	0.02	
3/28/2018	23:55	0.8	10:15	4.1	1.3	5:25	0.0	10:10	2.5	0.4	5:25	0.000	10:15	0.396	0.021	0.021	0.01	
3/29/2018	5:15	0.7	10:25	9.9	2.1	0:00	0.0	9:30	3.3	0.8	0:00	0.000	10:30	1.311	0.167	0.167	0.00	
3/30/2018	5:25	0.7	11:40	6.0	1.2	0:00	0.0	11:40	3.0	0.3	0:00	0.000	11:40	0.773	0.023	0.023	0.00	
3/31/2018	5:10	0.9	12:25	1.1	1.0	0:35	0.0	12:25	0.2	0.0	0:35	0.000	12:25	0.004	0.001	0.001	0.00	
ReportAvg	1.4					0.4					0.030							
ReportTotal																	0.929	2.33

ADS Environmental Services

Pipe Height: 11.50

Date	REN_MH0166\mp1\DFINAL (inches)					REN_MH0166\mp1\VFINAL (feet/sec)					REN_MH0166\mp1\QFINAL (MGD - Total MG)					REN_RG\mp1\RAIN (inches)	
	Time	Min.	Time	Max.	Average	Time	Min.	Time	Max.	Average	Time	Min.	Time	Max.	Average	Total	Total
4/1/2018	22:35	0.9	23:30	1.1	0.9	0:00	0.0	23:30	0.2	0.0	0:00	0.000	23:30	0.004	0.000	0.000	0.10
4/2/2018	1:20	1.0	10:10	6.1	1.7	0:25	0.0	10:05	3.1	0.7	0:25	0.000	10:05	0.798	0.050	0.050	0.00
4/3/2018	23:55	1.1	14:00	6.2	1.6	23:55	0.1	14:00	3.2	0.7	23:55	0.003	14:00	0.845	0.047	0.047	0.00
4/4/2018	1:20	1.0	14:00	6.6	1.7	0:20	0.0	14:00	3.2	0.7	0:20	0.000	14:00	0.922	0.053	0.053	0.39
4/5/2018	6:35	1.1	10:45	6.7	1.7	6:35	0.2	10:45	3.2	0.7	6:35	0.004	10:45	0.949	0.051	0.051	0.25
4/6/2018	22:30	1.0	10:30	6.4	1.6	21:40	0.0	10:30	3.1	0.6	21:40	0.000	10:30	0.858	0.051	0.051	0.00
4/7/2018	1:20	1.1	3:10	6.3	2.2	1:20	0.1	3:10	3.1	1.1	1:20	0.003	3:10	0.847	0.102	0.102	0.88
4/8/2018	23:55	1.2	8:35	2.6	1.8	23:55	0.3	8:35	1.5	0.9	23:55	0.009	8:35	0.125	0.049	0.049	0.45
4/9/2018	23:55	1.0	9:50	6.4	1.7	23:55	0.1	9:35	3.3	0.7	23:55	0.002	9:35	0.899	0.053	0.053	0.00
4/10/2018	1:20	1.0	9:10	6.3	1.6	0:10	0.0	9:10	3.3	0.7	0:10	0.000	9:10	0.913	0.059	0.059	0.23
4/11/2018	1:00	0.9	8:30	5.0	1.6	0:45	0.0	8:30	2.9	0.8	0:45	0.000	8:30	0.602	0.049	0.049	0.31
4/12/2018	23:55	0.9	15:05	6.3	1.6	22:55	0.0	15:25	3.2	0.7	22:55	0.000	15:05	0.866	0.056	0.056	0.11
4/13/2018	1:20	0.9	16:10	6.4	2.2	0:00	0.0	16:10	3.2	1.3	0:00	0.000	16:10	0.871	0.114	0.114	0.51
4/14/2018	12:25	1.6	23:45	13.8	5.0	12:25	0.6	15:35	3.4	2.1	12:25	0.026	20:15	1.287	0.432	0.432	1.52
4/15/2018	23:55	1.7	0:05	13.4	5.4	23:30	0.8	4:05	3.3	2.2	23:45	0.037	3:05	1.314	0.465	0.465	0.21
4/16/2018	6:40	1.7	13:50	6.3	2.6	23:15	0.6	14:25	3.3	1.6	0:10	0.030	13:40	0.889	0.161	0.161	0.71
4/17/2018	23:55	1.3	7:05	6.5	2.1	21:55	0.2	7:05	3.4	1.0	21:55	0.008	7:05	0.953	0.082	0.082	0.01
4/18/2018	0:10	1.3	14:45	3.4	1.8	22:15	0.2	9:20	2.3	0.7	23:20	0.006	9:20	0.273	0.047	0.047	0.12
4/19/2018	23:55	1.2	14:05	6.1	1.7	20:50	0.2	14:05	3.0	0.7	20:50	0.006	14:05	0.773	0.042	0.042	0.00
4/20/2018	22:35	1.1	1:00	3.6	1.7	22:35	0.2	1:00	2.3	0.7	22:35	0.004	1:00	0.300	0.041	0.041	0.00
4/21/2018	23:55	1.1	13:05	3.5	1.7	23:15	0.2	13:05	2.3	0.7	23:55	0.005	13:05	0.293	0.040	0.040	0.05
4/22/2018	5:00	1.0	21:30	3.2	1.5	2:10	0.0	13:10	2.1	0.5	2:10	0.000	21:30	0.225	0.025	0.025	0.00
ReportAvg	2.1					0.9					0.094						
ReportTotal																2.071	5.85

REN_MH0286

Located At: 3000 SE 5th St (see attached site report for details)
Monitoring Period: December 22, 2017 – April 22, 2018
Pipe Dimensions: 9.88"
Finalized Silt Level: 0 mm

Site Data Characteristics: This site is located in a sanitary sewer pipe. The scattergraph indicates site operated in free flow conditions. The site did not surcharge during the monitoring period. The dry weather data plots below the Froude =1 curve indicating subcritical flow.

Site Data Bias & Editing: The depth and velocity measurements recorded by the flow monitor were consistent with field confirmations conducted to date and supported the relative accuracy of the flow monitor at this location. The finalized depth data utilized both the pressure sensor and upward ultrasonic sensor.

Site Data Uptime: The data uptime achieved during the monitoring period is provided in the table below. Based upon the quality and consistency of the observed flow depth and velocity data, the Continuity equation was used to calculate the flow rate for the monitoring period.

Entity	Percentage Uptime	
	Raw	Final
Depth (in)	100%	100%
Velocity (f/s)	100%	100%
Quantity (mgd)	100%	100%

Site Data Summary: The average flow depth, velocity, and quantity data observed during the monitoring period along with observed minimum and maximum data, are provided in the following table. The minimum and maximum rates recorded in the tables are based on 5-minute data intervals.

Item	Depth (in)	Velocity (f/s)	Quantity (mgd)	% Full
Minimum	2.72	0.36	0.028	28%
Maximum	5.93	1.06	0.212	60%
Average	3.40	0.66	0.072	34%

Renton.Carollo.I&I.WA17

Flow Monitoring Site Report



Site Name

REN_MH1763

Site Address /Location:	3000 SE 5th St		
Site Access Details:	Located in roadway, at intersection. Requires traffic control.	Latitude:	47.477311°
		Longitude:	-122.179048°

Monitor Series	Location Type
TRITON+	Temporary
Pipe Size (H x W)	Pipe Shape
15.00" x 15.00"	Circular

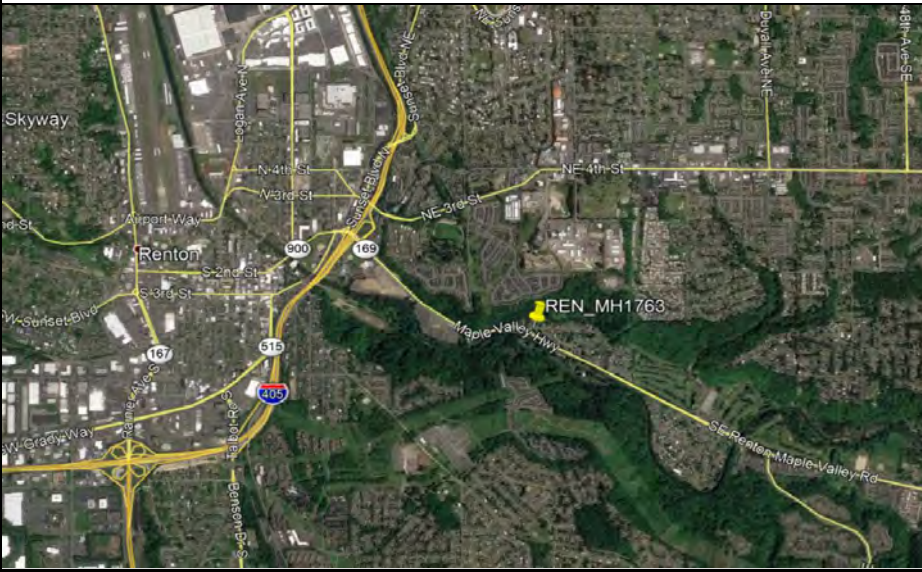

Manhole #	System Characteristics
MH1763	Residential
Access	Traffic
Drive	Medium



Installation Information

Installation Date:	Installation Type:
12.13.17	Doppler Standard Ring and Crank
Monitoring Location (Sensors):	Monitor Location:
Upstream 0-5 FT	Manhole
Sensors / Devices:	Pressure Sensor Range (psi)
Peak Combo (CS4), Smart Depth (CS5)	0 - 5 psi

Installation Confirmation:

Confirmation Time:	Pipe Size (HxW)
3:17:00 PM	15.00" x 15.00"
Depth of Flow (Wet DOF) (in)	Range (Air DOF) (in)
~8.00"	
Downlooker Physical Offset (in)	Measurement Confidence (in)
1.25"	0.25"
Peak Velocity (fps)	Velocity Sensor Offset (in)
.3 FPS	
Silt (in)	Silt Type
0	

Hydraulic Comments:
Moderate, slow flow

Manhole / Pipe Information:

Manhole Depth (Approx. FT):	Manhole Configuration
~8'	Single
Manhole Material:	Manhole Condition:
Concrete	Good
Manhole Opening Diameter (in)	Manhole Diameter (Approx.):
20"	20"
Manhole Cover	Manhole Frame
Unbolted	Normal
Active Drop Connections	Air Quality:
No	Normal
Pipe Material	Pipe Condition:
Concrete	Good

Communication Information:

Communication Type	Antenna Location
Wireless	Manhole Pick / Vent Hole

Additional Site Info. / Comments:

Site located in roadway. Traffic control required.

ADS Project Name:	Renton.Carollo.I&I.WA17
ADS Project Number:	22275.11.325

Additional Photos

Upstream



Downstream



Side Inlet



Top Down



Location



Location

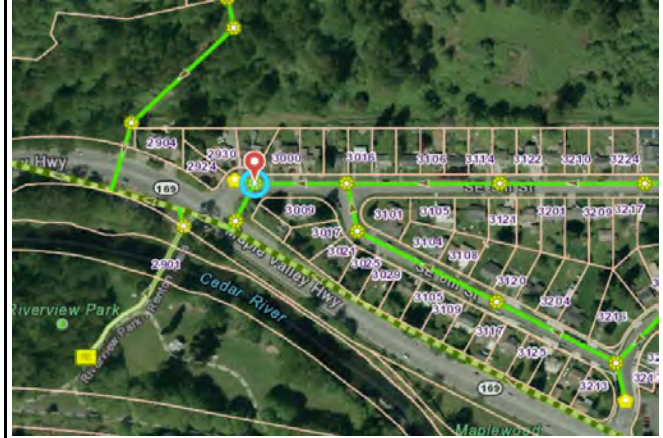

→ Flow Direction

⊖ Monitoring Point

HYDROGRAPH REPORT

REN_MH0286

Flow Monitor
REN_MH0286

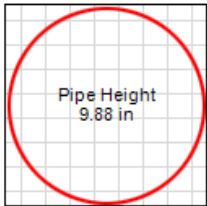

Report Period
12/22/2017
To
4/22/2018

Legend
— Depth
— Velocity
— Rain

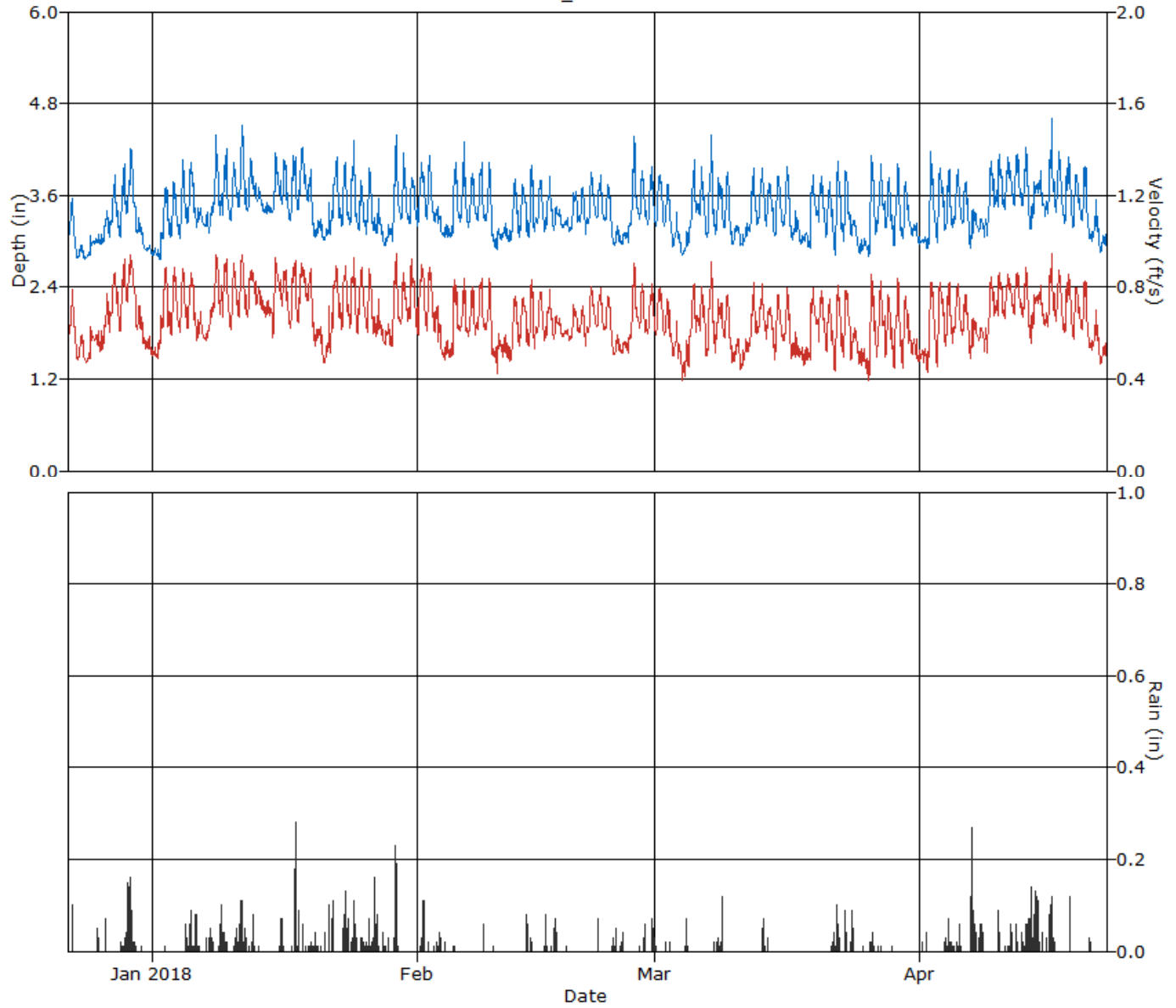

HYDROGRAPH REPORT

REN_MH0286

Flow Monitor
REN_MH0286

Pipe Height
9.88 in.

Report Period
12/22/2017
To
4/22/2018

Legend
— Quantity
— Rain

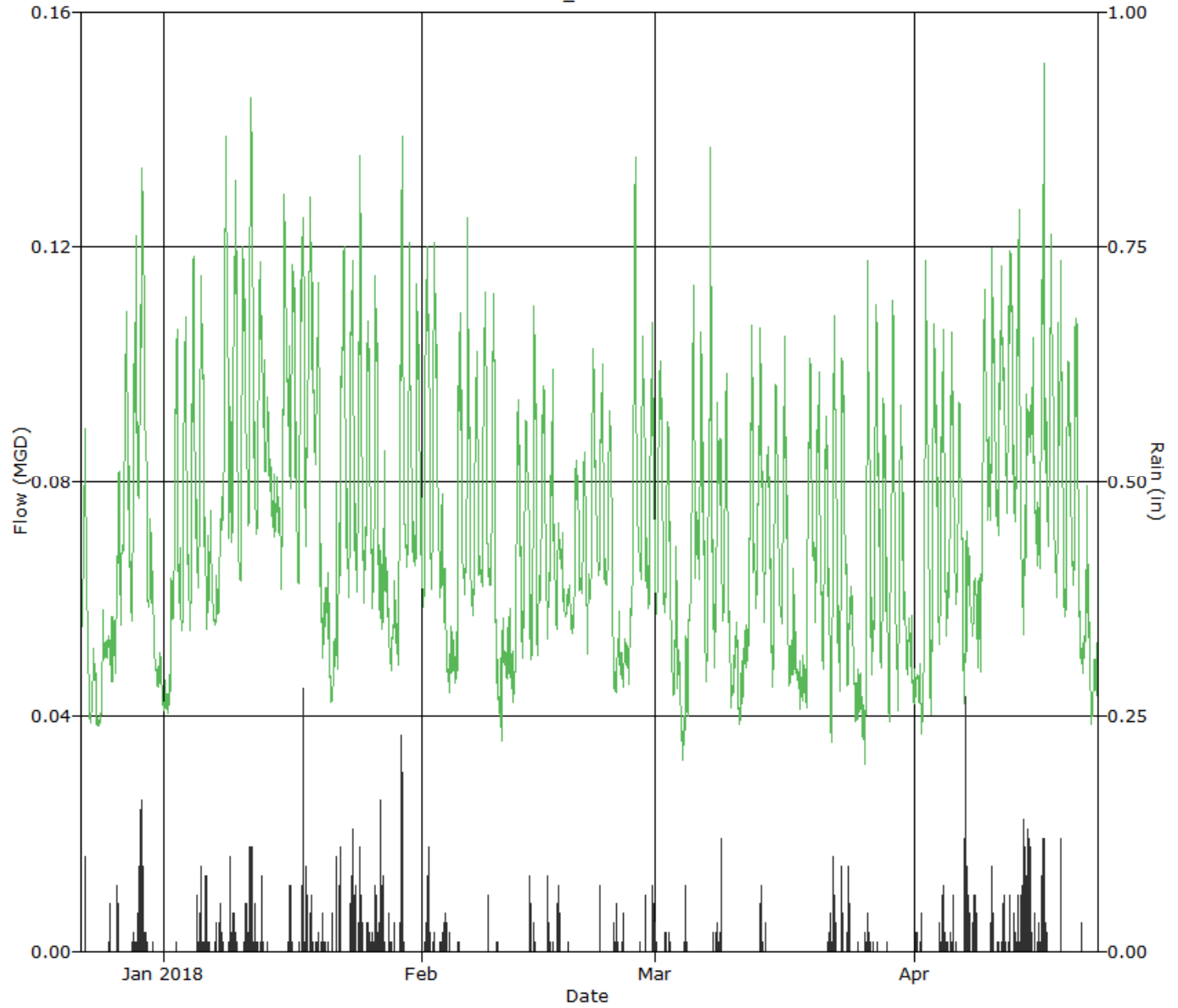

SCATTERGRAPH REPORT

REN_MH0286

Flow Monitor
REN_MH0286

Pipe Height
9.88 in

Report Period
12/22/2017
To
4/22/2018

Legend
○ Depth - Velocity
--- Iso-Q™
--- Silt
▼ Min-Max Depth

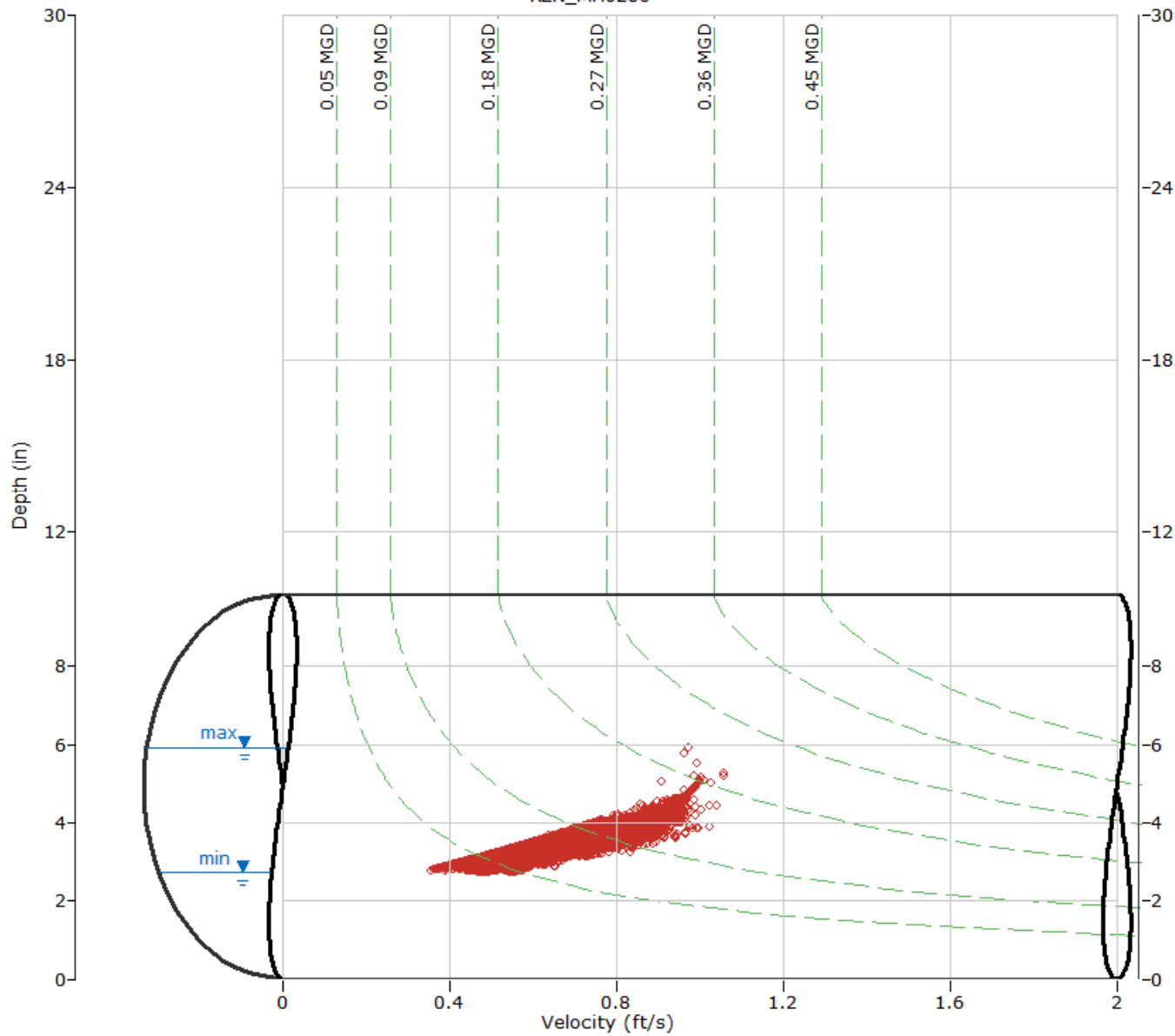

ADS Environmental Services

Pipe Height: 9.88

Date	REN_MH0286\mp1\DFINAL (inches)					REN_MH0286\mp1\VFINAL (feet/sec)					REN_MH0286\mp1\QFINAL (MGD - Total MG)						REN_RG\mp1\RAIN (inches)	
	Time	Min.	Time	Max.	Average	Time	Min.	Time	Max.	Average	Time	Min.	Time	Max.	Average	Total	Total	
12/22/2017	23:55	2.9	12:40	3.7	3.2	23:55	0.5	13:45	0.8	0.7	23:55	0.044	13:45	0.095	0.065	0.065	0.10	
12/23/2017	6:40	2.7	15:15	3.1	2.8	8:10	0.5	20:05	0.7	0.5	6:30	0.037	15:15	0.060	0.044	0.044	0.00	
12/24/2017	0:50	2.7	16:45	3.3	2.9	3:35	0.4	18:00	0.7	0.5	3:35	0.036	16:55	0.072	0.044	0.044	0.00	
12/25/2017	16:40	2.9	17:05	3.2	3.0	22:30	0.5	23:20	0.7	0.6	22:30	0.043	23:15	0.069	0.051	0.051	0.14	
12/26/2017	5:05	2.9	9:15	3.8	3.2	5:00	0.5	15:55	0.8	0.6	5:00	0.044	9:15	0.097	0.062	0.062	0.17	
12/27/2017	21:50	3.1	13:30	4.4	3.4	22:10	0.6	13:35	0.9	0.8	21:50	0.061	13:30	0.133	0.082	0.082	0.00	
12/28/2017	4:20	3.0	16:50	4.1	3.5	3:40	0.6	15:40	1.0	0.8	3:40	0.054	16:45	0.131	0.083	0.083	0.25	
12/29/2017	22:00	3.3	10:00	4.4	3.7	23:50	0.6	9:10	1.0	0.8	23:50	0.067	10:00	0.142	0.101	0.101	1.57	
12/30/2017	23:50	2.9	8:05	3.4	3.1	12:00	0.5	8:20	0.8	0.6	23:50	0.045	8:20	0.084	0.060	0.060	0.02	
12/31/2017	22:30	2.8	14:10	3.1	2.9	23:00	0.5	14:15	0.6	0.5	22:30	0.039	14:10	0.059	0.046	0.046	0.00	
ReportAvg	3.2					0.6					0.064							
ReportTotal																	0.638	2.25

ADS Environmental Services

Pipe Height: 9.88

Date	REN_MH0286\mp1\DFINAL (inches)					REN_MH0286\mp1\VFINAL (feet/sec)					REN_MH0286\mp1\QFINAL (MGD - Total MG)						REN_RG\mp1\RAIN (inches)	
	Time	Min.	Time	Max.	Average	Time	Min.	Time	Max.	Average	Time	Min.	Time	Max.	Average	Total	Total	
1/1/2018	21:20	2.7	22:55	3.5	2.9	12:15	0.5	22:55	0.8	0.5	12:15	0.037	22:55	0.090	0.045	0.045	0.00	
1/2/2018	0:05	3.0	11:50	4.0	3.3	0:05	0.6	15:55	0.9	0.7	0:05	0.052	11:50	0.116	0.074	0.074	0.01	
1/3/2018	4:55	3.0	15:05	4.2	3.4	4:50	0.6	15:10	0.9	0.7	4:50	0.050	15:10	0.133	0.076	0.076	0.00	
1/4/2018	5:30	3.0	14:25	4.5	3.5	0:00	0.5	14:20	1.0	0.7	4:55	0.051	14:25	0.150	0.081	0.081	0.09	
1/5/2018	2:45	3.2	12:35	4.2	3.6	4:50	0.6	13:30	1.0	0.7	4:50	0.059	13:30	0.132	0.085	0.085	0.42	
1/6/2018	3:35	3.2	7:25	3.5	3.3	10:00	0.5	15:40	0.7	0.6	23:40	0.053	16:20	0.079	0.064	0.064	0.24	
1/7/2018	13:45	3.1	9:05	3.5	3.3	5:40	0.5	18:45	0.8	0.6	5:40	0.052	18:45	0.080	0.062	0.062	0.38	
1/8/2018	21:40	3.3	10:50	5.3	3.7	0:50	0.7	10:45	1.1	0.8	0:50	0.067	10:50	0.200	0.095	0.095	0.14	
1/9/2018	5:10	3.3	16:00	4.6	3.7	6:05	0.7	16:05	1.0	0.8	5:20	0.068	16:00	0.153	0.095	0.095	0.46	
1/10/2018	3:40	3.2	9:05	4.5	3.6	5:20	0.6	13:05	1.0	0.8	5:20	0.057	14:25	0.136	0.089	0.089	0.22	
1/11/2018	5:25	3.4	11:15	4.8	3.9	4:40	0.6	11:15	1.0	0.8	4:40	0.069	11:15	0.164	0.102	0.102	1.04	
1/12/2018	4:45	3.3	12:55	4.2	3.7	4:45	0.7	10:20	0.9	0.8	4:45	0.068	15:20	0.130	0.095	0.095	0.20	
1/13/2018	23:55	3.4	12:20	4.2	3.6	14:20	0.7	2:25	0.9	0.8	23:55	0.073	2:25	0.126	0.085	0.085	0.02	
1/14/2018	23:20	3.3	8:00	3.8	3.4	5:25	0.7	8:00	0.8	0.7	5:25	0.069	8:00	0.102	0.074	0.074	0.00	
1/15/2018	0:35	3.4	10:45	4.6	3.7	4:00	0.6	11:30	1.0	0.8	3:05	0.061	10:45	0.156	0.094	0.094	0.04	
1/16/2018	23:05	3.4	10:00	4.3	3.7	20:00	0.6	1:05	0.9	0.8	19:55	0.067	10:00	0.131	0.096	0.096	0.26	
1/17/2018	3:00	3.2	19:40	4.3	3.7	4:50	0.6	19:10	1.0	0.8	4:55	0.061	19:40	0.137	0.094	0.094	0.79	
1/18/2018	2:25	3.4	13:15	4.4	3.8	2:00	0.6	13:15	0.9	0.8	2:00	0.065	13:15	0.142	0.101	0.101	0.40	
1/19/2018	23:55	3.1	13:50	4.3	3.6	23:55	0.6	5:25	0.9	0.8	23:55	0.054	13:50	0.133	0.087	0.087	0.10	
1/20/2018	2:20	3.0	19:35	3.5	3.2	6:25	0.5	19:35	0.7	0.6	6:25	0.044	19:35	0.082	0.056	0.056	0.10	
1/21/2018	4:25	3.0	17:40	3.6	3.1	3:55	0.4	17:20	0.8	0.5	3:55	0.040	17:25	0.088	0.051	0.051	0.16	
1/22/2018	5:10	3.2	15:25	4.2	3.6	4:15	0.6	15:10	1.0	0.8	4:15	0.059	15:15	0.132	0.089	0.089	0.34	
1/23/2018	22:30	3.2	15:50	4.2	3.6	7:25	0.6	15:50	0.9	0.8	5:40	0.059	15:50	0.127	0.086	0.086	0.79	
1/24/2018	6:00	3.2	14:45	4.5	3.6	6:10	0.6	14:10	1.0	0.7	6:10	0.059	14:45	0.146	0.087	0.087	0.51	
1/25/2018	5:50	3.1	10:55	4.0	3.4	2:05	0.6	11:05	1.0	0.8	1:20	0.057	11:05	0.124	0.081	0.081	0.14	
1/26/2018	1:30	3.1	9:10	4.6	3.4	1:20	0.6	9:10	1.0	0.7	1:20	0.053	9:10	0.156	0.078	0.078	0.36	
1/27/2018	10:10	3.1	11:20	3.8	3.2	14:55	0.5	11:25	0.8	0.6	10:10	0.051	11:25	0.102	0.062	0.062	0.61	
1/28/2018	6:15	2.9	20:35	3.4	3.0	23:55	0.5	17:15	0.7	0.6	7:25	0.046	20:35	0.072	0.053	0.053	0.07	
1/29/2018	3:50	3.0	15:10	4.6	3.6	0:00	0.5	14:55	1.0	0.7	0:00	0.046	15:10	0.148	0.087	0.087	0.90	
1/30/2018	2:45	3.3	12:30	4.6	3.5	22:05	0.5	12:30	1.0	0.7	21:25	0.056	12:30	0.152	0.082	0.082	0.00	
1/31/2018	2:55	3.2	16:55	4.0	3.5	23:30	0.6	9:55	1.0	0.7	23:30	0.058	9:55	0.130	0.083	0.083	0.00	
ReportAvg	3.5					0.7					0.080							
ReportTotal																	2.490	8.79

ADS Environmental Services

Pipe Height: 9.88

Date	REN_MH0286\mp1\DFINAL (inches)					REN_MH0286\mp1\VFINAL (feet/sec)					REN_MH0286\mp1\QFINAL (MGD - Total MG)						REN_RG\mp1\RAIN (inches)	
	Time	Min.	Time	Max.	Average	Time	Min.	Time	Max.	Average	Time	Min.	Time	Max.	Average	Total	Total	
2/1/2018	3:05	3.2	14:00	4.5	3.6	5:30	0.5	13:55	1.0	0.8	5:30	0.052	13:55	0.157	0.090	0.090	0.66	
2/2/2018	4:55	3.3	13:45	4.3	3.6	4:20	0.6	11:35	0.9	0.7	4:55	0.060	13:45	0.133	0.088	0.088	0.04	
2/3/2018	23:05	3.1	11:50	3.8	3.3	23:30	0.5	11:50	0.8	0.6	23:30	0.046	11:50	0.100	0.064	0.064	0.31	
2/4/2018	6:10	3.0	12:25	3.4	3.1	6:10	0.5	15:45	0.6	0.5	6:10	0.043	12:25	0.061	0.049	0.049	0.02	
2/5/2018	0:15	3.0	15:30	4.4	3.5	1:00	0.5	15:30	0.9	0.7	1:00	0.043	15:30	0.136	0.077	0.077	0.04	
2/6/2018	3:10	3.2	12:25	5.8	3.5	2:00	0.5	12:30	1.0	0.7	2:00	0.052	12:25	0.204	0.075	0.075	0.00	
2/7/2018	2:45	3.2	8:15	4.0	3.5	1:30	0.5	8:15	0.8	0.7	1:30	0.050	8:15	0.111	0.075	0.075	0.00	
2/8/2018	5:40	3.2	15:25	4.2	3.6	19:30	0.6	15:25	0.9	0.7	5:40	0.059	15:25	0.127	0.081	0.081	0.09	
2/9/2018	23:10	3.0	13:30	4.1	3.5	23:00	0.4	13:30	0.9	0.7	23:00	0.039	13:30	0.119	0.074	0.074	0.01	
2/10/2018	7:45	2.9	1:25	3.3	3.0	7:10	0.4	17:35	0.7	0.5	11:45	0.034	17:35	0.065	0.047	0.047	0.01	
2/11/2018	16:15	2.9	12:10	3.5	3.1	21:20	0.4	12:10	0.7	0.5	21:30	0.038	12:10	0.074	0.050	0.050	0.00	
2/12/2018	2:55	3.0	12:10	4.1	3.4	0:25	0.4	12:10	0.9	0.6	0:25	0.041	12:10	0.119	0.068	0.068	0.00	
2/13/2018	2:30	3.0	11:15	3.9	3.4	2:30	0.5	11:15	0.8	0.7	2:30	0.047	11:15	0.101	0.071	0.071	0.17	
2/14/2018	21:35	3.0	10:15	4.2	3.4	21:25	0.5	10:15	0.9	0.7	21:25	0.042	10:15	0.123	0.071	0.071	0.15	
2/15/2018	23:55	3.2	13:25	4.1	3.5	22:45	0.6	13:25	0.9	0.7	23:55	0.056	13:25	0.119	0.075	0.075	0.00	
2/16/2018	0:20	3.1	15:15	4.0	3.4	6:15	0.5	15:15	0.8	0.7	0:20	0.052	15:15	0.109	0.071	0.071	0.15	
2/17/2018	4:05	3.1	8:10	3.5	3.3	4:05	0.6	8:10	0.7	0.6	4:05	0.053	8:10	0.077	0.065	0.065	0.32	
2/18/2018	23:20	3.1	17:25	3.7	3.2	17:30	0.5	10:45	0.7	0.6	23:20	0.051	17:25	0.075	0.059	0.059	0.01	
2/19/2018	3:15	3.1	11:30	3.8	3.4	20:40	0.6	11:30	0.8	0.6	3:15	0.053	11:30	0.094	0.068	0.068	0.00	
2/20/2018	21:55	3.0	14:45	3.8	3.4	21:05	0.5	10:00	0.8	0.6	21:05	0.047	10:00	0.096	0.067	0.067	0.00	
2/21/2018	2:35	3.2	13:45	4.1	3.5	7:40	0.6	13:45	0.9	0.7	2:35	0.058	13:45	0.120	0.079	0.079	0.00	
2/22/2018	23:15	3.2	14:25	4.0	3.5	22:05	0.6	14:25	0.8	0.7	22:05	0.059	14:25	0.108	0.076	0.076	0.07	
2/23/2018	22:30	3.1	11:35	3.9	3.4	22:30	0.5	11:35	0.8	0.7	22:30	0.050	11:35	0.103	0.073	0.073	0.01	
2/24/2018	23:40	2.9	15:25	3.3	3.0	21:20	0.5	15:25	0.6	0.5	23:40	0.042	15:25	0.062	0.049	0.049	0.13	
2/25/2018	0:15	2.9	12:45	3.3	3.1	20:45	0.4	12:45	0.6	0.5	20:45	0.039	12:45	0.061	0.050	0.050	0.11	
2/26/2018	3:30	3.2	14:35	5.1	3.6	3:35	0.5	14:35	1.0	0.7	3:35	0.048	14:35	0.179	0.084	0.084	0.00	
2/27/2018	22:25	3.3	11:05	4.0	3.6	21:35	0.5	11:05	0.8	0.7	21:35	0.055	11:05	0.110	0.079	0.079	0.19	
2/28/2018	5:00	3.2	13:15	4.1	3.5	0:55	0.5	13:15	0.9	0.7	0:55	0.053	13:15	0.118	0.078	0.078	0.35	
ReportAvg	3.4					0.6					0.070							
ReportTotal																	1.951	2.84

ADS Environmental Services

Pipe Height: 9.88

Date	REN_MH0286\mp1\DFINAL (inches)					REN_MH0286\mp1\VFINAL (feet/sec)					REN_MH0286\mp1\QFINAL (MGD - Total MG)						REN_RG\mp1\RAIN (inches)		
	Time	Min.	Time	Max.	Average	Time	Min.	Time	Max.	Average	Time	Min.	Time	Max.	Average	Total	Total		
3/1/2018	5:10	3.2	16:05	4.1	3.5	22:40	0.5	16:05	0.9	0.7	22:40	0.055	16:05	0.115	0.079	0.079	0.01		
3/2/2018	21:50	3.0	16:00	4.0	3.4	19:45	0.5	16:00	0.8	0.6	21:50	0.049	16:00	0.107	0.068	0.068	0.07		
3/3/2018	5:30	2.9	12:05	3.4	3.1	9:25	0.4	12:05	0.7	0.5	9:25	0.040	12:05	0.072	0.050	0.050	0.00		
3/4/2018	4:50	2.8	17:40	3.3	2.9	5:35	0.4	17:40	0.6	0.5	5:35	0.029	17:40	0.066	0.041	0.041	0.12		
3/5/2018	1:05	3.1	14:15	4.9	3.5	19:50	0.6	14:15	1.0	0.7	1:05	0.054	14:15	0.170	0.076	0.076	0.00		
3/6/2018	23:30	3.1	11:25	4.4	3.5	23:40	0.5	11:25	0.9	0.7	23:40	0.048	11:25	0.133	0.076	0.076	0.00		
3/7/2018	2:40	3.0	14:05	5.2	3.5	2:40	0.4	14:05	1.0	0.7	2:40	0.039	14:05	0.185	0.075	0.075	0.03		
3/8/2018	2:20	3.1	15:20	4.1	3.5	2:15	0.5	15:20	0.9	0.7	2:15	0.043	15:20	0.115	0.073	0.073	0.37		
3/9/2018	22:10	3.0	13:00	4.4	3.4	22:55	0.5	13:00	0.9	0.6	22:55	0.043	13:00	0.139	0.069	0.069	0.00		
3/10/2018	3:55	2.9	14:55	3.3	3.1	2:55	0.4	18:30	0.6	0.5	2:55	0.037	18:30	0.062	0.048	0.048	0.00		
3/11/2018	0:45	2.9	15:00	3.4	3.0	2:35	0.4	15:00	0.7	0.5	2:35	0.035	15:00	0.070	0.046	0.046	0.00		
3/12/2018	1:40	3.1	14:20	4.1	3.5	0:35	0.5	14:20	0.9	0.7	0:35	0.046	14:20	0.116	0.073	0.073	0.00		
3/13/2018	2:05	3.2	14:15	4.2	3.5	23:30	0.5	14:15	0.9	0.7	23:30	0.053	14:15	0.124	0.077	0.077	0.31		
3/14/2018	23:15	3.0	9:05	3.9	3.5	23:15	0.5	6:50	0.8	0.6	23:15	0.042	6:50	0.099	0.071	0.071	0.04		
3/15/2018	1:30	3.0	9:40	4.3	3.5	2:10	0.5	9:40	0.9	0.6	2:10	0.042	9:40	0.128	0.072	0.072	0.00		
3/16/2018	23:40	3.1	13:15	4.1	3.5	23:50	0.5	13:15	0.9	0.7	23:50	0.044	13:15	0.120	0.073	0.073	0.00		
3/17/2018	23:25	3.0	13:25	3.9	3.1	4:25	0.4	13:25	0.7	0.5	4:25	0.038	13:25	0.092	0.050	0.050	0.00		
3/18/2018	23:45	2.9	17:05	3.2	3.0	23:05	0.4	17:05	0.6	0.5	11:05	0.038	17:05	0.061	0.046	0.046	0.00		
3/19/2018	2:00	2.9	13:35	4.0	3.4	3:55	0.4	13:35	0.8	0.7	3:55	0.034	13:35	0.107	0.073	0.073	0.00		
3/20/2018	5:10	3.2	9:15	4.3	3.5	22:15	0.5	9:15	0.9	0.7	22:15	0.050	9:15	0.132	0.075	0.075	0.00		
3/21/2018	23:55	3.0	12:50	4.2	3.4	2:20	0.5	12:50	0.9	0.6	2:20	0.041	12:50	0.124	0.066	0.066	0.10		
3/22/2018	2:20	2.8	10:20	4.7	3.4	2:15	0.4	10:20	1.0	0.6	2:15	0.029	10:20	0.161	0.069	0.069	0.48		
3/23/2018	4:15	2.9	9:35	4.1	3.4	4:25	0.5	9:35	0.8	0.7	4:25	0.041	9:35	0.115	0.072	0.072	0.31		
3/24/2018	22:50	2.8	9:20	3.6	3.1	22:45	0.4	9:20	0.7	0.6	22:50	0.036	9:20	0.082	0.052	0.052	0.28		
3/25/2018	0:05	2.8	19:00	3.2	2.9	21:00	0.4	12:50	0.6	0.5	21:00	0.032	12:50	0.062	0.042	0.042	0.01		
3/26/2018	3:20	2.8	10:15	4.4	3.4	3:20	0.4	10:15	0.9	0.6	3:20	0.028	10:15	0.137	0.068	0.068	0.17		
3/27/2018	0:10	3.1	11:50	4.3	3.5	0:10	0.5	11:50	0.9	0.7	0:10	0.044	11:50	0.129	0.075	0.075	0.02		
3/28/2018	23:55	3.0	12:00	4.0	3.4	23:35	0.4	12:00	0.8	0.6	23:35	0.041	12:00	0.112	0.066	0.066	0.01		
3/29/2018	1:55	2.9	12:55	4.1	3.4	1:55	0.4	12:55	0.9	0.6	1:55	0.034	12:55	0.120	0.068	0.068	0.00		
3/30/2018	1:40	3.0	12:15	4.0	3.4	1:40	0.4	12:15	0.8	0.6	1:40	0.039	12:15	0.108	0.068	0.068	0.00		
3/31/2018	23:10	2.9	12:55	3.3	3.1	23:10	0.4	10:15	0.6	0.5	23:10	0.036	10:15	0.063	0.050	0.050	0.00		
ReportAvg					3.3					0.6							0.065		
ReportTotal																	2.006	2.33	

ADS Environmental Services

Pipe Height: 9.88

Date	REN_MH0286\mp1\DFINAL (inches)					REN_MH0286\mp1\VFINAL (feet/sec)					REN_MH0286\mp1\QFINAL (MGD - Total MG)						REN_RG\mp1\RAIN (inches)	
	Time	Min.	Time	Max.	Average	Time	Min.	Time	Max.	Average	Time	Min.	Time	Max.	Average	Total	Total	
4/1/2018	23:15	2.9	17:25	3.2	3.0	23:15	0.4	17:25	0.6	0.5	23:15	0.033	17:25	0.059	0.045	0.045	0.10	
4/2/2018	2:35	2.9	10:45	5.9	3.4	1:55	0.4	10:50	1.0	0.7	1:55	0.033	10:45	0.212	0.073	0.073	0.00	
4/3/2018	2:05	2.9	17:55	4.1	3.5	2:00	0.4	17:55	0.9	0.7	2:00	0.036	17:55	0.120	0.078	0.078	0.00	
4/4/2018	1:55	3.1	14:50	4.1	3.5	21:55	0.5	14:50	0.9	0.7	21:55	0.045	14:50	0.115	0.073	0.073	0.39	
4/5/2018	4:25	3.2	12:55	4.0	3.5	2:30	0.5	12:55	0.8	0.7	2:30	0.056	12:55	0.113	0.077	0.077	0.25	
4/6/2018	23:55	2.9	12:40	4.1	3.4	21:45	0.5	12:40	0.8	0.7	21:45	0.041	12:40	0.115	0.071	0.071	0.00	
4/7/2018	0:25	2.9	9:30	3.6	3.2	1:05	0.4	9:30	0.7	0.6	1:05	0.034	9:30	0.085	0.059	0.059	0.88	
4/8/2018	16:40	3.0	10:55	3.4	3.2	17:05	0.5	10:55	0.7	0.6	17:05	0.042	10:55	0.072	0.058	0.058	0.45	
4/9/2018	0:00	3.0	11:05	4.2	3.6	0:30	0.5	11:05	0.9	0.7	0:05	0.043	11:05	0.125	0.084	0.084	0.00	
4/10/2018	22:15	3.3	10:30	4.5	3.7	22:15	0.6	10:30	0.9	0.8	22:15	0.063	10:30	0.145	0.091	0.091	0.23	
4/11/2018	2:05	3.4	6:45	4.4	3.8	2:05	0.7	6:45	0.9	0.8	2:05	0.068	6:45	0.140	0.094	0.094	0.31	
4/12/2018	4:30	3.5	14:25	4.3	3.8	4:30	0.7	14:25	0.9	0.8	4:30	0.074	14:25	0.130	0.097	0.097	0.11	
4/13/2018	23:55	3.3	15:05	4.3	3.7	21:50	0.5	15:05	0.9	0.7	21:50	0.056	15:05	0.132	0.090	0.090	0.51	
4/14/2018	2:55	3.1	13:20	4.5	3.5	4:45	0.5	13:20	0.9	0.7	4:45	0.049	13:20	0.142	0.076	0.076	1.52	
4/15/2018	20:30	3.3	6:50	4.2	3.6	19:45	0.6	6:50	0.9	0.7	19:45	0.060	6:50	0.121	0.081	0.081	0.21	
4/16/2018	2:30	3.3	14:55	5.0	3.8	4:20	0.6	14:55	1.0	0.8	4:20	0.060	14:55	0.174	0.095	0.095	0.71	
4/17/2018	22:30	3.3	11:15	4.2	3.7	22:15	0.6	11:15	0.9	0.7	22:15	0.057	11:15	0.127	0.089	0.089	0.01	
4/18/2018	3:45	3.2	15:50	4.4	3.6	4:05	0.5	15:50	0.9	0.7	4:05	0.053	15:50	0.138	0.084	0.084	0.12	
4/19/2018	1:55	3.1	9:45	4.3	3.5	5:40	0.5	9:45	0.9	0.7	5:40	0.053	9:45	0.129	0.079	0.079	0.00	
4/20/2018	23:55	3.1	9:50	4.2	3.5	21:15	0.5	9:50	0.9	0.7	21:15	0.050	9:50	0.122	0.078	0.078	0.00	
4/21/2018	7:30	2.9	19:20	3.8	3.1	7:20	0.5	19:20	0.8	0.6	7:20	0.041	19:20	0.096	0.055	0.055	0.05	
4/22/2018	6:50	2.8	2:25	3.2	3.0	10:35	0.4	2:25	0.6	0.5	8:25	0.033	2:25	0.058	0.046	0.046	0.00	
ReportAvg	3.5					0.7					0.076							
ReportTotal																	1.671	5.85

REN_MH0537

Located At: 2803 Burnett Ave (see attached site report for details)
Monitoring Period: December 22, 2017 – April 22, 2018
Pipe Dimensions: 8"
Finalized Silt Level: 0 mm

Site Data Characteristics: This site is located in a sanitary sewer pipe. The scattergraph indicates site operated in free flow conditions. The site did not surcharge during the monitoring period. The dry weather data plots above the Froude =1 curve indicating supercritical flow.

Site Data Bias & Editing: The depth and velocity measurements recorded by the flow monitor were consistent with field confirmations conducted to date and supported the relative accuracy of the flow monitor at this location. The finalized depth data utilized the upward ultrasonic sensor.

Site Data Uptime: The data uptime achieved during the monitoring period is provided in the table below. Based upon the quality and consistency of the observed flow depth and velocity data, the Continuity equation was used to calculate the flow rate for the monitoring period.

Entity	Percentage Uptime	
	Raw	Final
Depth (in)	100%	100%
Velocity (f/s)	100%	100%
Quantity (mgd)	100%	100%

Site Data Summary: The average flow depth, velocity, and quantity data observed during the monitoring period along with observed minimum and maximum data, are provided in the following table. The minimum and maximum rates recorded in the tables are based on 5-minute data intervals.

Item	Depth (in)	Velocity (f/s)	Quantity (mgd)	% Full
Minimum	1.21	6.33	0.141	15%
Maximum	2.90	10.62	0.766	36%
Average	1.77	8.86	0.336	22%

Renton.Carollo.I&I.WA17



Site Name

REN_MH0537

Flow Monitoring Site Report

Site Address /Location: ADJ 2803 Burnett Ave Nth

Monitor Series

TRITON+

Location Type

Temporary

Site Access Details: Located in roadway, at intersection. Requires traffic control.

Latitude: 47.516545°

Longitude: -122.207103°

Pipe Size (H x W)

8.00" x 8.00"

Pipe Shape

Circular

Manhole #

MH0537

System Characteristics

Other

Access

Drive

Traffic

Medium

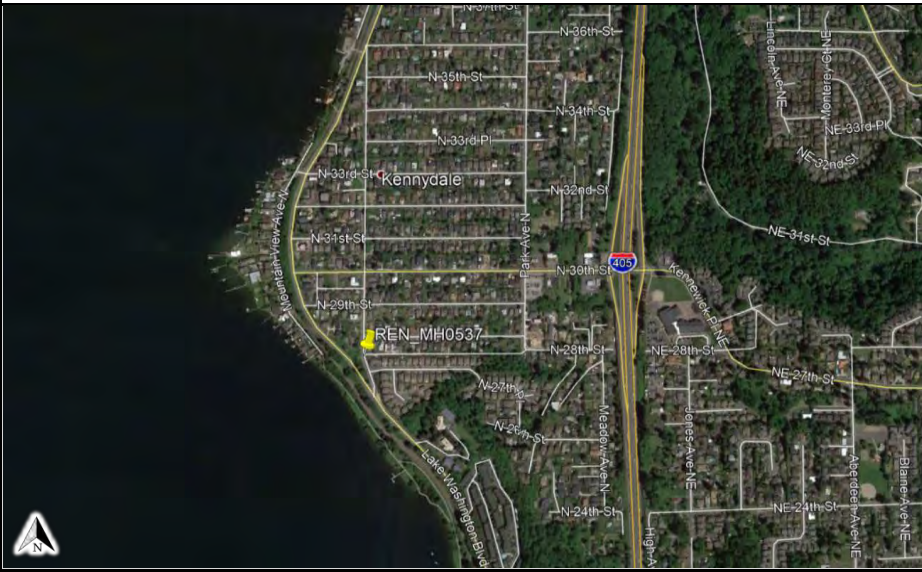

Installation Information

Installation Date:	12.19.17	Installation Type:	Doppler Standard Ring and Crank
Monitoring Location (Sensors):	Upstream 0-5 FT	Monitor Location:	Manhole
Sensors / Devices:	Peak Combo (CS4), Smart Depth (CS5)	Pressure Sensor Range (psi)	0 - 5 psi

Installation Confirmation:

Confirmation Time:	1:05:00 PM	Pipe Size (HxW)	8.00" x 8.00"
Depth of Flow (Wet DOF) (in)	~1.75"	Range (Air DOF) (in)	
Downlooker Physical Offset (in)	1.38"	Measurement Confidence (in)	0.25"
Peak Velocity (fps)	9.60 FPS	Velocity Sensor Offset (in)	
Silt (in)	0	Silt Type	

Hydraulic Comments:

Low, fast flow

Manhole / Pipe Information:

Manhole Depth (Approx. FT):	~10'	Manhole Configuration	Single
Manhole Material:	Concrete	Manhole Condition:	Good
Manhole Opening Diameter (in)	20"	Manhole Diameter (Approx.):	20"
Manhole Cover	Unbolted	Manhole Frame	Normal
Active Drop Connections	No	Air Quality:	Normal
Pipe Material	Concrete	Pipe Condition:	Good

Communication Information:

Communication Type	Wireless	Antenna Location	Manhole Pick / Vent Hole
--------------------	----------	------------------	--------------------------

Additional Site Info. / Comments:

Site located in roadway. Traffic control required.

ADS Project Name:	Renton.Carollo.I&I.WA17
ADS Project Number:	22275.11.325

Additional Photos

Upstream



Downstream



Overflow



Top Down



Location



Location



- Flow Direction
- ⊗ Monitoring Point

HYDROGRAPH REPORT

REN_MH0537

Flow Monitor
REN_MH0537

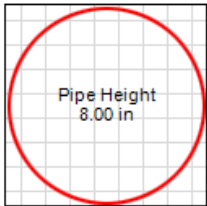

Report Period
12/22/2017
To
4/22/2018

Legend
— Depth
— Velocity
— Rain

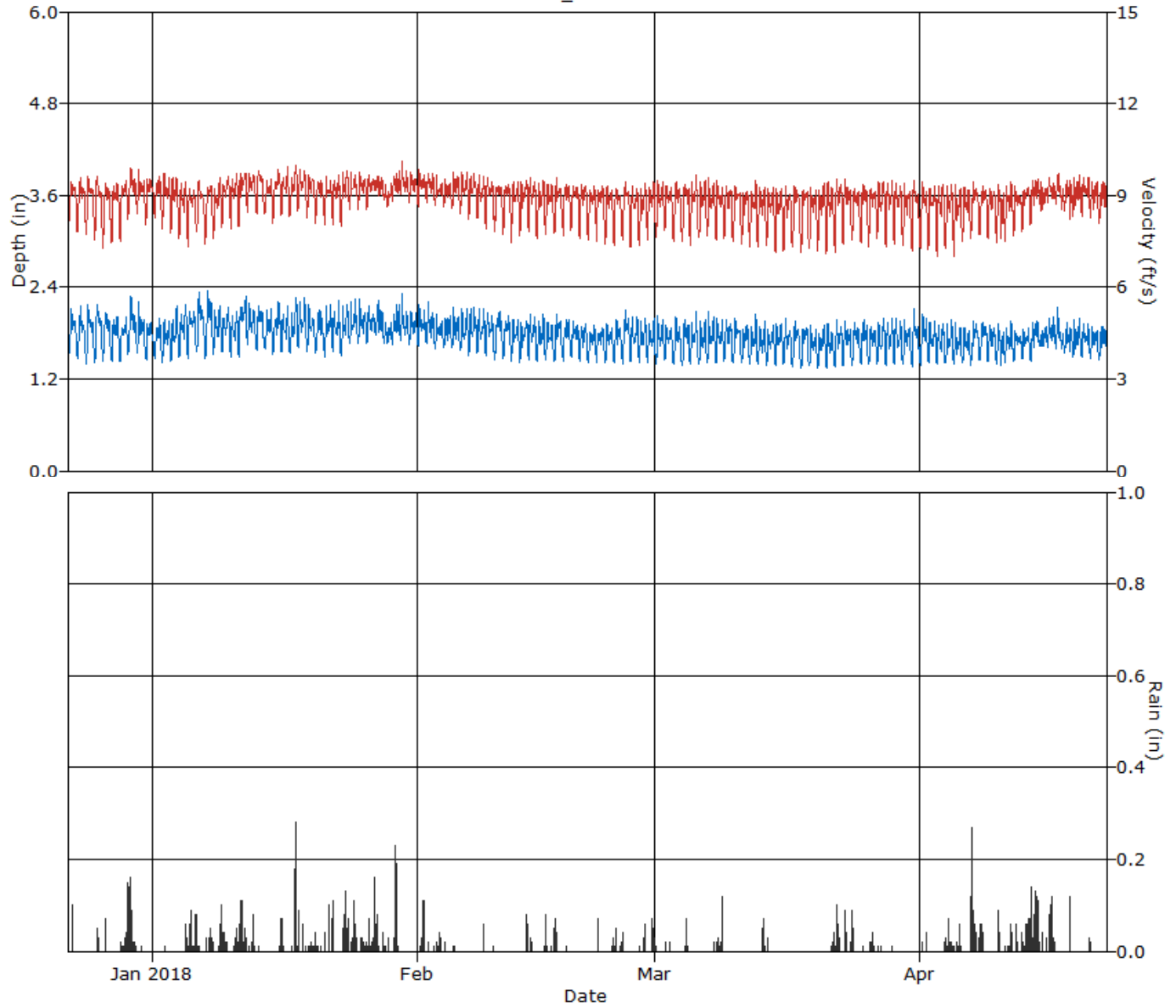

HYDROGRAPH REPORT

REN_MH0537

Flow Monitor
REN_MH0537

Pipe Height
8.00 in.

Report Period
12/22/2017
To
4/22/2018

Legend
— Quantity
— Rain

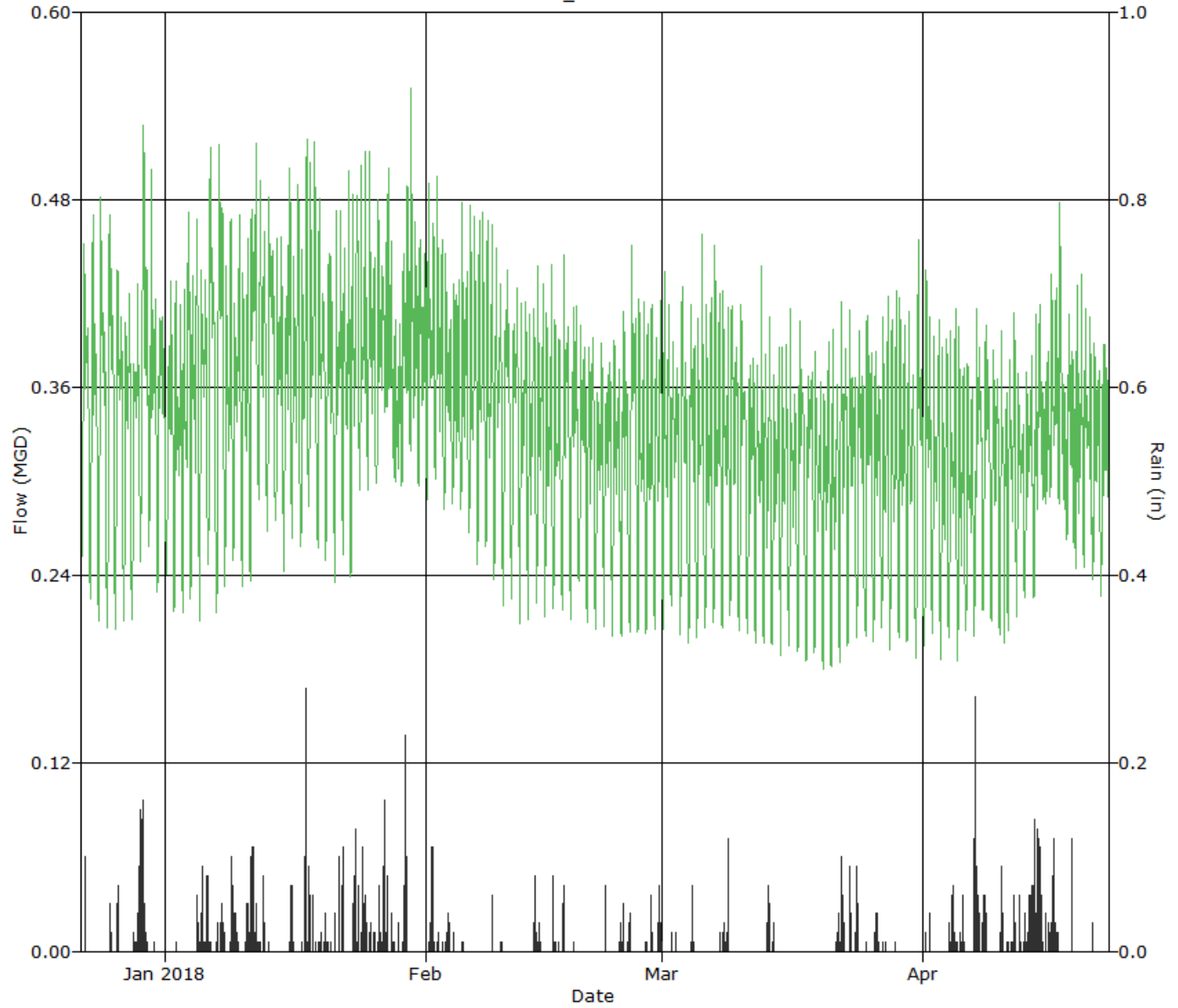

SCATTERGRAPH REPORT

REN_MH0537

Flow Monitor
REN_MH0537

Pipe Height
8.00 in

Report Period
12/22/2017
To
4/22/2018

- Legend**
- Depth - Velocity
 - - - Iso-Q™
 - - - Silt
 - ▼ Min-Max Depth

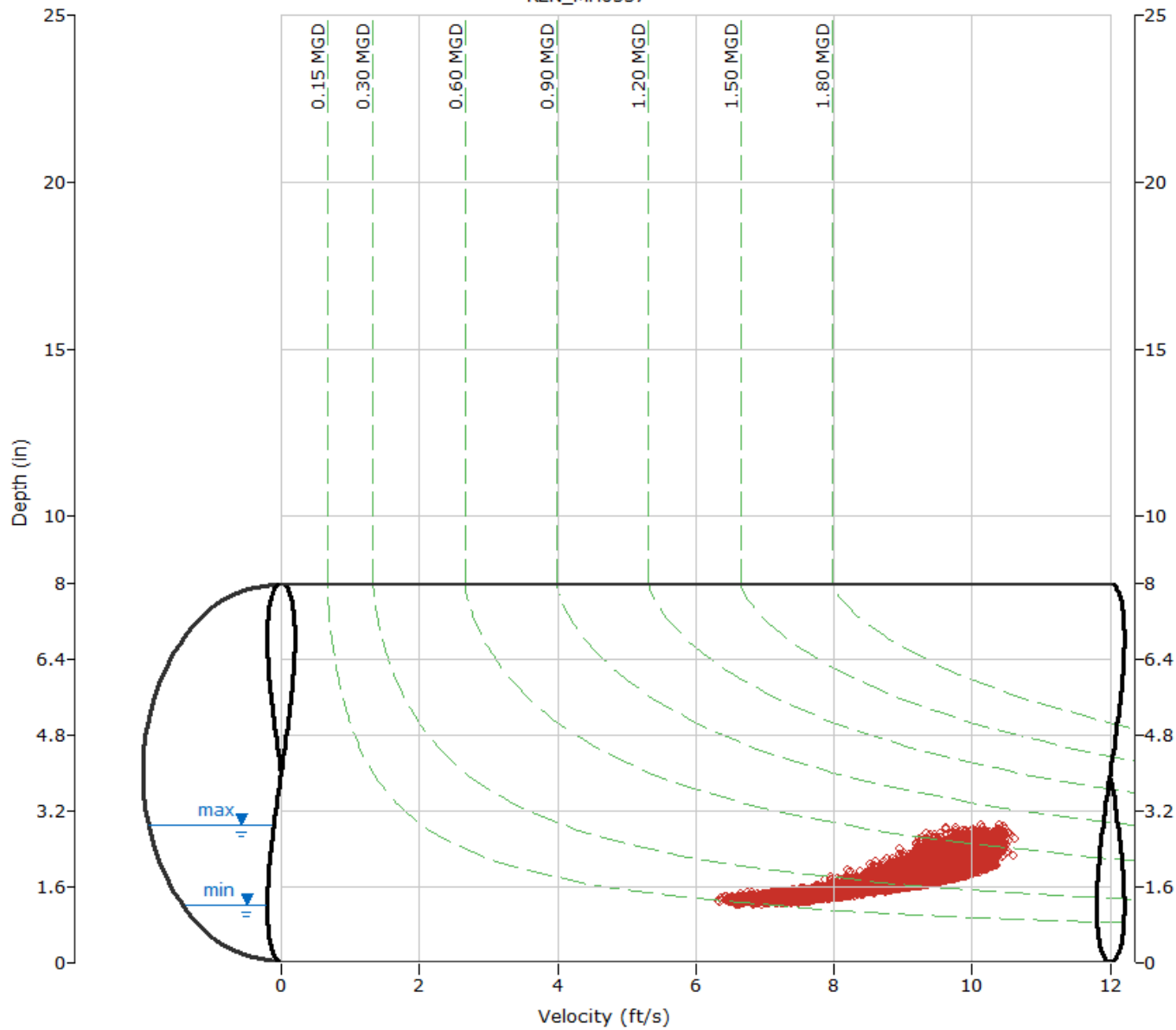

ADS Environmental Services

Pipe Height: 8.00

Date	REN_MH0537\mp1\DFINAL (inches)					REN_MH0537\mp1\VFINAL (feet/sec)					REN_MH0537\mp1\QFINAL (MGD - Total MG)					REN_RG\mp1\RAIN (inches)	
	Time	Min.	Time	Max.	Average	Time	Min.	Time	Max.	Average	Time	Min.	Time	Max.	Average	Total	Total
12/22/2017	4:40	1.3	10:15	2.6	1.8	3:55	7.2	10:15	10.0	8.9	3:55	0.182	10:15	0.630	0.356	0.356	0.10
12/23/2017	4:40	1.3	9:55	2.6	1.8	4:30	6.9	7:55	10.0	8.9	4:30	0.167	9:55	0.630	0.344	0.344	0.00
12/24/2017	6:40	1.2	10:45	2.7	1.8	4:15	7.0	10:40	10.2	8.9	5:10	0.159	10:45	0.665	0.347	0.347	0.00
12/25/2017	3:10	1.2	11:40	2.6	1.8	4:05	6.8	11:45	10.1	8.8	4:05	0.158	11:40	0.629	0.354	0.354	0.14
12/26/2017	5:15	1.3	10:40	2.5	1.8	4:20	6.6	9:15	10.0	8.7	5:15	0.156	11:10	0.581	0.342	0.342	0.17
12/27/2017	5:45	1.3	20:45	2.5	1.8	4:10	6.6	9:30	9.9	8.7	4:10	0.155	20:45	0.599	0.331	0.331	0.00
12/28/2017	4:30	1.3	8:20	2.7	1.7	4:50	6.7	20:05	10.2	8.8	4:50	0.155	8:20	0.652	0.328	0.328	0.25
12/29/2017	3:25	1.4	10:25	2.8	1.9	2:40	7.6	10:25	10.5	9.2	3:20	0.194	10:25	0.753	0.387	0.387	1.57
12/30/2017	5:00	1.4	10:40	2.8	1.8	5:00	7.5	10:40	10.4	9.1	5:00	0.192	10:40	0.722	0.357	0.357	0.02
12/31/2017	4:00	1.3	17:25	2.6	1.8	3:55	7.3	10:05	10.4	9.1	3:55	0.176	17:25	0.659	0.339	0.339	0.00
ReportAvg	1.8					8.9					0.349						
ReportTotal																3.486	2.25

ADS Environmental Services

Pipe Height: 8.00

Date	REN_MH0537\mp1\DFINAL (inches)					REN_MH0537\mp1\VFINAL (feet/sec)					REN_MH0537\mp1\QFINAL (MGD - Total MG)					REN_RG\mp1\RAIN (inches)	
	Time	Min.	Time	Max.	Average	Time	Min.	Time	Max.	Average	Time	Min.	Time	Max.	Average	Total	Total
1/1/2018	5:50	1.3	21:00	2.4	1.7	5:50	7.3	11:35	10.3	9.1	5:50	0.174	21:00	0.590	0.334	0.334	0.00
1/2/2018	3:20	1.2	20:15	2.6	1.7	4:05	6.9	7:40	10.5	9.0	3:15	0.159	20:15	0.630	0.330	0.330	0.01
1/3/2018	2:35	1.3	20:25	2.7	1.8	4:00	6.7	6:45	10.2	9.0	4:00	0.163	20:25	0.673	0.345	0.345	0.00
1/4/2018	3:45	1.3	20:35	2.6	1.8	3:45	6.6	8:20	10.1	8.7	3:45	0.163	20:35	0.619	0.352	0.352	0.09
1/5/2018	3:20	1.3	20:45	2.6	1.9	4:00	6.6	20:45	10.0	8.6	4:00	0.161	20:45	0.632	0.355	0.355	0.42
1/6/2018	3:40	1.3	12:25	2.8	1.9	3:35	6.9	10:45	9.9	8.8	3:35	0.176	12:25	0.684	0.377	0.377	0.24
1/7/2018	3:55	1.3	11:25	2.8	1.9	3:55	6.6	21:00	9.9	8.7	3:55	0.162	11:25	0.696	0.377	0.377	0.38
1/8/2018	3:40	1.4	20:15	2.6	1.9	4:20	6.8	21:50	10.0	8.7	4:20	0.178	20:15	0.618	0.357	0.357	0.14
1/9/2018	4:40	1.4	21:00	2.6	1.9	4:40	7.0	19:05	10.3	9.0	4:40	0.179	21:00	0.646	0.366	0.366	0.46
1/10/2018	4:55	1.4	19:25	2.7	1.8	3:35	7.2	19:25	10.3	9.0	3:40	0.184	19:25	0.675	0.354	0.354	0.22
1/11/2018	4:10	1.4	22:00	2.8	1.9	3:35	7.1	7:20	10.3	9.2	3:35	0.186	22:00	0.694	0.399	0.399	1.04
1/12/2018	3:30	1.4	9:25	2.7	1.9	2:30	7.5	9:00	10.3	9.3	3:00	0.205	7:55	0.658	0.391	0.391	0.20
1/13/2018	2:35	1.3	9:50	2.7	1.9	6:20	7.5	11:15	10.3	9.3	2:35	0.195	9:50	0.682	0.385	0.385	0.02
1/14/2018	4:30	1.4	9:55	2.8	1.8	4:30	7.3	9:15	10.3	9.1	4:30	0.187	9:55	0.691	0.362	0.362	0.00
1/15/2018	2:45	1.4	20:15	2.8	1.9	3:55	7.1	20:55	10.3	9.1	4:30	0.183	20:55	0.705	0.373	0.373	0.04
1/16/2018	3:30	1.3	21:55	2.7	1.8	4:00	7.3	19:15	10.3	9.2	3:30	0.185	21:55	0.666	0.367	0.367	0.26
1/17/2018	3:00	1.3	20:20	2.8	1.9	4:10	7.1	20:00	10.6	9.2	3:00	0.177	20:20	0.710	0.378	0.378	0.79
1/18/2018	0:05	1.3	20:50	2.8	1.9	0:05	6.9	20:10	10.4	9.3	0:05	0.155	20:50	0.694	0.399	0.399	0.40
1/19/2018	2:10	1.4	8:00	2.7	1.9	4:20	7.4	8:00	10.3	9.2	3:50	0.194	8:00	0.675	0.374	0.374	0.10
1/20/2018	6:10	1.4	12:20	2.9	1.8	3:20	7.3	12:20	10.1	9.1	3:20	0.186	12:20	0.742	0.364	0.364	0.10
1/21/2018	5:20	1.3	9:50	2.8	1.8	3:35	7.2	9:50	10.2	8.9	5:20	0.180	9:50	0.700	0.353	0.353	0.16
1/22/2018	3:50	1.4	8:55	2.7	1.9	3:50	7.1	17:50	10.2	9.0	3:50	0.180	8:55	0.686	0.365	0.365	0.34
1/23/2018	3:35	1.3	20:50	2.8	1.9	3:00	7.0	7:40	10.3	9.2	3:00	0.173	20:50	0.701	0.376	0.376	0.79
1/24/2018	3:30	1.4	8:15	2.8	1.9	3:30	7.7	8:15	10.5	9.2	3:30	0.207	8:15	0.733	0.385	0.385	0.51
1/25/2018	3:35	1.4	7:50	2.7	1.9	4:30	7.7	7:50	10.4	9.3	3:35	0.216	7:50	0.717	0.396	0.396	0.14
1/26/2018	3:55	1.4	8:40	2.6	1.9	3:25	7.5	9:05	10.3	9.2	3:55	0.206	8:40	0.661	0.388	0.388	0.36
1/27/2018	2:55	1.5	10:20	2.8	1.9	4:40	8.2	8:55	10.4	9.3	4:40	0.254	10:20	0.728	0.399	0.399	0.61
1/28/2018	6:05	1.4	10:15	2.8	1.8	4:40	7.7	7:35	10.2	9.0	4:40	0.220	10:15	0.724	0.347	0.347	0.07
1/29/2018	4:55	1.4	21:55	2.7	1.9	3:50	7.9	22:35	10.4	9.3	4:55	0.218	21:55	0.712	0.387	0.387	0.90
1/30/2018	4:10	1.5	9:10	2.7	1.9	6:45	8.1	18:00	10.6	9.4	3:40	0.237	21:10	0.706	0.396	0.396	0.00
1/31/2018	2:30	1.4	21:40	2.8	1.9	3:30	8.0	17:25	10.5	9.3	2:30	0.219	21:40	0.716	0.386	0.386	0.00
ReportAvg	1.9					9.1					0.372						
ReportTotal																11.52	8.79

ADS Environmental Services

Pipe Height: 8.00

Date	REN_MH0537\mp1\DFINAL (inches)					REN_MH0537\mp1\VFINAL (feet/sec)					REN_MH0537\mp1\QFINAL (MGD - Total MG)						REN_RG\mp1\RAIN (inches)	
	Time	Min.	Time	Max.	Average	Time	Min.	Time	Max.	Average	Time	Min.	Time	Max.	Average	Total	Total	
2/1/2018	4:10	1.4	21:00	2.9	1.9	4:10	7.8	6:40	10.4	9.3	4:10	0.205	21:00	0.766	0.383	0.383	0.66	
2/2/2018	5:15	1.4	8:25	2.7	1.9	3:15	7.8	8:05	10.4	9.3	3:45	0.218	8:25	0.707	0.387	0.387	0.04	
2/3/2018	6:05	1.4	13:10	2.6	1.8	6:05	7.8	8:35	10.4	9.1	6:05	0.202	13:10	0.663	0.354	0.354	0.31	
2/4/2018	5:10	1.4	15:45	2.7	1.8	5:10	7.6	8:30	10.3	9.1	5:10	0.202	15:45	0.675	0.361	0.361	0.02	
2/5/2018	4:40	1.4	21:40	2.7	1.9	3:05	7.5	21:40	10.5	9.2	4:40	0.201	21:40	0.708	0.372	0.372	0.04	
2/6/2018	3:00	1.4	7:10	2.7	1.8	3:30	7.3	7:10	10.6	9.2	3:30	0.190	7:10	0.704	0.361	0.361	0.00	
2/7/2018	3:20	1.4	7:35	2.7	1.8	2:45	7.4	6:45	10.3	9.1	3:20	0.187	7:35	0.663	0.359	0.359	0.00	
2/8/2018	4:35	1.3	8:25	2.7	1.8	3:25	7.2	8:05	10.2	9.0	3:25	0.181	8:25	0.668	0.356	0.356	0.09	
2/9/2018	4:35	1.3	7:45	2.6	1.8	2:00	7.2	7:45	10.3	9.0	2:40	0.183	7:45	0.649	0.349	0.349	0.01	
2/10/2018	5:55	1.3	9:10	2.7	1.8	5:15	6.9	9:10	10.4	8.9	5:15	0.170	9:10	0.689	0.344	0.344	0.01	
2/11/2018	4:10	1.3	20:40	2.5	1.8	3:25	7.0	9:25	10.0	8.9	4:50	0.171	20:40	0.599	0.341	0.341	0.00	
2/12/2018	4:40	1.3	21:15	2.6	1.8	3:55	6.8	7:30	10.3	8.8	4:40	0.161	21:15	0.643	0.332	0.332	0.00	
2/13/2018	4:00	1.3	7:55	2.5	1.7	4:00	6.9	7:55	10.2	8.9	4:00	0.164	7:55	0.621	0.329	0.329	0.17	
2/14/2018	3:30	1.3	20:20	2.7	1.8	4:10	6.9	6:25	10.2	8.9	4:10	0.171	20:20	0.644	0.334	0.334	0.15	
2/15/2018	4:00	1.3	21:30	2.6	1.7	2:20	6.9	21:30	10.1	8.8	3:10	0.166	21:30	0.638	0.327	0.327	0.00	
2/16/2018	4:35	1.3	7:40	2.6	1.7	4:30	6.9	7:40	10.3	8.8	4:30	0.167	7:40	0.652	0.322	0.322	0.15	
2/17/2018	4:20	1.3	10:10	2.8	1.8	2:50	6.7	9:50	10.2	8.8	2:50	0.161	10:10	0.688	0.333	0.333	0.32	
2/18/2018	4:55	1.3	20:25	2.6	1.8	4:55	7.0	9:10	10.1	8.8	4:55	0.170	9:10	0.626	0.331	0.331	0.01	
2/19/2018	3:50	1.3	18:50	2.5	1.7	3:50	6.8	21:30	10.0	8.8	3:50	0.159	18:50	0.609	0.323	0.323	0.00	
2/20/2018	4:05	1.3	10:20	2.5	1.7	3:15	6.8	10:20	10.2	8.8	3:15	0.166	10:20	0.611	0.319	0.319	0.00	
2/21/2018	4:00	1.3	20:40	2.7	1.7	4:00	6.7	20:20	10.1	8.7	4:00	0.156	20:40	0.682	0.311	0.311	0.00	
2/22/2018	3:15	1.3	7:15	2.4	1.7	4:55	6.6	19:05	10.2	8.8	3:20	0.160	7:15	0.588	0.315	0.315	0.07	
2/23/2018	3:30	1.3	10:15	2.5	1.7	3:30	6.6	7:25	10.0	8.7	3:30	0.154	10:15	0.585	0.312	0.312	0.01	
2/24/2018	4:05	1.3	10:10	2.6	1.7	5:05	6.6	10:40	9.9	8.6	5:05	0.155	10:10	0.627	0.313	0.313	0.13	
2/25/2018	5:10	1.2	21:30	2.6	1.8	4:20	6.7	11:05	10.1	8.6	5:10	0.156	11:05	0.652	0.329	0.329	0.11	
2/26/2018	2:55	1.3	21:15	2.6	1.7	3:45	6.6	21:15	9.9	8.5	2:55	0.157	21:15	0.618	0.316	0.316	0.00	
2/27/2018	3:35	1.3	20:25	2.6	1.7	3:30	6.5	19:05	10.2	8.6	3:30	0.151	20:25	0.639	0.315	0.315	0.19	
2/28/2018	3:25	1.3	7:35	2.6	1.7	3:20	6.7	19:20	10.2	8.8	3:20	0.157	7:35	0.623	0.318	0.318	0.35	
ReportAvg	1.8					8.9					0.337							
ReportTotal											9.447						2.84	

ADS Environmental Services

Pipe Height: 8.00

Date	REN_MH0537\mp1\DFINAL (inches)					REN_MH0537\mp1\VFINAL (feet/sec)					REN_MH0537\mp1\QFINAL (MGD - Total MG)					REN_RG\mp1\RAIN (inches)	
	Time	Min.	Time	Max.	Average	Time	Min.	Time	Max.	Average	Time	Min.	Time	Max.	Average	Total	Total
3/1/2018	3:55	1.3	20:55	2.6	1.7	3:30	6.7	6:55	10.3	8.8	3:30	0.159	6:55	0.655	0.324	0.324	0.01
3/2/2018	4:00	1.3	7:20	2.5	1.7	3:15	7.1	7:50	10.1	8.8	4:00	0.172	7:20	0.609	0.316	0.316	0.07
3/3/2018	2:10	1.3	11:25	2.6	1.7	4:55	6.6	9:45	10.4	8.8	5:50	0.157	9:15	0.652	0.320	0.320	0.00
3/4/2018	5:25	1.3	21:35	2.7	1.7	5:15	6.8	11:45	10.2	8.7	5:15	0.156	11:45	0.667	0.315	0.315	0.12
3/5/2018	1:55	1.3	19:30	2.6	1.7	4:00	6.6	19:30	10.4	8.8	4:50	0.154	19:30	0.658	0.322	0.322	0.00
3/6/2018	3:40	1.3	20:35	2.6	1.7	3:40	6.7	20:35	10.4	8.8	3:40	0.154	20:35	0.677	0.317	0.317	0.00
3/7/2018	2:30	1.3	7:50	2.6	1.7	3:25	6.9	7:25	10.1	8.8	3:25	0.166	7:50	0.648	0.324	0.324	0.03
3/8/2018	4:25	1.3	21:55	2.5	1.7	4:25	6.8	6:50	10.1	8.7	4:25	0.155	21:55	0.602	0.319	0.319	0.37
3/9/2018	2:55	1.3	8:05	2.6	1.7	2:50	6.9	8:00	10.2	8.7	2:50	0.164	8:00	0.642	0.323	0.323	0.00
3/10/2018	4:25	1.3	10:25	2.6	1.7	5:20	6.6	10:30	10.1	8.7	5:20	0.155	10:25	0.654	0.319	0.319	0.00
3/11/2018	5:30	1.3	18:50	2.5	1.7	4:25	6.6	20:50	10.1	8.5	5:30	0.148	18:50	0.588	0.298	0.298	0.00
3/12/2018	4:25	1.2	20:25	2.4	1.7	2:25	6.6	20:50	10.0	8.6	2:25	0.150	20:25	0.584	0.302	0.302	0.00
3/13/2018	2:45	1.3	18:20	2.7	1.7	2:40	6.5	18:20	10.4	8.6	2:40	0.149	18:20	0.709	0.303	0.303	0.31
3/14/2018	3:50	1.3	21:45	2.5	1.7	2:00	6.4	7:25	10.2	8.5	3:50	0.148	7:25	0.583	0.297	0.297	0.04
3/15/2018	3:45	1.3	19:10	2.4	1.7	2:40	6.3	12:20	10.0	8.5	2:40	0.151	19:10	0.551	0.306	0.306	0.00
3/16/2018	2:50	1.3	6:45	2.5	1.7	2:30	6.5	7:45	9.9	8.5	2:50	0.147	6:45	0.574	0.300	0.300	0.00
3/17/2018	1:50	1.2	9:10	2.6	1.7	2:55	6.4	8:15	10.1	8.5	2:55	0.145	9:10	0.650	0.303	0.303	0.00
3/18/2018	4:45	1.3	20:25	2.7	1.7	4:35	6.5	17:45	10.0	8.5	4:35	0.149	20:25	0.652	0.300	0.300	0.00
3/19/2018	5:00	1.2	6:50	2.4	1.6	3:00	6.5	6:50	10.0	8.5	3:00	0.148	6:50	0.569	0.290	0.290	0.00
3/20/2018	4:50	1.3	19:10	2.5	1.6	2:40	6.6	6:45	10.3	8.6	2:40	0.150	19:10	0.630	0.294	0.294	0.00
3/21/2018	22:25	1.2	7:45	2.5	1.6	2:35	6.5	5:40	10.2	8.6	2:35	0.147	18:00	0.589	0.291	0.291	0.10
3/22/2018	2:35	1.3	19:15	2.6	1.7	2:40	6.4	7:35	10.2	8.7	2:30	0.148	19:15	0.659	0.312	0.312	0.48
3/23/2018	2:15	1.3	6:35	2.3	1.7	2:05	6.6	8:05	10.1	8.7	2:05	0.152	8:05	0.547	0.308	0.308	0.31
3/24/2018	3:20	1.3	9:35	2.6	1.7	2:25	6.7	9:40	9.9	8.6	3:20	0.156	9:35	0.631	0.307	0.307	0.28
3/25/2018	5:25	1.3	8:10	2.6	1.7	5:15	6.7	7:30	10.2	8.6	5:25	0.154	8:10	0.636	0.303	0.303	0.01
3/26/2018	2:45	1.3	18:20	2.8	1.7	2:45	6.6	20:30	10.3	8.7	2:45	0.150	18:20	0.698	0.308	0.308	0.17
3/27/2018	5:05	1.2	20:45	2.6	1.7	5:05	6.6	5:50	10.4	8.7	5:05	0.141	20:45	0.633	0.311	0.311	0.02
3/28/2018	0:45	1.3	19:40	2.6	1.7	2:45	6.7	19:40	10.2	8.7	2:45	0.153	19:40	0.640	0.311	0.311	0.01
3/29/2018	4:15	1.3	6:15	2.6	1.7	3:10	6.6	6:15	10.2	8.6	4:15	0.152	6:15	0.648	0.310	0.310	0.00
3/30/2018	3:20	1.3	20:55	2.4	1.7	3:30	6.5	8:05	9.9	8.5	2:25	0.152	8:05	0.571	0.303	0.303	0.00
3/31/2018	4:20	1.3	10:25	2.5	1.7	3:15	6.6	7:45	10.0	8.6	4:20	0.149	7:45	0.603	0.312	0.312	0.00
ReportAvg					1.7					8.6					0.309		
ReportTotal															9.569	2.33	

ADS Environmental Services

Pipe Height: 8.00

Date	REN_MH0537\mp1\DFINAL (inches)					REN_MH0537\mp1\VFINAL (feet/sec)					REN_MH0537\mp1\QFINAL (MGD - Total MG)					REN_RG\mp1\RAIN (inches)	
	Time	Min.	Time	Max.	Average	Time	Min.	Time	Max.	Average	Time	Min.	Time	Max.	Average	Total	Total
4/1/2018	4:00	1.3	8:40	2.7	1.7	4:15	6.5	8:15	9.9	8.6	4:15	0.150	8:40	0.673	0.318	0.318	0.10
4/2/2018	4:00	1.3	7:35	2.4	1.7	2:55	6.4	7:35	10.0	8.6	4:00	0.158	7:35	0.584	0.304	0.304	0.00
4/3/2018	3:50	1.3	18:15	2.4	1.7	2:30	6.4	19:15	10.0	8.5	3:50	0.155	18:15	0.582	0.300	0.300	0.00
4/4/2018	1:20	1.3	18:00	2.5	1.7	2:25	6.6	20:30	10.0	8.6	1:20	0.156	18:00	0.586	0.302	0.302	0.39
4/5/2018	4:05	1.3	6:40	2.5	1.7	2:55	6.5	6:40	10.0	8.5	4:05	0.160	6:40	0.591	0.298	0.298	0.25
4/6/2018	2:00	1.3	8:15	2.5	1.6	3:00	6.7	7:20	10.0	8.6	2:00	0.155	8:15	0.604	0.294	0.294	0.00
4/7/2018	1:40	1.2	10:10	2.7	1.7	1:40	6.8	10:40	10.0	8.8	1:40	0.147	10:10	0.645	0.320	0.320	0.88
4/8/2018	1:50	1.3	10:45	2.6	1.7	2:45	6.9	18:55	9.9	8.7	2:45	0.162	9:10	0.627	0.316	0.316	0.45
4/9/2018	2:50	1.3	18:50	2.5	1.7	2:45	6.8	18:50	10.2	8.7	2:45	0.161	18:50	0.616	0.311	0.311	0.00
4/10/2018	5:20	1.3	22:10	2.6	1.6	2:35	6.8	17:20	10.3	8.5	2:50	0.159	22:10	0.628	0.295	0.295	0.23
4/11/2018	5:05	1.3	19:10	2.5	1.7	2:25	6.7	6:50	10.2	8.7	2:25	0.158	19:10	0.609	0.311	0.311	0.31
4/12/2018	4:40	1.3	6:40	2.5	1.7	2:10	7.0	6:45	10.2	8.7	4:40	0.164	6:40	0.606	0.303	0.303	0.11
4/13/2018	4:15	1.3	14:45	2.6	1.7	1:40	6.8	14:45	10.2	8.8	1:45	0.166	14:45	0.651	0.311	0.311	0.51
4/14/2018	4:25	1.3	19:50	2.8	1.7	23:35	7.2	22:25	10.5	8.9	23:35	0.171	19:50	0.712	0.325	0.325	1.52
4/15/2018	18:40	1.4	14:00	2.7	1.7	18:40	7.8	21:30	10.4	9.0	18:40	0.213	21:30	0.688	0.330	0.330	0.21
4/16/2018	6:30	1.4	19:45	2.6	1.8	6:30	7.5	6:50	10.4	9.2	6:30	0.189	19:45	0.652	0.357	0.357	0.71
4/17/2018	19:40	1.3	6:05	2.7	1.8	19:40	7.0	6:45	10.4	9.1	19:40	0.162	6:45	0.700	0.341	0.341	0.01
4/18/2018	20:15	1.3	8:00	2.6	1.7	20:15	7.1	19:30	10.4	9.0	20:15	0.166	8:00	0.660	0.332	0.332	0.12
4/19/2018	20:45	1.3	6:30	2.5	1.7	20:45	7.2	6:30	10.5	9.0	20:45	0.173	6:30	0.652	0.330	0.330	0.00
4/20/2018	3:15	1.3	8:30	2.4	1.7	1:20	7.5	6:55	10.5	9.1	1:20	0.186	8:30	0.599	0.333	0.333	0.00
4/21/2018	12:00	1.2	8:20	2.5	1.7	12:00	6.7	7:05	10.4	9.0	12:00	0.146	8:20	0.635	0.322	0.322	0.05
4/22/2018	13:25	1.3	12:40	2.6	1.7	13:25	6.9	8:50	10.3	8.8	13:25	0.159	12:40	0.623	0.313	0.313	0.00
ReportAvg	1.7					8.8					0.317						
ReportTotal																6.964	5.85

REN_MH1360

Located At: Intersection of Ferndale and 7th St (see attached site report for details)
Monitoring Period: December 22, 2017 – April 22, 2018
Pipe Dimensions: 10.75"
Finalized Silt Level: 0 mm

Site Data Characteristics: This site is located in a sanitary sewer pipe. The scattergraph indicates site operated in free flow conditions. The site did not surcharge during the monitoring period. The dry weather data plots above the Froude =1 curve indicating supercritical flow.

Site Data Bias & Editing: The depth and velocity measurements recorded by the flow monitor were consistent with field confirmations conducted to date and supported the relative accuracy of the flow monitor at this location. The finalized depth data utilized the upward ultrasonic sensor.

Site Data Uptime: The data uptime achieved during the monitoring period is provided in the table below. Based upon the quality and consistency of the observed flow depth and velocity data, the Continuity equation was used to calculate the flow rate for the monitoring period.

Entity	Percentage Uptime Raw	Percentage Uptime Final
Depth (in)	100%	98%
Velocity (f/s)	100%	98%
Quantity (mgd)	100%	98%

Site Data Summary: The average flow depth, velocity, and quantity data observed during the monitoring period along with observed minimum and maximum data, are provided in the following table. The minimum and maximum rates recorded in the tables are based on 5-minute data intervals.

Item	Depth (in)	Velocity (f/s)	Quantity (mgd)	% Full
Minimum	1.49	2.26	0.082	14%
Maximum	5.28	5.41	1.013	49%
Average	2.75	3.86	0.338	26%

Renton.Carollo.I&I.WA17

Flow Monitoring Site Report



Site Name

REN_MH1360

Site Address /Location:	Intersection of Ferndale PI NE and NE 7th St		Monitor Series	Location Type
Site Access Details:	Located in roadway, at intersection. Requires traffic control.	Latitude:	TRITON+	Temporary
		Longitude:	Pipe Size (H x W)	Pipe Shape
			10.75" x 10.75"	Circular

Manhole #	System Characteristics
MH1360	Other
Access	Traffic
Drive	Medium

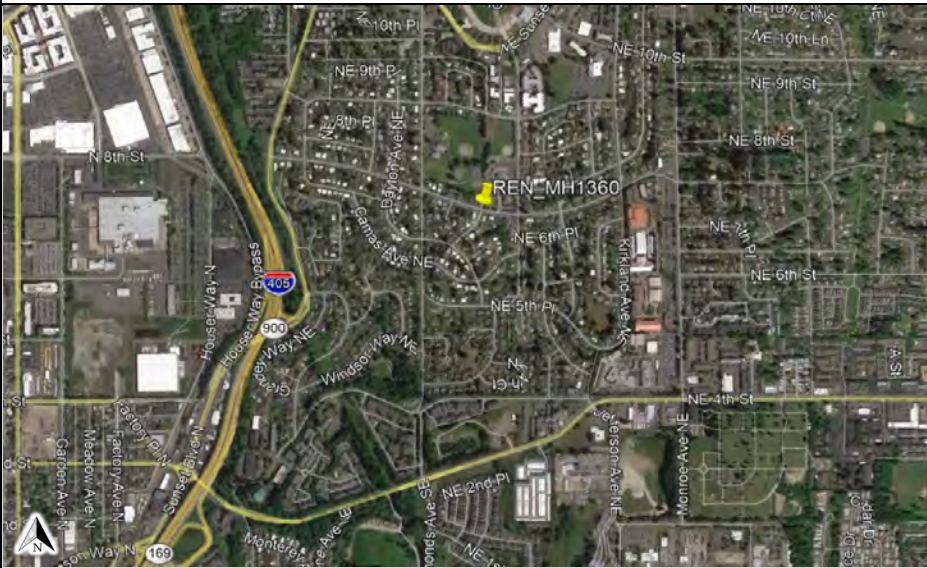

Installation Information

Installation Date:	Installation Type:
12.13.17	Doppler Standard Ring and Crank
Monitoring Location (Sensors):	Monitor Location:
Upstream 0-5 FT	Manhole
Sensors / Devices:	Pressure Sensor Range (psi)
Peak Combo (CS4), Smart Depth (CS5)	0 - 5 psi

Installation Confirmation:

Confirmation Time:	Pipe Size (HxW)
9:20:00 AM	10.75" x 10.75"
Depth of Flow (Wet DOF) (in)	Range (Air DOF) (in)
~2.00"	
Downlooker Physical Offset (in)	Measurement Confidence (in)
1.25"	0.25"
Peak Velocity (fps)	Velocity Sensor Offset (in)
2.5 FPS	
Silt (in)	Silt Type
0	

Hydraulic Comments:
Low, fast flow

Manhole / Pipe Information:

Manhole Depth (Approx. FT):	Manhole Configuration
~8'	Single
Manhole Material:	Manhole Condition:
Concrete	Good
Manhole Opening Diameter (in)	Manhole Diameter (Approx.):
20"	20"
Manhole Cover	Manhole Frame
Unbolted	Normal
Active Drop Connections	Air Quality:
No	Normal
Pipe Material	Pipe Condition:
Concrete	Good

Communication Information:

Communication Type	Antenna Location
Wireless	Manhole Pick / Vent Hole

Additional Site Info. / Comments:

Site located in roadway. Traffic control required.



ADS Project Name: Renton.Carollo.I&I.WA17

ADS Project Number: 22275.11.325

Additional Photos

Upstream



Downstream



Overflow

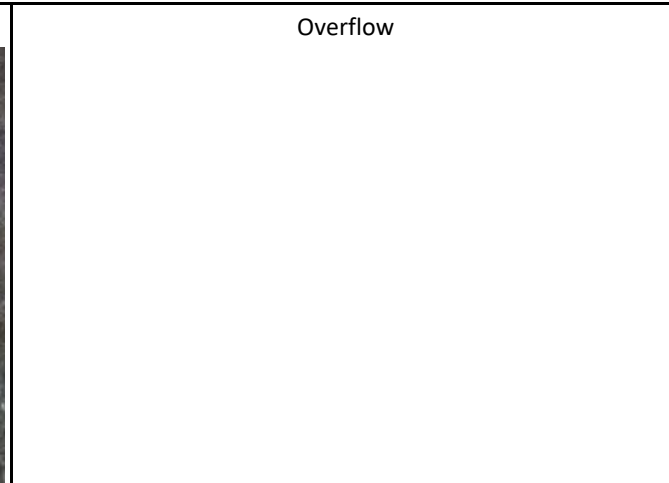

Top Down



Location



Location

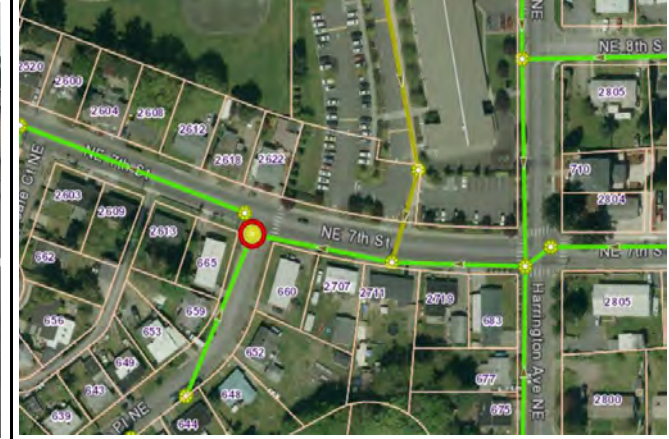

- Flow Direction
- ⊗ Monitoring Point

HYDROGRAPH REPORT

REN_MH1360

Flow Monitor
REN_MH1360

Pipe Height
10.75 in

Report Period
12/22/2017
To
4/22/2018

Legend
— Depth
— Velocity
— Rain

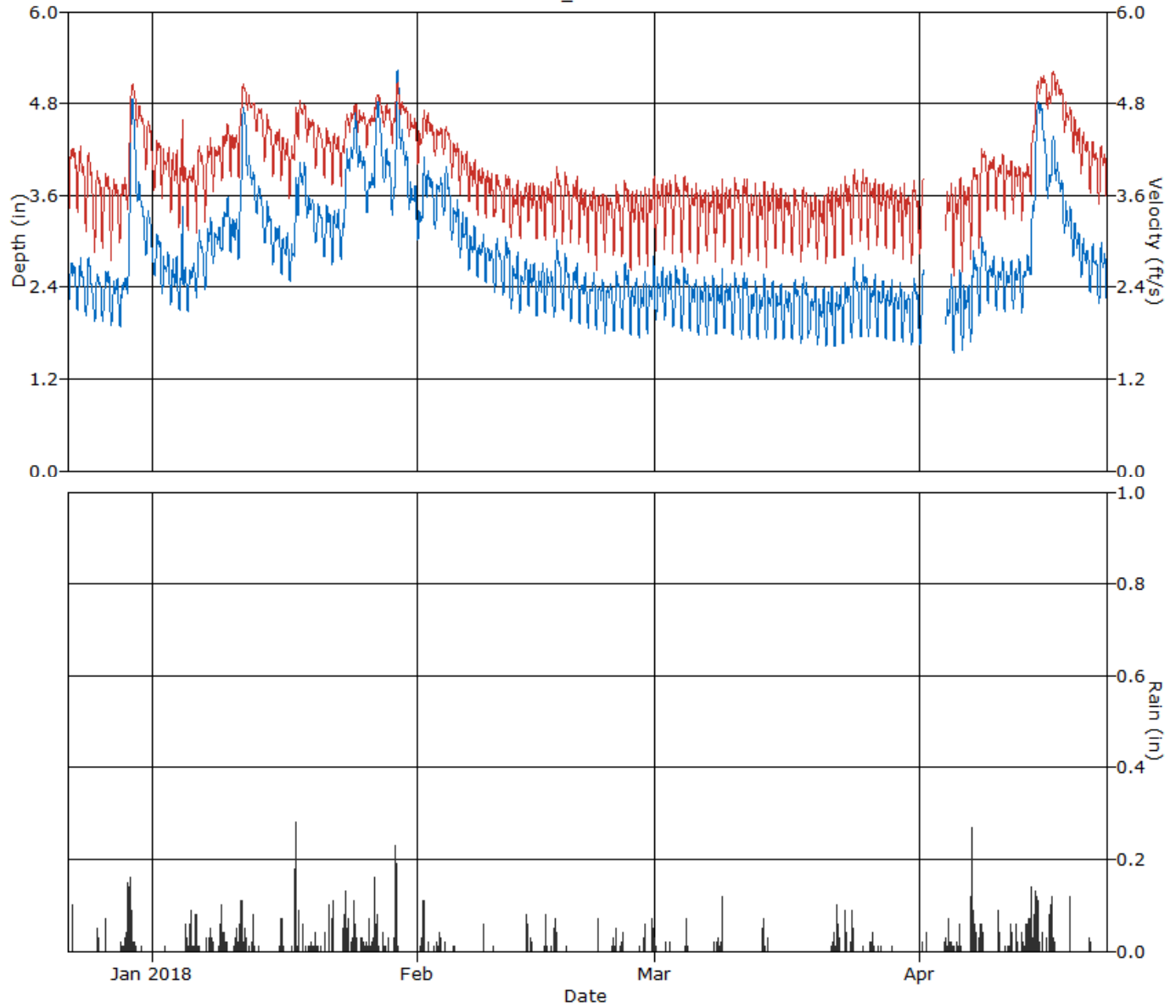

HYDROGRAPH REPORT

REN_MH1360

Flow Monitor
REN_MH1360

Pipe Height
10.75 in.

Report Period
12/22/2017
To
4/22/2018

Legend
— Quantity
— Rain

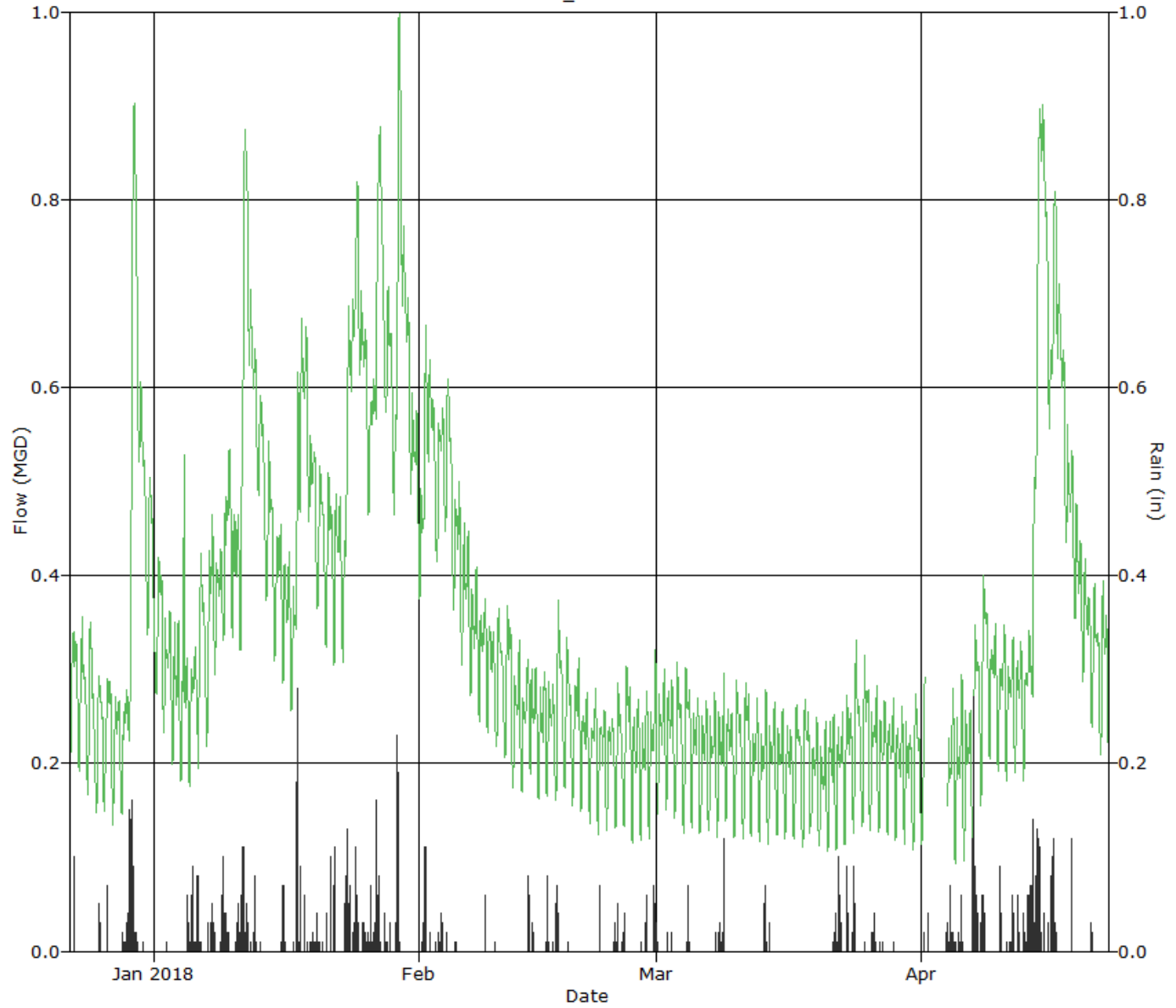

SCATTERGRAPH REPORT

REN_MH1360

Flow Monitor
REN_MH1360

Pipe Height
10.75 in

Report Period
12/22/2017
To
4/22/2018

Legend
○ Depth - Velocity
- Iso-Q™
- Silt
▼ Min-Max Depth

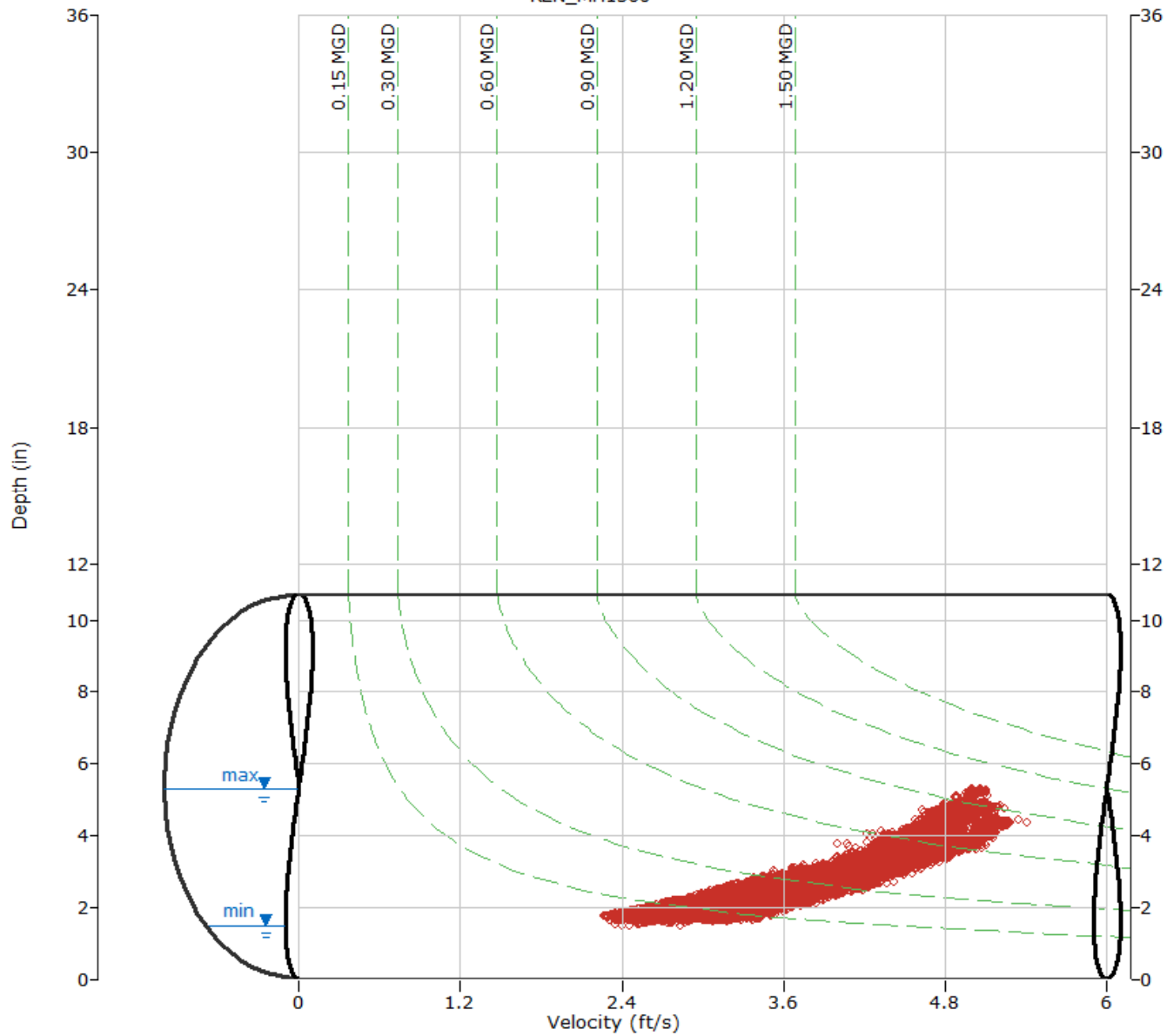

ADS Environmental Services

Pipe Height: 10.75

Date	REN_MH1360\mp1\DFINAL (inches)					REN_MH1360\mp1\VFINAL (feet/sec)					REN_MH1360\mp1\QFINAL (MGD - Total MG)						REN_RG\mp1\RAIN (inches)	
	Time	Min.	Time	Max.	Average	Time	Min.	Time	Max.	Average	Time	Min.	Time	Max.	Average	Total	Total	
12/22/2017	3:40	2.2	12:00	2.8	2.5	3:40	2.9	12:00	4.3	4.0	3:40	0.170	12:00	0.365	0.293	0.293	0.10	
12/23/2017	4:45	2.1	12:35	2.9	2.4	2:50	2.9	9:45	4.3	3.9	2:50	0.167	12:35	0.391	0.274	0.274	0.00	
12/24/2017	4:30	2.0	15:25	3.0	2.4	3:40	2.7	11:25	4.2	3.7	4:35	0.144	11:25	0.366	0.257	0.257	0.00	
12/25/2017	5:05	1.9	14:30	2.8	2.3	4:40	2.6	14:30	4.1	3.6	5:15	0.131	14:30	0.340	0.234	0.234	0.14	
12/26/2017	2:55	1.9	18:15	2.7	2.3	2:50	2.6	12:45	4.1	3.6	2:50	0.128	18:15	0.317	0.237	0.237	0.17	
12/27/2017	4:15	1.9	20:20	2.7	2.3	3:55	2.5	18:20	4.0	3.5	3:55	0.120	20:20	0.308	0.223	0.223	0.00	
12/28/2017	4:10	1.9	18:40	2.6	2.3	2:30	2.5	18:25	4.0	3.5	4:15	0.122	18:25	0.293	0.228	0.228	0.25	
12/29/2017	0:40	2.2	15:15	4.9	3.9	0:35	3.0	15:00	5.1	4.5	0:35	0.190	15:05	0.924	0.635	0.635	1.57	
12/30/2017	23:55	3.2	0:00	4.0	3.6	3:00	4.3	0:20	4.9	4.6	23:55	0.447	0:30	0.663	0.547	0.547	0.02	
12/31/2017	5:20	2.8	10:45	3.4	3.1	5:50	3.7	14:15	4.7	4.3	5:50	0.316	11:55	0.525	0.423	0.423	0.00	
ReportAvg	2.7					3.9					0.335							
ReportTotal																	3.351	2.25

ADS Environmental Services

Pipe Height: 10.75

Date	REN_MH1360\mp1\DFINAL (inches)					REN_MH1360\mp1\VFINAL (feet/sec)					REN_MH1360\mp1\QFINAL (MGD - Total MG)					REN_RG\mp1\RAIN (inches)	
	Time	Min.	Time	Max.	Average	Time	Min.	Time	Max.	Average	Time	Min.	Time	Max.	Average	Total	Total
1/1/2018	23:55	2.5	13:10	3.2	2.8	4:25	3.3	13:10	4.4	4.1	4:25	0.248	13:10	0.452	0.351	0.351	0.00
1/2/2018	3:35	2.3	19:30	2.9	2.6	2:20	3.3	21:55	4.3	4.0	3:55	0.214	19:30	0.383	0.307	0.307	0.01
1/3/2018	3:50	2.2	10:50	3.3	2.5	3:30	2.9	10:50	4.6	3.9	3:30	0.172	10:50	0.485	0.284	0.284	0.00
1/4/2018	2:55	2.1	11:40	3.8	2.5	3:20	2.7	11:40	4.9	3.8	3:20	0.153	11:40	0.630	0.285	0.285	0.09
1/5/2018	3:20	2.1	20:05	2.8	2.5	3:55	2.8	12:45	4.1	3.7	3:55	0.155	20:05	0.334	0.265	0.265	0.42
1/6/2018	3:00	2.3	11:55	3.2	2.8	4:00	2.9	10:15	4.3	3.9	4:00	0.181	11:55	0.442	0.329	0.329	0.24
1/7/2018	4:45	2.4	19:25	3.4	2.9	3:55	3.0	19:10	4.5	3.9	3:55	0.199	19:25	0.492	0.352	0.352	0.38
1/8/2018	4:10	2.7	19:15	3.3	3.0	4:00	3.3	20:15	4.4	4.1	4:00	0.267	19:10	0.445	0.380	0.380	0.14
1/9/2018	0:05	2.9	10:15	4.0	3.3	3:25	3.5	10:15	4.8	4.3	3:25	0.305	10:15	0.667	0.446	0.446	0.46
1/10/2018	10:50	2.8	14:10	3.8	3.1	3:25	3.7	14:10	4.7	4.2	3:25	0.319	14:10	0.596	0.414	0.414	0.22
1/11/2018	1:50	2.8	14:15	4.8	3.9	2:05	3.7	14:10	5.2	4.7	2:05	0.305	14:10	0.900	0.645	0.645	1.04
1/12/2018	23:55	3.6	0:00	4.2	3.9	23:35	4.6	7:30	5.0	4.8	23:50	0.562	7:50	0.716	0.640	0.640	0.20
1/13/2018	23:55	3.3	11:20	3.8	3.5	6:05	4.2	13:10	4.8	4.6	6:05	0.461	11:20	0.606	0.536	0.536	0.02
1/14/2018	5:00	3.0	10:50	3.6	3.2	5:05	3.8	11:30	4.7	4.4	5:05	0.348	10:35	0.558	0.453	0.453	0.00
1/15/2018	3:35	2.7	19:45	3.3	3.0	2:40	3.5	13:45	4.5	4.2	2:40	0.280	19:45	0.465	0.396	0.396	0.04
1/16/2018	4:25	2.5	19:10	3.2	2.9	2:45	3.6	9:45	4.4	4.1	2:45	0.276	20:35	0.435	0.364	0.364	0.26
1/17/2018	3:15	2.4	21:15	3.9	3.0	1:55	3.3	21:05	4.8	4.2	3:30	0.236	21:05	0.636	0.394	0.394	0.79
1/18/2018	2:35	3.3	7:05	4.1	3.8	2:20	4.1	10:30	4.9	4.7	2:20	0.438	7:00	0.687	0.595	0.595	0.40
1/19/2018	23:55	3.2	8:20	3.7	3.5	3:40	4.1	6:40	4.7	4.5	23:55	0.426	8:20	0.574	0.509	0.509	0.10
1/20/2018	3:05	3.0	11:05	3.5	3.2	6:00	3.8	11:10	4.6	4.3	6:00	0.347	11:10	0.535	0.448	0.448	0.10
1/21/2018	5:35	2.8	11:50	3.5	3.1	4:00	3.6	10:35	4.6	4.2	4:00	0.306	11:50	0.523	0.421	0.421	0.16
1/22/2018	1:45	2.7	7:40	3.4	3.1	3:10	3.5	19:00	4.5	4.2	3:10	0.285	7:40	0.501	0.415	0.415	0.34
1/23/2018	3:05	2.7	20:25	4.3	3.4	2:55	3.5	19:25	4.8	4.3	2:55	0.287	19:25	0.717	0.484	0.484	0.79
1/24/2018	4:15	3.9	20:50	4.7	4.3	3:30	4.3	21:50	4.8	4.6	3:30	0.576	20:25	0.830	0.700	0.700	0.51
1/25/2018	23:55	3.7	7:35	4.3	4.0	2:00	4.2	9:05	4.9	4.6	23:50	0.553	9:05	0.729	0.646	0.646	0.14
1/26/2018	3:55	3.4	18:55	3.9	3.7	4:55	4.1	17:15	4.7	4.5	4:55	0.444	19:35	0.628	0.559	0.559	0.36
1/27/2018	0:15	3.7	12:15	4.9	4.4	0:25	4.5	10:45	5.0	4.8	0:25	0.555	11:15	0.893	0.759	0.759	0.61
1/28/2018	23:55	3.6	11:45	4.3	3.9	4:25	4.4	10:30	4.8	4.6	23:55	0.542	11:45	0.723	0.631	0.631	0.07
1/29/2018	3:55	3.3	19:15	5.3	4.2	3:05	4.1	16:35	5.1	4.7	3:05	0.443	18:35	1.013	0.699	0.699	0.90
1/30/2018	23:55	3.7	0:00	4.6	4.2	23:40	4.6	5:30	4.9	4.7	23:45	0.573	0:00	0.808	0.693	0.693	0.00
1/31/2018	23:50	3.3	7:40	3.8	3.6	3:35	4.1	17:40	4.7	4.5	23:45	0.450	7:40	0.607	0.538	0.538	0.00
ReportAvg	3.4					4.3					0.482						
ReportTotal																14.94	8.79

ADS Environmental Services

Pipe Height: 10.75

Date	REN_MH1360\mp1\DFINAL (inches)					REN_MH1360\mp1\VFINAL (feet/sec)					REN_MH1360\mp1\QFINAL (MGD - Total MG)					REN_RG\mp1\RAIN (inches)	
	Time	Min.	Time	Max.	Average	Time	Min.	Time	Max.	Average	Time	Min.	Time	Max.	Average	Total	Total
2/1/2018	3:15	3.0	21:40	4.1	3.4	3:50	3.8	21:45	4.8	4.4	3:50	0.357	21:45	0.687	0.490	0.490	0.66
2/2/2018	23:45	3.5	8:00	4.0	3.7	16:30	4.0	8:05	4.7	4.5	23:55	0.500	8:05	0.642	0.570	0.570	0.04
2/3/2018	3:30	3.1	20:25	3.9	3.6	5:40	4.0	10:05	4.6	4.3	5:40	0.402	19:55	0.588	0.513	0.513	0.31
2/4/2018	23:55	3.3	12:05	4.0	3.6	4:55	4.0	11:40	4.7	4.3	4:55	0.433	12:05	0.646	0.528	0.528	0.02
2/5/2018	3:15	3.0	19:00	3.6	3.3	3:10	3.5	10:10	4.4	4.1	3:10	0.330	19:05	0.522	0.440	0.440	0.04
2/6/2018	3:40	2.8	10:35	3.8	3.1	3:25	3.4	10:40	4.3	4.0	3:25	0.286	10:40	0.558	0.388	0.388	0.00
2/7/2018	3:10	2.6	21:05	3.3	2.9	3:15	3.2	20:10	4.2	3.8	3:15	0.246	20:55	0.433	0.343	0.343	0.00
2/8/2018	3:45	2.5	20:40	3.2	2.8	2:45	3.2	9:05	4.1	3.8	3:35	0.232	20:40	0.403	0.324	0.324	0.09
2/9/2018	4:05	2.4	10:15	3.0	2.7	3:20	3.1	18:20	4.0	3.6	3:20	0.214	7:35	0.364	0.301	0.301	0.01
2/10/2018	4:35	2.3	11:00	3.1	2.7	4:20	3.0	11:15	4.0	3.6	4:20	0.196	11:15	0.392	0.293	0.293	0.01
2/11/2018	5:00	2.3	12:05	3.1	2.7	5:15	2.9	11:45	4.0	3.6	5:15	0.186	11:50	0.386	0.293	0.293	0.00
2/12/2018	3:30	2.1	20:20	2.9	2.5	2:10	2.7	20:25	3.9	3.5	3:35	0.157	20:20	0.351	0.253	0.253	0.00
2/13/2018	2:30	2.0	19:40	2.8	2.5	3:10	2.7	18:25	3.9	3.5	2:30	0.145	21:20	0.326	0.247	0.247	0.17
2/14/2018	4:25	2.1	19:30	2.8	2.5	3:10	2.9	6:40	3.9	3.5	3:10	0.170	19:15	0.314	0.251	0.251	0.15
2/15/2018	2:20	2.0	21:05	2.8	2.4	2:55	2.7	17:00	3.9	3.5	2:55	0.142	19:00	0.321	0.239	0.239	0.00
2/16/2018	2:15	2.0	19:55	2.7	2.4	1:10	2.7	19:45	3.9	3.5	3:40	0.150	19:50	0.316	0.238	0.238	0.15
2/17/2018	3:00	2.0	10:55	3.1	2.6	3:10	2.6	10:30	4.1	3.6	3:10	0.138	10:30	0.397	0.272	0.272	0.32
2/18/2018	4:10	2.1	10:45	3.0	2.5	4:10	2.7	10:35	4.1	3.5	4:10	0.150	10:35	0.370	0.254	0.254	0.01
2/19/2018	3:45	2.0	19:20	2.9	2.4	3:45	2.5	11:05	3.9	3.5	3:45	0.129	19:20	0.337	0.240	0.240	0.00
2/20/2018	2:50	1.9	19:35	2.7	2.3	2:45	2.5	19:10	4.0	3.5	2:45	0.119	19:10	0.298	0.223	0.223	0.00
2/21/2018	3:35	1.9	20:30	2.6	2.3	3:55	2.4	7:00	3.9	3.4	3:55	0.114	20:30	0.289	0.219	0.219	0.00
2/22/2018	3:50	1.8	19:10	2.6	2.3	3:15	2.4	20:40	3.8	3.4	3:15	0.111	19:10	0.282	0.212	0.212	0.07
2/23/2018	2:15	1.8	17:45	2.5	2.2	4:05	2.5	17:40	3.8	3.4	4:05	0.110	17:40	0.271	0.208	0.208	0.01
2/24/2018	4:30	1.8	10:40	2.7	2.3	3:55	2.4	10:35	3.8	3.4	3:50	0.109	10:35	0.307	0.212	0.212	0.13
2/25/2018	3:55	1.8	11:25	2.7	2.3	4:40	2.5	9:50	3.9	3.4	4:40	0.114	10:20	0.315	0.226	0.226	0.11
2/26/2018	3:20	1.8	19:00	2.6	2.2	3:40	2.3	19:45	3.9	3.3	3:40	0.100	19:45	0.285	0.203	0.203	0.00
2/27/2018	3:15	1.7	19:50	2.6	2.2	2:25	2.3	18:10	3.9	3.3	2:25	0.099	19:50	0.294	0.204	0.204	0.19
2/28/2018	3:10	1.8	19:15	2.9	2.3	3:55	2.3	21:00	4.0	3.4	3:50	0.105	19:15	0.336	0.222	0.222	0.35
ReportAvg	2.7					3.7					0.300						
ReportTotal																8.405	2.84

ADS Environmental Services

Pipe Height: 10.75

Date	REN_MH1360\mp1\DFINAL (inches)					REN_MH1360\mp1\VFINAL (feet/sec)					REN_MH1360\mp1\QFINAL (MGD - Total MG)						REN_RG\mp1\RAIN (inches)		
	Time	Min.	Time	Max.	Average	Time	Min.	Time	Max.	Average	Time	Min.	Time	Max.	Average	Total	Total		
3/1/2018	4:10	1.9	21:10	2.7	2.4	2:35	2.6	20:45	4.0	3.5	2:35	0.130	20:45	0.314	0.234	0.234	0.01		
3/2/2018	1:40	1.9	20:00	2.7	2.3	1:30	2.6	18:45	4.0	3.5	1:30	0.133	20:00	0.309	0.232	0.232	0.07		
3/3/2018	3:55	1.9	10:40	2.8	2.3	2:25	2.6	10:40	4.1	3.5	3:20	0.128	10:40	0.341	0.231	0.231	0.00		
3/4/2018	4:45	1.8	10:25	2.8	2.3	4:50	2.4	10:30	4.0	3.5	4:50	0.107	10:30	0.326	0.228	0.228	0.12		
3/5/2018	4:05	1.8	21:15	2.6	2.2	2:50	2.4	21:40	3.9	3.4	2:50	0.110	21:15	0.284	0.214	0.214	0.00		
3/6/2018	3:05	1.8	21:05	2.6	2.2	1:45	2.3	21:05	3.9	3.4	1:45	0.105	21:05	0.293	0.209	0.209	0.00		
3/7/2018	3:15	1.8	19:15	2.6	2.2	4:00	2.4	7:35	3.9	3.4	4:00	0.108	19:50	0.285	0.207	0.207	0.03		
3/8/2018	4:10	1.8	21:15	2.7	2.2	2:20	2.3	22:00	3.9	3.4	2:20	0.104	21:15	0.301	0.209	0.209	0.37		
3/9/2018	3:35	1.8	7:40	2.5	2.2	2:45	2.5	19:00	3.9	3.5	2:45	0.117	7:40	0.281	0.214	0.214	0.00		
3/10/2018	3:55	1.8	9:40	2.6	2.2	3:05	2.3	10:25	3.9	3.5	4:05	0.102	10:35	0.295	0.214	0.214	0.00		
3/11/2018	4:45	1.7	11:50	2.6	2.2	3:15	2.3	18:45	4.0	3.4	4:45	0.099	11:30	0.295	0.215	0.215	0.00		
3/12/2018	3:10	1.7	19:05	2.6	2.2	2:50	2.4	19:55	3.9	3.4	2:50	0.100	19:05	0.289	0.200	0.200	0.00		
3/13/2018	2:20	1.7	18:55	2.7	2.2	2:05	2.3	17:35	3.9	3.4	2:05	0.097	20:10	0.297	0.201	0.201	0.31		
3/14/2018	1:35	1.7	19:55	2.6	2.2	2:00	2.3	20:35	3.9	3.4	2:00	0.096	19:55	0.285	0.200	0.200	0.04		
3/15/2018	1:30	1.7	19:45	2.5	2.1	1:30	2.4	19:45	3.9	3.4	1:30	0.100	19:45	0.279	0.200	0.200	0.00		
3/16/2018	1:10	1.7	17:35	2.4	2.1	1:25	2.5	7:40	3.8	3.4	1:25	0.106	17:35	0.254	0.194	0.194	0.00		
3/17/2018	3:10	1.7	11:05	2.7	2.2	3:00	2.5	10:50	3.8	3.3	3:00	0.104	11:05	0.295	0.198	0.198	0.00		
3/18/2018	3:45	1.7	10:25	2.6	2.2	4:25	2.4	10:25	3.9	3.3	4:25	0.097	10:25	0.298	0.198	0.198	0.00		
3/19/2018	0:25	1.7	19:25	2.5	2.1	23:50	2.5	20:25	3.8	3.4	23:50	0.110	19:25	0.273	0.192	0.192	0.00		
3/20/2018	2:55	1.6	20:05	2.5	2.0	2:05	2.4	20:40	3.8	3.3	2:05	0.095	20:05	0.273	0.180	0.180	0.00		
3/21/2018	3:05	1.6	13:00	2.7	2.1	3:45	2.4	9:55	4.0	3.4	1:20	0.093	13:00	0.324	0.191	0.191	0.10		
3/22/2018	1:50	1.6	6:35	2.5	2.1	2:45	2.3	6:35	3.9	3.4	2:45	0.091	6:35	0.278	0.192	0.192	0.48		
3/23/2018	2:55	1.7	17:55	2.5	2.2	3:15	2.5	9:20	4.0	3.5	3:15	0.099	9:40	0.288	0.207	0.207	0.31		
3/24/2018	2:45	1.7	9:25	2.8	2.3	2:35	2.5	10:05	4.1	3.6	2:35	0.106	9:30	0.343	0.227	0.227	0.28		
3/25/2018	4:20	1.7	9:25	2.8	2.3	2:40	2.5	9:30	4.1	3.6	2:40	0.110	9:25	0.341	0.229	0.229	0.01		
3/26/2018	2:40	1.7	20:40	2.6	2.2	3:45	2.5	6:25	4.0	3.5	3:45	0.112	20:40	0.297	0.214	0.214	0.17		
3/27/2018	3:15	1.7	19:45	2.5	2.2	3:30	2.6	18:25	4.0	3.5	3:30	0.110	21:00	0.287	0.209	0.209	0.02		
3/28/2018	3:00	1.7	19:30	2.6	2.2	1:50	2.5	20:25	3.9	3.5	1:50	0.107	19:15	0.286	0.206	0.206	0.01		
3/29/2018	3:05	1.7	19:55	2.6	2.1	3:10	2.4	18:10	4.0	3.4	3:10	0.098	19:55	0.280	0.197	0.197	0.00		
3/30/2018	2:45	1.7	18:05	2.4	2.1	3:15	2.5	7:00	3.9	3.4	2:20	0.102	18:05	0.259	0.191	0.191	0.00		
3/31/2018	2:55	1.6	11:15	2.7	2.1	2:55	2.3	11:15	3.9	3.4	2:55	0.090	11:15	0.306	0.200	0.200	0.00		
ReportAvg					2.2					3.4							0.208		
ReportTotal																	6.433	2.33	

ADS Environmental Services

Pipe Height: 10.75

Date	REN_MH1360\mp1\DFINAL (inches)					REN_MH1360\mp1\VFINAL (feet/sec)					REN_MH1360\mp1\QFINAL (MGD - Total MG)					REN_RG\mp1\RAIN (inches)	
	Time	Min.	Time	Max.	Average	Time	Min.	Time	Max.	Average	Time	Min.	Time	Max.	Average	Total	Total
4/1/2018	2:40	1.6	11:10	2.7	2.0	3:20	2.5	11:10	4.0	3.3	2:45	0.101	11:10	0.321	0.186	0.094	0.10
4/2/2018																--	0.00
4/3/2018																--	0.00
4/4/2018	23:50	1.6	20:15	2.7	2.2	23:55	2.7	18:50	4.0	3.5	23:55	0.104	20:15	0.304	0.206	0.171	0.39
4/5/2018	1:10	1.5	19:15	2.7	2.1	1:20	2.4	19:10	4.0	3.3	1:10	0.082	19:15	0.316	0.196	0.196	0.25
4/6/2018	3:05	1.6	6:50	2.6	2.1	3:05	2.6	6:50	3.9	3.4	3:05	0.093	6:50	0.291	0.199	0.199	0.00
4/7/2018	1:15	1.7	9:50	3.0	2.4	1:15	2.7	11:40	4.1	3.7	1:15	0.110	9:50	0.373	0.263	0.263	0.88
4/8/2018	2:45	2.0	11:00	3.1	2.7	2:25	2.6	17:35	4.6	3.9	2:25	0.141	10:25	0.415	0.307	0.307	0.45
4/9/2018	3:05	2.2	20:20	2.9	2.5	2:20	3.1	18:05	4.2	3.9	2:20	0.188	18:05	0.369	0.290	0.290	0.00
4/10/2018	3:15	2.0	20:25	2.9	2.5	1:30	3.0	20:30	4.3	3.9	1:55	0.168	20:30	0.375	0.276	0.276	0.23
4/11/2018	1:30	2.0	21:30	2.8	2.5	1:05	2.9	21:15	4.2	3.8	1:05	0.162	21:15	0.349	0.271	0.271	0.31
4/12/2018	2:10	2.1	19:45	2.8	2.5	2:20	3.0	11:55	4.4	3.8	2:20	0.166	11:55	0.352	0.273	0.273	0.11
4/13/2018	1:55	2.0	18:25	2.9	2.5	0:40	2.8	18:30	4.2	3.8	0:40	0.155	18:30	0.364	0.281	0.281	0.51
4/14/2018	2:35	2.5	23:45	4.8	3.6	3:50	3.4	19:40	5.1	4.4	3:50	0.253	22:30	0.894	0.550	0.550	1.52
4/15/2018	23:50	3.7	9:15	4.8	4.5	22:40	4.8	10:05	5.2	5.1	23:55	0.596	9:20	0.921	0.817	0.817	0.21
4/16/2018	3:45	3.5	18:15	4.4	4.0	3:20	4.6	18:55	5.4	5.0	3:20	0.539	18:15	0.844	0.678	0.678	0.71
4/17/2018	23:55	3.2	5:45	4.1	3.8	23:50	4.5	5:40	5.2	5.0	23:55	0.467	5:45	0.735	0.630	0.630	0.01
4/18/2018	23:55	2.9	6:40	3.6	3.3	3:05	4.1	6:50	4.9	4.6	23:55	0.374	6:50	0.574	0.487	0.487	0.12
4/19/2018	23:40	2.6	7:15	3.3	3.0	23:40	3.9	6:50	4.7	4.4	23:40	0.293	6:50	0.493	0.407	0.407	0.00
4/20/2018	23:55	2.5	6:50	3.1	2.8	2:05	3.6	7:25	4.5	4.2	2:05	0.270	6:50	0.431	0.353	0.353	0.00
4/21/2018	2:30	2.3	10:20	3.0	2.6	3:20	3.3	8:05	4.4	4.0	3:20	0.216	10:25	0.403	0.316	0.316	0.05
4/22/2018	23:50	2.2	9:05	3.1	2.6	4:40	3.1	9:10	4.3	3.9	4:05	0.189	9:10	0.409	0.302	0.302	0.00
ReportAvg	2.8					4.1					0.370						
ReportTotal																7.160	5.85

REN_MH1763

Located At: 3000 SE 5th St (see attached site report for details)
Monitoring Period: December 22, 2017 – April 22, 2018
Pipe Dimensions: 15"
Finalized Silt Level: 0 mm

Site Data Characteristics: This site is located in a sanitary sewer pipe. The scattergraph indicates site operated in free flow conditions. The site did surcharge during the monitoring period. The dry weather data plots below the Froude =1 curve indicating subcritical flow.

Site Data Bias & Editing: The depth and velocity measurements recorded by the flow monitor were consistent with field confirmations conducted to date and supported the relative accuracy of the flow monitor at this location. The finalized depth data utilized the pressure sensor.

Site Data Uptime: The data uptime achieved during the monitoring period is provided in the table below. Based upon the quality and consistency of the observed flow depth and velocity data, the Continuity equation was used to calculate the flow rate for the monitoring period.

Entity	Percentage Uptime Raw	Percentage Uptime Final
Depth (in)	100%	98%
Velocity (f/s)	100%	98%
Quantity (mgd)	100%	98%

Site Data Summary: The average flow depth, velocity, and quantity data observed during the monitoring period along with observed minimum and maximum data, are provided in the following table. The minimum and maximum rates recorded in the tables are based on 5-minute data intervals.

Item	Depth (in)	Velocity (f/s)	Quantity (mgd)	% Full
Minimum	4.06	0.17	0.035	27%
Maximum	17.41	0.95	0.749	100%
Average	9.59	0.47	0.257	64%

Renton.Carollo.I&I.WA17

Flow Monitoring Site Report



Site Name

REN_MH1763

Site Address /Location:	3000 SE 5th St		
Site Access Details:	Located in roadway, at intersection. Requires traffic control.	Latitude:	47.477311°
		Longitude:	-122.179048°

Monitor Series	TRITON+	Location Type	Temporary
Pipe Size (H x W)	15.00" x 15.00"	Pipe Shape	Circular

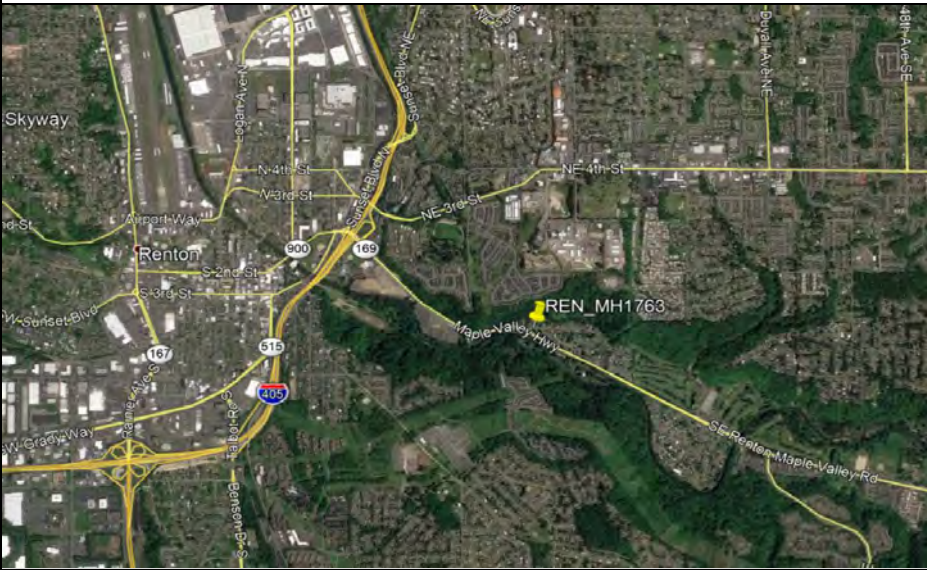

Manhole #	MH1763	System Characteristics	Residential
Access	Drive		Traffic
			Medium



Installation Information

Installation Date:	12.13.17	Installation Type:	Doppler Standard Ring and Crank
Monitoring Location (Sensors):	Upstream 0-5 FT	Monitor Location:	Manhole
Sensors / Devices:	Peak Combo (CS4), Smart Depth (CS5)	Pressure Sensor Range (psi)	0 - 5 psi

Installation Confirmation:

Confirmation Time:	3:17:00 PM	Pipe Size (HxW)	15.00" x 15.00"
Depth of Flow (Wet DOF) (in)	~8.00"	Range (Air DOF) (in)	
Downlooker Physical Offset (in)	1.25"	Measurement Confidence (in)	0.25"
Peak Velocity (fps)	.3 FPS	Velocity Sensor Offset (in)	
Silt (in)	0	Silt Type	

Hydraulic Comments:
Moderate, slow flow

Manhole / Pipe Information:

Manhole Depth (Approx. FT):	~8'	Manhole Configuration	Single
Manhole Material:	Concrete	Manhole Condition:	Good
Manhole Opening Diameter (in)	20"	Manhole Diameter (Approx.):	20"
Manhole Cover	Unbolted	Manhole Frame	Normal
Active Drop Connections	No	Air Quality:	Normal
Pipe Material	Concrete	Pipe Condition:	Good

Communication Information:

Communication Type	Wireless	Antenna Location	Manhole Pick / Vent Hole
--------------------	----------	------------------	--------------------------

Additional Site Info. / Comments:

Site located in roadway. Traffic control required.

ADS Project Name:	Renton.Carollo.I&I.WA17
ADS Project Number:	22275.11.325

HYDROGRAPH REPORT

REN_MH1763

Flow Monitor
REN_MH1763

Pipe Height
15.00 in

Report Period
12/22/2017
To
4/22/2018

Legend
— Depth
— Velocity

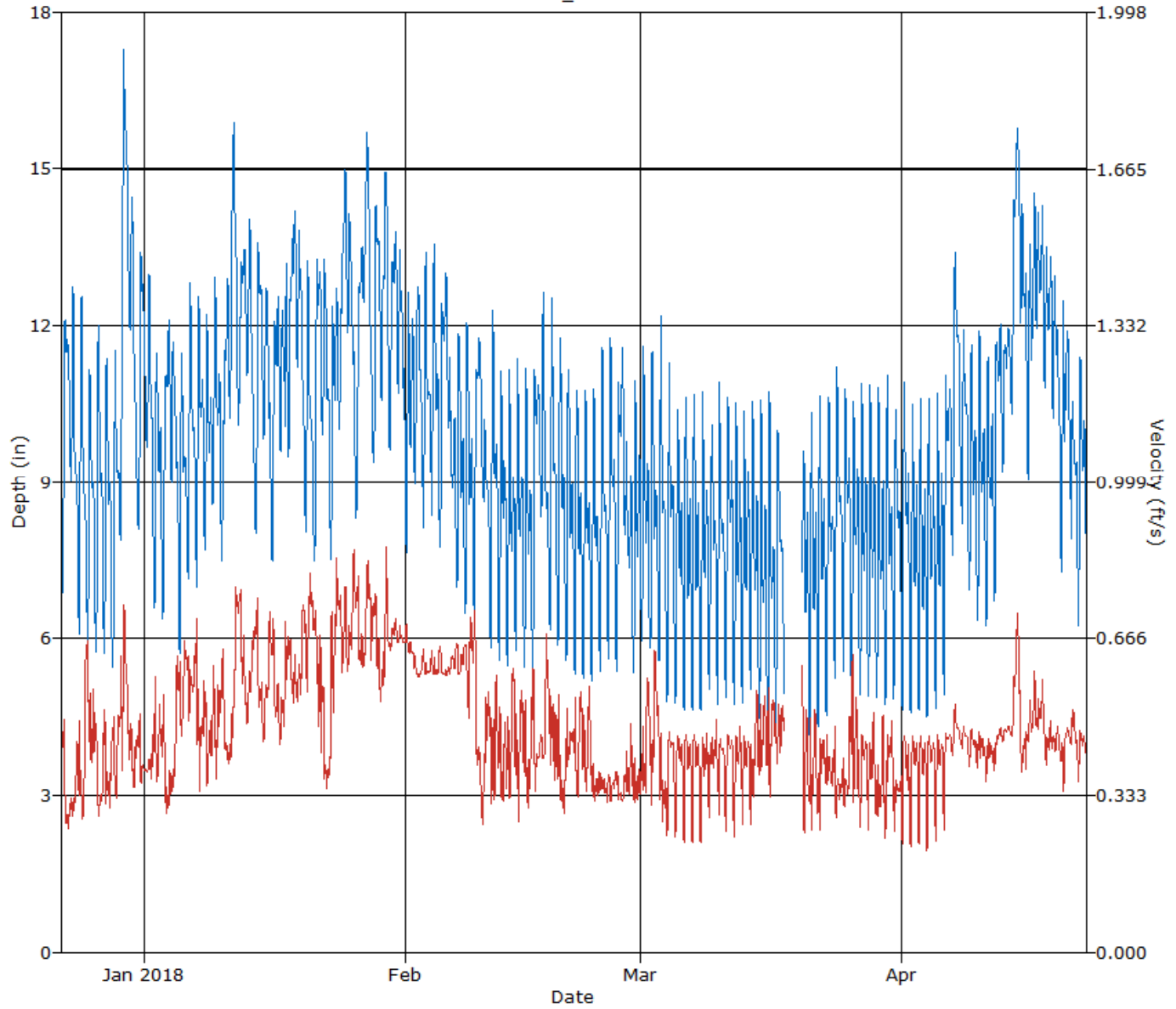

HYDROGRAPH REPORT

REN_MH1763

Flow Monitor
REN_MH1763

Pipe Height
15.00 in.

Report Period
12/22/2017
To
4/22/2018

Legend
Quantity

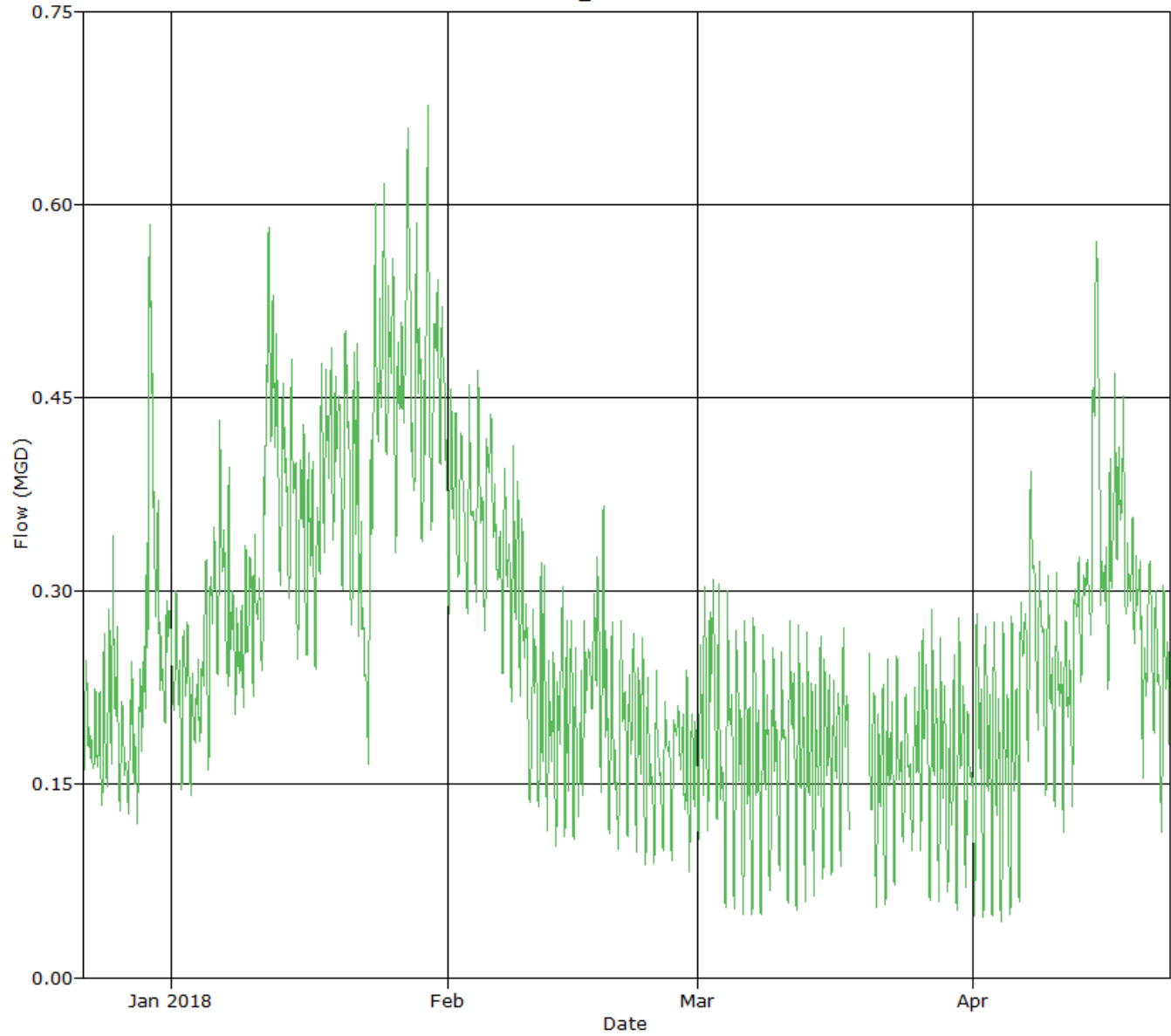

SCATTERGRAPH REPORT

REN_MH1763

Flow Monitor
REN_MH1763

Pipe Height
15.00 in

Report Period
12/22/2017
To
4/22/2018

Legend
○ Depth - Velocity
- - - Iso-Q™
- - - Silt
▼ Min-Max Depth

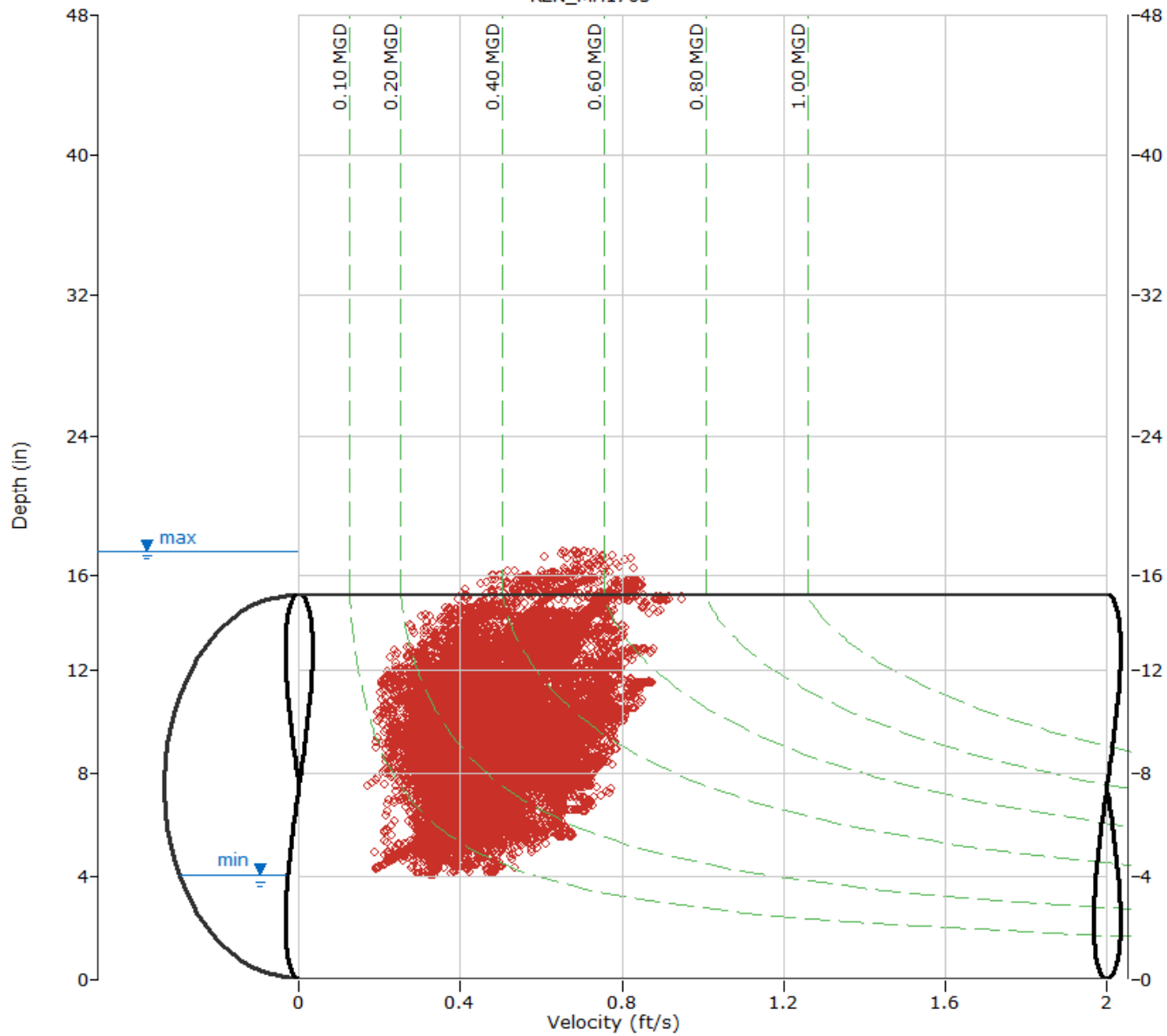

ADS Environmental Services

Pipe Height: 15.00

Date	REN_MH1763\mp1\DFINAL (inches)					REN_MH1763\mp1\VFINAL (feet/sec)					REN_MH1763\mp1\QFINAL (MGD - Total MG)					
	Time	Min.	Time	Max.	Average	Time	Min.	Time	Max.	Average	Time	Min.	Time	Max.	Average	Total
12/22/2017	4:10	6.8	11:45	12.3	10.0	16:40	0.2	8:10	0.6	0.4	22:30	0.133	11:45	0.305	0.193	0.193
12/23/2017	23:55	8.6	11:10	12.8	10.0	8:35	0.2	22:55	0.6	0.3	8:35	0.115	22:55	0.285	0.185	0.185
12/24/2017	5:05	6.0	11:50	12.7	9.1	15:00	0.2	22:15	0.7	0.4	4:55	0.090	11:55	0.355	0.188	0.188
12/25/2017	5:40	5.5	10:55	11.6	8.5	14:10	0.3	6:15	0.7	0.5	6:40	0.120	11:05	0.388	0.233	0.233
12/26/2017	4:55	5.7	12:20	12.1	8.8	14:10	0.2	3:00	0.6	0.4	7:20	0.098	9:40	0.241	0.171	0.171
12/27/2017	5:20	5.7	11:40	11.4	8.6	10:00	0.2	8:00	0.6	0.4	3:20	0.090	21:40	0.255	0.177	0.177
12/28/2017	4:25	5.4	11:40	11.6	8.5	11:50	0.2	21:55	0.6	0.4	5:25	0.094	12:25	0.305	0.195	0.195
12/29/2017	3:20	7.8	11:30	17.4	13.4	7:30	0.4	14:05	0.8	0.6	3:25	0.201	14:05	0.656	0.398	0.398
12/30/2017	23:55	10.1	11:40	14.6	12.5	14:35	0.3	0:15	0.6	0.4	22:50	0.168	0:15	0.444	0.298	0.298
12/31/2017	5:30	8.1	11:45	13.5	11.0	14:45	0.3	9:05	0.6	0.4	7:20	0.185	12:55	0.330	0.251	0.251
ReportAvg	10.1					0.4					0.229					
ReportTotal											2.290					

ADS Environmental Services

Pipe Height: 15.00

Date	REN_MH1763\mp1\DFINAL (inches)					REN_MH1763\mp1\VFINAL (feet/sec)					REN_MH1763\mp1\QFINAL (MGD - Total MG)					
	Time	Min.	Time	Max.	Average	Time	Min.	Time	Max.	Average	Time	Min.	Time	Max.	Average	Total
1/1/2018	23:55	8.8	12:25	13.1	10.9	20:00	0.3	23:10	0.6	0.4	23:45	0.169	12:25	0.303	0.241	0.241
1/2/2018	4:50	6.5	9:35	11.5	9.2	13:05	0.3	6:25	0.6	0.5	3:55	0.132	20:25	0.336	0.229	0.229
1/3/2018	5:05	6.3	21:20	12.2	9.8	15:05	0.2	5:55	0.6	0.4	5:15	0.128	23:25	0.303	0.201	0.201
1/4/2018	23:55	8.2	8:10	11.7	10.0	0:45	0.2	20:45	0.7	0.4	0:45	0.115	20:45	0.344	0.244	0.244
1/5/2018	4:50	5.7	9:35	11.5	8.9	10:30	0.4	19:55	0.7	0.6	4:05	0.151	19:30	0.357	0.275	0.275
1/6/2018	4:40	7.1	10:25	12.9	9.9	7:45	0.5	21:55	0.7	0.6	4:35	0.227	10:15	0.463	0.321	0.321
1/7/2018	5:30	6.8	10:30	12.7	10.0	11:30	0.3	4:40	0.7	0.5	11:30	0.203	10:40	0.454	0.282	0.282
1/8/2018	4:25	7.6	9:30	12.3	10.0	10:35	0.3	0:55	0.6	0.5	3:55	0.168	8:05	0.331	0.253	0.253
1/9/2018	1:35	8.5	8:30	13.0	10.4	12:20	0.3	6:00	0.6	0.5	0:00	0.175	7:45	0.370	0.285	0.285
1/10/2018	4:35	7.4	21:45	13.0	10.5	19:00	0.4	6:25	0.7	0.5	3:15	0.173	7:55	0.362	0.283	0.283
1/11/2018	4:35	10.2	14:40	16.0	13.2	1:15	0.3	19:45	0.8	0.5	5:40	0.184	19:45	0.612	0.394	0.394
1/12/2018	4:50	10.1	21:10	13.5	12.2	23:20	0.5	9:40	0.8	0.7	23:20	0.330	9:40	0.547	0.455	0.455
1/13/2018	23:50	10.0	10:40	14.1	12.0	1:20	0.5	23:10	0.7	0.6	6:15	0.294	11:05	0.492	0.384	0.384
1/14/2018	5:35	8.0	12:20	13.7	11.1	18:05	0.4	10:00	0.8	0.6	6:20	0.276	11:20	0.501	0.376	0.376
1/15/2018	23:55	9.2	11:40	12.9	11.0	10:30	0.4	21:00	0.8	0.6	4:05	0.238	11:35	0.455	0.349	0.349
1/16/2018	4:30	7.4	21:45	12.6	10.6	12:40	0.4	6:10	0.7	0.6	4:00	0.234	8:30	0.428	0.337	0.337
1/17/2018	4:45	9.6	21:10	13.4	11.3	8:40	0.4	18:45	0.8	0.5	3:20	0.235	21:05	0.514	0.342	0.342
1/18/2018	3:20	9.4	21:05	14.3	12.4	16:05	0.4	0:05	0.7	0.6	3:00	0.294	20:55	0.527	0.416	0.416
1/19/2018	23:55	9.8	9:10	13.9	11.9	11:45	0.5	19:55	0.8	0.6	4:20	0.331	9:10	0.486	0.412	0.412
1/20/2018	5:40	8.0	10:40	13.4	10.3	7:25	0.5	16:50	0.8	0.7	5:25	0.297	12:40	0.523	0.405	0.405
1/21/2018	5:35	7.4	12:25	13.4	10.8	17:50	0.3	10:10	0.8	0.6	17:50	0.230	19:40	0.524	0.384	0.384
1/22/2018	23:55	9.4	8:10	13.3	11.3	12:45	0.3	1:05	0.6	0.4	23:35	0.167	7:10	0.412	0.271	0.271
1/23/2018	4:40	7.5	21:15	12.8	10.7	1:10	0.4	21:00	0.9	0.6	4:05	0.159	21:00	0.633	0.381	0.381
1/24/2018	5:00	10.0	20:30	15.0	12.7	13:35	0.5	20:50	0.8	0.7	13:35	0.354	20:50	0.655	0.493	0.493
1/25/2018	23:55	10.2	8:10	14.2	12.5	8:25	0.5	21:45	0.9	0.7	5:10	0.398	8:05	0.592	0.486	0.486
1/26/2018	4:15	8.3	20:55	13.6	11.4	23:00	0.5	9:10	0.8	0.7	4:35	0.319	20:15	0.550	0.438	0.438
1/27/2018	23:55	11.1	11:15	15.8	13.5	22:35	0.4	12:40	0.9	0.7	22:35	0.294	12:40	0.675	0.525	0.525
1/28/2018	6:05	9.3	12:10	14.4	12.1	23:15	0.4	9:10	0.8	0.7	23:15	0.296	12:00	0.608	0.461	0.461
1/29/2018	4:30	10.5	15:40	15.2	12.8	10:05	0.4	18:30	0.9	0.6	1:45	0.297	18:30	0.749	0.467	0.467
1/30/2018	4:25	9.6	20:45	13.9	12.1	5:25	0.6	20:45	0.7	0.7	4:40	0.320	20:45	0.548	0.459	0.459
1/31/2018	23:55	9.6	8:20	13.6	11.6	23:40	0.7	8:20	0.7	0.7	23:40	0.351	8:20	0.528	0.438	0.438
ReportAvg	11.2					0.6					0.364					
ReportTotal											11.29					

ADS Environmental Services

Pipe Height: 15.00

Date	REN_MH1763\mp1\DFINAL (inches)					REN_MH1763\mp1\VFINAL (feet/sec)					REN_MH1763\mp1\QFINAL (MGD - Total MG)					
	Time	Min.	Time	Max.	Average	Time	Min.	Time	Max.	Average	Time	Min.	Time	Max.	Average	Total
2/1/2018	4:05	7.6	8:30	12.7	10.3	7:15	0.6	4:05	0.7	0.7	4:05	0.280	8:30	0.459	0.376	0.376
2/2/2018	3:50	8.9	11:15	12.8	10.9	16:00	0.6	0:00	0.6	0.6	3:50	0.310	11:15	0.426	0.369	0.369
2/3/2018	5:20	8.1	10:55	13.5	10.6	9:00	0.6	5:20	0.6	0.6	5:20	0.281	10:55	0.467	0.359	0.359
2/4/2018	4:55	8.3	10:45	13.8	10.8	12:15	0.6	4:55	0.6	0.6	4:55	0.288	10:45	0.484	0.366	0.366
2/5/2018	4:05	7.7	20:15	13.1	10.9	18:25	0.6	4:05	0.6	0.6	4:05	0.267	20:15	0.442	0.369	0.369
2/6/2018	15:30	8.9	0:00	11.6	9.9	6:20	0.6	15:30	0.6	0.6	17:55	0.301	7:20	0.394	0.338	0.338
2/7/2018	4:15	6.9	8:55	12.0	9.3	8:25	0.6	4:55	0.7	0.6	3:15	0.229	8:55	0.401	0.317	0.317
2/8/2018	4:15	6.4	9:00	12.2	9.2	13:05	0.5	7:15	0.8	0.6	4:15	0.212	9:00	0.439	0.316	0.316
2/9/2018	4:45	6.5	19:20	11.8	9.8	22:45	0.3	6:10	0.8	0.5	16:55	0.177	8:15	0.368	0.271	0.271
2/10/2018	23:55	8.1	0:00	11.0	9.3	6:05	0.2	22:10	0.6	0.4	6:05	0.096	13:35	0.316	0.214	0.214
2/11/2018	5:00	5.8	11:35	12.4	8.9	16:40	0.2	21:35	0.6	0.5	16:40	0.108	21:35	0.341	0.222	0.222
2/12/2018	4:40	5.5	9:25	11.2	8.5	12:45	0.3	6:55	0.6	0.4	2:55	0.086	21:25	0.276	0.189	0.189
2/13/2018	3:45	5.4	8:25	11.2	8.3	11:30	0.3	23:40	0.8	0.5	3:55	0.092	23:40	0.352	0.204	0.204
2/14/2018	5:05	5.6	8:20	11.4	8.5	11:15	0.2	22:45	0.7	0.4	3:55	0.100	22:45	0.336	0.199	0.199
2/15/2018	4:40	5.3	8:30	11.4	8.2	17:30	0.2	23:25	0.6	0.4	17:30	0.091	8:50	0.279	0.177	0.177
2/16/2018	3:40	5.4	8:25	11.3	9.3	11:25	0.3	5:30	0.6	0.4	2:50	0.119	8:35	0.294	0.219	0.219
2/17/2018	5:10	8.2	10:55	12.7	9.6	16:05	0.4	19:55	0.7	0.5	16:50	0.185	18:30	0.341	0.256	0.256
2/18/2018	5:55	6.1	11:20	12.5	9.1	18:35	0.3	0:00	0.6	0.5	5:35	0.124	12:50	0.403	0.235	0.235
2/19/2018	4:30	5.9	11:40	11.9	8.6	20:00	0.2	5:00	0.6	0.4	2:50	0.083	11:20	0.308	0.174	0.174
2/20/2018	4:40	5.5	10:10	11.8	8.4	0:10	0.2	5:55	0.6	0.4	0:10	0.074	10:15	0.359	0.197	0.197
2/21/2018	4:00	5.3	9:40	10.8	8.2	12:45	0.2	18:00	0.6	0.5	3:50	0.102	21:00	0.278	0.195	0.195
2/22/2018	4:10	5.2	11:40	10.9	8.1	13:35	0.2	0:40	0.6	0.4	3:25	0.087	20:45	0.274	0.193	0.193
2/23/2018	4:10	5.2	10:10	10.9	8.0	10:40	0.3	0:35	0.5	0.4	5:20	0.078	11:25	0.281	0.156	0.156
2/24/2018	4:35	5.3	11:00	11.9	8.3	20:35	0.3	9:50	0.4	0.4	4:05	0.077	11:00	0.246	0.160	0.160
2/25/2018	5:25	5.4	10:50	12.1	8.6	2:05	0.3	5:50	0.4	0.3	5:25	0.091	10:50	0.220	0.164	0.164
2/26/2018	4:35	5.3	21:10	11.6	9.2	21:00	0.3	0:55	0.4	0.3	4:35	0.090	21:10	0.211	0.170	0.170
2/27/2018	15:55	7.2	0:00	10.0	8.4	15:20	0.3	18:05	0.6	0.4	16:00	0.118	20:55	0.264	0.174	0.174
2/28/2018	3:45	5.3	8:30	11.1	8.2	3:15	0.3	19:50	0.5	0.4	3:15	0.071	9:45	0.249	0.156	0.156
ReportAvg	9.1					0.5					0.240					
ReportTotal											6.734					

ADS Environmental Services

Pipe Height: 15.00

Date	REN_MH1763\mp1\DFINAL (inches)					REN_MH1763\mp1\VFINAL (feet/sec)					REN_MH1763\mp1\QFINAL (MGD - Total MG)					
	Time	Min.	Time	Max.	Average	Time	Min.	Time	Max.	Average	Time	Min.	Time	Max.	Average	Total
4/1/2018	4:30	4.6	9:00	11.1	8.0	5:15	0.2	20:25	0.5	0.4	4:30	0.046	9:00	0.294	0.176	0.176
4/2/2018	3:05	4.5	8:35	10.6	7.5	3:05	0.2	8:35	0.5	0.4	3:05	0.044	8:35	0.275	0.162	0.162
4/3/2018	4:00	4.5	8:05	10.8	7.4	4:00	0.2	7:05	0.5	0.4	4:00	0.045	7:40	0.285	0.157	0.157
4/4/2018	2:55	4.4	7:30	10.8	7.6	2:55	0.2	7:30	0.5	0.4	2:55	0.041	7:30	0.282	0.167	0.167
4/5/2018	3:20	4.6	7:30	10.8	7.6	3:20	0.2	7:30	0.5	0.4	3:20	0.048	7:30	0.284	0.167	0.167
4/6/2018	3:25	4.8	8:10	11.2	9.1	3:25	0.3	8:10	0.5	0.4	3:25	0.056	8:10	0.297	0.221	0.221
4/7/2018	3:15	7.5	10:40	13.5	10.9	3:15	0.4	10:40	0.5	0.5	3:15	0.165	10:40	0.400	0.290	0.290
4/8/2018	6:25	8.1	10:30	12.1	10.0	6:25	0.4	10:30	0.5	0.5	6:25	0.188	10:30	0.329	0.257	0.257
4/9/2018	3:20	6.9	9:25	11.7	9.2	3:20	0.4	9:25	0.5	0.4	3:20	0.140	9:25	0.316	0.224	0.224
4/10/2018	3:15	6.3	8:30	12.2	9.1	1:10	0.3	20:05	0.5	0.4	1:10	0.125	8:40	0.332	0.217	0.217
4/11/2018	3:30	6.2	8:30	11.5	9.0	3:30	0.4	17:35	0.5	0.4	3:30	0.111	8:30	0.307	0.210	0.210
4/12/2018	3:15	6.7	20:55	12.1	10.3	3:20	0.4	5:15	0.5	0.4	3:20	0.130	20:55	0.332	0.261	0.261
4/13/2018	2:55	9.2	19:55	12.1	11.0	14:15	0.4	0:20	0.5	0.5	2:55	0.227	19:55	0.332	0.292	0.292
4/14/2018	3:50	10.2	21:30	15.9	13.5	0:10	0.4	21:30	0.7	0.6	3:50	0.264	21:30	0.580	0.426	0.426
4/15/2018	23:55	10.5	0:00	15.0	13.1	21:15	0.3	0:00	0.6	0.5	6:15	0.216	0:00	0.501	0.335	0.335
4/16/2018	3:40	9.0	21:25	14.7	12.0	1:40	0.4	21:25	0.6	0.5	4:15	0.220	21:25	0.484	0.333	0.333
4/17/2018	23:55	11.7	20:40	14.4	13.1	7:40	0.4	20:40	0.6	0.5	23:45	0.300	20:40	0.462	0.373	0.373
4/18/2018	3:15	10.7	7:10	13.6	12.2	6:30	0.3	8:35	0.5	0.4	6:30	0.226	7:45	0.399	0.309	0.309
4/19/2018	23:55	8.2	7:05	13.0	11.2	21:25	0.4	7:05	0.5	0.4	23:50	0.168	7:05	0.374	0.284	0.284
4/20/2018	2:05	7.1	7:40	12.5	10.6	8:00	0.3	11:15	0.5	0.4	2:05	0.148	7:15	0.346	0.259	0.259
4/21/2018	6:10	7.7	0:00	10.7	9.4	16:30	0.4	12:50	0.6	0.5	5:50	0.176	12:50	0.345	0.246	0.246
4/22/2018	3:40	6.2	8:50	11.5	9.1	2:55	0.3	20:10	0.6	0.4	3:40	0.111	20:10	0.320	0.223	0.223
ReportAvg	10.1					0.4					0.254					
ReportTotal											5.588					

REN_MH2116

Located At: Shattuck Ave and Tobin St (see attached site report for details)
Monitoring Period: January 17, 2018 – April 22, 2018
Pipe Dimensions: 14.38"
Finalized Silt Level: 0 mm

Site Data Characteristics: This site is located in a sanitary sewer pipe. The scattergraph indicates site operated in free flow conditions. The site did surcharge during the monitoring period. The dry weather data plots below the Froude =1 curve indicating subcritical flow.

Site Data Bias & Editing: The depth and velocity measurements recorded by the flow monitor were consistent with field confirmations conducted to date and supported the relative accuracy of the flow monitor at this location. The finalized depth data utilized the upward ultrasonic sensor.

Site Data Uptime: The data uptime achieved during the monitoring period is provided in the table below. This location was installed on January 17, 2018 after the official monitoring period had begun as directed by the client. Based upon the quality and consistency of the observed flow depth and velocity data, the Continuity equation was used to calculate the flow rate for the monitoring period.

Entity	Percentage Uptime	
	Raw	Final
Depth (in)	100%	100%
Velocity (f/s)	100%	100%
Quantity (mgd)	100%	100%

Site Data Summary: The average flow depth, velocity, and quantity data observed during the monitoring period along with observed minimum and maximum data, are provided in the following table. The minimum and maximum rates recorded in the tables are based on 5-minute data intervals.

Item	Depth (in)	Velocity (f/s)	Quantity (mgd)	% Full
Minimum	3.57	2.15	0.309	25%
Maximum	20.21	3.36	2.248	100%
Average	6.09	2.86	0.844	42%

Renton.Carlolo.I&I.WA17

Flow Monitoring Site Report



Site Name

REN_MH2116

Site Address /Location: Shattuck Ave S and S Tobin St

Monitor Series

TRITON+

Location Type

Temporary

Site Access Details: Site located in middle of street in front of school

Latitude: 47.483765°
Longitude: -122.211201°

Pipe Size (H x W)
14.38 X 14.50

Pipe Shape
Circular

Manhole #

MH2116

System Characteristics

Residential / Commercial

Access

Drive

Traffic

Light

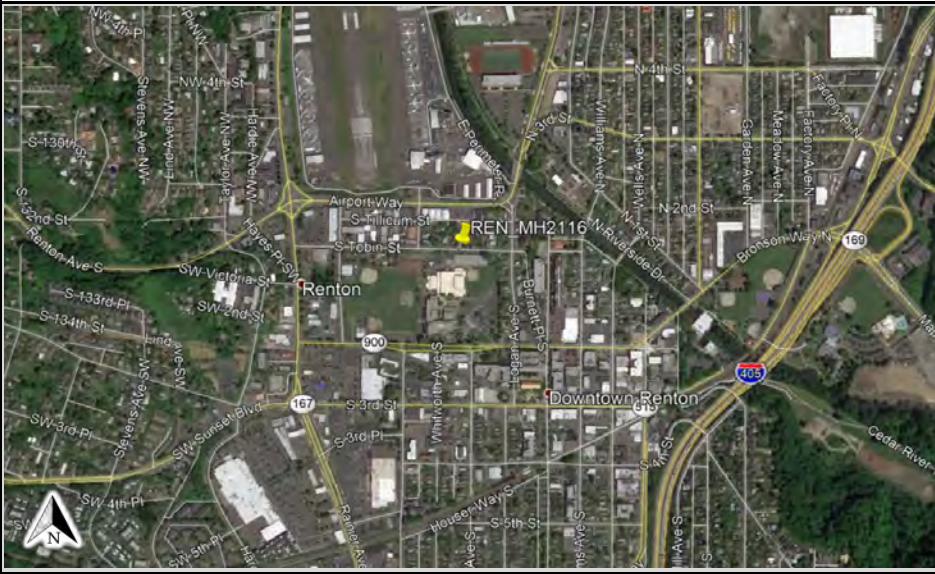

Installation Information

Installation Date: Wednesday, January 17, 2018	Installation Type: Doppler Standard Ring and Crank
Monitoring Location (Sensors): Downstream 0-5 FT	Monitor Location: Manhole
Sensors / Devices: Peak Combo (CS4), Smart Depth (CS5)	Pressure Sensor Range (psi) 0 - 5 psi

Installation Confirmation:

Confirmation Time: 2:11:00 PM	Pipe Size (HxW) 14.38 X 14.50
Depth of Flow (Wet DOF) (in) 6.50"	
CS5 Physical Offset (in) 1.38"	Measurement Confidence (in) 0.25"
Peak Velocity (fps) 3.36	Velocity Sensor Offset (in) 0"
Silt (in) 0.00"	Silt Type

Hydraulic Comments:

Straight, Some Ripples

Manhole / Pipe Information:

Manhole Depth (Approx. FT): 15'	Manhole Configuration Sanitary Sewer Overflow
Manhole Material: PVC	Manhole Condition: Good
Manhole Opening Diameter (in) 20"	Manhole Diameter (Approx.): 20"
Manhole Cover Unbolted	Manhole Frame Normal
Active Connections No	Air Quality: Normal
Pipe Material Vitrified Clay Pipe	Pipe Condition: Fair

Communication Information:

Communication Type Wireless	Antenna Location Manhole Pick / Vent Hole
--------------------------------	--

Additional Site Info. / Comments:

Renton traffic control required.



ADS Project Name: Renton.Carlolo.I&I.WA17

ADS Project Number: 22275.11.325

Additional Photos

Inlet



Outlet



Location Map

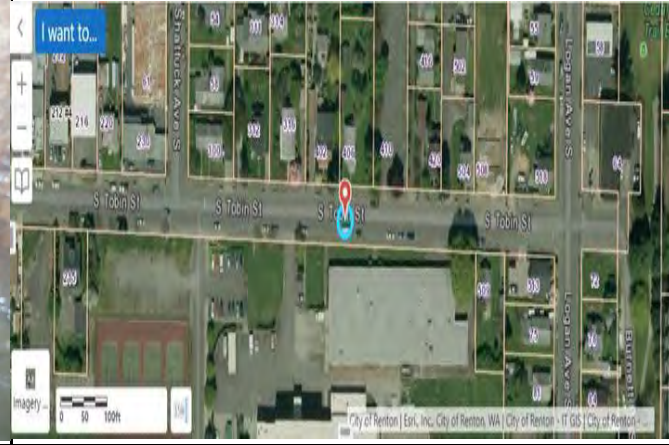

Top Down





Location

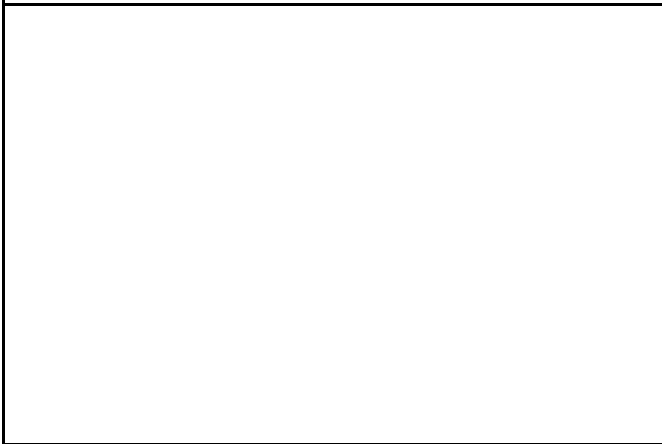

Google Map



KEY

-  Flow Direction
-  Monitoring Point

HYDROGRAPH REPORT

REN_MH2116

Flow Monitor
REN_MH2116

Pipe Height
14.38 in

Report Period
12/22/2017
To
4/22/2018

Legend
— Depth
— Velocity

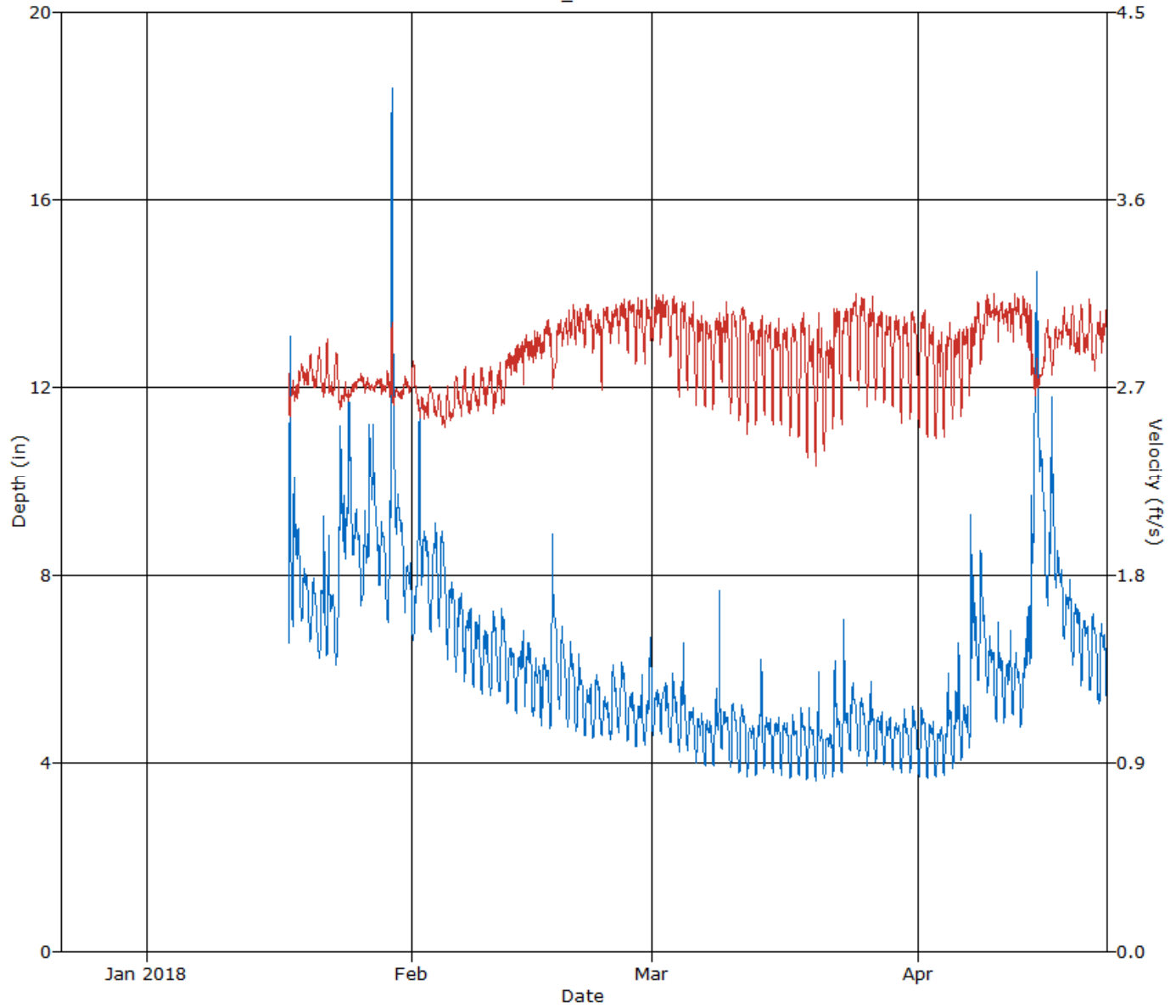

HYDROGRAPH REPORT

REN_MH2116

Flow Monitor
REN_MH2116

Pipe Height
14.38 in.

Report Period
12/22/2017
To
4/22/2018

Legend
Quantity

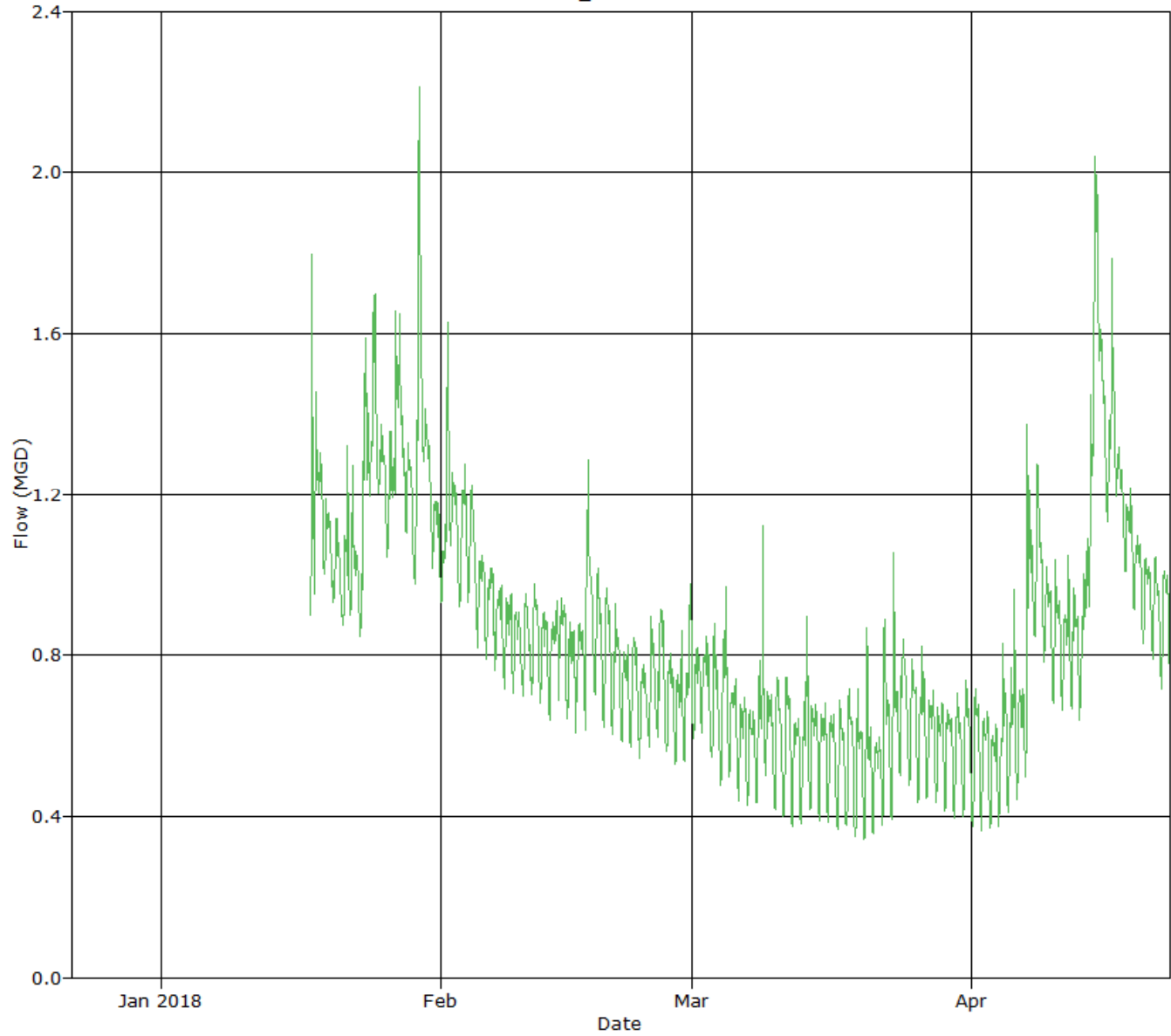

SCATTERGRAPH REPORT

REN_MH2116

Flow Monitor
REN_MH2116

Pipe Height
14.38 in

Report Period
12/22/2017
To
4/22/2018

Legend
○ Depth - Velocity
--- Iso-Q™
--- Silt
▼ Min-Max Depth

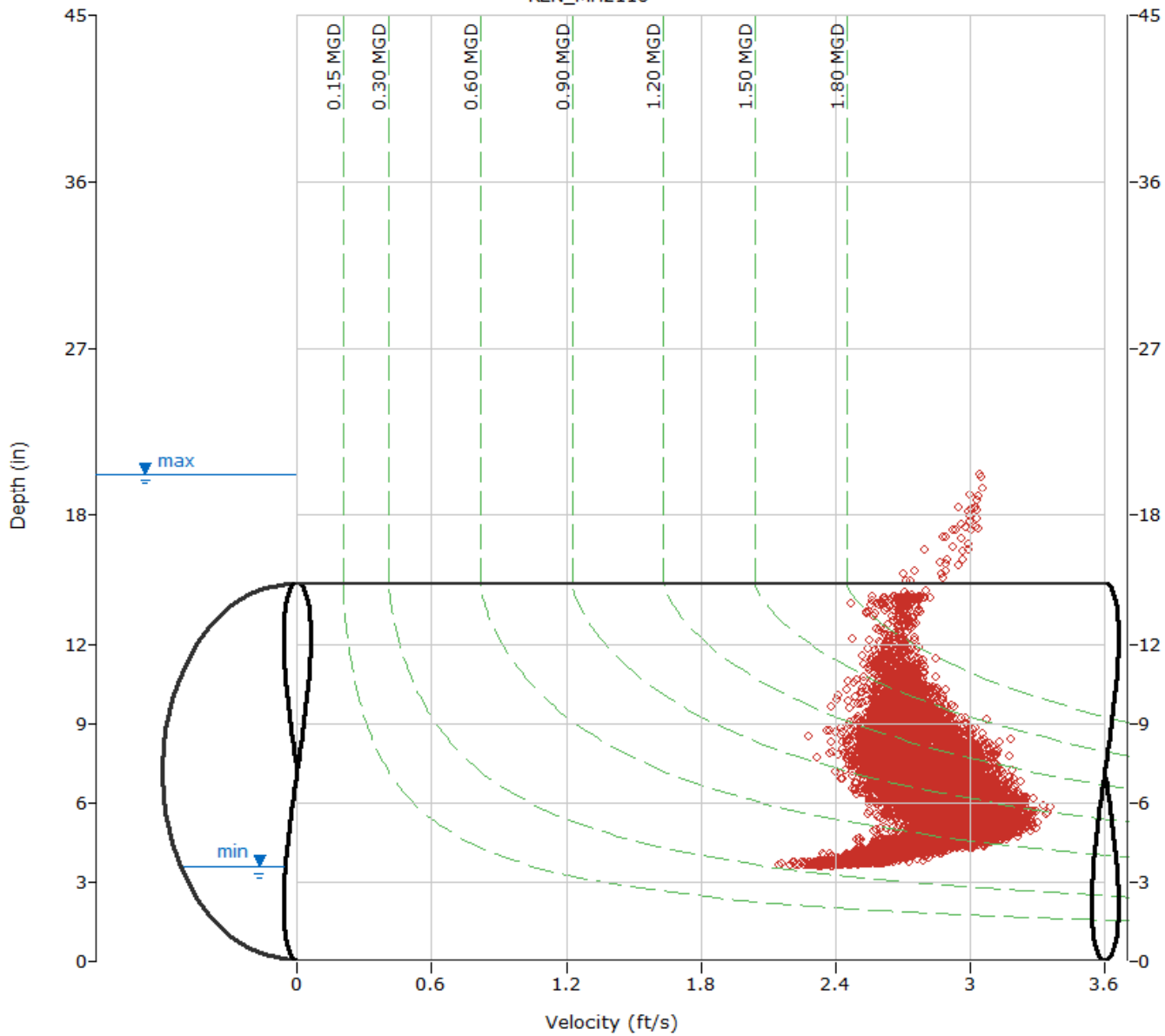

ADS Environmental Services

Pipe Height: 14.38

Date	REN_MH2116\mp1\DFINAL (inches)					REN_MH2116\mp1\VFINAL (feet/sec)					REN_MH2116\mp1\QFINAL (MGD - Total MG)					
	Time	Min.	Time	Max.	Average	Time	Min.	Time	Max.	Average	Time	Min.	Time	Max.	Average	Total
2/1/2018	3:15	6.4	21:45	13.0	8.2	22:50	2.4	3:00	2.9	2.7	5:25	0.878	21:45	1.801	1.149	1.149
2/2/2018	23:55	7.2	8:40	9.8	8.4	20:50	2.4	15:30	2.8	2.6	23:55	0.965	11:10	1.406	1.165	1.165
2/3/2018	4:40	6.6	18:55	9.7	8.0	22:55	2.4	0:50	2.8	2.6	2:55	0.879	18:55	1.376	1.101	1.101
2/4/2018	3:20	6.7	13:20	9.7	7.9	11:55	2.4	2:30	2.7	2.6	3:50	0.881	13:20	1.359	1.069	1.069
2/5/2018	3:55	6.2	14:45	8.6	7.3	10:45	2.3	4:10	2.8	2.6	3:10	0.800	14:45	1.196	0.968	0.968
2/6/2018	3:30	5.9	18:45	8.4	6.9	18:25	2.5	4:20	2.8	2.7	3:55	0.772	12:15	1.173	0.934	0.934
2/7/2018	4:20	5.7	13:15	8.0	6.7	14:50	2.4	4:25	3.0	2.7	3:05	0.738	14:15	1.103	0.894	0.894
2/8/2018	3:30	5.6	18:15	7.9	6.5	18:15	2.4	4:05	2.9	2.7	2:30	0.699	8:10	1.140	0.864	0.864
2/9/2018	3:40	5.4	11:15	7.9	6.3	19:10	2.5	0:45	2.9	2.7	3:40	0.687	11:15	1.120	0.833	0.833
2/10/2018	4:25	5.3	13:30	8.0	6.3	11:10	2.4	5:15	3.1	2.7	4:15	0.658	14:35	1.117	0.836	0.836
2/11/2018	4:50	5.5	13:40	8.1	6.4	11:25	2.4	0:55	3.0	2.7	5:10	0.666	13:40	1.120	0.849	0.849
2/12/2018	2:20	5.2	19:30	7.5	6.0	13:35	2.6	23:05	3.1	2.8	2:15	0.646	14:00	1.110	0.822	0.822
2/13/2018	3:55	5.0	23:25	7.9	5.9	18:00	2.6	7:20	3.1	2.8	3:55	0.585	23:25	1.152	0.816	0.816
2/14/2018	4:40	5.2	17:20	7.7	6.1	19:10	2.6	9:45	3.2	2.9	3:55	0.653	17:20	1.129	0.864	0.864
2/15/2018	3:05	5.0	11:15	7.1	5.7	9:30	2.6	21:25	3.2	2.9	3:10	0.620	11:10	1.034	0.783	0.783
2/16/2018	1:45	4.7	9:30	7.1	5.7	8:35	2.7	23:45	3.2	2.9	1:40	0.580	9:30	1.066	0.801	0.801
2/17/2018	4:00	4.7	9:05	9.6	6.6	10:55	2.5	5:00	3.2	2.9	3:25	0.593	9:05	1.468	0.934	0.934
2/18/2018	5:40	5.0	12:00	7.8	6.0	14:05	2.6	23:45	3.2	3.0	4:25	0.669	13:00	1.177	0.863	0.863
2/19/2018	4:40	4.7	11:30	7.1	5.7	2:05	2.8	7:50	3.3	3.0	5:20	0.589	12:35	1.080	0.810	0.810
2/20/2018	4:00	4.6	13:10	7.5	5.4	13:15	2.7	15:30	3.2	3.0	2:40	0.567	13:10	1.151	0.762	0.762
2/21/2018	2:00	4.5	20:15	6.4	5.2	2:45	2.7	23:50	3.2	3.0	2:45	0.548	20:10	0.963	0.719	0.719
2/22/2018	3:30	4.5	12:35	6.7	5.3	4:55	2.7	17:05	3.2	3.0	4:55	0.539	12:30	0.995	0.725	0.725
2/23/2018	3:05	4.6	13:30	6.2	5.0	3:05	2.5	13:30	3.3	3.0	3:05	0.501	13:30	0.989	0.686	0.686
2/24/2018	4:45	4.4	11:40	6.6	5.2	7:25	2.8	20:10	3.3	3.0	4:15	0.557	11:40	1.003	0.730	0.730
2/25/2018	4:30	4.5	11:25	6.9	5.4	4:35	2.8	20:00	3.2	3.0	4:35	0.561	14:30	1.073	0.777	0.777
2/26/2018	3:50	4.4	16:35	6.5	5.0	3:30	2.8	9:10	3.3	3.0	3:30	0.536	16:30	1.021	0.702	0.702
2/27/2018	3:20	4.2	20:20	6.7	5.0	3:00	2.7	10:55	3.3	3.0	3:15	0.500	20:15	0.980	0.682	0.682
2/28/2018	4:00	4.3	19:10	7.4	5.3	1:10	2.8	9:40	3.3	3.0	3:55	0.525	19:10	1.154	0.738	0.738
ReportAvg	6.2					2.8					0.853					
ReportTotal											23.88					

ADS Environmental Services

Pipe Height: 14.38

Date	REN_MH2116\mp1\DFINAL (inches)					REN_MH2116\mp1\VFINAL (feet/sec)					REN_MH2116\mp1\QFINAL (MGD - Total MG)					
	Time	Min.	Time	Max.	Average	Time	Min.	Time	Max.	Average	Time	Min.	Time	Max.	Average	Total
3/1/2018	3:40	4.5	13:50	6.3	5.1	1:10	2.8	19:50	3.3	3.0	3:10	0.563	13:50	0.973	0.722	0.722
3/2/2018	1:15	4.5	9:00	6.5	5.2	2:50	2.8	7:50	3.2	3.1	1:10	0.569	9:00	1.019	0.741	0.741
3/3/2018	3:05	4.4	10:40	6.4	5.0	4:10	2.7	13:45	3.2	3.0	4:10	0.524	10:40	0.960	0.695	0.695
3/4/2018	4:20	4.2	16:15	7.2	5.0	4:10	2.5	9:55	3.2	2.9	4:15	0.440	16:10	1.115	0.684	0.684
3/5/2018	3:55	4.1	12:00	5.8	4.8	3:30	2.6	19:30	3.3	2.9	3:55	0.460	8:40	0.882	0.640	0.640
3/6/2018	3:30	3.9	19:00	5.7	4.6	3:35	2.5	16:55	3.2	2.9	3:35	0.401	20:55	0.839	0.597	0.597
3/7/2018	3:30	3.9	9:35	5.5	4.6	1:10	2.5	17:30	3.3	2.9	4:15	0.406	9:35	0.784	0.582	0.582
3/8/2018	4:15	3.8	21:15	8.9	4.9	2:55	2.4	12:40	3.2	2.9	2:55	0.389	21:15	1.393	0.650	0.650
3/9/2018	3:25	4.2	9:05	5.9	4.7	2:15	2.5	11:15	3.3	2.9	2:15	0.459	9:05	0.869	0.626	0.626
3/10/2018	4:00	3.8	10:45	6.0	4.6	5:00	2.4	12:15	3.2	2.9	5:15	0.389	12:15	0.911	0.596	0.596
3/11/2018	3:50	3.7	10:50	6.0	4.6	4:15	2.4	14:45	3.3	2.9	3:50	0.371	10:50	0.903	0.591	0.591
3/12/2018	2:25	3.7	10:15	5.6	4.4	3:30	2.3	14:15	3.2	2.8	3:30	0.346	10:15	0.824	0.554	0.554
3/13/2018	2:50	3.7	18:55	7.0	4.7	1:00	2.3	6:55	3.2	2.9	1:00	0.353	18:55	1.055	0.595	0.595
3/14/2018	3:00	3.8	19:55	5.6	4.6	4:05	2.5	7:10	3.2	2.9	2:20	0.395	12:25	0.813	0.589	0.589
3/15/2018	2:25	3.8	11:00	5.7	4.5	1:20	2.4	6:40	3.3	2.8	2:00	0.375	6:40	0.872	0.570	0.570
3/16/2018	2:20	3.7	17:45	5.6	4.5	3:45	2.3	18:30	3.2	2.8	3:45	0.360	17:45	0.801	0.554	0.554
3/17/2018	3:05	3.7	10:30	5.7	4.4	2:30	2.3	16:10	3.1	2.8	5:30	0.351	10:30	0.842	0.544	0.544
3/18/2018	3:25	3.7	10:20	5.8	4.4	2:20	2.3	15:10	3.2	2.8	2:40	0.351	10:20	0.881	0.547	0.547
3/19/2018	2:55	3.6	8:15	5.7	4.4	2:25	2.2	8:15	3.1	2.8	2:25	0.321	8:15	0.849	0.534	0.534
3/20/2018	1:45	3.6	9:25	6.2	4.5	2:05	2.2	9:05	3.1	2.8	2:05	0.309	9:25	0.940	0.545	0.545
3/21/2018	2:35	3.6	10:45	5.0	4.3	3:00	2.2	9:50	3.1	2.8	3:00	0.331	9:50	0.680	0.516	0.516
3/22/2018	3:25	3.7	8:45	6.6	4.8	1:45	2.3	9:40	3.3	2.9	1:45	0.355	8:50	0.967	0.628	0.628
3/23/2018	3:10	3.7	9:50	7.8	4.9	3:35	2.4	17:50	3.2	2.9	3:05	0.372	9:20	1.183	0.649	0.649
3/24/2018	1:50	4.2	9:20	6.1	5.1	2:45	2.5	15:25	3.3	3.0	2:45	0.458	9:20	0.932	0.700	0.700
3/25/2018	3:10	4.1	9:35	5.9	4.8	2:00	2.5	13:40	3.3	3.0	3:15	0.437	13:40	0.883	0.641	0.641
3/26/2018	2:40	3.8	12:35	6.4	4.8	1:50	2.4	19:00	3.2	2.9	1:50	0.376	12:35	0.955	0.632	0.632
3/27/2018	1:55	3.8	19:50	5.5	4.7	1:50	2.5	16:55	3.2	2.9	1:55	0.396	19:50	0.794	0.608	0.608
3/28/2018	2:50	3.9	16:55	5.2	4.6	3:05	2.5	9:55	3.2	2.9	2:50	0.406	16:55	0.745	0.589	0.589
3/29/2018	2:20	3.8	17:25	5.3	4.5	3:10	2.5	7:35	3.2	2.9	3:10	0.384	9:25	0.760	0.576	0.576
3/30/2018	2:05	3.7	12:10	6.1	4.5	2:00	2.3	13:05	3.2	2.9	2:00	0.346	12:10	0.926	0.569	0.569
3/31/2018	2:35	3.7	12:50	5.8	4.5	2:55	2.4	11:25	3.3	2.9	2:55	0.362	11:25	0.858	0.577	0.577
ReportAvg	4.7					2.9					0.608					
ReportTotal											18.84					

ADS Environmental Services

Pipe Height: 14.38

Date	REN_MH2116\mp1\DFINAL (inches)					REN_MH2116\mp1\VFINAL (feet/sec)					REN_MH2116\mp1\QFINAL (MGD - Total MG)					
	Time	Min.	Time	Max.	Average	Time	Min.	Time	Max.	Average	Time	Min.	Time	Max.	Average	Total
4/1/2018	4:10	3.7	10:05	5.6	4.5	4:05	2.3	17:05	3.2	2.9	4:05	0.346	10:05	0.824	0.572	0.572
4/2/2018	2:05	3.6	19:45	5.6	4.5	2:35	2.4	7:10	3.2	2.8	1:55	0.353	19:45	0.812	0.555	0.555
4/3/2018	3:15	3.7	16:35	5.3	4.4	1:40	2.3	20:45	3.1	2.8	1:40	0.350	17:40	0.729	0.527	0.527
4/4/2018	1:40	3.7	13:35	6.4	4.7	0:10	2.4	7:20	3.2	2.8	1:40	0.356	13:35	0.902	0.592	0.592
4/5/2018	2:20	3.8	18:45	7.5	4.9	0:55	2.4	17:55	3.1	2.8	2:15	0.381	18:45	1.140	0.633	0.633
4/6/2018	2:45	3.9	18:15	6.3	4.8	2:30	2.4	7:20	3.2	2.9	2:40	0.387	18:15	0.933	0.610	0.610
4/7/2018	1:05	4.2	5:20	10.3	6.6	0:20	2.6	22:55	3.2	2.9	1:05	0.468	5:20	1.541	0.965	0.965
4/8/2018	2:30	5.6	8:50	9.5	7.0	11:00	2.7	2:35	3.3	3.0	2:30	0.803	8:50	1.466	1.054	1.054
4/9/2018	23:55	5.4	13:40	7.4	6.1	20:05	2.8	21:35	3.2	3.1	1:40	0.736	18:05	1.154	0.907	0.907
4/10/2018	2:10	4.9	8:55	7.5	5.9	8:35	2.7	11:35	3.2	3.1	1:55	0.640	8:45	1.156	0.862	0.862
4/11/2018	1:35	4.8	20:00	7.4	5.8	10:30	2.8	0:35	3.3	3.0	1:35	0.638	19:55	1.125	0.844	0.844
4/12/2018	2:55	4.8	10:45	6.9	5.7	3:55	2.7	6:00	3.2	3.1	23:10	0.616	10:45	1.115	0.822	0.822
4/13/2018	1:35	4.7	19:10	8.1	6.0	22:05	2.8	8:45	3.4	3.0	1:10	0.574	19:10	1.243	0.875	0.875
4/14/2018	3:15	6.0	19:35	16.0	9.9	16:50	2.5	3:25	3.2	2.8	3:15	0.867	19:40	2.183	1.460	1.460
4/15/2018	23:10	7.7	1:05	13.8	10.1	0:25	2.6	21:35	3.1	2.8	23:00	1.160	0:00	2.026	1.526	1.526
4/16/2018	4:15	7.1	14:35	13.3	8.9	6:50	2.6	0:50	3.1	2.9	3:50	1.071	14:35	1.972	1.368	1.368
4/17/2018	23:55	7.0	6:30	9.4	8.0	20:35	2.7	13:15	3.2	3.0	23:10	1.045	10:35	1.515	1.236	1.236
4/18/2018	23:55	6.3	16:55	8.5	7.2	7:55	2.7	10:20	3.2	3.0	4:35	0.934	16:50	1.326	1.103	1.103
4/19/2018	23:45	5.9	16:20	8.2	6.9	12:55	2.7	3:20	3.2	2.9	2:00	0.848	17:40	1.255	1.019	1.019
4/20/2018	3:15	5.6	8:35	7.7	6.6	10:55	2.7	2:55	3.2	3.0	2:45	0.797	13:15	1.160	0.965	0.965
4/21/2018	3:40	5.5	10:10	7.8	6.4	15:45	2.5	0:30	3.2	2.9	4:10	0.742	10:10	1.170	0.921	0.921
4/22/2018	3:35	5.1	11:00	7.3	6.2	10:35	2.7	23:00	3.1	3.0	3:55	0.670	18:00	1.118	0.899	0.899
ReportAvg	6.4					2.9					0.923					
ReportTotal											20.31					

REN_MH2171

Located At: 540 Burnett Ave S (see attached site report for details)
Monitoring Period: December 22, 2017 – April 22, 2018
Pipe Dimensions: 11.25"
Finalized Silt Level: 0 mm

Site Data Characteristics: This site is located in a sanitary sewer pipe. The scattergraph indicates site operated in free flow conditions. The site did not surcharge during the monitoring period. The dry weather data plots below the Froude =1 curve indicating subcritical flow.

Site Data Bias & Editing: The depth and velocity measurements recorded by the flow monitor were consistent with field confirmations conducted to date and supported the relative accuracy of the flow monitor at this location. The finalized depth data utilized the upward ultrasonic sensor.

Site Data Uptime: The data uptime achieved during the monitoring period is provided in the table below. Based upon the quality and consistency of the observed flow depth and velocity data, the Continuity equation was used to calculate the flow rate for the monitoring period.

Entity	Percentage Uptime Raw	Percentage Uptime Final
Depth (in)	100%	100%
Velocity (f/s)	100%	100%
Quantity (mgd)	100%	100%

Site Data Summary: The average flow depth, velocity, and quantity data observed during the monitoring period along with observed minimum and maximum data, are provided in the following table. The minimum and maximum rates recorded in the tables are based on 5-minute data intervals.

Item	Depth (in)	Velocity (f/s)	Quantity (mgd)	% Full
Minimum	2.66	0.80	0.067	24%
Maximum	8.34	2.40	0.840	74%
Average	4.37	1.32	0.222	39%

Renton.Carollo.I&I.WA17

Flow Monitoring Site Report



Site Name

REN_MH2171

Site Address /Location: 540 Burnett Ave S

Monitor Series

TRITON+

Location Type

Temporary

Site Access Details:

Located in sidewalk in front of home.

Latitude:

47.475159°

Pipe Size (H x W)

11.25" x 11.25"

Longitude:

-122.207887°

Pipe Shape

Circular

Manhole #

MH2171

System Characteristics

Residential

Access

Drive

Traffic

Light

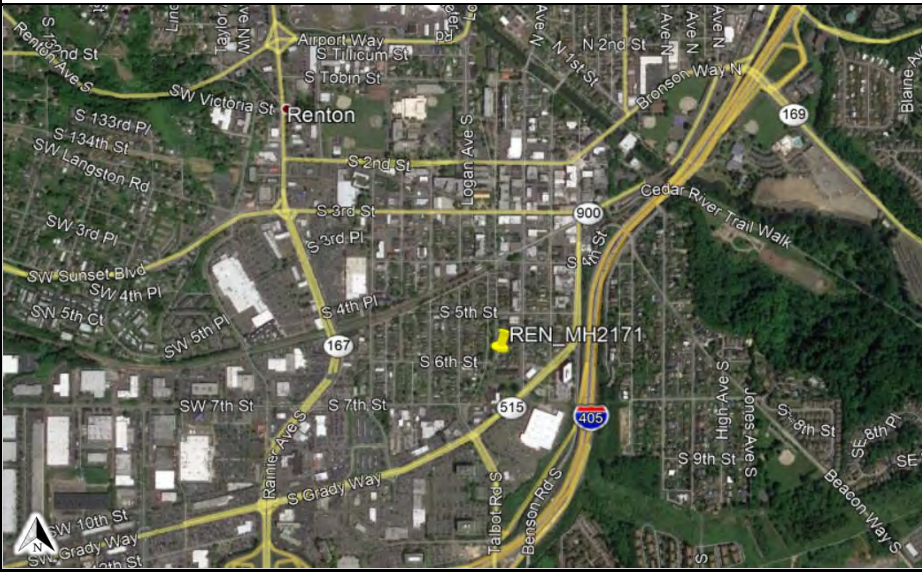

Installation Information

Installation Date:	12.14.17	Installation Type:	Doppler Standard Ring and Crank
Monitoring Location (Sensors):	Upstream 0-5 FT	Monitor Location:	Manhole
Sensors / Devices:	Peak Combo (CS4), Smart Depth (CS5)	Pressure Sensor Range (psi)	0 - 5 psi

Installation Confirmation:

Confirmation Time:	1:42:00 PM	Pipe Size (HxW)	11.25" x 11.25"
Depth of Flow (Wet DOF) (in)	~4.50"	Range (Air DOF) (in)	
Downlooker Physical Offset (in)	0	Measurement Confidence (in)	0.25"
Peak Velocity (fps)	~1.5 FPS	Velocity Sensor Offset (in)	
Silt (in)	0	Silt Type	

Hydraulic Comments:

Moderate, slow flow

Manhole / Pipe Information:

Manhole Depth (Approx. FT):	~8'	Manhole Configuration	Single
Manhole Material:	Concrete	Manhole Condition:	Good
Manhole Opening Diameter (in)	20"	Manhole Diameter (Approx.):	20"
Manhole Cover	Unbolted	Manhole Frame	Normal
Active Drop Connections	No	Air Quality:	Normal
Pipe Material	PVC	Pipe Condition:	Good

Communication Information:

Communication Type	Wireless	Antenna Location	Manhole Pick / Vent Hole
--------------------	----------	------------------	--------------------------

Additional Site Info. / Comments:

Site located in walkway. Monitoring point is in a recessed pipe entry.

ADS Project Name: Renton.Carollo.I&I.WA17

ADS Project Number: 22275.11.325

Additional Photos

Upstream



Downstream



Side Inlet



Top Down



Location



Location



Flow Direction



Monitoring Point

HYDROGRAPH REPORT

REN_MH2171

Flow Monitor
REN_MH2171

Pipe Height
11.25 in

Report Period
12/22/2017
To
4/22/2018

Legend
— Depth
— Velocity
— Rain

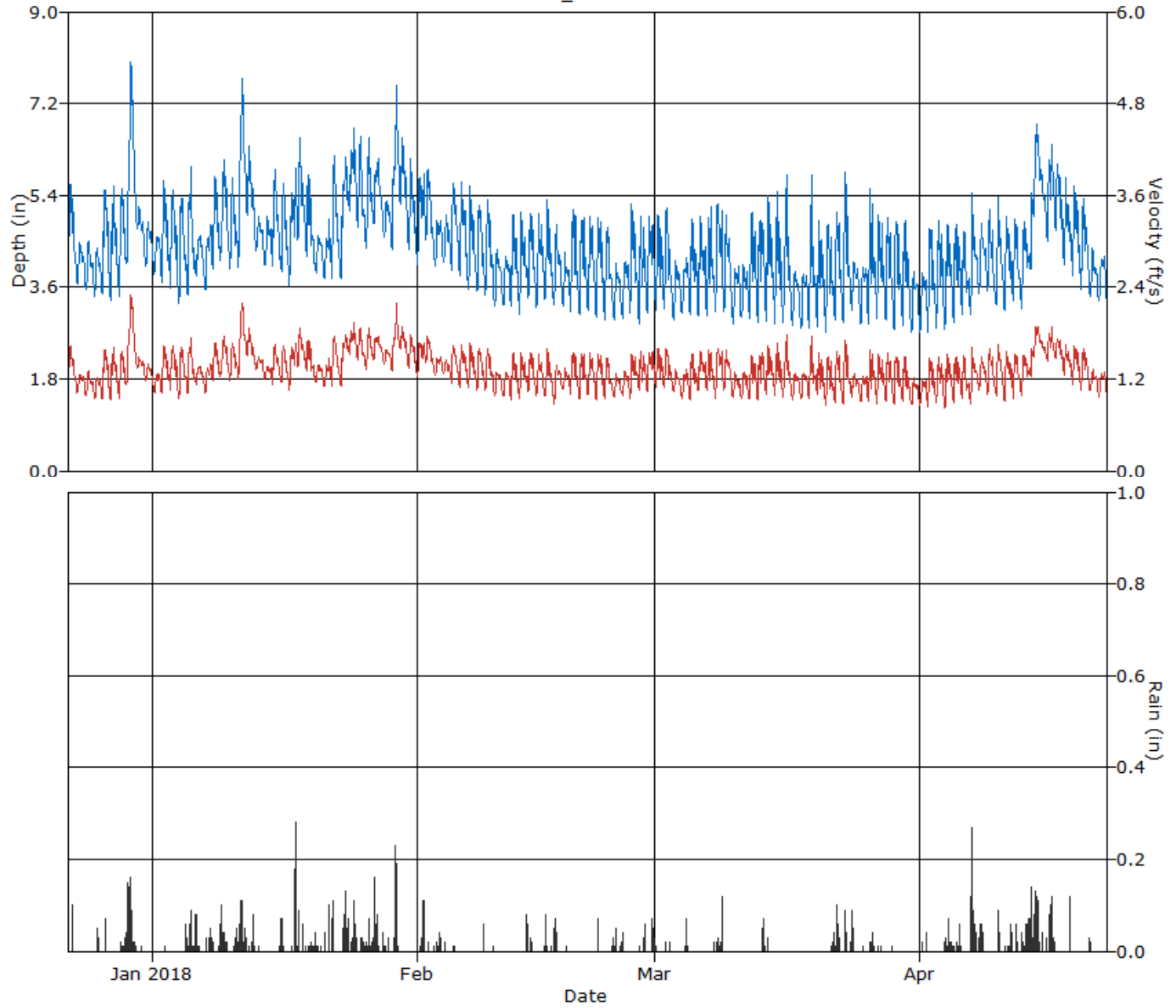

HYDROGRAPH REPORT

REN_MH2171

Flow Monitor
REN_MH2171

Pipe Height
11.25 in.

Report Period
12/22/2017
To
4/22/2018

Legend
— Quantity
— Rain

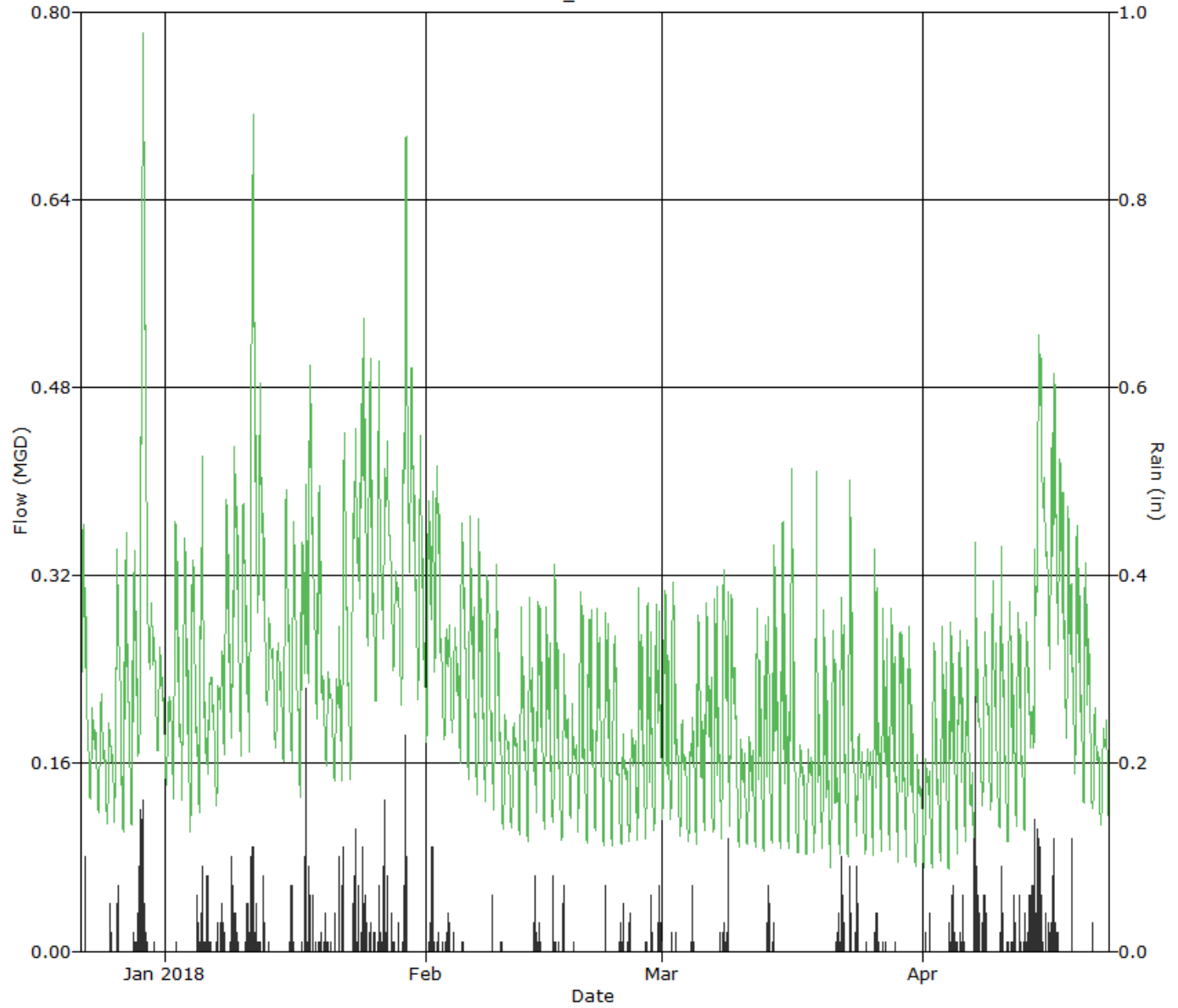

SCATTERGRAPH REPORT

REN_MH2171

Flow Monitor
REN_MH2171

Pipe Height
11.25 in

Report Period
12/22/2017
To
4/22/2018

Legend
○ Depth - Velocity
- - - Iso-Q™
- - - Silt
▼ Min-Max Depth

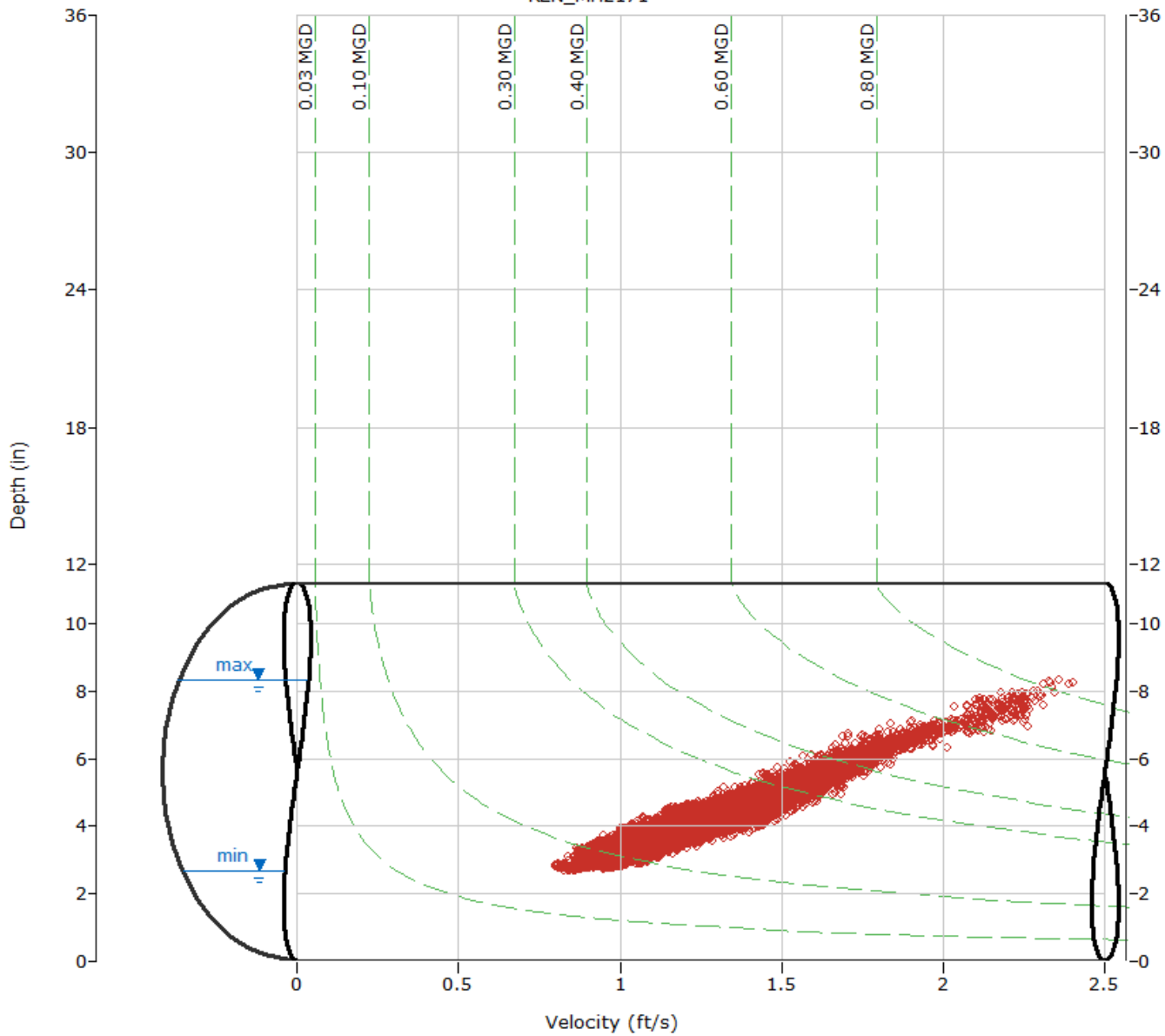

ADS Environmental Services

Pipe Height: 11.25

Date	REN_MH2171\mp1\DFINAL (inches)					REN_MH2171\mp1\VFINAL (feet/sec)					REN_MH2171\mp1\QFINAL (MGD - Total MG)						REN_RG\mp1\RAIN (inches)	
	Time	Min.	Time	Max.	Average	Time	Min.	Time	Max.	Average	Time	Min.	Time	Max.	Average	Total	Total	
12/22/2017	3:35	3.8	10:10	6.0	4.7	3:15	1.1	8:50	1.7	1.4	3:35	0.142	10:10	0.392	0.247	0.247	0.10	
12/23/2017	4:50	3.6	11:10	4.8	4.1	3:45	1.0	11:10	1.3	1.2	3:45	0.125	11:10	0.244	0.171	0.171	0.00	
12/24/2017	5:00	3.5	12:30	4.7	4.0	5:10	1.0	12:35	1.4	1.1	4:00	0.115	12:40	0.236	0.164	0.164	0.00	
12/25/2017	4:10	3.4	10:10	4.5	3.9	3:40	0.9	10:15	1.3	1.1	4:10	0.106	10:15	0.213	0.153	0.153	0.14	
12/26/2017	3:20	3.4	9:25	5.9	4.5	3:15	0.9	9:20	1.6	1.3	3:15	0.104	9:25	0.374	0.219	0.219	0.17	
12/27/2017	3:20	3.3	10:00	6.0	4.4	3:25	0.9	10:00	1.7	1.3	3:25	0.097	10:00	0.410	0.209	0.209	0.00	
12/28/2017	2:10	3.4	11:35	5.7	4.5	1:10	0.9	11:20	1.7	1.3	2:10	0.106	11:20	0.377	0.222	0.222	0.25	
12/29/2017	0:05	4.1	10:45	8.3	6.3	0:00	1.1	10:35	2.4	1.8	0:00	0.161	10:35	0.840	0.486	0.486	1.57	
12/30/2017	23:40	4.4	10:00	5.2	4.9	3:30	1.3	12:45	1.5	1.4	23:40	0.213	10:05	0.307	0.260	0.260	0.02	
12/31/2017	5:10	4.0	11:05	4.9	4.5	5:45	1.2	11:05	1.4	1.3	5:45	0.168	11:05	0.269	0.211	0.211	0.00	
ReportAvg	4.6					1.3					0.234							
ReportTotal																	2.343	2.25

ADS Environmental Services

Pipe Height: 11.25

Date	REN_MH2171\mp1\DFINAL (inches)					REN_MH2171\mp1\VFINAL (feet/sec)					REN_MH2171\mp1\QFINAL (MGD - Total MG)					REN_RG\mp1\RAIN (inches)	
	Time	Min.	Time	Max.	Average	Time	Min.	Time	Max.	Average	Time	Min.	Time	Max.	Average	Total	Total
1/1/2018	4:30	3.8	16:10	4.9	4.3	6:15	1.0	17:10	1.3	1.2	5:10	0.137	16:10	0.247	0.183	0.183	0.00
1/2/2018	3:20	3.6	8:00	5.9	4.6	3:20	1.0	8:25	1.7	1.3	3:20	0.124	8:25	0.408	0.238	0.238	0.01
1/3/2018	3:15	3.5	10:55	5.9	4.6	23:55	1.0	10:55	1.7	1.4	2:50	0.121	10:55	0.407	0.237	0.237	0.00
1/4/2018	3:45	3.2	12:40	5.7	4.5	2:10	0.9	8:55	1.7	1.3	3:45	0.099	8:55	0.370	0.225	0.225	0.09
1/5/2018	3:30	3.4	12:15	7.1	4.6	3:35	1.0	12:10	2.0	1.4	3:20	0.113	12:15	0.587	0.239	0.239	0.42
1/6/2018	3:00	3.7	14:05	4.7	4.3	3:05	1.1	10:20	1.4	1.3	3:00	0.137	14:05	0.246	0.198	0.198	0.24
1/7/2018	4:55	3.5	20:15	4.9	4.3	4:55	1.0	18:55	1.4	1.2	4:55	0.123	20:25	0.260	0.196	0.196	0.38
1/8/2018	1:20	3.9	8:55	7.1	4.8	1:40	1.2	8:55	2.0	1.4	2:00	0.163	8:55	0.605	0.261	0.261	0.14
1/9/2018	0:00	4.1	8:15	6.4	5.1	23:55	1.2	8:10	1.8	1.5	23:55	0.181	8:15	0.469	0.301	0.301	0.46
1/10/2018	2:05	3.9	7:25	6.0	4.8	1:45	1.1	10:30	1.7	1.5	2:10	0.161	7:25	0.411	0.271	0.271	0.22
1/11/2018	2:00	3.9	13:25	7.8	6.0	1:35	1.2	13:20	2.3	1.7	1:45	0.164	13:20	0.748	0.439	0.439	1.04
1/12/2018	23:40	4.6	9:05	6.6	5.5	23:35	1.4	9:05	2.0	1.6	23:40	0.244	9:05	0.541	0.356	0.356	0.20
1/13/2018	3:45	4.2	10:10	5.1	4.6	6:40	1.3	10:50	1.5	1.4	5:00	0.204	10:50	0.292	0.245	0.245	0.02
1/14/2018	5:20	4.0	11:50	5.1	4.5	23:50	1.2	11:15	1.4	1.3	4:40	0.170	11:15	0.270	0.216	0.216	0.00
1/15/2018	2:55	4.0	10:40	6.5	4.9	2:15	1.1	10:40	1.7	1.4	2:50	0.157	10:40	0.458	0.265	0.265	0.04
1/16/2018	23:50	3.8	7:40	5.8	4.7	23:40	1.1	8:45	1.7	1.4	23:45	0.149	8:45	0.389	0.249	0.249	0.26
1/17/2018	2:45	3.6	18:35	6.2	4.9	2:40	1.0	8:15	1.8	1.5	2:45	0.126	18:55	0.434	0.282	0.282	0.79
1/18/2018	2:05	4.4	7:15	6.6	5.4	1:30	1.3	9:05	1.9	1.6	2:05	0.218	7:10	0.518	0.339	0.339	0.40
1/19/2018	3:15	4.2	7:00	6.1	4.8	23:25	1.2	6:40	1.8	1.5	23:25	0.190	9:05	0.433	0.272	0.272	0.10
1/20/2018	5:20	3.8	10:30	4.7	4.3	5:15	1.1	9:35	1.4	1.3	5:15	0.152	9:35	0.250	0.202	0.202	0.10
1/21/2018	4:25	3.8	17:00	5.2	4.3	4:00	1.1	17:00	1.6	1.3	4:00	0.140	17:00	0.325	0.198	0.198	0.16
1/22/2018	1:20	3.7	8:10	6.3	4.9	0:45	1.1	7:45	1.8	1.5	1:15	0.139	7:45	0.465	0.283	0.283	0.34
1/23/2018	2:25	3.7	16:00	6.6	5.2	3:40	1.1	16:10	1.8	1.5	3:00	0.143	16:00	0.491	0.321	0.321	0.79
1/24/2018	3:35	4.9	14:00	7.0	5.9	2:50	1.5	14:05	2.1	1.7	3:35	0.280	14:05	0.593	0.406	0.406	0.51
1/25/2018	23:55	4.5	10:55	6.6	5.4	23:30	1.3	7:15	1.9	1.6	23:55	0.226	10:55	0.520	0.347	0.347	0.14
1/26/2018	3:20	4.3	10:30	7.1	5.3	1:35	1.3	10:35	1.9	1.6	3:20	0.202	10:30	0.566	0.329	0.329	0.36
1/27/2018	0:15	4.7	11:05	6.3	5.6	0:10	1.4	10:55	1.8	1.7	0:10	0.251	11:00	0.464	0.367	0.367	0.61
1/28/2018	5:25	4.5	11:20	5.3	4.9	6:15	1.4	13:00	1.6	1.5	6:15	0.232	12:55	0.332	0.283	0.283	0.07
1/29/2018	2:50	4.3	15:25	8.0	5.9	3:45	1.3	16:15	2.3	1.7	3:40	0.203	15:25	0.773	0.417	0.417	0.90
1/30/2018	23:45	4.5	8:15	7.1	5.6	23:45	1.4	9:10	2.1	1.7	23:45	0.233	9:10	0.583	0.372	0.372	0.00
1/31/2018	23:55	4.2	7:40	6.2	5.0	23:45	1.3	7:45	1.8	1.5	23:50	0.196	7:45	0.465	0.299	0.299	0.00
ReportAvg	5.0					1.5					0.285						
ReportTotal																8.837	8.79

ADS Environmental Services

Pipe Height: 11.25

Date	REN_MH2171\mp1\DFINAL (inches)					REN_MH2171\mp1\VFINAL (feet/sec)					REN_MH2171\mp1\QFINAL (MGD - Total MG)						REN_RG\mp1\RAIN (inches)	
	Time	Min.	Time	Max.	Average	Time	Min.	Time	Max.	Average	Time	Min.	Time	Max.	Average	Total	Total	
2/1/2018	3:05	4.0	7:10	6.2	5.1	3:10	1.2	7:10	1.7	1.5	3:35	0.166	7:10	0.439	0.306	0.306	0.66	
2/2/2018	23:55	4.4	8:30	6.3	5.1	23:25	1.3	6:40	1.8	1.5	23:40	0.218	6:40	0.457	0.309	0.309	0.04	
2/3/2018	5:50	4.0	11:00	5.1	4.5	2:55	1.2	18:15	1.5	1.4	4:35	0.177	18:35	0.296	0.233	0.233	0.31	
2/4/2018	3:50	4.1	13:00	5.1	4.5	23:55	1.2	11:10	1.5	1.3	23:55	0.179	13:00	0.290	0.225	0.225	0.02	
2/5/2018	3:45	3.9	7:55	6.1	4.8	2:30	1.1	7:15	1.7	1.4	3:45	0.157	7:10	0.410	0.258	0.258	0.04	
2/6/2018	23:55	3.7	8:50	6.2	4.6	3:10	1.1	18:10	1.7	1.4	3:10	0.140	8:50	0.432	0.245	0.245	0.00	
2/7/2018	3:40	3.5	7:20	5.9	4.4	1:30	1.1	7:30	1.8	1.4	3:00	0.130	7:30	0.406	0.228	0.228	0.00	
2/8/2018	3:20	3.5	8:30	5.6	4.4	2:20	1.0	6:35	1.7	1.3	2:20	0.124	6:35	0.378	0.219	0.219	0.09	
2/9/2018	3:30	3.4	9:35	5.6	4.3	3:25	1.0	8:20	1.6	1.3	3:30	0.113	9:35	0.352	0.212	0.212	0.01	
2/10/2018	4:20	3.2	10:40	4.6	3.8	3:10	0.9	10:00	1.3	1.2	4:20	0.100	10:00	0.219	0.157	0.157	0.01	
2/11/2018	3:35	3.2	14:30	4.9	3.8	5:55	1.0	14:30	1.5	1.2	3:35	0.102	14:30	0.276	0.153	0.153	0.00	
2/12/2018	2:25	3.2	13:15	5.5	4.1	3:40	0.9	13:15	1.6	1.2	3:40	0.096	13:15	0.351	0.187	0.187	0.00	
2/13/2018	2:50	3.0	7:15	5.3	4.1	2:30	0.9	7:15	1.6	1.3	2:30	0.091	7:15	0.330	0.189	0.189	0.17	
2/14/2018	3:20	3.2	13:15	5.3	4.2	3:40	1.0	9:45	1.6	1.3	3:20	0.104	9:45	0.322	0.205	0.205	0.15	
2/15/2018	3:15	3.2	17:15	5.2	4.1	3:20	1.0	8:15	1.6	1.2	2:25	0.101	6:50	0.308	0.188	0.188	0.00	
2/16/2018	2:05	3.3	10:40	5.6	4.2	1:40	1.0	7:15	1.6	1.2	1:50	0.106	7:15	0.352	0.192	0.192	0.15	
2/17/2018	3:15	3.2	9:20	5.2	4.0	4:00	0.9	9:25	1.4	1.2	3:55	0.093	9:20	0.285	0.171	0.171	0.32	
2/18/2018	4:50	3.2	10:20	4.3	3.7	5:45	1.0	10:05	1.4	1.2	4:50	0.110	10:20	0.219	0.156	0.156	0.01	
2/19/2018	3:30	3.1	13:30	5.7	4.2	3:15	1.0	9:05	1.6	1.3	3:15	0.096	13:30	0.373	0.200	0.200	0.00	
2/20/2018	3:30	3.0	14:40	5.6	4.1	4:10	0.9	14:45	1.7	1.3	3:40	0.090	14:45	0.375	0.188	0.188	0.00	
2/21/2018	3:00	3.0	7:25	5.2	4.0	3:25	1.0	8:10	1.6	1.3	3:25	0.093	8:10	0.314	0.187	0.187	0.00	
2/22/2018	2:55	3.0	14:15	5.2	4.1	2:20	0.9	12:10	1.6	1.3	2:55	0.086	12:10	0.316	0.190	0.190	0.07	
2/23/2018	3:20	2.9	11:00	5.5	4.0	2:15	0.9	12:20	1.6	1.2	3:20	0.086	11:00	0.351	0.178	0.178	0.01	
2/24/2018	5:05	2.9	10:20	4.1	3.6	6:00	1.0	9:10	1.3	1.1	5:05	0.088	10:20	0.191	0.138	0.138	0.13	
2/25/2018	4:15	2.9	18:50	4.3	3.7	4:25	1.0	10:45	1.3	1.2	4:15	0.091	18:50	0.203	0.147	0.147	0.11	
2/26/2018	3:00	3.0	6:35	5.5	4.0	3:00	0.9	6:35	1.6	1.2	3:00	0.089	6:35	0.351	0.184	0.184	0.00	
2/27/2018	3:50	2.9	8:30	5.7	3.9	3:35	1.1	14:35	1.8	1.3	3:50	0.095	14:35	0.390	0.187	0.187	0.19	
2/28/2018	3:30	3.0	17:20	5.2	4.1	3:05	1.0	17:20	1.7	1.4	3:45	0.098	17:20	0.339	0.207	0.207	0.35	
ReportAvg	4.2					1.3					0.201							
ReportTotal																	5.640 2.84	

ADS Environmental Services

Pipe Height: 11.25

Date	REN_MH2171\mp1\DFINAL (inches)					REN_MH2171\mp1\VFINAL (feet/sec)					REN_MH2171\mp1\QFINAL (MGD - Total MG)						REN_RG\mp1\RAIN (inches)	
	Time	Min.	Time	Max.	Average	Time	Min.	Time	Max.	Average	Time	Min.	Time	Max.	Average	Total	Total	
3/1/2018	2:25	3.1	9:20	5.5	4.1	3:40	1.1	9:20	1.7	1.3	3:00	0.108	9:20	0.368	0.200	0.200	0.01	
3/2/2018	1:20	3.1	8:15	5.7	4.1	1:40	1.1	8:15	1.7	1.3	1:20	0.106	8:15	0.388	0.205	0.205	0.07	
3/3/2018	5:30	2.9	10:20	4.3	3.6	23:50	1.0	10:25	1.4	1.2	4:35	0.095	10:20	0.208	0.146	0.146	0.00	
3/4/2018	4:45	3.0	17:35	4.5	3.7	6:15	0.9	17:00	1.4	1.1	4:35	0.091	17:35	0.219	0.145	0.145	0.12	
3/5/2018	2:45	3.0	15:55	5.2	4.1	1:10	0.9	7:50	1.6	1.3	3:15	0.087	7:50	0.311	0.190	0.190	0.00	
3/6/2018	2:25	3.0	21:10	5.3	4.0	3:30	1.0	13:10	1.7	1.3	3:35	0.099	13:10	0.343	0.196	0.196	0.00	
3/7/2018	4:05	3.0	15:10	5.4	4.0	2:40	1.0	15:15	1.7	1.3	2:40	0.098	15:15	0.353	0.192	0.192	0.03	
3/8/2018	3:10	3.0	9:15	5.4	4.3	0:30	0.9	20:40	1.7	1.4	3:10	0.090	20:40	0.356	0.222	0.222	0.37	
3/9/2018	3:40	3.0	10:40	5.5	4.1	2:10	1.0	10:40	1.7	1.3	3:40	0.102	10:40	0.361	0.197	0.197	0.00	
3/10/2018	5:15	2.8	19:15	4.2	3.5	3:10	0.9	10:10	1.3	1.1	5:25	0.085	10:15	0.187	0.137	0.137	0.00	
3/11/2018	2:55	3.0	9:45	4.7	3.5	4:25	0.9	9:40	1.5	1.1	2:55	0.088	9:40	0.255	0.136	0.136	0.00	
3/12/2018	3:15	3.0	13:25	5.4	4.0	1:25	0.9	6:10	1.6	1.2	1:20	0.085	13:25	0.329	0.184	0.184	0.00	
3/13/2018	2:25	2.9	12:05	5.4	4.1	3:10	0.9	15:15	1.6	1.3	2:25	0.083	12:05	0.326	0.200	0.200	0.31	
3/14/2018	2:55	2.9	9:45	6.1	4.1	2:55	1.0	9:45	1.8	1.3	2:55	0.089	9:45	0.445	0.197	0.197	0.04	
3/15/2018	1:55	2.8	8:50	6.1	4.1	2:15	1.0	8:45	1.8	1.3	2:00	0.085	8:50	0.447	0.202	0.202	0.00	
3/16/2018	3:05	2.9	12:00	6.3	4.1	1:50	0.8	11:45	1.9	1.3	1:50	0.079	12:00	0.488	0.210	0.210	0.00	
3/17/2018	3:40	2.8	10:25	4.2	3.5	4:40	0.9	11:40	1.3	1.1	4:00	0.080	11:05	0.183	0.133	0.133	0.00	
3/18/2018	4:55	2.7	8:50	4.2	3.4	2:45	0.9	10:05	1.3	1.1	4:55	0.079	8:50	0.194	0.132	0.132	0.00	
3/19/2018	2:35	2.8	8:40	6.4	3.9	1:50	0.9	8:40	1.9	1.3	2:35	0.082	8:40	0.502	0.188	0.188	0.00	
3/20/2018	0:50	2.8	6:15	5.3	3.8	23:50	0.9	6:10	1.7	1.2	23:50	0.078	6:10	0.349	0.164	0.164	0.00	
3/21/2018	2:00	2.7	7:20	5.3	3.9	3:00	0.8	7:20	1.6	1.2	1:55	0.069	7:20	0.333	0.171	0.171	0.10	
3/22/2018	2:45	2.9	11:50	6.3	4.1	2:35	0.9	11:45	1.8	1.3	2:45	0.079	11:45	0.448	0.196	0.196	0.48	
3/23/2018	2:25	2.8	8:40	6.0	4.2	3:05	0.9	9:05	1.8	1.3	2:25	0.077	9:05	0.420	0.201	0.201	0.31	
3/24/2018	2:05	3.1	10:35	4.2	3.7	1:55	1.0	9:55	1.3	1.1	2:05	0.096	10:35	0.193	0.147	0.147	0.28	
3/25/2018	3:30	2.8	13:50	4.8	3.5	3:35	0.9	13:50	1.4	1.1	3:35	0.080	13:50	0.245	0.134	0.134	0.01	
3/26/2018	3:05	2.8	6:10	5.9	4.1	3:10	0.9	11:15	1.7	1.2	3:15	0.078	11:15	0.396	0.185	0.185	0.17	
3/27/2018	3:00	2.8	5:55	5.5	4.0	2:00	0.9	16:35	1.6	1.2	3:00	0.080	5:55	0.337	0.178	0.178	0.02	
3/28/2018	2:50	2.9	13:10	5.7	4.0	1:15	0.9	13:10	1.7	1.2	2:45	0.084	13:10	0.375	0.177	0.177	0.01	
3/29/2018	1:35	2.8	10:10	5.7	3.9	2:05	0.9	10:10	1.6	1.2	2:05	0.074	10:10	0.365	0.174	0.174	0.00	
3/30/2018	3:00	2.8	13:40	5.4	3.9	3:05	0.9	13:40	1.6	1.2	3:00	0.077	13:40	0.345	0.169	0.169	0.00	
3/31/2018	2:20	2.7	8:35	4.1	3.4	2:20	0.9	8:30	1.3	1.0	2:20	0.070	8:30	0.184	0.120	0.120	0.00	
ReportAvg	3.9					1.2					0.175							
ReportTotal																	5.429	2.33

ADS Environmental Services

Pipe Height: 11.25

Date	REN_MH2171\mp1\DFINAL (inches)					REN_MH2171\mp1\VFINAL (feet/sec)					REN_MH2171\mp1\QFINAL (MGD - Total MG)						REN_RG\mp1\RAIN (inches)	
	Time	Min.	Time	Max.	Average	Time	Min.	Time	Max.	Average	Time	Min.	Time	Max.	Average	Total	Total	
4/1/2018	2:55	2.7	9:30	4.0	3.4	2:30	0.8	9:35	1.2	1.0	2:55	0.070	9:30	0.175	0.121	0.121	0.10	
4/2/2018	2:55	2.7	14:55	5.2	3.8	1:45	0.8	14:55	1.5	1.2	2:55	0.067	14:55	0.306	0.165	0.165	0.00	
4/3/2018	1:50	2.8	17:20	5.2	3.9	1:20	0.9	6:15	1.6	1.2	1:40	0.075	17:25	0.303	0.169	0.169	0.00	
4/4/2018	0:20	2.7	6:05	5.3	3.9	2:20	0.8	12:00	1.6	1.2	1:25	0.068	6:10	0.321	0.176	0.176	0.39	
4/5/2018	1:35	2.9	15:25	5.0	4.0	2:20	0.9	15:30	1.5	1.2	2:40	0.078	15:25	0.290	0.184	0.184	0.25	
4/6/2018	2:05	2.9	8:40	5.0	3.8	23:30	0.9	7:10	1.5	1.2	2:55	0.086	6:00	0.283	0.163	0.163	0.00	
4/7/2018	1:50	3.0	5:15	5.8	4.1	1:05	0.8	5:15	1.7	1.2	1:05	0.083	5:15	0.393	0.190	0.190	0.88	
4/8/2018	2:10	3.4	9:40	4.9	4.2	23:55	1.1	9:55	1.5	1.3	2:10	0.120	8:15	0.281	0.196	0.196	0.45	
4/9/2018	23:05	3.3	7:10	5.7	4.2	2:10	1.0	7:10	1.7	1.3	23:05	0.112	7:10	0.380	0.205	0.205	0.00	
4/10/2018	23:55	3.1	7:35	5.9	4.1	23:55	1.0	7:35	1.8	1.3	23:55	0.096	7:35	0.413	0.200	0.200	0.23	
4/11/2018	0:00	3.1	7:05	5.5	4.1	1:40	0.9	7:05	1.7	1.3	2:30	0.091	7:05	0.358	0.197	0.197	0.31	
4/12/2018	23:50	3.3	8:40	5.2	4.1	2:30	0.9	8:40	1.7	1.3	1:55	0.104	8:40	0.338	0.193	0.193	0.11	
4/13/2018	1:00	3.1	8:10	5.1	4.2	0:40	0.9	8:25	1.6	1.3	1:00	0.096	8:25	0.297	0.205	0.205	0.51	
4/14/2018	2:45	3.9	17:00	7.0	5.5	4:25	1.2	19:15	2.0	1.6	2:45	0.168	17:00	0.574	0.353	0.353	1.52	
4/15/2018	23:45	4.6	0:00	6.6	5.6	20:25	1.5	1:00	1.9	1.7	23:55	0.258	1:00	0.516	0.366	0.366	0.21	
4/16/2018	2:45	4.4	15:00	6.7	5.6	2:40	1.4	14:30	2.0	1.7	2:40	0.224	14:15	0.531	0.369	0.369	0.71	
4/17/2018	23:45	4.2	5:50	6.1	5.2	23:05	1.3	5:25	1.8	1.6	23:45	0.201	5:45	0.433	0.315	0.315	0.01	
4/18/2018	2:30	4.0	6:15	5.8	4.7	23:15	1.2	6:40	1.7	1.4	23:25	0.172	5:50	0.385	0.259	0.259	0.12	
4/19/2018	2:30	3.8	6:00	5.7	4.6	2:35	1.1	5:55	1.7	1.4	2:35	0.145	5:55	0.387	0.246	0.246	0.00	
4/20/2018	2:05	3.5	8:40	5.5	4.4	2:00	1.0	8:40	1.6	1.3	2:05	0.123	8:40	0.355	0.226	0.226	0.00	
4/21/2018	3:55	3.4	9:00	4.6	3.9	0:40	1.0	9:00	1.4	1.2	4:05	0.115	9:00	0.246	0.161	0.161	0.05	
4/22/2018	23:50	3.3	19:50	4.5	3.8	3:40	0.9	19:50	1.4	1.2	3:40	0.102	19:50	0.226	0.157	0.157	0.00	
ReportAvg	4.3					1.3					0.219							
ReportTotal																	4.814	5.85

REN_MH2252

Located At: NE Corner of Rainier and Grady Way (see attached site report for details)
Monitoring Period: December 22, 2017 – April 22, 2018
Pipe Dimensions: 18"
Finalized Silt Level: 0 mm

Site Data Characteristics: This site is located in a sanitary sewer pipe. The scattergraph indicates site operated in free flow conditions. The site did not surcharge during the monitoring period. The dry weather data plots above the Froude =1 curve indicating supercritical flow.

Site Data Bias & Editing: The depth and velocity measurements recorded by the flow monitor were consistent with field confirmations conducted to date and supported the relative accuracy of the flow monitor at this location. The finalized depth data utilized the upward ultrasonic sensor.

Site Data Uptime: The data uptime achieved during the monitoring period is provided in the table below. Based upon the quality and consistency of the observed flow depth and velocity data, the Continuity equation was used to calculate the flow rate for the monitoring period.

Entity	Percentage Uptime Raw	Percentage Uptime Final
Depth (in)	100%	100%
Velocity (f/s)	100%	100%
Quantity (mgd)	100%	100%

Site Data Summary: The average flow depth, velocity, and quantity data observed during the monitoring period along with observed minimum and maximum data, are provided in the following table. The minimum and maximum rates recorded in the tables are based on 5-minute data intervals.

Item	Depth (in)	Velocity (f/s)	Quantity (mgd)	% Full
Minimum	2.49	3.39	0.326	14%
Maximum	6.65	7.64	2.865	37%
Average	3.57	5.10	0.847	20%

Renton.Carollo.I&I.WA17

Flow Monitoring Site Report



Site Name

REN_MH2252

Site Address /Location: Northeast Corner of Rainier Ave and S Grady Way

Monitor Series

TRITON+

Location Type

Temporary

Site Access Details: Located in sidewalk in front of large parking area. Park in parking lot and carry equipment to location.

Latitude: 47.471006°

Longitude: -122.207887°

Pipe Size (H x W)

18.00" x 18.00"

Pipe Shape

Circular

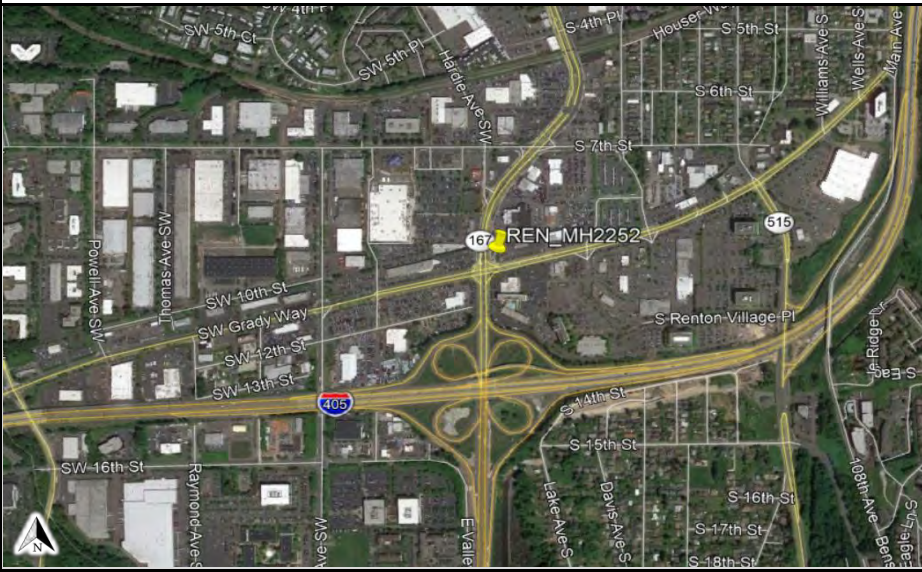

Manhole #	System Characteristics
MH2252	Other
Access	Traffic
Drive	Light



Installation Information

Installation Date:	12.01.17	Installation Type:	Doppler Standard Ring and Crank
Monitoring Location (Sensors):	Upstream 0-5 FT	Monitor Location:	Manhole
Sensors / Devices:	Peak Combo (CS4), Smart Depth (CS5)	Pressure Sensor Range (psi)	0 - 5 psi

Installation Confirmation:

Confirmation Time:	8:50:00 AM	Pipe Size (HxW)	18.00" x 18.00"
Depth of Flow (Wet DOF) (in)	~3.50"	Range (Air DOF) (in)	
Downlooker Physical Offset (in)	1.38"	Measurement Confidence (in)	0.25"
Peak Velocity (fps)	~6.00 FPS	Velocity Sensor Offset (in)	
Silt (in)	0	Silt Type	

Hydraulic Comments:
Moderate, fast flow

Manhole / Pipe Information:

Manhole Depth (Approx. FT):	~8'	Manhole Configuration	Single
Manhole Material:	Concrete	Manhole Condition:	Good
Manhole Opening Diameter (in)	20"	Manhole Diameter (Approx.):	20"
Manhole Cover	Unbolted	Manhole Frame	Normal
Active Drop Connections	No	Air Quality:	Normal
Pipe Material	Concrete	Pipe Condition:	Good

Communication Information:

Communication Type	Wireless	Antenna Location	Manhole Pick / Vent Hole
--------------------	----------	------------------	--------------------------

Additional Site Info. / Comments:

Site located in pedestrian walkway area.



ADS Project Name: Renton.Carollo.I&I.WA17

ADS Project Number: 22275.11.325

Additional Photos

Upstream



Downstream



Side Inlet



Top Down



Location



Location

- Flow Direction
- ⊗ Monitoring Point

HYDROGRAPH REPORT

REN_MH2252

Flow Monitor
REN_MH2252

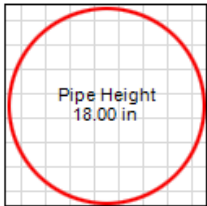

Report Period
12/22/2017
To
4/22/2018

Legend
— Depth
— Velocity
— Rain

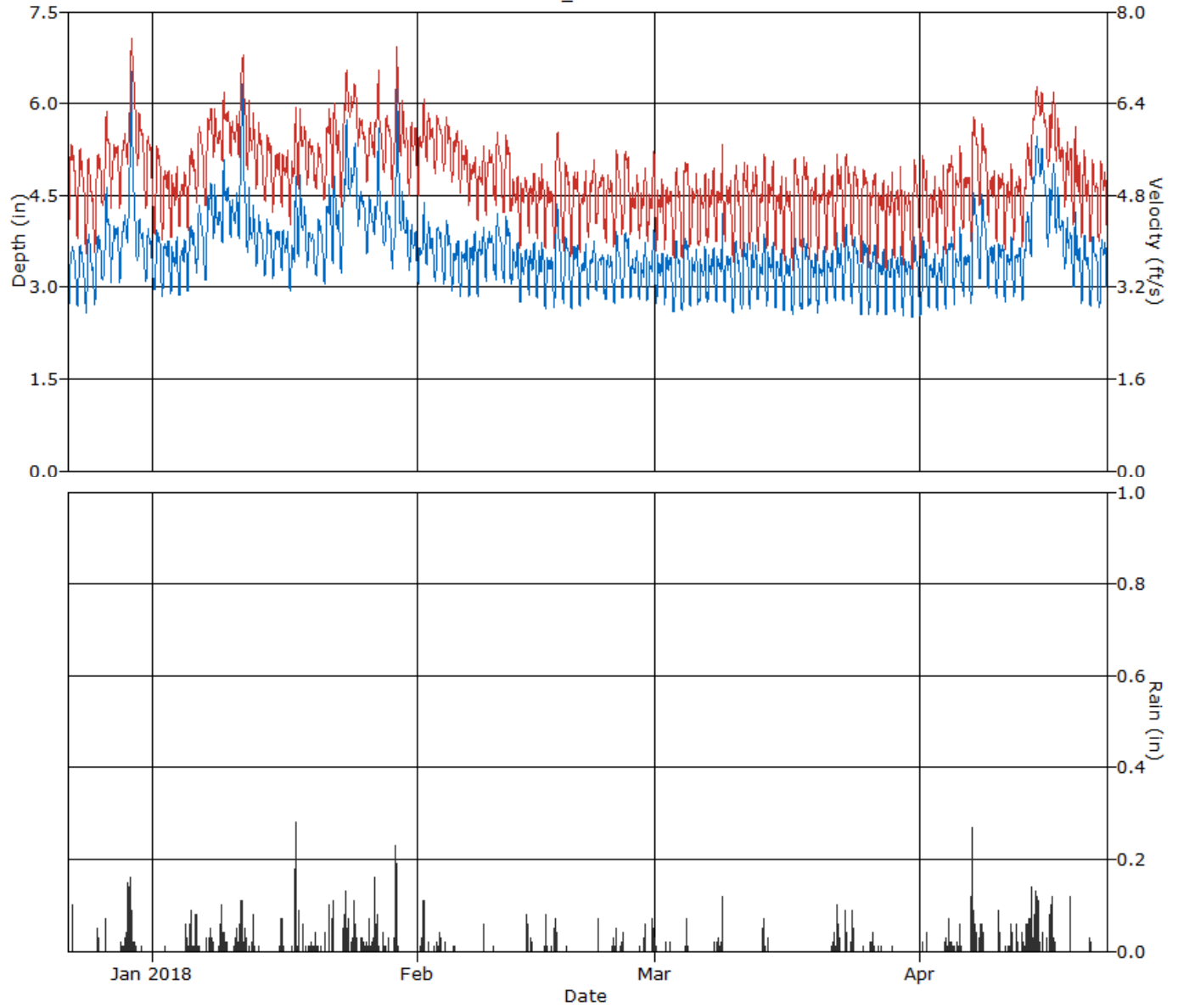

HYDROGRAPH REPORT

REN_MH2252

Flow Monitor
REN_MH2252

Pipe Height
18.00 in.

Report Period
12/22/2017
To
4/22/2018

Legend
— Quantity
— Rain

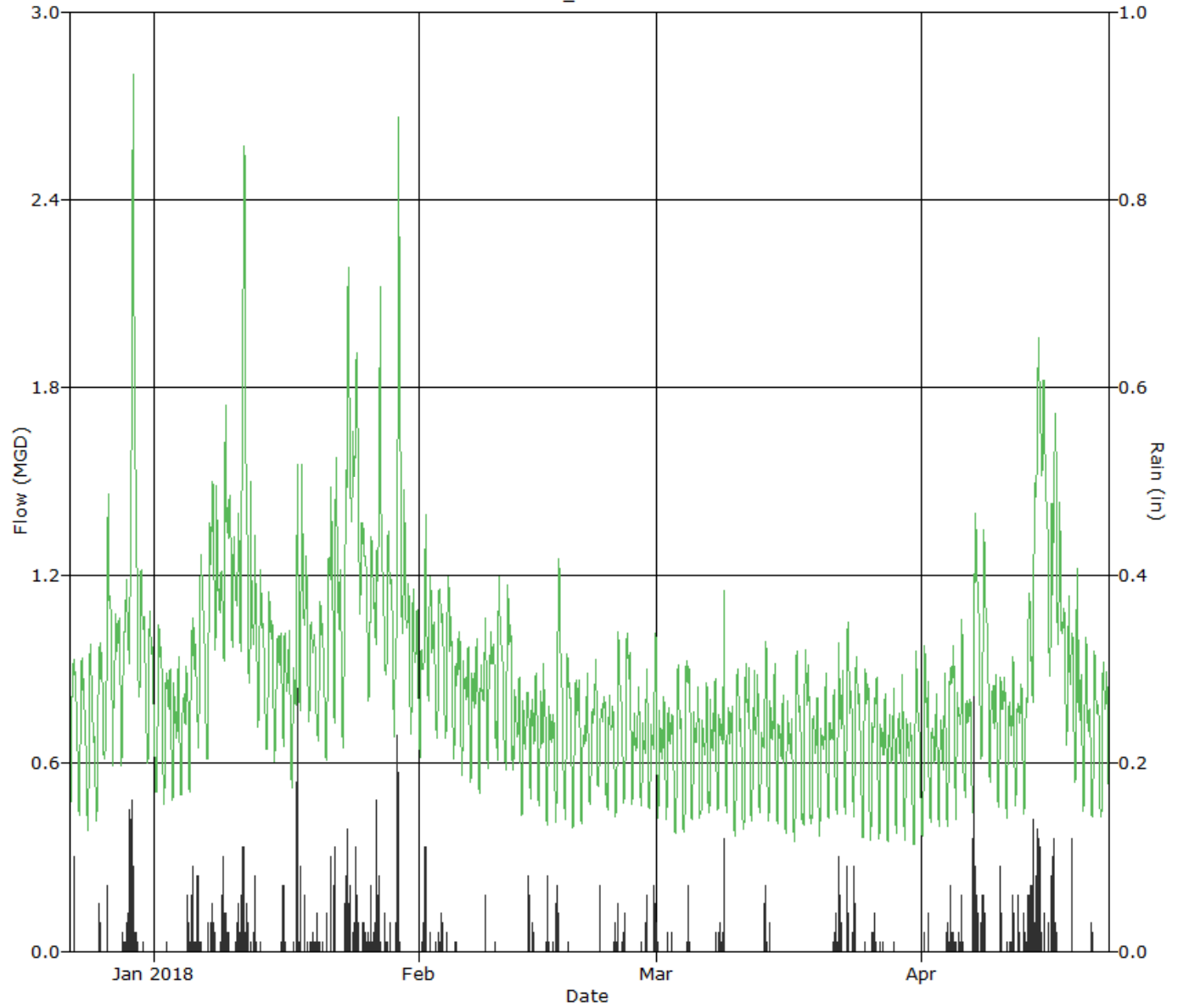

SCATTERGRAPH REPORT

REN_MH2252

Flow Monitor
REN_MH2252

Pipe Height
18.00 in

Report Period
12/22/2017
To
4/22/2018

Legend
○ Depth - Velocity
- - Iso-Q™
- - Silt
▼ Min-Max Depth

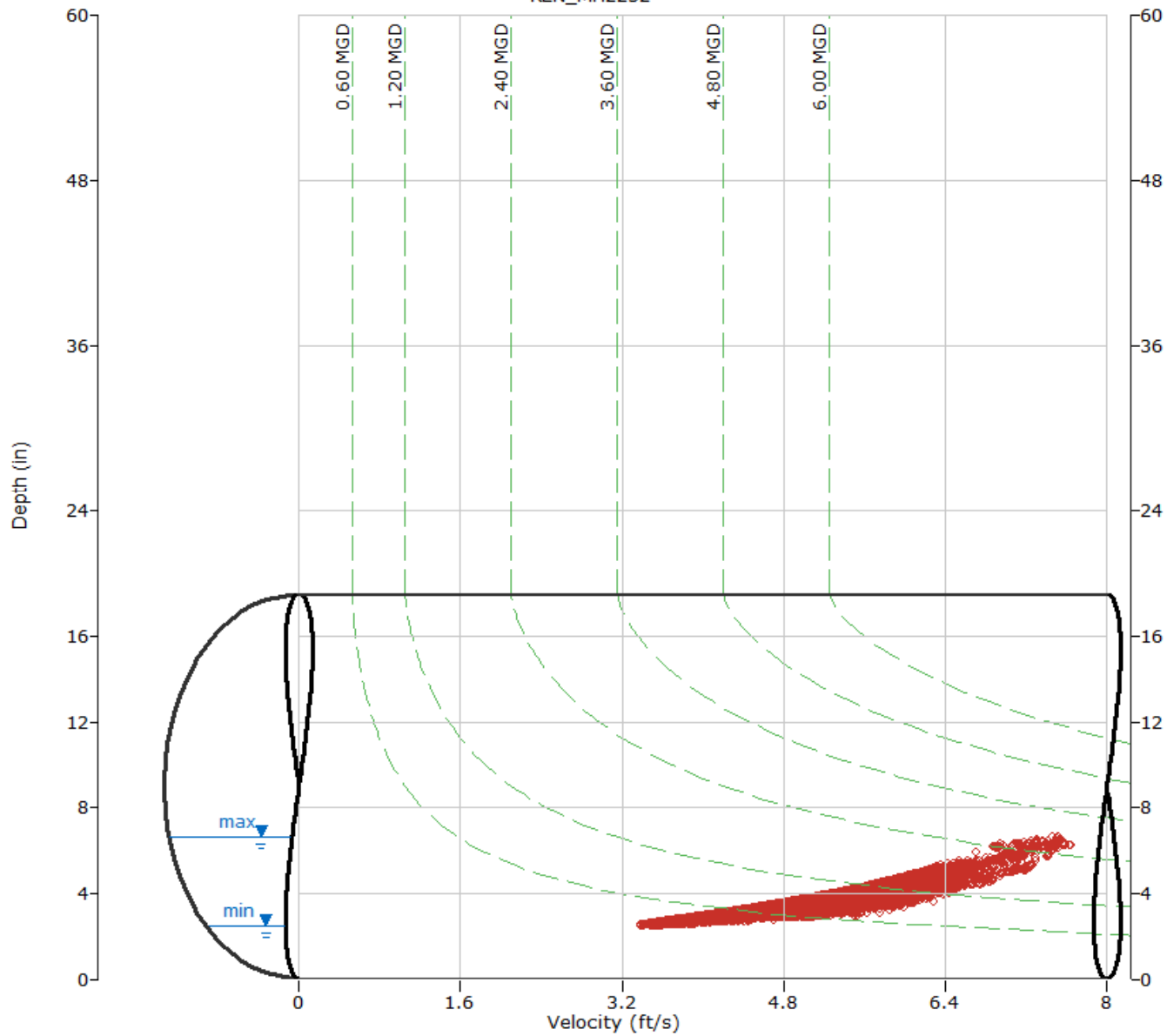

ADS Environmental Services

Pipe Height: 18.00

Date	REN_MH2252\mp1\DFINAL (inches)					REN_MH2252\mp1\VFINAL (feet/sec)					REN_MH2252\mp1\QFINAL (MGD - Total MG)						REN_RG\mp1\RAIN (inches)	
	Time	Min.	Time	Max.	Average	Time	Min.	Time	Max.	Average	Time	Min.	Time	Max.	Average	Total	Total	
12/22/2017	3:35	2.7	12:55	4.1	3.3	3:45	4.2	12:50	6.4	5.2	3:45	0.445	12:50	1.258	0.759	0.759	0.10	
12/23/2017	5:20	2.7	12:40	3.7	3.2	4:10	4.0	11:20	5.7	5.0	4:10	0.425	11:20	0.954	0.707	0.707	0.00	
12/24/2017	4:40	2.6	12:05	3.9	3.3	4:30	3.7	12:30	5.6	4.8	4:30	0.370	12:30	1.004	0.696	0.696	0.00	
12/25/2017	4:25	2.7	14:10	3.9	3.4	4:30	3.6	14:10	5.6	4.9	4:30	0.392	14:10	1.034	0.750	0.750	0.14	
12/26/2017	2:40	3.1	14:20	4.7	3.8	2:40	4.6	14:20	6.3	5.4	2:40	0.599	14:20	1.488	0.961	0.961	0.17	
12/27/2017	3:55	3.0	11:10	4.0	3.7	3:55	4.5	11:10	5.7	5.4	3:55	0.573	11:10	1.095	0.927	0.927	0.00	
12/28/2017	3:20	3.0	16:05	4.3	3.7	3:20	4.5	16:05	6.0	5.4	3:20	0.562	16:05	1.242	0.934	0.934	0.25	
12/29/2017	1:15	3.7	11:05	6.7	4.8	2:45	5.1	12:35	7.6	6.5	2:45	0.869	11:10	2.865	1.643	1.643	1.57	
12/30/2017	5:25	3.4	11:25	4.1	3.7	5:30	5.2	10:25	6.4	5.8	5:30	0.782	10:25	1.241	0.994	0.994	0.02	
12/31/2017	5:40	3.1	11:05	4.0	3.5	5:25	4.5	11:25	6.0	5.3	5:25	0.593	11:25	1.117	0.844	0.844	0.00	
ReportAvg	3.7					5.3					0.921							
ReportTotal																	9.215	2.25

ADS Environmental Services

Pipe Height: 18.00

Date	REN_MH2252\mp1\DFINAL (inches)					REN_MH2252\mp1\VFINAL (feet/sec)					REN_MH2252\mp1\QFINAL (MGD - Total MG)					REN_RG\mp1\RAIN (inches)	
	Time	Min.	Time	Max.	Average	Time	Min.	Time	Max.	Average	Time	Min.	Time	Max.	Average	Total	Total
1/1/2018	4:55	2.9	12:45	4.0	3.5	6:05	4.0	12:45	5.8	5.0	5:20	0.499	12:45	1.103	0.795	0.795	0.00
1/2/2018	3:45	2.8	19:25	3.8	3.4	3:40	3.9	12:05	5.5	4.8	3:40	0.446	20:40	0.935	0.749	0.749	0.01
1/3/2018	2:15	2.9	20:40	3.9	3.4	2:40	3.9	20:40	5.5	4.8	2:40	0.467	20:40	0.991	0.719	0.719	0.00
1/4/2018	4:00	2.8	18:40	3.8	3.4	5:45	4.2	21:45	5.4	4.8	4:00	0.491	18:35	0.930	0.737	0.737	0.09
1/5/2018	3:00	2.9	10:35	4.1	3.6	2:45	4.0	10:45	5.8	5.1	3:00	0.476	10:45	1.121	0.833	0.833	0.42
1/6/2018	3:35	3.2	11:35	4.4	3.9	4:00	4.4	11:35	6.0	5.5	4:00	0.619	11:35	1.291	0.992	0.992	0.24
1/7/2018	3:35	3.1	20:45	4.7	4.0	3:35	4.6	20:45	6.3	5.6	3:35	0.607	20:45	1.513	1.104	1.104	0.38
1/8/2018	4:00	3.8	8:55	4.8	4.1	4:00	5.4	8:55	6.4	5.8	4:00	0.943	8:55	1.563	1.150	1.150	0.14
1/9/2018	4:00	3.7	8:40	5.1	4.4	4:00	5.3	8:40	6.6	6.0	4:00	0.896	8:40	1.756	1.307	1.307	0.46
1/10/2018	3:45	3.8	7:00	4.6	4.2	3:45	5.5	7:00	6.2	5.9	3:45	0.957	7:00	1.439	1.184	1.184	0.22
1/11/2018	2:50	3.8	13:40	6.4	4.9	2:50	5.4	14:10	7.3	6.4	2:50	0.948	13:40	2.669	1.627	1.627	1.04
1/12/2018	4:10	3.6	8:25	4.8	3.9	2:20	5.1	8:20	6.8	5.8	4:10	0.823	8:20	1.644	1.074	1.074	0.20
1/13/2018	5:10	3.3	11:55	4.2	3.8	5:10	4.8	11:00	6.3	5.5	5:10	0.688	11:50	1.263	0.964	0.964	0.02
1/14/2018	4:40	3.2	10:30	4.2	3.7	4:15	4.4	19:20	6.1	5.3	4:20	0.608	10:30	1.186	0.912	0.912	0.00
1/15/2018	3:30	3.1	19:55	3.9	3.6	2:55	4.3	18:40	5.7	5.2	2:55	0.569	19:50	1.042	0.861	0.861	0.04
1/16/2018	5:05	3.2	7:10	4.0	3.6	0:45	4.5	7:20	5.9	5.2	4:30	0.628	7:20	1.097	0.862	0.862	0.26
1/17/2018	4:05	2.9	18:40	5.1	3.7	4:30	4.0	18:35	6.6	5.3	4:30	0.492	18:35	1.761	0.910	0.910	0.79
1/18/2018	2:45	3.5	7:10	4.9	4.1	2:35	4.8	7:55	6.5	5.7	2:35	0.734	7:30	1.600	1.125	1.125	0.40
1/19/2018	4:05	3.3	9:35	3.9	3.7	2:45	4.7	9:40	6.0	5.5	2:45	0.684	9:40	1.088	0.935	0.935	0.10
1/20/2018	3:20	3.1	11:40	4.1	3.7	2:45	4.7	10:45	6.1	5.3	3:20	0.642	10:45	1.164	0.909	0.909	0.10
1/21/2018	5:45	3.0	17:20	4.7	3.9	3:50	4.4	17:20	6.4	5.5	3:50	0.576	17:20	1.530	1.031	1.031	0.16
1/22/2018	4:20	3.3	7:55	5.3	4.1	4:10	4.6	7:55	6.7	5.7	4:10	0.684	7:55	1.901	1.116	1.116	0.34
1/23/2018	3:40	3.2	18:35	5.8	4.5	4:00	4.4	18:35	7.0	6.0	4:15	0.617	18:35	2.247	1.366	1.366	0.79
1/24/2018	3:40	4.5	18:40	5.4	4.9	21:35	6.0	18:40	6.8	6.4	3:40	1.345	18:40	1.986	1.603	1.603	0.51
1/25/2018	23:50	4.0	12:25	5.1	4.3	4:40	5.3	12:25	6.6	5.9	3:55	1.017	12:25	1.750	1.249	1.249	0.14
1/26/2018	3:25	3.5	9:35	4.8	4.0	3:00	4.8	9:35	6.5	5.6	3:15	0.765	9:35	1.574	1.076	1.076	0.36
1/27/2018	0:35	3.8	11:45	6.0	4.4	0:30	5.3	11:45	7.2	6.1	0:30	0.942	11:45	2.384	1.336	1.336	0.61
1/28/2018	6:40	3.7	10:40	4.4	4.0	4:35	5.0	12:15	6.3	5.7	5:40	0.844	12:15	1.368	1.099	1.099	0.07
1/29/2018	4:05	3.3	16:40	6.5	4.4	3:40	4.7	15:15	7.5	6.1	3:40	0.668	16:35	2.735	1.392	1.392	0.90
1/30/2018	23:55	3.6	8:40	4.7	4.0	23:45	5.0	8:35	6.6	5.8	23:50	0.825	8:35	1.571	1.102	1.102	0.00
1/31/2018	3:35	3.3	8:55	4.2	3.7	2:45	4.7	8:55	6.4	5.6	3:35	0.671	8:55	1.304	0.932	0.932	0.00
ReportAvg				4.0					5.6					1.066			
ReportTotal															33.05	8.79	

ADS Environmental Services

Pipe Height: 18.00

Date	REN_MH2252\mp1\DFINAL (inches)					REN_MH2252\mp1\VFINAL (feet/sec)					REN_MH2252\mp1\QFINAL (MGD - Total MG)					REN_RG\mp1\RAIN (inches)	
	Time	Min.	Time	Max.	Average	Time	Min.	Time	Max.	Average	Time	Min.	Time	Max.	Average	Total	Total
2/1/2018	3:40	3.0	3:35	4.6	3.6	2:45	4.5	21:05	6.5	5.7	3:40	0.569	3:35	1.467	0.946	0.946	0.66
2/2/2018	4:15	3.3	8:50	4.1	3.7	2:55	5.0	6:55	6.4	5.9	2:55	0.745	8:45	1.250	1.000	1.000	0.04
2/3/2018	5:25	3.1	12:50	4.1	3.6	3:30	4.9	9:45	6.4	5.8	5:15	0.638	12:50	1.223	0.949	0.949	0.31
2/4/2018	5:55	3.1	13:20	4.1	3.6	5:00	5.0	11:00	6.3	5.7	5:00	0.639	13:15	1.232	0.936	0.936	0.02
2/5/2018	3:45	2.9	15:20	3.9	3.4	1:50	4.8	12:45	6.1	5.6	4:35	0.596	15:20	1.083	0.852	0.852	0.04
2/6/2018	3:20	2.8	21:00	3.8	3.4	3:15	4.6	19:25	5.9	5.3	3:15	0.526	19:25	1.011	0.805	0.805	0.00
2/7/2018	2:55	2.8	21:00	4.0	3.4	1:45	4.3	6:50	5.7	5.1	1:45	0.513	21:05	1.053	0.789	0.789	0.00
2/8/2018	3:15	2.8	20:55	4.0	3.5	2:25	4.2	20:55	5.7	5.1	3:25	0.486	20:55	1.102	0.805	0.805	0.09
2/9/2018	4:35	3.1	12:35	4.0	3.6	4:40	4.2	12:35	5.7	5.2	4:40	0.540	12:35	1.100	0.856	0.856	0.01
2/10/2018	6:45	3.1	11:45	4.2	3.7	7:10	4.4	11:45	5.9	5.3	6:45	0.601	11:45	1.219	0.894	0.894	0.01
2/11/2018	6:40	3.0	11:20	4.2	3.6	6:45	4.1	11:20	5.9	5.2	6:45	0.530	11:20	1.191	0.875	0.875	0.00
2/12/2018	3:45	3.0	20:30	3.7	3.4	0:30	4.3	19:35	5.4	4.8	3:45	0.560	19:35	0.919	0.720	0.720	0.00
2/13/2018	4:25	2.7	17:50	3.7	3.3	4:35	3.7	17:25	5.2	4.7	4:35	0.410	17:55	0.875	0.670	0.670	0.17
2/14/2018	4:15	2.8	19:50	3.7	3.4	4:35	3.9	21:20	5.4	4.8	4:10	0.458	21:20	0.922	0.714	0.714	0.15
2/15/2018	3:30	2.8	14:15	3.9	3.3	4:35	3.8	14:10	5.7	4.7	4:35	0.445	14:10	1.023	0.684	0.684	0.00
2/16/2018	2:15	2.6	20:00	3.5	3.2	1:25	3.7	8:25	5.2	4.6	2:10	0.387	20:10	0.814	0.648	0.648	0.15
2/17/2018	2:50	2.6	12:15	4.4	3.6	2:55	3.6	12:15	6.1	5.1	2:55	0.374	12:15	1.319	0.834	0.834	0.32
2/18/2018	5:15	2.7	10:45	3.9	3.4	5:35	3.7	11:25	5.5	4.8	5:05	0.404	11:25	0.974	0.717	0.717	0.01
2/19/2018	3:35	2.6	20:00	3.8	3.3	3:35	3.5	12:25	5.3	4.7	3:35	0.369	12:25	0.894	0.685	0.685	0.00
2/20/2018	4:35	2.7	20:40	3.7	3.2	3:50	3.6	20:45	5.4	4.6	3:50	0.388	20:45	0.923	0.651	0.651	0.00
2/21/2018	4:55	2.8	19:45	3.8	3.3	5:25	3.8	19:45	5.5	4.8	4:45	0.438	19:45	0.958	0.709	0.709	0.00
2/22/2018	4:50	2.9	19:00	3.6	3.3	4:50	4.0	19:00	5.2	4.8	4:50	0.473	19:00	0.838	0.699	0.699	0.07
2/23/2018	5:30	2.8	10:10	3.6	3.2	1:05	3.7	10:10	5.2	4.7	5:30	0.418	10:10	0.831	0.666	0.666	0.01
2/24/2018	3:35	2.7	11:55	3.9	3.3	3:25	3.7	11:55	5.6	4.8	3:25	0.405	11:55	1.038	0.719	0.719	0.13
2/25/2018	2:05	2.8	11:00	3.9	3.4	3:20	3.9	11:00	5.6	4.9	3:20	0.448	11:00	1.019	0.763	0.763	0.11
2/26/2018	1:20	2.8	20:05	3.7	3.2	1:35	3.8	20:05	5.3	4.6	1:35	0.424	20:05	0.902	0.652	0.652	0.00
2/27/2018	4:00	2.7	20:30	3.8	3.2	1:25	3.8	20:25	5.5	4.7	5:05	0.426	20:25	0.959	0.660	0.660	0.19
2/28/2018	5:10	2.7	18:55	4.0	3.3	5:10	3.8	18:55	5.6	4.8	5:10	0.411	18:55	1.053	0.708	0.708	0.35
ReportAvg	3.4					5.0					0.772						
ReportTotal																21.61	2.84

ADS Environmental Services

Pipe Height: 18.00

Date	REN_MH2252\mp1\DFINAL (inches)					REN_MH2252\mp1\VFINAL (feet/sec)					REN_MH2252\mp1\QFINAL (MGD - Total MG)					REN_RG\mp1\RAIN (inches)	
	Time	Min.	Time	Max.	Average	Time	Min.	Time	Max.	Average	Time	Min.	Time	Max.	Average	Total	Total
3/1/2018	4:30	2.7	19:25	3.6	3.2	4:25	3.7	19:50	5.3	4.6	4:25	0.400	19:50	0.846	0.645	0.645	0.01
3/2/2018	3:30	2.7	8:10	3.6	3.3	1:55	3.6	7:45	5.2	4.6	1:55	0.383	8:10	0.811	0.653	0.653	0.07
3/3/2018	4:15	2.6	10:55	3.8	3.2	4:05	3.5	11:20	5.4	4.6	4:05	0.356	11:20	0.945	0.655	0.655	0.00
3/4/2018	3:45	2.6	11:35	3.8	3.3	3:50	3.5	11:10	5.5	4.7	3:50	0.362	11:10	0.960	0.702	0.702	0.12
3/5/2018	2:25	2.7	20:15	3.7	3.2	2:05	3.7	20:20	5.3	4.6	2:05	0.388	20:20	0.871	0.648	0.648	0.00
3/6/2018	1:35	2.7	20:30	3.7	3.2	1:15	3.6	20:35	5.3	4.6	1:15	0.395	20:35	0.897	0.638	0.638	0.00
3/7/2018	5:15	2.7	16:35	4.9	3.2	1:35	3.8	16:35	6.4	4.7	1:35	0.413	16:35	1.602	0.662	0.662	0.03
3/8/2018	4:55	2.7	21:30	4.4	3.3	3:40	3.7	21:10	5.8	4.7	3:40	0.414	21:30	1.241	0.690	0.690	0.37
3/9/2018	4:40	2.7	12:05	3.6	3.3	5:05	3.7	12:10	5.2	4.6	4:40	0.410	12:10	0.824	0.655	0.655	0.00
3/10/2018	4:25	2.6	11:35	3.8	3.2	4:20	3.5	11:40	5.4	4.6	4:20	0.348	11:40	0.938	0.643	0.643	0.00
3/11/2018	4:15	2.6	11:15	3.8	3.3	2:55	3.5	11:15	5.4	4.7	4:15	0.364	11:15	0.938	0.675	0.675	0.00
3/12/2018	4:00	2.6	10:00	3.9	3.2	4:05	3.5	10:05	5.6	4.7	4:05	0.366	10:05	1.017	0.670	0.670	0.00
3/13/2018	4:05	2.7	18:45	3.9	3.3	1:30	3.8	18:45	5.6	4.7	4:20	0.421	18:45	1.019	0.686	0.686	0.31
3/14/2018	2:55	2.7	19:40	3.7	3.3	3:50	3.7	19:40	5.4	4.7	3:40	0.394	19:40	0.930	0.680	0.680	0.04
3/15/2018	3:40	2.7	19:45	3.6	3.2	3:45	3.6	19:40	5.3	4.6	3:45	0.375	19:40	0.866	0.633	0.633	0.00
3/16/2018	2:50	2.6	8:55	3.5	3.2	3:15	3.6	8:55	5.2	4.5	3:15	0.366	8:55	0.820	0.621	0.621	0.00
3/17/2018	5:05	2.5	10:05	3.8	3.2	3:45	3.4	10:05	5.5	4.6	3:45	0.339	10:05	0.985	0.665	0.665	0.00
3/18/2018	1:45	2.6	11:10	3.8	3.3	5:15	3.5	11:10	5.5	4.7	5:15	0.365	11:10	0.986	0.694	0.694	0.00
3/19/2018	3:25	2.7	8:55	3.9	3.2	0:55	3.6	9:00	5.5	4.6	0:55	0.380	9:00	0.981	0.636	0.636	0.00
3/20/2018	2:45	2.5	20:10	3.7	3.2	2:15	3.5	20:10	5.4	4.6	2:15	0.355	20:10	0.926	0.637	0.637	0.00
3/21/2018	4:00	2.7	19:25	3.6	3.2	2:35	3.7	19:20	5.3	4.6	2:35	0.396	19:20	0.865	0.649	0.649	0.10
3/22/2018	4:20	2.7	7:30	4.0	3.3	4:15	3.7	7:45	5.6	4.8	4:15	0.398	7:45	1.020	0.721	0.721	0.48
3/23/2018	4:00	2.7	9:45	4.1	3.4	4:10	3.7	9:40	5.8	4.8	4:10	0.407	9:40	1.124	0.734	0.734	0.31
3/24/2018	3:00	2.7	10:10	3.9	3.4	2:30	3.7	10:30	5.5	4.7	2:55	0.397	10:10	0.986	0.709	0.709	0.28
3/25/2018	3:50	2.6	9:40	3.8	3.3	3:40	3.5	11:40	5.4	4.6	3:45	0.350	11:40	0.926	0.679	0.679	0.01
3/26/2018	3:05	2.5	19:20	3.7	3.3	2:35	3.4	19:30	5.4	4.6	2:35	0.341	19:30	0.905	0.666	0.666	0.17
3/27/2018	3:05	2.5	20:05	3.6	3.2	2:15	3.5	19:55	5.3	4.5	2:15	0.347	19:55	0.872	0.621	0.621	0.02
3/28/2018	1:50	2.5	19:55	3.7	3.2	1:50	3.4	20:00	5.3	4.5	1:50	0.335	20:00	0.895	0.615	0.615	0.01
3/29/2018	3:20	2.6	19:50	3.7	3.2	3:00	3.5	19:50	5.4	4.5	3:00	0.357	19:50	0.914	0.633	0.633	0.00
3/30/2018	3:50	2.5	18:35	3.5	3.1	2:40	3.5	18:35	5.1	4.5	2:45	0.346	18:35	0.785	0.604	0.604	0.00
3/31/2018	3:25	2.5	10:30	3.8	3.2	3:30	3.4	10:30	5.5	4.6	3:30	0.326	10:30	0.977	0.650	0.650	0.00
ReportAvg					3.2					4.6					0.660		
ReportTotal															20.47	2.33	

ADS Environmental Services

Pipe Height: 18.00

Date	REN_MH2252\mp1\DFINAL (inches)					REN_MH2252\mp1\VFINAL (feet/sec)					REN_MH2252\mp1\QFINAL (MGD - Total MG)					REN_RG\mp1\RAIN (inches)	
	Time	Min.	Time	Max.	Average	Time	Min.	Time	Max.	Average	Time	Min.	Time	Max.	Average	Total	Total
4/1/2018	5:15	2.5	10:10	3.9	3.2	5:55	3.4	10:10	5.5	4.7	5:55	0.341	10:10	0.992	0.675	0.675	0.10
4/2/2018	2:20	2.6	20:10	3.6	3.2	4:30	3.6	20:10	5.3	4.6	4:30	0.377	20:10	0.874	0.621	0.621	0.00
4/3/2018	2:20	2.6	20:25	3.7	3.2	4:15	3.5	20:25	5.4	4.6	4:15	0.350	20:25	0.919	0.631	0.631	0.00
4/4/2018	2:15	2.6	18:30	3.9	3.4	3:40	3.5	18:30	5.6	4.9	3:40	0.371	18:30	1.010	0.752	0.752	0.39
4/5/2018	2:15	2.7	18:50	4.1	3.4	2:15	3.8	18:50	5.8	4.9	2:15	0.408	18:50	1.119	0.745	0.745	0.25
4/6/2018	4:30	2.8	14:30	3.5	3.3	3:55	4.1	14:30	5.2	4.8	4:30	0.474	14:30	0.822	0.699	0.699	0.00
4/7/2018	2:40	2.7	8:40	4.8	3.9	2:45	3.8	8:40	6.4	5.4	2:45	0.409	8:40	1.569	1.013	1.013	0.88
4/8/2018	2:55	3.1	9:40	4.5	3.8	3:00	4.3	10:35	6.2	5.4	3:00	0.568	10:35	1.384	0.961	0.961	0.45
4/9/2018	2:45	3.0	6:35	3.8	3.4	23:50	4.1	19:40	5.4	4.8	3:50	0.508	6:35	0.922	0.737	0.737	0.00
4/10/2018	3:00	2.8	8:20	3.7	3.4	2:15	3.8	19:45	5.4	4.8	2:40	0.441	8:20	0.917	0.722	0.722	0.23
4/11/2018	2:35	2.7	19:35	3.9	3.4	2:35	3.7	19:25	5.5	4.7	2:35	0.401	19:35	0.971	0.703	0.703	0.31
4/12/2018	2:00	2.8	19:50	3.7	3.4	2:40	3.9	20:05	5.3	4.8	2:40	0.451	19:40	0.887	0.705	0.705	0.11
4/13/2018	1:30	2.8	15:10	4.3	3.6	1:10	3.7	19:20	5.9	5.0	1:10	0.419	15:10	1.211	0.826	0.826	0.51
4/14/2018	3:10	3.5	19:25	5.6	4.6	4:50	4.8	19:25	7.0	6.0	4:50	0.756	19:25	2.121	1.437	1.437	1.52
4/15/2018	23:55	3.9	9:30	5.3	4.8	23:15	5.3	8:50	6.8	6.2	23:55	0.998	10:25	1.860	1.545	1.545	0.21
4/16/2018	3:20	3.6	19:35	5.1	4.4	4:20	5.0	20:25	6.7	6.0	4:00	0.851	19:35	1.744	1.302	1.302	0.71
4/17/2018	23:50	3.5	7:20	4.7	4.1	22:35	5.0	7:35	6.4	5.6	23:50	0.774	7:35	1.517	1.078	1.078	0.01
4/18/2018	23:55	3.1	8:45	4.3	3.7	23:50	4.3	8:45	6.1	5.2	23:50	0.581	8:45	1.298	0.890	0.890	0.12
4/19/2018	23:55	3.0	7:15	4.3	3.5	1:40	4.1	7:10	6.4	5.0	1:40	0.515	7:10	1.312	0.786	0.786	0.00
4/20/2018	2:50	2.7	10:10	4.2	3.3	1:55	3.9	9:40	6.0	4.8	1:55	0.430	9:55	1.218	0.708	0.708	0.00
4/21/2018	3:50	2.7	9:10	3.8	3.3	3:35	3.9	10:20	5.5	4.8	3:35	0.414	9:35	0.971	0.701	0.701	0.05
4/22/2018	3:05	2.7	11:05	3.8	3.3	5:05	3.9	8:40	5.5	4.8	5:05	0.417	10:55	0.946	0.704	0.704	0.00
ReportAvg	3.6					5.1					0.861						
ReportTotal																18.94	5.85

REN_MH2999

Located At: 3431 Shattuck Ave S (see attached site report for details)
Monitoring Period: December 22, 2017 – April 22, 2018
Pipe Dimensions: 8"
Finalized Silt Level: 0 mm

Site Data Characteristics: This site is located in a sanitary sewer pipe. The scattergraph indicates site operated in free flow conditions. The site did not surcharge during the monitoring period. The dry weather data plots above the Froude =1 curve indicating supercritical flow.

Site Data Bias & Editing: The depth and velocity measurements recorded by the flow monitor were consistent with field confirmations conducted to date and supported the relative accuracy of the flow monitor at this location. The finalized depth data utilized the upward ultrasonic sensor.

Site Data Uptime: The data uptime achieved during the monitoring period is provided in the table below. Based upon the quality and consistency of the observed flow depth and velocity data, the Continuity equation was used to calculate the flow rate for the monitoring period.

Entity	Percentage Uptime	
	Raw	Final
Depth (in)	100%	100%
Velocity (f/s)	100%	100%
Quantity (mgd)	100%	100%

Site Data Summary: The average flow depth, velocity, and quantity data observed during the monitoring period along with observed minimum and maximum data, are provided in the following table. The minimum and maximum rates recorded in the tables are based on 5-minute data intervals.

Item	Depth (in)	Velocity (f/s)	Quantity (mgd)	% Full
Minimum	1.28	3.51	0.087	16%
Maximum	3.28	7.12	0.609	41%
Average	1.81	5.58	0.218	23%

Renton.Carollo.I&I.WA17

Flow Monitoring Site Report



Site Name

REN_MH2999

Site Address /Location:	3431 Shattuck Ave S		
Site Access Details:	Located in roadway at end of residential neighborhood.	Latitude:	47.448386°
		Longitude:	-122.212824°

Monitor Series	Location Type
TRITON+	Temporary
Pipe Size (H x W)	Pipe Shape
8.00" x 8.00"	Circular

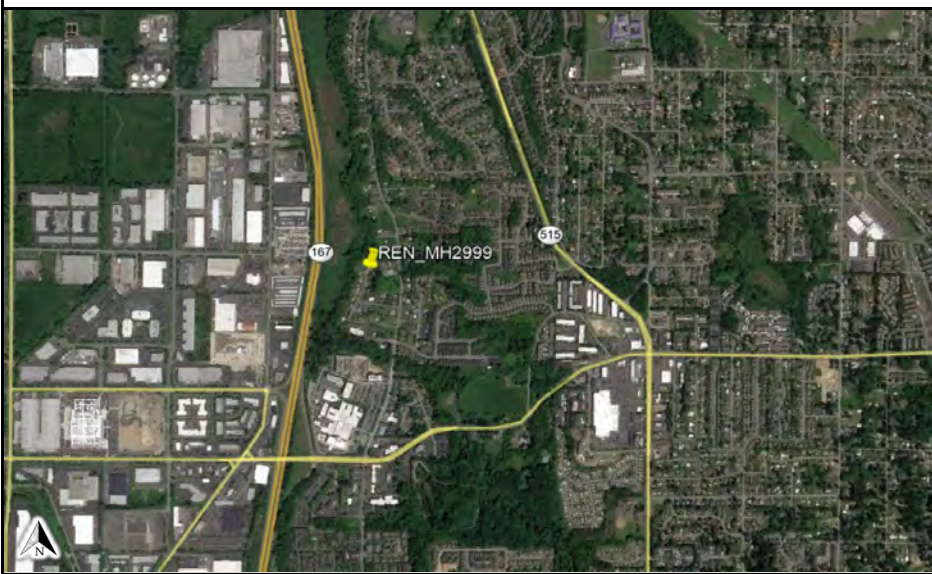

Manhole #	System Characteristics
MH2999	Other
Access	Traffic
Drive	Medium



Installation Information	
Installation Date:	Installation Type:
12.19.17	Doppler Standard Ring and Crank
Monitoring Location (Sensors):	Monitor Location:
Upstream 0-5 FT	Manhole
Sensors / Devices:	Pressure Sensor Range (psi)
Peak Combo (CS4), Smart Depth (CS5)	0 - 5 psi

Installation Confirmation:	
Confirmation Time:	Pipe Size (HxW)
9:22:00 AM	8.00" x 8.00"
Depth of Flow (Wet DOF) (in)	Range (Air DOF) (in)
~2.63"	
Downlooker Physical Offset (in)	Measurement Confidence (in)
1.25"	0.25"
Peak Velocity (fps)	Velocity Sensor Offset (in)
~7.5 FPS	
Silt (in)	Silt Type
0	

Hydraulic Comments:
Fast, low flow

Manhole / Pipe Information:	
Manhole Depth (Approx. FT):	Manhole Configuration
~8'	Single
Manhole Material:	Manhole Condition:
Concrete	Good
Manhole Opening Diameter (in)	Manhole Diameter (Approx.):
20"	20"
Manhole Cover	Manhole Frame
Unbolted	Normal
Active Drop Connections	Air Quality:
No	Normal
Pipe Material	Pipe Condition:
Concrete	Good

Communication Information:	
Communication Type	Antenna Location
Wireless	Manhole Pick / Vent Hole

Additional Site Info. / Comments:
Traffic control required.

ADS Project Name:	Renton.Carollo.I&I.WA17
ADS Project Number:	22275.11.325

Additional Photos

Upstream



Downstream



Side Inlet



Top Down



Location



Location

- Flow Direction
- ⊗ Monitoring Point

HYDROGRAPH REPORT

REN_MH2999

Flow Monitor
REN_MH2999

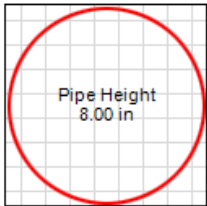

Report Period
12/22/2017
To
4/22/2018

Legend
— Depth
— Velocity
— Rain

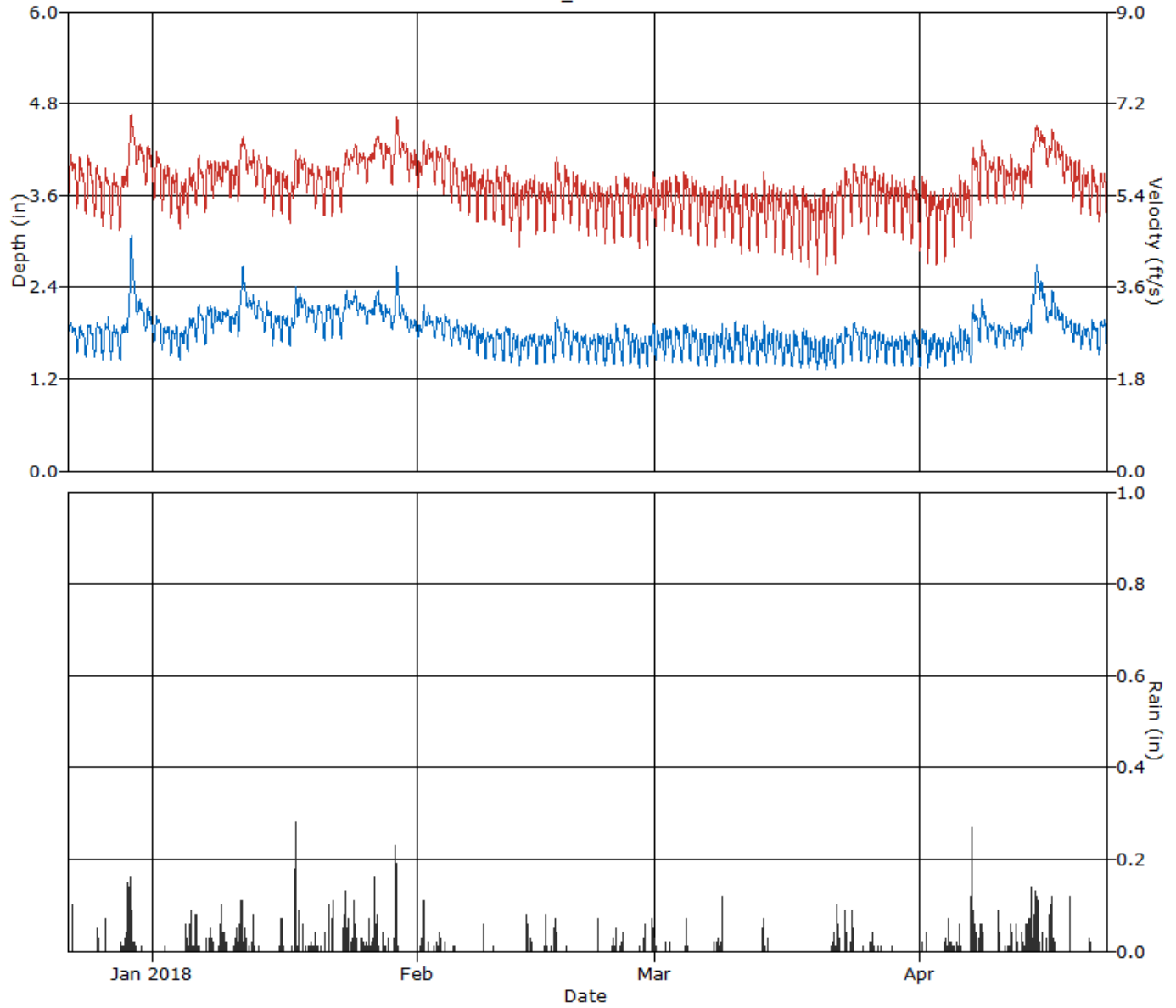

HYDROGRAPH REPORT

REN_MH2999

Flow Monitor
REN_MH2999

Pipe Height
8.00 in.

Report Period
12/22/2017
To
4/22/2018

Legend
— Quantity
— Rain

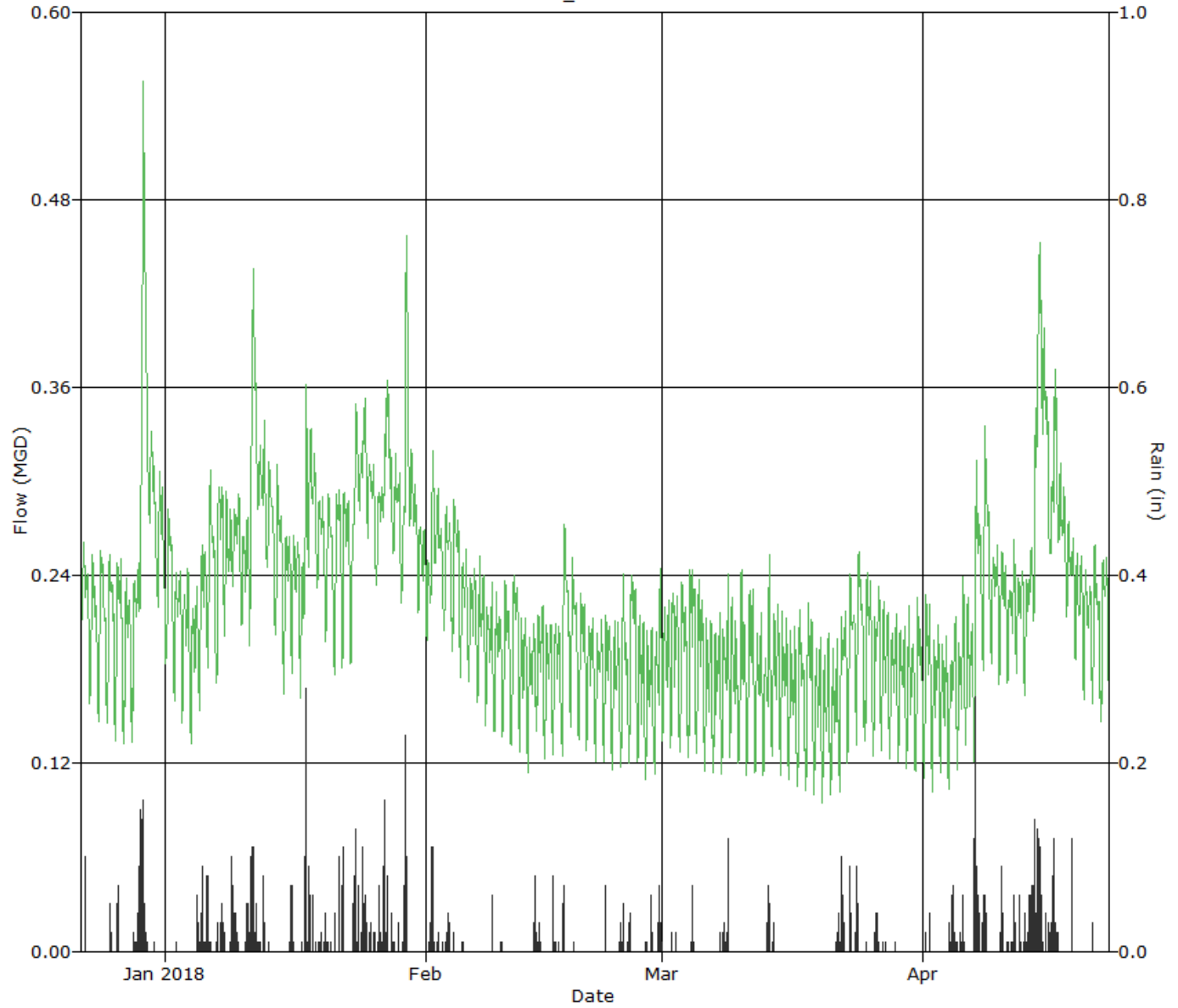

SCATTERGRAPH REPORT

REN_MH2999

Flow Monitor
REN_MH2999

Pipe Height
8.00 in

Report Period
12/22/2017
To
4/22/2018

Legend
○ Depth - Velocity
--- Iso-Q™
--- Silt
▼ Min-Max Depth

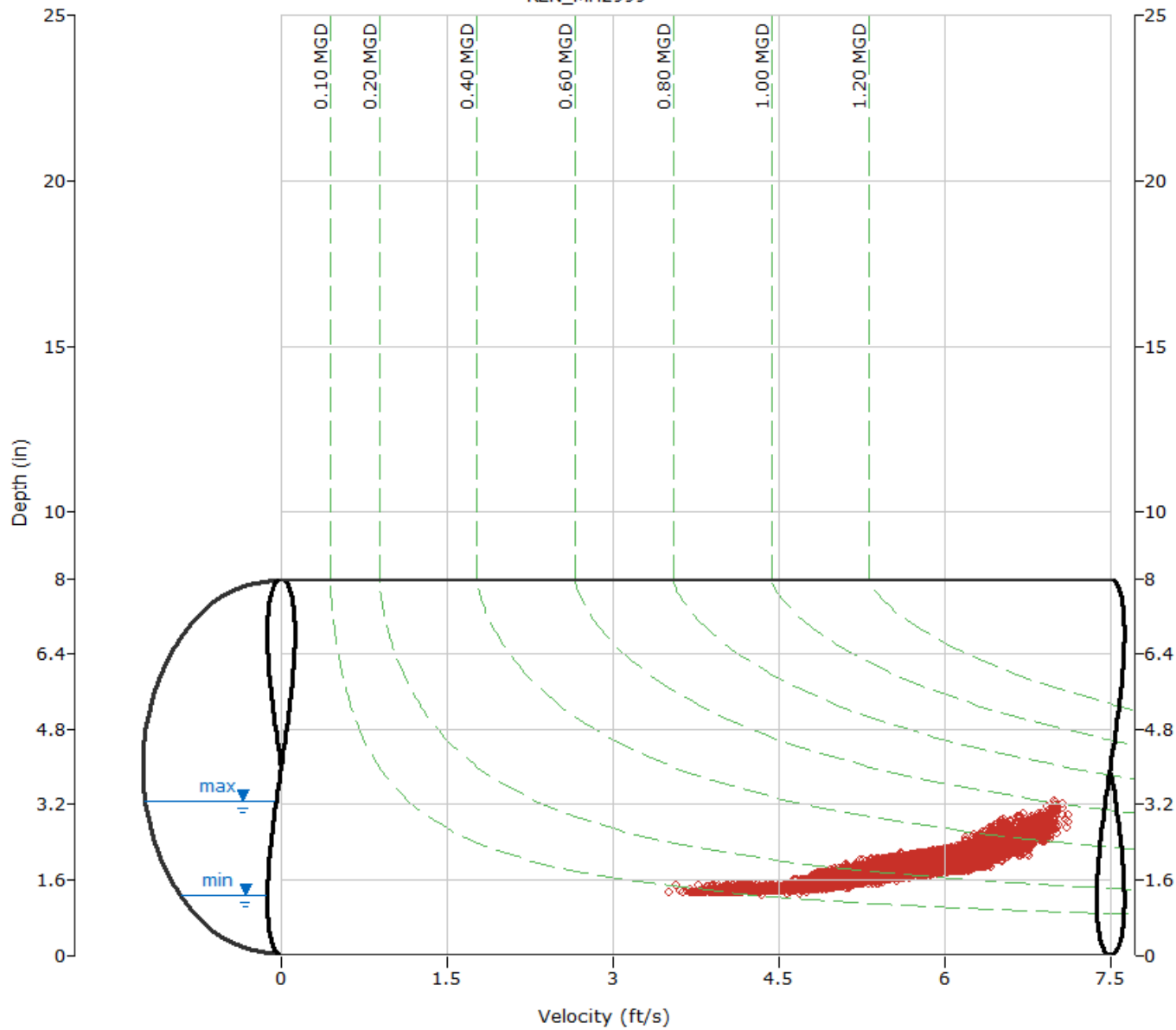

ADS Environmental Services

Pipe Height: 8.00

Date	REN_MH2999\mp1\DFINAL (inches)					REN_MH2999\mp1\VFINAL (feet/sec)					REN_MH2999\mp1\QFINAL (MGD - Total MG)					REN_RG\mp1\RAIN (inches)	
	Time	Min.	Time	Max.	Average	Time	Min.	Time	Max.	Average	Time	Min.	Time	Max.	Average	Total	Total
12/22/2017	1:20	1.6	13:25	2.2	1.8	3:00	5.1	9:35	6.8	5.9	1:20	0.171	11:30	0.335	0.232	0.232	0.10
12/23/2017	5:25	1.5	9:55	2.1	1.8	5:25	5.0	11:05	6.5	5.7	5:25	0.147	9:55	0.310	0.211	0.211	0.00
12/24/2017	5:10	1.4	10:45	2.2	1.8	3:40	4.8	10:45	6.5	5.7	5:05	0.136	10:45	0.326	0.210	0.210	0.00
12/25/2017	5:45	1.5	12:10	2.2	1.8	5:45	4.8	12:10	6.4	5.6	5:45	0.136	12:10	0.317	0.209	0.209	0.14
12/26/2017	4:35	1.4	18:30	2.2	1.8	4:35	4.7	13:00	6.3	5.4	4:35	0.130	18:30	0.314	0.204	0.204	0.17
12/27/2017	3:55	1.4	19:50	2.1	1.7	3:05	4.6	19:50	6.3	5.4	4:00	0.128	19:50	0.291	0.195	0.195	0.00
12/28/2017	2:15	1.4	9:45	2.1	1.8	4:10	4.6	20:10	6.2	5.5	4:10	0.127	20:10	0.288	0.204	0.204	0.25
12/29/2017	0:45	1.7	10:40	3.3	2.4	1:05	5.1	11:55	7.1	6.4	1:05	0.185	10:40	0.609	0.383	0.383	1.57
12/30/2017	23:35	1.9	0:25	2.6	2.1	5:30	5.8	16:55	6.7	6.2	23:35	0.250	12:05	0.401	0.298	0.298	0.02
12/31/2017	3:05	1.8	10:40	2.4	2.0	5:05	5.4	10:40	6.6	6.0	5:20	0.206	10:40	0.371	0.260	0.260	0.00
ReportAvg	1.9					5.8					0.241						
ReportTotal																2.407	2.25

ADS Environmental Services

Pipe Height: 8.00

Date	REN_MH2999\mp1\DFINAL (inches)					REN_MH2999\mp1\VFINAL (feet/sec)					REN_MH2999\mp1\QFINAL (MGD - Total MG)					REN_RG\mp1\RAIN (inches)	
	Time	Min.	Time	Max.	Average	Time	Min.	Time	Max.	Average	Time	Min.	Time	Max.	Average	Total	Total
1/1/2018	6:35	1.6	10:30	2.4	1.9	6:05	5.1	11:25	6.8	5.9	7:20	0.171	10:30	0.381	0.238	0.238	0.00
1/2/2018	2:50	1.5	6:55	2.1	1.8	1:50	4.9	6:55	6.4	5.7	2:50	0.147	6:55	0.296	0.215	0.215	0.01
1/3/2018	2:50	1.5	18:45	2.1	1.8	23:00	4.9	18:45	6.4	5.6	2:40	0.141	18:45	0.292	0.206	0.206	0.00
1/4/2018	3:35	1.4	9:55	2.1	1.7	3:50	4.6	8:35	6.4	5.4	3:50	0.129	9:55	0.292	0.192	0.192	0.09
1/5/2018	2:10	1.5	20:05	2.2	1.8	4:05	4.6	16:05	6.3	5.5	2:20	0.134	20:05	0.312	0.221	0.221	0.42
1/6/2018	2:50	1.6	11:05	2.4	2.0	3:00	4.9	9:15	6.3	5.7	2:50	0.157	11:05	0.359	0.247	0.247	0.24
1/7/2018	3:10	1.6	12:15	2.5	2.0	4:25	4.9	10:20	6.6	5.7	5:10	0.154	12:15	0.393	0.249	0.249	0.38
1/8/2018	2:40	1.7	8:45	2.3	2.0	2:35	5.0	11:45	6.4	5.8	2:35	0.179	8:45	0.345	0.254	0.254	0.14
1/9/2018	3:25	1.8	6:55	2.4	2.0	3:30	5.3	6:55	6.4	5.9	3:30	0.209	6:55	0.362	0.268	0.268	0.46
1/10/2018	4:10	1.7	22:35	2.2	2.0	2:50	5.1	9:20	6.3	5.7	2:55	0.181	22:35	0.318	0.247	0.247	0.22
1/11/2018	2:40	1.7	15:10	3.0	2.3	2:10	5.2	13:05	6.7	6.1	2:35	0.181	15:10	0.515	0.331	0.331	1.04
1/12/2018	23:55	2.0	19:10	2.7	2.2	2:40	5.6	19:55	6.5	6.0	23:55	0.261	19:10	0.421	0.302	0.302	0.20
1/13/2018	4:25	1.9	11:35	2.4	2.1	4:10	5.3	12:25	6.5	5.9	4:25	0.221	12:25	0.372	0.277	0.277	0.02
1/14/2018	5:50	1.7	10:05	2.5	2.0	2:50	5.0	10:05	6.5	5.7	5:50	0.176	10:05	0.392	0.254	0.254	0.00
1/15/2018	4:05	1.6	19:40	2.2	1.9	1:55	4.8	19:40	6.4	5.6	2:50	0.155	19:40	0.320	0.232	0.232	0.04
1/16/2018	3:35	1.6	20:45	2.2	1.9	3:35	4.8	7:15	6.3	5.6	3:35	0.155	20:45	0.318	0.232	0.232	0.26
1/17/2018	3:40	1.6	19:05	2.8	2.0	3:10	4.6	19:05	6.6	5.6	3:10	0.148	19:05	0.462	0.246	0.246	0.79
1/18/2018	1:30	1.9	9:00	2.7	2.2	1:55	5.3	9:00	6.4	6.0	1:35	0.229	9:00	0.421	0.297	0.297	0.40
1/19/2018	3:20	1.9	8:30	2.5	2.1	3:15	5.1	18:45	6.5	5.8	3:15	0.205	18:45	0.381	0.267	0.267	0.10
1/20/2018	3:10	1.7	10:30	2.4	2.0	2:15	4.9	10:30	6.3	5.6	3:10	0.180	10:30	0.349	0.253	0.253	0.10
1/21/2018	6:00	1.6	9:45	2.4	2.0	4:20	4.8	11:35	6.4	5.6	2:50	0.161	9:45	0.364	0.249	0.249	0.16
1/22/2018	2:20	1.6	10:40	2.5	2.0	4:30	4.8	7:45	6.4	5.7	2:20	0.162	10:40	0.373	0.255	0.255	0.34
1/23/2018	2:15	1.7	18:45	2.7	2.1	3:55	4.8	20:10	6.5	5.8	3:55	0.165	18:45	0.419	0.274	0.274	0.79
1/24/2018	4:30	2.0	6:30	2.7	2.2	3:20	5.6	19:25	6.6	6.2	4:30	0.258	6:30	0.443	0.314	0.314	0.51
1/25/2018	2:45	2.0	20:35	2.6	2.1	3:35	5.6	20:35	6.6	6.1	2:40	0.250	20:35	0.425	0.294	0.294	0.14
1/26/2018	4:30	1.9	23:20	2.4	2.1	3:10	5.4	13:00	6.5	6.0	3:35	0.218	23:20	0.374	0.277	0.277	0.36
1/27/2018	0:05	2.0	10:50	2.6	2.2	0:10	5.9	20:55	6.9	6.4	0:10	0.261	10:50	0.440	0.323	0.323	0.61
1/28/2018	5:20	1.9	10:05	2.5	2.0	5:30	5.7	10:05	6.7	6.2	5:20	0.236	10:05	0.398	0.282	0.282	0.07
1/29/2018	2:45	1.8	16:50	3.0	2.2	3:15	5.3	18:05	7.1	6.3	3:15	0.204	16:55	0.540	0.317	0.317	0.90
1/30/2018	23:35	1.9	16:20	2.4	2.0	23:15	6.0	22:35	6.8	6.3	23:30	0.243	16:20	0.389	0.287	0.287	0.00
1/31/2018	4:00	1.8	6:30	2.3	1.9	3:30	5.4	6:30	6.7	6.0	3:45	0.200	6:30	0.363	0.249	0.249	0.00
ReportAvg	2.0					5.9					0.263						
ReportTotal																8.150	8.79

ADS Environmental Services

Pipe Height: 8.00

Date	REN_MH2999\mp1\DFINAL (inches)					REN_MH2999\mp1\VFINAL (feet/sec)					REN_MH2999\mp1\QFINAL (MGD - Total MG)					REN_RG\mp1\RAIN (inches)	
	Time	Min.	Time	Max.	Average	Time	Min.	Time	Max.	Average	Time	Min.	Time	Max.	Average	Total	Total
2/1/2018	3:40	1.7	21:55	2.5	1.9	4:05	5.3	22:50	6.9	6.0	3:40	0.180	21:55	0.400	0.246	0.246	0.66
2/2/2018	3:00	1.8	8:15	2.4	2.0	23:00	5.8	11:00	6.8	6.2	3:00	0.223	8:15	0.373	0.265	0.265	0.04
2/3/2018	3:45	1.7	10:20	2.3	1.9	4:10	5.3	12:55	6.7	6.0	4:10	0.187	10:20	0.352	0.249	0.249	0.31
2/4/2018	3:50	1.7	20:35	2.3	1.9	4:30	5.3	11:05	6.7	6.0	3:05	0.186	20:35	0.352	0.247	0.247	0.02
2/5/2018	3:40	1.6	20:55	2.3	1.8	2:50	5.0	12:55	6.6	5.8	3:15	0.164	20:55	0.338	0.224	0.224	0.04
2/6/2018	3:30	1.6	17:50	2.1	1.8	1:45	4.9	17:50	6.5	5.7	1:45	0.160	17:50	0.307	0.217	0.217	0.00
2/7/2018	2:45	1.5	10:25	2.2	1.8	3:30	4.8	10:25	6.5	5.6	3:00	0.147	10:25	0.330	0.209	0.209	0.00
2/8/2018	2:40	1.5	18:20	2.1	1.7	2:45	4.7	18:20	6.4	5.5	2:45	0.136	18:20	0.300	0.197	0.197	0.09
2/9/2018	3:20	1.4	8:55	2.0	1.7	2:15	4.8	8:00	6.3	5.5	3:15	0.132	8:55	0.270	0.194	0.194	0.01
2/10/2018	4:00	1.4	10:25	2.1	1.7	5:20	4.8	10:20	6.4	5.5	3:55	0.130	10:25	0.298	0.194	0.194	0.01
2/11/2018	5:20	1.4	13:50	2.1	1.7	3:15	4.6	16:50	6.3	5.5	5:05	0.125	13:50	0.291	0.197	0.197	0.00
2/12/2018	3:30	1.4	8:55	2.0	1.6	2:20	4.4	21:30	6.2	5.3	4:25	0.118	8:55	0.275	0.178	0.178	0.00
2/13/2018	3:05	1.4	20:55	1.9	1.6	4:30	4.3	20:55	6.2	5.3	2:50	0.111	20:55	0.253	0.173	0.173	0.17
2/14/2018	4:35	1.4	7:35	2.0	1.7	4:30	4.6	7:35	6.3	5.4	4:35	0.124	7:35	0.277	0.189	0.189	0.15
2/15/2018	2:55	1.4	21:20	1.9	1.6	2:45	4.4	21:20	6.2	5.3	2:50	0.115	21:20	0.256	0.178	0.178	0.00
2/16/2018	2:55	1.4	10:00	2.0	1.7	1:20	4.5	17:35	6.3	5.3	1:20	0.119	10:00	0.272	0.181	0.181	0.15
2/17/2018	3:25	1.4	10:45	2.2	1.8	3:25	4.5	11:30	6.6	5.6	3:25	0.117	10:45	0.328	0.211	0.211	0.32
2/18/2018	5:00	1.5	9:25	2.1	1.8	5:00	4.9	9:25	6.3	5.6	5:00	0.139	9:25	0.296	0.206	0.206	0.01
2/19/2018	2:55	1.4	21:25	2.0	1.7	2:55	4.7	21:25	6.3	5.4	2:55	0.127	21:25	0.286	0.191	0.191	0.00
2/20/2018	3:35	1.4	19:45	1.9	1.7	3:35	4.5	21:00	6.3	5.4	3:35	0.120	19:45	0.260	0.183	0.183	0.00
2/21/2018	3:15	1.4	21:25	1.9	1.6	4:05	4.3	21:25	6.2	5.3	3:10	0.114	21:25	0.260	0.177	0.177	0.00
2/22/2018	3:00	1.4	17:35	2.0	1.6	3:45	4.4	20:05	6.2	5.2	2:50	0.114	17:35	0.277	0.177	0.177	0.07
2/23/2018	3:15	1.4	22:45	2.0	1.6	3:25	4.2	9:10	6.0	5.2	3:25	0.109	22:50	0.267	0.170	0.170	0.01
2/24/2018	5:00	1.4	10:10	2.1	1.7	4:45	4.2	10:15	6.2	5.2	4:45	0.111	10:10	0.293	0.177	0.177	0.13
2/25/2018	4:40	1.4	9:50	2.1	1.7	3:15	4.3	14:10	6.2	5.4	3:15	0.115	9:50	0.294	0.193	0.193	0.11
2/26/2018	4:05	1.4	21:10	2.0	1.6	4:10	4.3	19:40	6.1	5.2	4:10	0.111	21:10	0.264	0.174	0.174	0.00
2/27/2018	2:40	1.3	20:35	2.0	1.6	2:15	4.2	7:45	6.1	5.2	2:40	0.101	20:35	0.264	0.168	0.168	0.19
2/28/2018	3:40	1.4	19:05	2.1	1.7	4:15	4.1	19:05	6.3	5.3	3:35	0.106	19:05	0.297	0.181	0.181	0.35
ReportAvg	1.7					5.5					0.198						
ReportTotal																5.546	2.84

ADS Environmental Services

Pipe Height: 8.00

Date	REN_MH2999\mp1\DFINAL (inches)					REN_MH2999\mp1\VFINAL (feet/sec)					REN_MH2999\mp1\QFINAL (MGD - Total MG)					REN_RG\mp1\RAIN (inches)	
	Time	Min.	Time	Max.	Average	Time	Min.	Time	Max.	Average	Time	Min.	Time	Max.	Average	Total	Total
3/1/2018	3:50	1.4	21:20	2.0	1.7	3:05	4.5	21:20	6.2	5.3	2:55	0.124	21:20	0.278	0.186	0.186	0.01
3/2/2018	2:00	1.4	7:40	2.0	1.7	1:30	4.5	8:55	6.2	5.4	1:30	0.122	7:40	0.273	0.194	0.194	0.07
3/3/2018	3:30	1.4	9:15	2.1	1.7	3:20	4.5	9:20	6.2	5.4	3:20	0.122	9:20	0.298	0.190	0.190	0.00
3/4/2018	4:20	1.4	9:50	2.1	1.7	2:35	4.3	13:20	6.2	5.4	2:35	0.116	9:50	0.294	0.196	0.196	0.12
3/5/2018	3:50	1.4	9:40	2.1	1.7	2:30	4.4	19:55	6.1	5.3	3:50	0.116	9:40	0.281	0.188	0.188	0.00
3/6/2018	3:10	1.4	18:15	2.1	1.6	1:40	4.3	19:55	6.1	5.2	2:45	0.112	18:15	0.285	0.174	0.174	0.00
3/7/2018	2:40	1.4	9:00	2.1	1.6	2:30	4.2	7:40	6.1	5.2	2:30	0.109	9:00	0.279	0.174	0.174	0.03
3/8/2018	2:30	1.4	21:05	2.1	1.7	2:30	4.1	21:10	6.1	5.2	2:30	0.104	21:05	0.290	0.179	0.179	0.37
3/9/2018	3:25	1.4	9:20	2.1	1.7	3:15	4.4	18:50	6.1	5.2	3:15	0.117	18:50	0.286	0.179	0.179	0.00
3/10/2018	3:00	1.4	11:35	2.2	1.7	2:45	4.1	8:40	6.1	5.2	2:45	0.107	11:40	0.292	0.182	0.182	0.00
3/11/2018	2:20	1.4	10:10	2.2	1.7	2:10	4.0	19:05	6.0	5.1	2:10	0.103	21:35	0.293	0.179	0.179	0.00
3/12/2018	2:40	1.4	20:00	2.1	1.6	1:55	3.9	20:00	6.0	5.1	1:55	0.099	20:00	0.278	0.167	0.167	0.00
3/13/2018	2:10	1.4	18:50	2.2	1.6	1:20	4.0	18:00	6.2	5.1	1:20	0.105	18:50	0.304	0.174	0.174	0.31
3/14/2018	23:55	1.4	9:25	2.0	1.7	2:05	4.3	5:35	6.1	5.2	2:05	0.117	5:35	0.278	0.177	0.177	0.04
3/15/2018	2:55	1.4	7:50	2.1	1.6	2:30	4.1	19:35	6.1	5.2	2:30	0.107	7:50	0.279	0.173	0.173	0.00
3/16/2018	2:25	1.4	19:35	2.0	1.6	1:10	4.0	19:30	6.0	5.0	1:10	0.102	19:35	0.271	0.163	0.163	0.00
3/17/2018	3:20	1.3	11:20	2.1	1.6	2:25	3.8	8:25	6.1	5.0	2:25	0.096	11:20	0.282	0.165	0.165	0.00
3/18/2018	3:10	1.3	18:05	2.1	1.6	4:25	3.7	9:40	6.1	5.0	3:10	0.094	18:05	0.286	0.168	0.168	0.00
3/19/2018	2:00	1.3	18:35	2.0	1.6	1:45	3.7	18:35	6.1	4.9	2:00	0.093	18:35	0.278	0.156	0.156	0.00
3/20/2018	2:55	1.3	9:05	2.2	1.6	1:45	3.6	9:05	6.2	5.0	2:15	0.091	9:05	0.306	0.155	0.155	0.00
3/21/2018	2:00	1.3	7:15	2.0	1.5	0:45	3.5	7:15	6.0	4.9	0:45	0.087	7:15	0.259	0.152	0.152	0.10
3/22/2018	2:45	1.3	19:45	2.0	1.6	2:15	3.9	21:00	6.3	5.3	2:15	0.097	19:45	0.270	0.179	0.179	0.48
3/23/2018	2:00	1.4	10:30	2.1	1.7	2:25	4.3	11:20	6.3	5.4	2:25	0.114	10:30	0.296	0.192	0.192	0.31
3/24/2018	2:45	1.4	10:10	2.2	1.8	2:15	4.6	14:10	6.3	5.6	2:15	0.127	10:10	0.317	0.210	0.210	0.28
3/25/2018	2:55	1.4	9:05	2.1	1.7	2:55	4.7	8:15	6.4	5.5	2:55	0.126	9:05	0.311	0.196	0.196	0.01
3/26/2018	2:35	1.4	7:50	2.1	1.7	1:35	4.3	18:50	6.4	5.5	1:35	0.111	7:50	0.304	0.190	0.190	0.17
3/27/2018	2:20	1.4	8:20	2.2	1.7	0:30	4.6	8:20	6.4	5.4	2:05	0.125	8:20	0.314	0.185	0.185	0.02
3/28/2018	2:40	1.4	7:15	1.9	1.6	0:15	4.3	18:10	6.3	5.4	2:40	0.116	7:15	0.250	0.176	0.176	0.01
3/29/2018	2:50	1.4	18:50	2.0	1.6	2:40	4.5	17:35	6.2	5.3	2:40	0.116	18:50	0.275	0.174	0.174	0.00
3/30/2018	2:20	1.3	8:45	2.3	1.6	1:10	4.4	8:45	6.4	5.2	1:55	0.112	8:45	0.347	0.172	0.172	0.00
3/31/2018	3:05	1.4	15:05	2.0	1.6	2:05	4.2	9:45	6.2	5.2	2:05	0.108	15:05	0.276	0.175	0.175	0.00
ReportAvg	1.6					5.2					0.178						
ReportTotal																5.518	2.33

ADS Environmental Services

Pipe Height: 8.00

Date	REN_MH2999\mp1\DFINAL (inches)					REN_MH2999\mp1\VFINAL (feet/sec)					REN_MH2999\mp1\QFINAL (MGD - Total MG)					REN_RG\mp1\RAIN (inches)	
	Time	Min.	Time	Max.	Average	Time	Min.	Time	Max.	Average	Time	Min.	Time	Max.	Average	Total	Total
4/1/2018	5:40	1.3	12:35	2.0	1.7	3:25	4.1	12:35	6.2	5.2	3:25	0.104	12:35	0.284	0.179	0.179	0.10
4/2/2018	2:30	1.3	18:30	2.0	1.6	2:30	3.9	20:15	6.2	5.1	2:30	0.096	20:15	0.264	0.167	0.167	0.00
4/3/2018	23:55	1.4	21:05	1.9	1.6	0:35	3.6	19:35	6.1	5.0	0:35	0.102	7:35	0.252	0.164	0.164	0.00
4/4/2018	2:10	1.3	20:10	2.0	1.6	2:00	3.7	18:50	6.2	5.1	2:00	0.091	20:10	0.269	0.168	0.168	0.39
4/5/2018	3:05	1.4	18:45	2.0	1.7	2:00	4.1	19:40	6.3	5.2	2:00	0.107	19:40	0.282	0.178	0.178	0.25
4/6/2018	2:40	1.4	8:40	2.0	1.7	2:35	4.4	8:40	6.2	5.3	2:40	0.122	8:40	0.279	0.182	0.182	0.00
4/7/2018	2:10	1.4	9:05	2.5	1.9	2:00	4.3	9:05	6.6	5.8	2:00	0.114	9:05	0.387	0.240	0.240	0.88
4/8/2018	2:35	1.7	10:50	2.5	2.0	3:00	5.0	7:55	6.8	6.0	3:05	0.172	10:50	0.408	0.260	0.260	0.45
4/9/2018	2:35	1.6	19:40	2.2	1.8	2:35	5.1	18:45	6.7	5.8	2:35	0.169	19:40	0.337	0.230	0.230	0.00
4/10/2018	3:00	1.6	8:30	2.3	1.8	1:20	5.0	8:30	6.7	5.8	3:00	0.160	8:30	0.354	0.223	0.223	0.23
4/11/2018	3:20	1.6	19:20	2.2	1.8	2:50	5.0	19:15	6.7	5.7	3:20	0.155	19:20	0.336	0.216	0.216	0.31
4/12/2018	3:25	1.6	7:40	2.1	1.8	2:00	5.1	7:40	6.5	5.7	2:00	0.163	7:40	0.312	0.218	0.218	0.11
4/13/2018	1:30	1.5	22:45	2.3	1.8	1:45	4.9	22:45	6.5	5.7	1:45	0.148	22:45	0.351	0.224	0.224	0.51
4/14/2018	3:30	1.7	20:40	2.9	2.3	3:25	5.3	21:55	6.9	6.3	3:25	0.195	19:25	0.500	0.340	0.340	1.52
4/15/2018	23:55	1.9	1:00	2.9	2.3	23:40	5.8	9:20	6.9	6.5	23:55	0.249	1:00	0.505	0.349	0.349	0.21
4/16/2018	3:20	1.9	16:35	2.6	2.1	1:45	5.7	16:35	7.0	6.3	3:05	0.230	16:35	0.443	0.300	0.300	0.71
4/17/2018	23:40	1.8	20:45	2.3	2.0	23:20	5.7	6:15	6.8	6.2	23:25	0.220	7:05	0.366	0.276	0.276	0.01
4/18/2018	23:50	1.7	7:30	2.2	1.9	2:25	5.4	20:25	6.6	5.9	23:50	0.195	7:30	0.341	0.244	0.244	0.12
4/19/2018	2:35	1.6	7:35	2.2	1.8	2:00	5.0	7:35	6.6	5.8	2:35	0.166	7:35	0.322	0.223	0.223	0.00
4/20/2018	1:35	1.6	8:35	2.1	1.8	3:40	4.9	7:30	6.3	5.6	3:40	0.155	8:35	0.298	0.213	0.213	0.00
4/21/2018	3:55	1.5	9:15	2.2	1.8	3:55	4.9	9:10	6.4	5.5	3:55	0.149	9:15	0.317	0.212	0.212	0.05
4/22/2018	4:30	1.5	8:55	2.2	1.8	23:50	4.7	17:50	6.3	5.5	4:30	0.138	8:55	0.316	0.210	0.210	0.00
ReportAvg	1.8					5.7					0.228						
ReportTotal																5.019	5.85

REN_MH3216

Located At: West of 4022 Talbot Rd S (see attached site report for details)
Monitoring Period: December 22, 2017 – April 22, 2018
Pipe Dimensions: 7.38"
Finalized Silt Level: 0 mm

Site Data Characteristics: This site is located in a sanitary sewer pipe. The scattergraph indicates site operated in free flow conditions. The site did not surcharge during the monitoring period. The dry weather data plots below the Froude =1 curve indicating subcritical flow.

Site Data Bias & Editing: The depth and velocity measurements recorded by the flow monitor were consistent with field confirmations conducted to date and supported the relative accuracy of the flow monitor at this location. The finalized depth data utilized the upward ultrasonic sensor and the pressure sensor.

Site Data Uptime: The data uptime achieved during the monitoring period is provided in the table below. Based upon the quality and consistency of the observed flow depth and velocity data, the Continuity equation was used to calculate the flow rate for the monitoring period.

Entity	Percentage Uptime Raw	Percentage Uptime Final
Depth (in)	100%	94%
Velocity (f/s)	100%	94%
Quantity (mgd)	100%	94%

Site Data Summary: The average flow depth, velocity, and quantity data observed during the monitoring period along with observed minimum and maximum data, are provided in the following table. The minimum and maximum rates recorded in the tables are based on 5-minute data intervals.

Item	Depth (in)	Velocity (f/s)	Quantity (mgd)	% Full
Minimum	1.41	0.33	0.011	19%
Maximum	6.76	2.41	0.445	92%
Average	2.55	0.96	0.059	35%

Renton.Carollo.I&I.WA17

Flow Monitoring Site Report



Site Name

REN_MH5519

Site Address /Location:	West of 4033 Talbot Rd S, Renton, WA 98055, USA		Monitor Series	Location Type
Site Access Details:	Off of Talbot Rd, down brush area from parking lot west of Valley Medical Center	Latitude:	47.444195°	Temporary
		Longitude:	-122.216122°	Pipe Shape
			10.25" x 10.25"	Circular

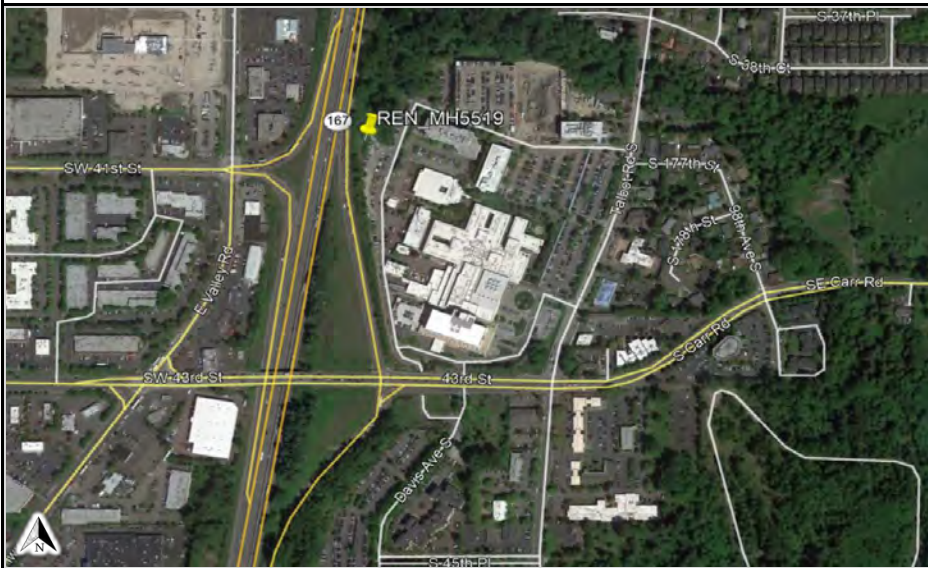

Manhole #	System Characteristics
MH5519	Other
Access	Traffic
Drive	Light



Installation Information

Installation Date:	12.14.17	Installation Type:	Doppler Special Installation
Monitoring Location (Sensors):	Upstream 0-5 FT	Monitor Location:	Manhole
Sensors / Devices:	Peak Combo (CS4)	Pressure Sensor Range (psi)	0 - 5 psi

Installation Confirmation:

Confirmation Time:	-	Pipe Size (HxW)	10.25" x 10.25"
Depth of Flow (Wet DOF) (in)	~2.25"	Range (Air DOF) (in)	
Downlooker Physical Offset (in)	1.38"	Measurement Confidence (in)	0.25"
Peak Velocity (fps)	~6.00 FPS	Velocity Sensor Offset (in)	
Silt (in)	0	Silt Type	

Hydraulic Comments:
Low, fast flow

Manhole / Pipe Information:

Manhole Depth (Approx. FT):	~8'	Manhole Configuration	Single
Manhole Material:	Concrete	Manhole Condition:	Good
Manhole Opening Diameter (in)	20"	Manhole Diameter (Approx.):	20"
Manhole Cover	Vented	Manhole Frame	Normal
Active Drop Connections	No	Air Quality:	Normal
Pipe Material	PVC	Pipe Condition:	Good

Communication Information:

Communication Type	Wireless	Antenna Location	Manhole Pick / Vent Hole
--------------------	----------	------------------	--------------------------

Additional Site Info. / Comments:

Off trail. Confirmation information available from ADS.

ADS Project Name:	Renton.Carollo.I&I.WA17
ADS Project Number:	22275.11.325

Additional Photos

Upstream



Downstream



Side Inlet



Second Side Inlet (usually dry)



Top Down



Secondary Top Down - Outlet Oriented



Location



- Flow Direction
- ⊗ Monitoring Point



HYDROGRAPH REPORT

REN_MH3216

Flow Monitor
REN_MH3216

Pipe Height
7.38 in

Report Period
12/22/2017
To
4/22/2018

Legend
— Depth
— Velocity

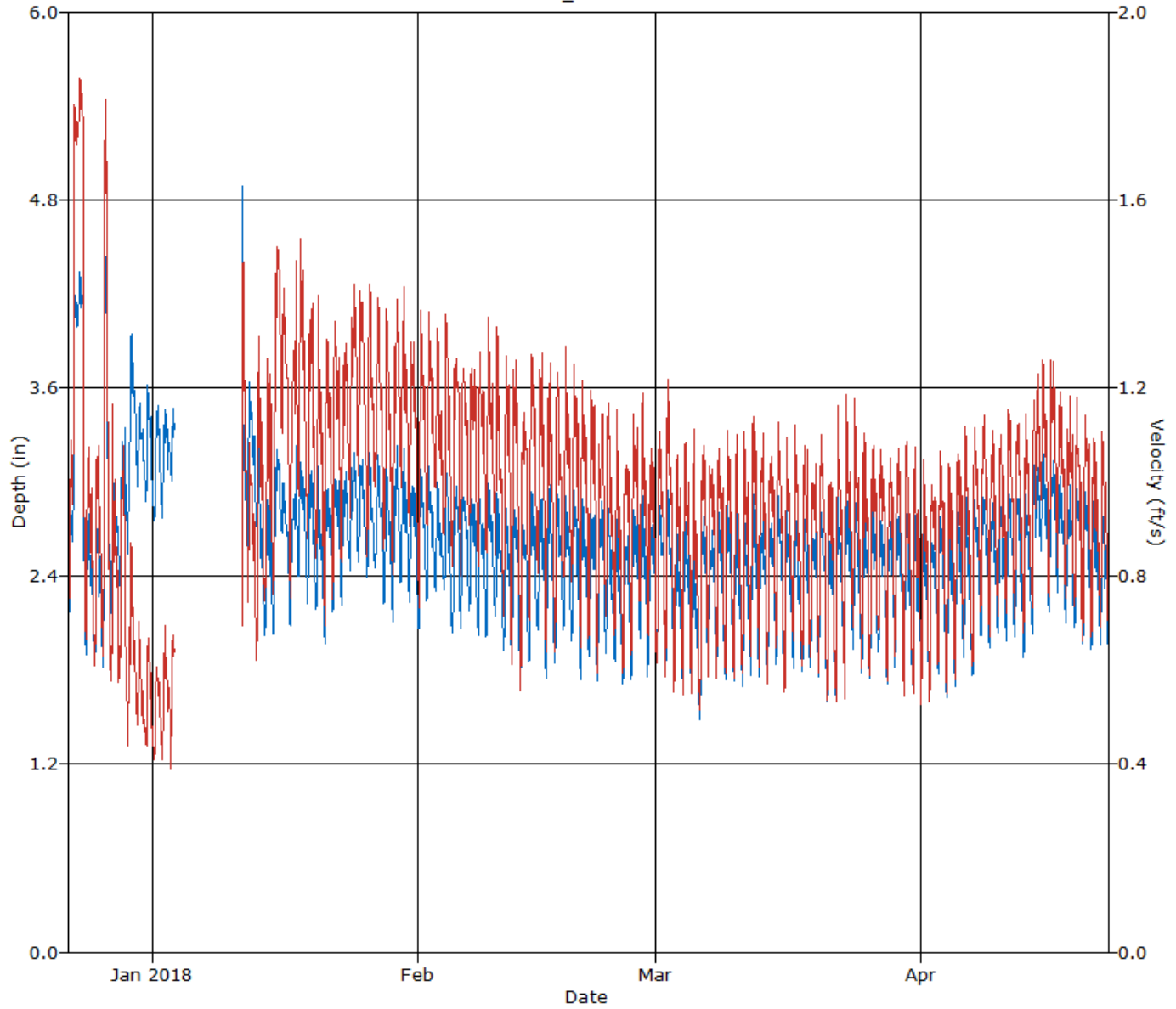

HYDROGRAPH REPORT

REN_MH3216

Flow Monitor
REN_MH3216

Pipe Height
7.38 in.

Report Period
12/22/2017
To
4/22/2018

Legend
— Quantity

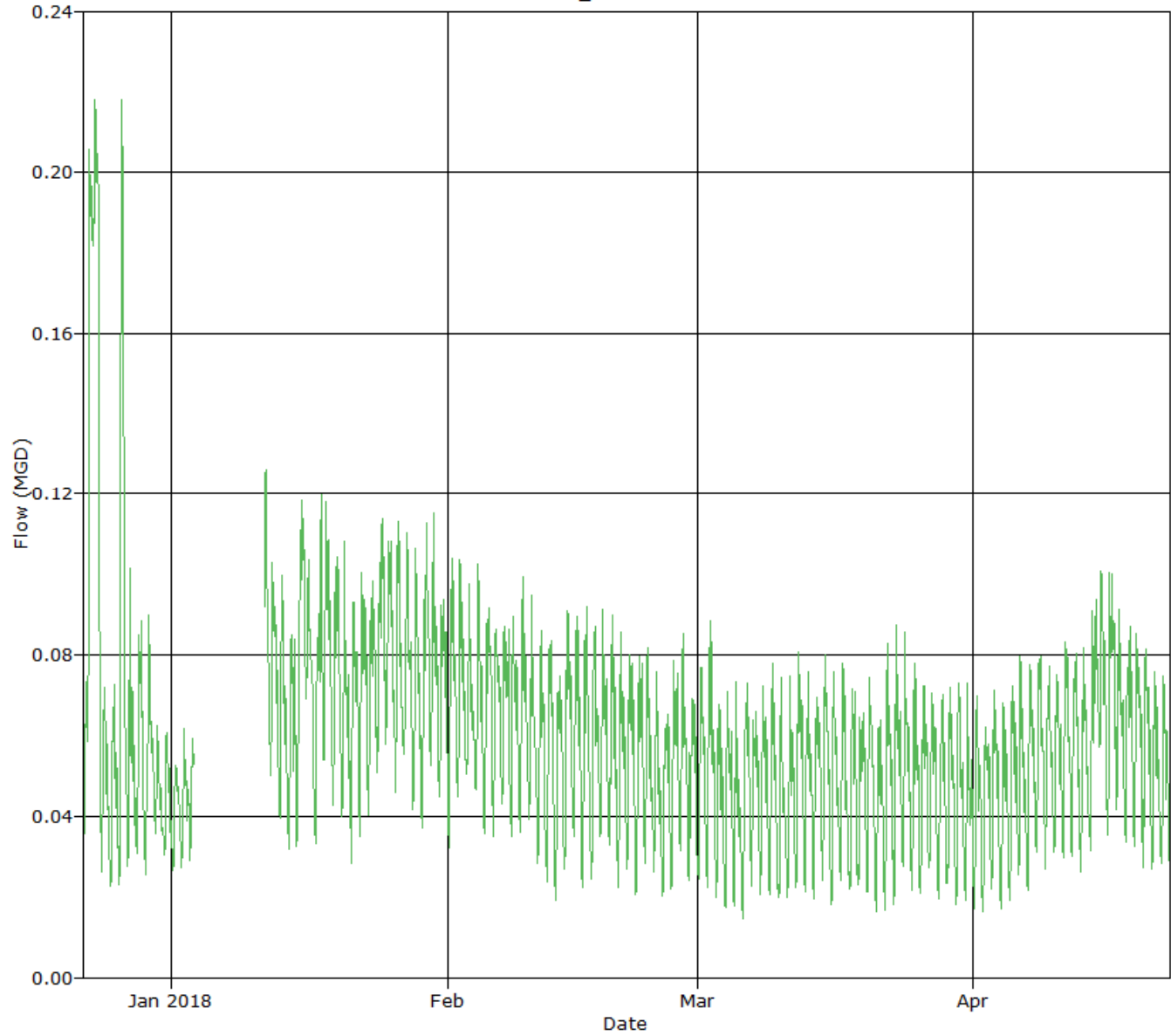

SCATTERGRAPH REPORT

REN_MH3216

Flow Monitor
REN_MH3216

Pipe Height
7.38 in

Report Period
12/22/2017
To
4/22/2018

Legend
○ Depth - Velocity
--- Iso-Q™
--- Silt
▼ Min-Max Depth

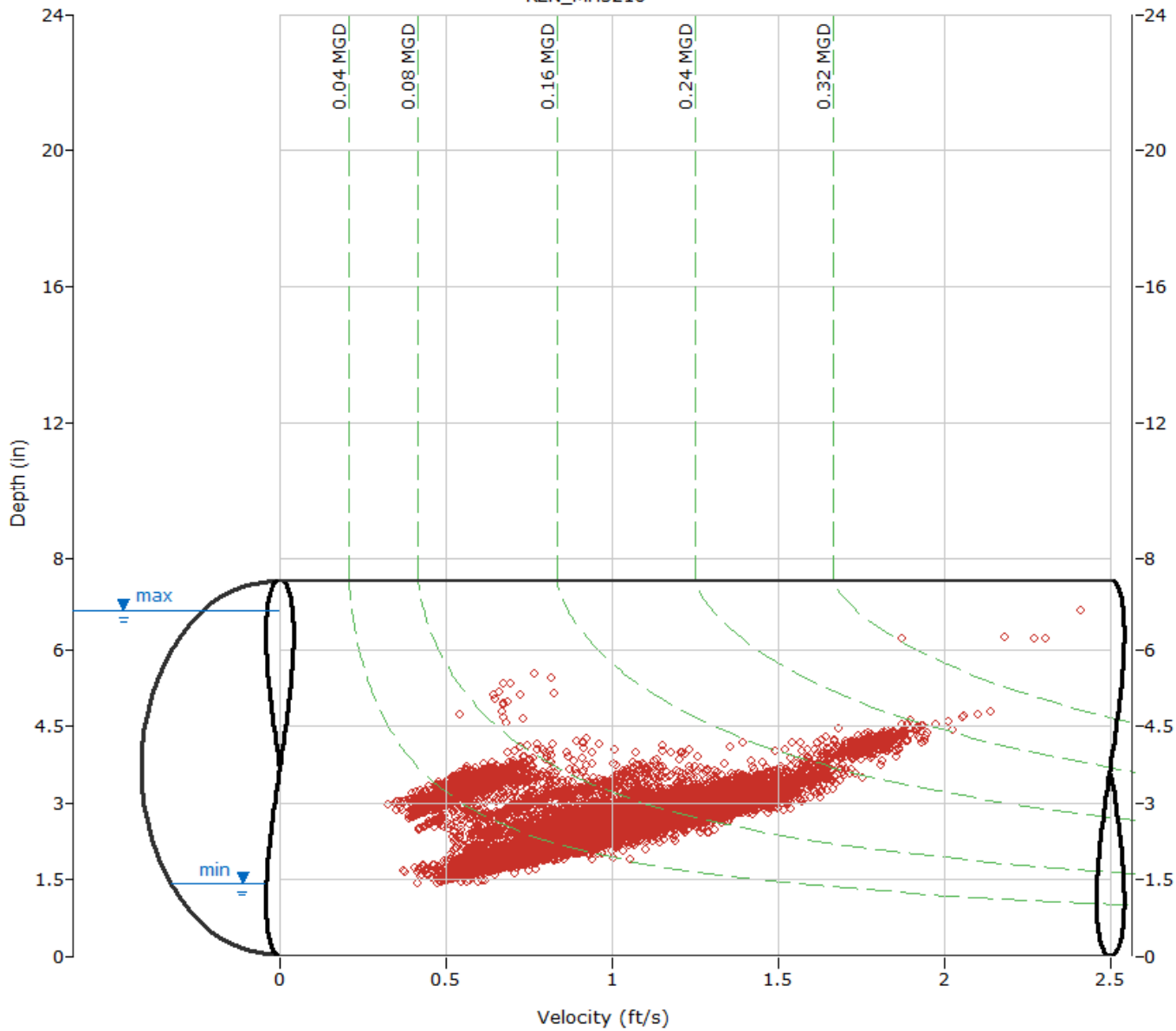

ADS Environmental Services

Pipe Height: 7.38

Date	REN_MH3216\mp1\DFINAL (inches)					REN_MH3216\mp1\VFINAL (feet/sec)					REN_MH3216\mp1\QFINAL (MGD - Total MG)					
	Time	Min.	Time	Max.	Average	Time	Min.	Time	Max.	Average	Time	Min.	Time	Max.	Average	Total
12/22/2017	3:45	2.1	19:30	4.4	3.0	4:15	0.7	18:20	1.9	1.2	3:45	0.031	19:30	0.218	0.098	0.098
12/23/2017	23:55	2.3	4:50	4.7	4.0	23:15	0.8	4:50	2.1	1.7	23:55	0.040	4:50	0.265	0.182	0.182
12/24/2017	4:10	1.9	13:40	3.2	2.4	3:30	0.6	13:40	1.3	0.9	4:10	0.024	13:40	0.100	0.049	0.049
12/25/2017	4:15	1.8	12:20	3.3	2.3	4:20	0.5	12:20	1.4	0.8	4:20	0.019	12:20	0.120	0.045	0.045
12/26/2017	3:25	1.8	9:40	6.8	3.0	3:50	0.5	9:40	2.4	1.1	3:50	0.016	9:40	0.445	0.095	0.095
12/27/2017	2:00	2.0	16:00	3.7	2.7	4:25	0.3	7:15	1.3	0.8	2:00	0.021	7:15	0.121	0.052	0.052
12/28/2017	3:10	2.2	17:50	3.9	2.8	23:25	0.5	13:25	1.5	0.8	3:10	0.026	13:25	0.144	0.056	0.056
12/29/2017	1:25	2.5	11:05	4.3	3.4	1:20	0.4	12:50	1.2	0.6	1:20	0.024	10:50	0.113	0.057	0.057
12/30/2017	5:05	2.9	13:10	3.8	3.3	20:25	0.4	10:05	0.8	0.6	23:00	0.029	10:00	0.069	0.046	0.046
12/31/2017	3:15	2.8	16:45	3.7	3.2	6:05	0.4	8:45	0.7	0.5	6:05	0.024	8:45	0.069	0.044	0.044
ReportAvg	3.0					0.9					0.072					
ReportTotal											0.723					

ADS Environmental Services

Pipe Height: 7.38

Date	REN_MH3216\mp1\DFINAL (inches)					REN_MH3216\mp1\VFINAL (feet/sec)					REN_MH3216\mp1\QFINAL (MGD - Total MG)					
	Time	Min.	Time	Max.	Average	Time	Min.	Time	Max.	Average	Time	Min.	Time	Max.	Average	Total
2/1/2018	4:30	1.9	15:10	3.6	2.6	4:00	0.6	15:10	1.6	1.1	4:00	0.029	15:10	0.153	0.069	0.069
2/2/2018	3:00	2.2	10:05	3.9	2.7	3:45	0.8	10:35	1.7	1.2	3:45	0.040	10:35	0.164	0.075	0.075
2/3/2018	3:15	2.2	19:55	3.4	2.6	4:45	0.8	10:55	1.5	1.1	4:45	0.044	19:55	0.124	0.068	0.068
2/4/2018	23:55	2.1	10:10	4.0	2.6	2:40	0.8	10:10	1.9	1.1	23:55	0.040	10:10	0.201	0.068	0.068
2/5/2018	4:20	2.0	15:05	3.7	2.6	2:25	0.7	15:05	1.8	1.1	2:25	0.028	15:05	0.177	0.069	0.069
2/6/2018	3:40	2.0	12:10	3.4	2.6	1:35	0.7	12:10	1.6	1.1	1:35	0.033	12:10	0.137	0.066	0.066
2/7/2018	23:40	2.1	19:50	3.7	2.6	0:45	0.8	16:00	1.6	1.1	0:45	0.039	19:50	0.152	0.066	0.066
2/8/2018	3:50	1.9	11:50	3.7	2.5	2:55	0.8	11:50	1.6	1.1	2:55	0.031	11:50	0.158	0.064	0.064
2/9/2018	4:10	1.9	13:55	3.7	2.5	1:40	0.7	13:55	1.6	1.1	1:40	0.029	13:55	0.159	0.066	0.066
2/10/2018	3:25	2.1	13:45	3.5	2.5	20:45	0.8	13:45	1.6	1.1	3:25	0.035	13:45	0.146	0.061	0.061
2/11/2018	3:45	1.9	12:20	3.5	2.4	1:25	0.6	12:20	1.7	1.0	1:30	0.026	12:20	0.147	0.056	0.056
2/12/2018	0:40	1.8	11:10	3.7	2.4	0:30	0.5	14:25	1.6	1.0	0:30	0.019	11:10	0.148	0.057	0.057
2/13/2018	3:10	1.7	17:25	3.5	2.3	3:05	0.4	17:25	1.6	0.9	3:05	0.012	17:25	0.142	0.051	0.051
2/14/2018	1:25	1.8	14:10	3.6	2.5	1:55	0.5	14:10	1.7	1.0	1:55	0.020	14:10	0.155	0.061	0.061
2/15/2018	22:55	2.0	8:50	3.4	2.5	23:55	0.7	8:50	1.6	1.0	23:55	0.027	8:50	0.137	0.061	0.061
2/16/2018	1:40	1.6	17:15	3.7	2.4	2:50	0.6	17:15	1.6	1.0	2:50	0.020	17:15	0.160	0.057	0.057
2/17/2018	3:15	1.7	23:00	3.3	2.4	4:00	0.5	23:00	1.4	1.0	4:00	0.020	23:00	0.116	0.057	0.057
2/18/2018	3:55	2.0	9:00	3.5	2.5	5:20	0.7	9:00	1.6	1.0	3:20	0.031	9:00	0.140	0.059	0.059
2/19/2018	3:40	1.9	11:40	3.3	2.5	3:15	0.8	9:55	1.5	1.0	3:40	0.030	11:40	0.121	0.059	0.059
2/20/2018	2:45	1.7	7:15	3.8	2.4	4:15	0.5	7:15	1.8	1.0	4:15	0.018	7:15	0.181	0.055	0.055
2/21/2018	1:40	1.8	19:25	3.4	2.4	2:10	0.6	19:25	1.6	1.0	2:10	0.021	19:25	0.133	0.056	0.056
2/22/2018	4:55	1.7	13:40	3.6	2.4	3:25	0.5	15:00	1.5	0.9	3:25	0.017	15:00	0.135	0.052	0.052
2/23/2018	3:55	1.8	10:15	4.0	2.4	2:55	0.6	10:15	1.7	1.0	3:45	0.024	10:15	0.184	0.054	0.054
2/24/2018	4:20	1.8	14:30	3.2	2.3	3:45	0.6	14:30	1.4	0.9	3:45	0.022	14:30	0.109	0.047	0.047
2/25/2018	3:15	1.6	18:25	3.6	2.3	1:30	0.5	18:25	1.5	0.9	1:30	0.017	18:25	0.137	0.046	0.046
2/26/2018	3:05	1.7	15:20	3.6	2.4	0:30	0.5	15:20	1.5	0.9	2:25	0.018	15:20	0.143	0.053	0.053
2/27/2018	23:50	1.9	10:20	3.6	2.4	0:45	0.6	10:20	1.6	0.9	0:45	0.028	10:20	0.150	0.053	0.053
2/28/2018	1:15	1.6	10:55	3.5	2.4	2:25	0.6	10:55	1.4	0.9	0:40	0.020	10:55	0.129	0.051	0.051
ReportAvg	2.5					1.0					0.059					
ReportTotal											1.657					

ADS Environmental Services

Pipe Height: 7.38

Date	REN_MH3216\mp1\DFINAL (inches)					REN_MH3216\mp1\VFINAL (feet/sec)					REN_MH3216\mp1\QFINAL (MGD - Total MG)						
	Time	Min.	Time	Max.	Average	Time	Min.	Time	Max.	Average	Time	Min.	Time	Max.	Average	Total	
3/1/2018	2:40	1.8	10:25	3.7	2.4	4:05	0.5	10:00	1.5	0.9	2:40	0.020	10:25	0.140	0.051	0.051	
3/2/2018	4:00	1.7	10:45	3.6	2.4	3:50	0.5	10:45	1.6	1.0	3:50	0.020	10:45	0.149	0.056	0.056	
3/3/2018	2:55	1.7	11:10	3.1	2.2	4:35	0.4	11:10	1.3	0.8	4:35	0.015	11:10	0.100	0.043	0.043	
3/4/2018	4:55	1.6	13:30	3.3	2.3	4:45	0.5	15:10	1.4	0.9	4:45	0.015	15:10	0.115	0.045	0.045	
3/5/2018	23:55	1.6	10:40	3.2	2.1	2:30	0.4	10:25	1.3	0.8	2:30	0.014	10:40	0.099	0.038	0.038	
3/6/2018	4:35	1.4	12:05	3.6	2.3	4:35	0.4	12:05	1.5	0.9	4:35	0.011	12:05	0.142	0.047	0.047	
3/7/2018	3:25	1.7	13:10	3.4	2.3	3:25	0.4	13:10	1.3	0.9	3:25	0.013	13:10	0.116	0.048	0.048	
3/8/2018	3:05	1.8	13:30	3.5	2.4	3:00	0.5	10:05	1.4	0.9	3:00	0.018	13:30	0.127	0.048	0.048	
3/9/2018	4:10	1.7	10:55	3.5	2.3	2:00	0.5	10:55	1.4	0.9	4:10	0.018	10:55	0.126	0.048	0.048	
3/10/2018	3:15	1.7	8:45	3.3	2.2	3:25	0.5	8:45	1.3	0.8	3:25	0.017	8:45	0.112	0.043	0.043	
3/11/2018	2:45	1.6	9:25	3.2	2.3	2:35	0.5	9:25	1.4	0.8	2:35	0.015	9:25	0.112	0.044	0.044	
3/12/2018	3:05	1.7	14:15	3.6	2.4	1:15	0.6	14:15	1.5	0.9	3:05	0.020	14:15	0.136	0.052	0.052	
3/13/2018	2:25	1.7	11:15	3.5	2.3	2:25	0.5	11:15	1.5	0.9	2:25	0.018	11:15	0.135	0.048	0.048	
3/14/2018	2:05	1.6	14:05	3.4	2.4	3:30	0.5	12:05	1.5	0.9	2:05	0.017	16:05	0.124	0.049	0.049	
3/15/2018	23:55	1.7	10:20	3.8	2.4	2:40	0.6	10:20	1.6	0.9	23:55	0.021	10:20	0.162	0.051	0.051	
3/16/2018	3:50	1.6	9:35	3.7	2.3	3:50	0.5	7:15	1.4	0.9	3:50	0.015	9:35	0.138	0.046	0.046	
3/17/2018	2:25	1.8	7:40	3.4	2.3	2:25	0.6	8:20	1.4	0.9	2:25	0.023	7:40	0.119	0.047	0.047	
3/18/2018	3:45	1.7	11:25	3.4	2.3	4:10	0.5	11:25	1.4	0.9	4:10	0.019	11:25	0.120	0.047	0.047	
3/19/2018	3:00	1.8	13:45	3.7	2.4	3:20	0.6	13:45	1.6	0.9	3:00	0.021	13:45	0.154	0.048	0.048	
3/20/2018	23:10	1.7	9:10	3.5	2.3	23:55	0.5	11:00	1.4	0.9	23:55	0.018	9:10	0.121	0.047	0.047	
3/21/2018	1:50	1.5	13:55	3.5	2.2	3:15	0.5	15:30	1.5	0.8	2:35	0.015	13:55	0.133	0.042	0.042	
3/22/2018	2:35	1.5	7:50	3.6	2.3	3:10	0.4	7:50	1.6	0.9	3:10	0.012	7:50	0.147	0.048	0.048	
3/23/2018	1:30	1.6	8:35	3.8	2.4	1:20	0.5	8:35	1.6	0.9	1:20	0.016	8:35	0.159	0.053	0.053	
3/24/2018	2:25	1.9	8:20	3.3	2.4	2:25	0.7	8:20	1.4	0.9	2:25	0.025	8:20	0.121	0.052	0.052	
3/25/2018	23:30	1.7	13:25	3.3	2.3	3:55	0.5	13:25	1.5	0.9	23:30	0.018	13:25	0.124	0.048	0.048	
3/26/2018	3:05	1.6	15:35	3.4	2.4	3:20	0.5	15:35	1.4	0.9	3:05	0.016	15:35	0.120	0.049	0.049	
3/27/2018	23:40	1.7	13:40	3.4	2.4	23:40	0.6	8:25	1.4	0.9	23:40	0.020	8:25	0.122	0.049	0.049	
3/28/2018	2:10	1.6	9:55	3.5	2.3	2:25	0.5	8:55	1.4	0.9	2:25	0.016	9:55	0.116	0.046	0.046	
3/29/2018	0:45	1.7	9:20	3.6	2.4	0:45	0.6	9:20	1.5	0.9	0:45	0.019	9:20	0.137	0.047	0.047	
3/30/2018	3:25	1.6	11:50	3.2	2.3	0:05	0.4	12:10	1.3	0.9	0:05	0.015	11:50	0.102	0.046	0.046	
3/31/2018	3:25	1.6	8:45	3.5	2.2	4:35	0.5	8:45	1.4	0.8	4:35	0.016	8:45	0.129	0.043	0.043	
ReportAvg					2.3					0.9							0.047
ReportTotal																	1.470

ADS Environmental Services

Pipe Height: 7.38

Date	REN_MH3216\mp1\DFINAL (inches)					REN_MH3216\mp1\VFINAL (feet/sec)					REN_MH3216\mp1\QFINAL (MGD - Total MG)					
	Time	Min.	Time	Max.	Average	Time	Min.	Time	Max.	Average	Time	Min.	Time	Max.	Average	Total
4/1/2018	2:20	1.6	8:55	3.2	2.2	3:30	0.4	8:55	1.2	0.8	3:30	0.012	8:55	0.098	0.042	0.042
4/2/2018	2:05	1.6	10:45	3.4	2.3	2:05	0.4	10:45	1.5	0.8	2:05	0.013	10:45	0.128	0.044	0.044
4/3/2018	23:45	1.7	12:15	3.4	2.3	1:30	0.5	12:15	1.4	0.9	23:45	0.018	12:15	0.127	0.047	0.047
4/4/2018	2:00	1.5	12:50	3.4	2.3	2:00	0.5	12:50	1.4	0.8	2:00	0.014	12:50	0.120	0.044	0.044
4/5/2018	2:05	1.6	9:45	3.4	2.4	2:05	0.5	9:55	1.4	0.9	2:05	0.017	9:45	0.119	0.050	0.050
4/6/2018	2:10	1.8	11:20	3.6	2.4	1:20	0.6	11:20	1.5	0.9	23:45	0.023	11:20	0.143	0.049	0.049
4/7/2018	2:35	1.7	10:00	3.3	2.4	0:25	0.5	10:00	1.4	0.9	2:30	0.018	10:00	0.114	0.053	0.053
4/8/2018	1:45	1.9	12:15	3.4	2.5	1:50	0.7	12:15	1.4	0.9	1:45	0.028	12:15	0.120	0.056	0.056
4/9/2018	2:45	1.9	11:55	3.5	2.5	2:10	0.6	11:55	1.4	0.9	2:10	0.025	11:55	0.132	0.054	0.054
4/10/2018	3:05	1.9	11:45	3.6	2.5	2:50	0.7	11:45	1.5	0.9	3:05	0.026	11:45	0.141	0.054	0.054
4/11/2018	3:00	1.9	15:45	3.5	2.5	0:20	0.6	11:20	1.5	1.0	0:20	0.027	15:45	0.127	0.058	0.058
4/12/2018	2:25	1.9	9:05	3.5	2.5	1:00	0.6	12:00	1.5	0.9	1:00	0.026	12:00	0.135	0.056	0.056
4/13/2018	2:00	1.8	11:00	3.6	2.5	0:30	0.6	11:00	1.5	0.9	3:05	0.024	11:00	0.140	0.054	0.054
4/14/2018	3:35	2.0	19:00	3.6	2.7	3:35	0.7	7:50	1.5	1.0	3:35	0.028	7:50	0.134	0.067	0.067
4/15/2018	23:40	2.2	9:35	3.5	2.8	23:40	0.8	13:10	1.5	1.1	23:40	0.038	9:35	0.130	0.073	0.073
4/16/2018	3:20	2.1	7:40	4.0	2.8	2:25	0.7	7:40	1.8	1.1	2:25	0.032	7:40	0.195	0.072	0.072
4/17/2018	23:40	2.1	8:00	4.1	2.7	23:35	0.8	8:00	1.8	1.0	23:40	0.035	8:00	0.199	0.064	0.064
4/18/2018	23:40	2.0	12:50	3.6	2.6	3:10	0.7	13:10	1.4	1.0	3:10	0.031	13:10	0.131	0.060	0.060
4/19/2018	22:15	2.0	11:25	3.6	2.6	22:25	0.6	11:25	1.5	1.0	22:15	0.026	11:25	0.136	0.060	0.060
4/20/2018	2:00	1.9	14:40	3.7	2.5	2:00	0.6	14:40	1.6	0.9	2:00	0.023	14:40	0.150	0.057	0.057
4/21/2018	2:05	1.8	6:35	3.3	2.4	1:55	0.6	6:35	1.3	0.9	2:05	0.023	6:35	0.114	0.051	0.051
4/22/2018	23:55	1.9	9:55	3.3	2.4	23:55	0.6	9:55	1.3	0.9	23:55	0.024	9:55	0.111	0.050	0.050
ReportAvg	2.5					0.9					0.055					
ReportTotal											1.217					

REN_MH3625

Located At: 4201 NE Sunset Blvd (see attached site report for details)
Monitoring Period: December 22, 2017 – April 22, 2018
Pipe Dimensions: 12"
Finalized Silt Level: 0 mm

Site Data Characteristics: This site is located in a sanitary sewer pipe. The scattergraph indicates site operated in free flow conditions. The site did not surcharge during the monitoring period. The dry weather data plots below the Froude =1 curve indicating subcritical flow.

Site Data Bias & Editing: The depth and velocity measurements recorded by the flow monitor were consistent with field confirmations conducted to date and supported the relative accuracy of the flow monitor at this location. The finalized depth data utilized the upward ultrasonic sensor.

Site Data Uptime: The data uptime achieved during the monitoring period is provided in the table below. Based upon the quality and consistency of the observed flow depth and velocity data, the Continuity equation was used to calculate the flow rate for the monitoring period.

Entity	Percentage Uptime	
	Raw	Final
Depth (in)	100%	100%
Velocity (f/s)	100%	100%
Quantity (mgd)	100%	100%

Site Data Summary: The average flow depth, velocity, and quantity data observed during the monitoring period along with observed minimum and maximum data, are provided in the following table. The minimum and maximum rates recorded in the tables are based on 5-minute data intervals.

Item	Depth (in)	Velocity (f/s)	Quantity (mgd)	% Full
Minimum	3.28	1.71	0.198	27%
Maximum	11.73	3.67	1.855	98%
Average	5.86	2.78	0.702	49%

Renton. Carollo.I&I.WA17



Site Name

Flow Monitoring Site Report

REN_MH3625

Site Address /Location:	4201 NE Sunset Blvd		Monitor Series	Location Type
Site Access Details:	Site located between trees and bus top, park in lot	Latitude:	TRITON+	Temporary
		Longitude:	Pipe Size (H x W)	Pipe Shape
			12.00" x 12.00"	Circular

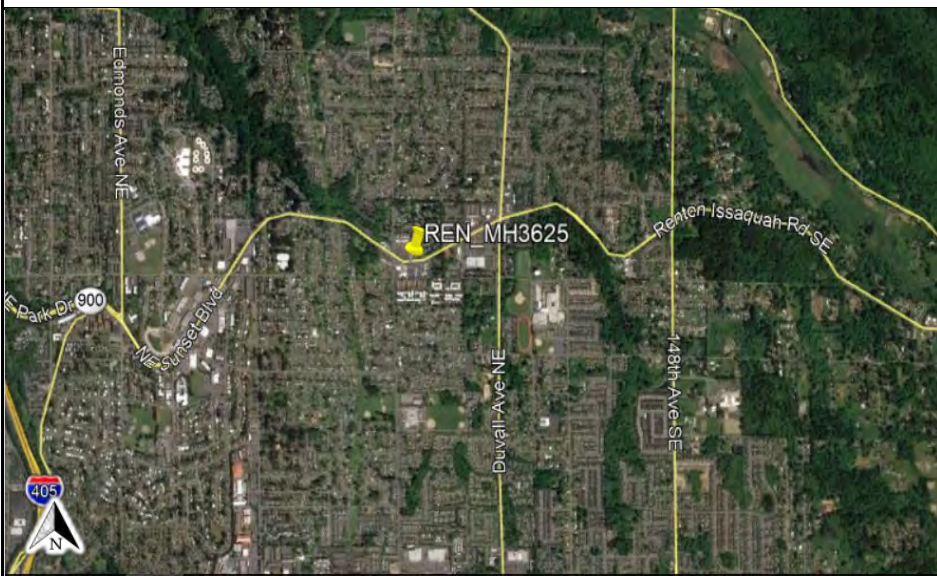

Manhole #	System Characteristics
MH5505	Residential / Commercial
Access	Traffic
Drive	None



Installation Information	
Installation Date:	Installation Type:
Wednesday, November 29, 2017	Doppler Standard Ring and Crank
Monitoring Location (Sensors):	Monitor Location:
Downstream 0-5 FT	Manhole
Sensors / Devices:	Pressure Sensor Range (psi)
Peak Combo (CS4), Smart Depth (CS5)	0 - 5 psi

Installation Confirmation:	
Confirmation Time:	Pipe Size (HxW)
11:50:00 AM	12.00" x 12.00"
Depth of Flow (Wet DOF) (in)	
4.38"	
CS5 Physical Offset (in)	Measurement Confidence (in)
1.38"	0.25"
Peak Velocity (fps)	Velocity Sensor Offset (in)
3.27'	0"
Silt (in)	Silt Type
0.00"	

Hydraulic Comments:
Smooth flow with some ripples

Manhole / Pipe Information:	
Manhole Depth (Approx. FT):	Manhole Configuration
11'	Sanitary Sewer Overflow
Manhole Material:	Manhole Condition:
Brick	Good
Manhole Opening Diameter (in)	Manhole Diameter (Approx.):
20"	20"
Manhole Cover	Manhole Frame
Steel	Normal
Active Connections	Air Quality:
Yes, Inside	Normal
Pipe Material	Pipe Condition:
Vitrified Clay Pipe	Fair

Communication Information:	
Communication Type	Antenna Location
Wireless	Manhole Pick / Vent Hole

Additional Site Info. / Comments:
None.

ADS Project Name:	Renton. Carollo.I&I.WA17
ADS Project Number:	22275.11.325

Additional Photos

Inlet



Outlet



Top Down

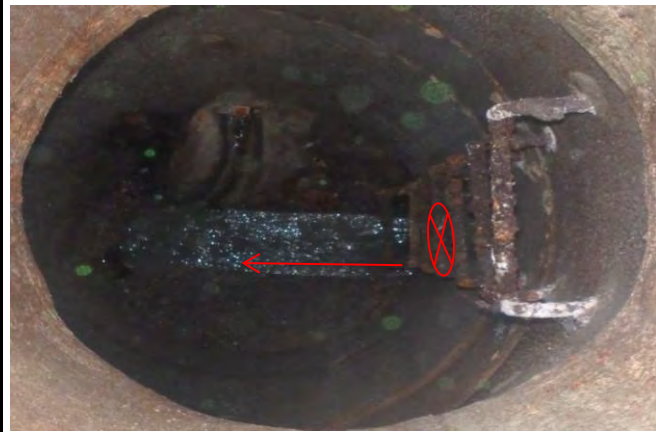

Location



Location Map



KEY

- Flow Direction
- ⊗ Monitoring Point

HYDROGRAPH REPORT

REN_MH3625

Flow Monitor
REN_MH3625

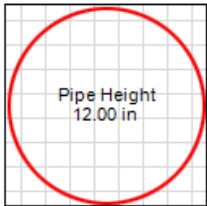

Report Period
12/22/2017
To
4/22/2018

Legend
— Depth
— Velocity
— Rain

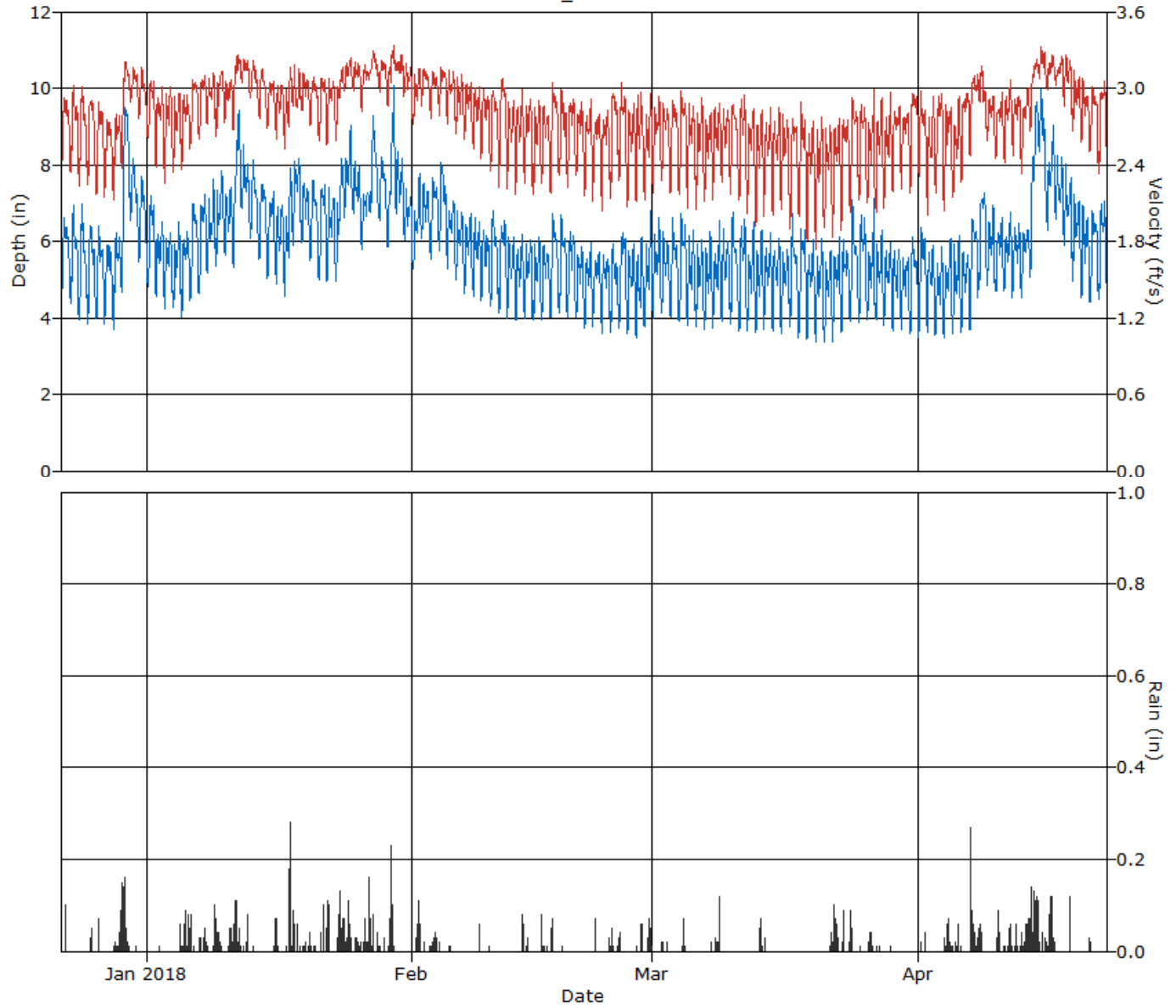

HYDROGRAPH REPORT

REN_MH3625

Flow Monitor
REN_MH3625

Pipe Height
12.00 in.

Report Period
12/22/2017
To
4/22/2018

Legend
— Quantity
— Rain

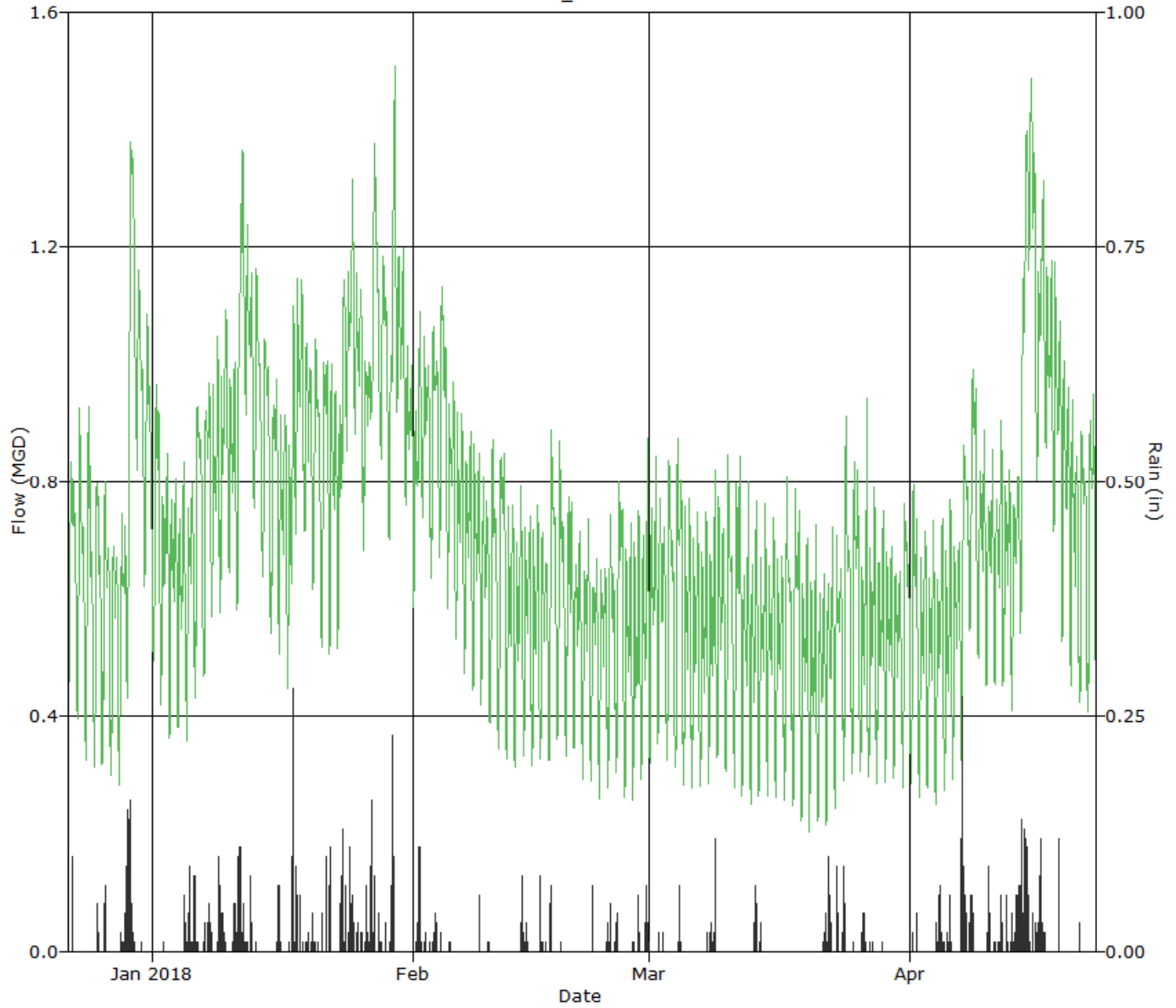

SCATTERGRAPH REPORT

REN_MH3625

Flow Monitor
REN_MH3625

Pipe Height
12.00 in

Report Period
12/22/2017
To
4/22/2018

Legend
○ Depth - Velocity
--- Iso-Q™
- - - Silt
▼ Min-Max Depth

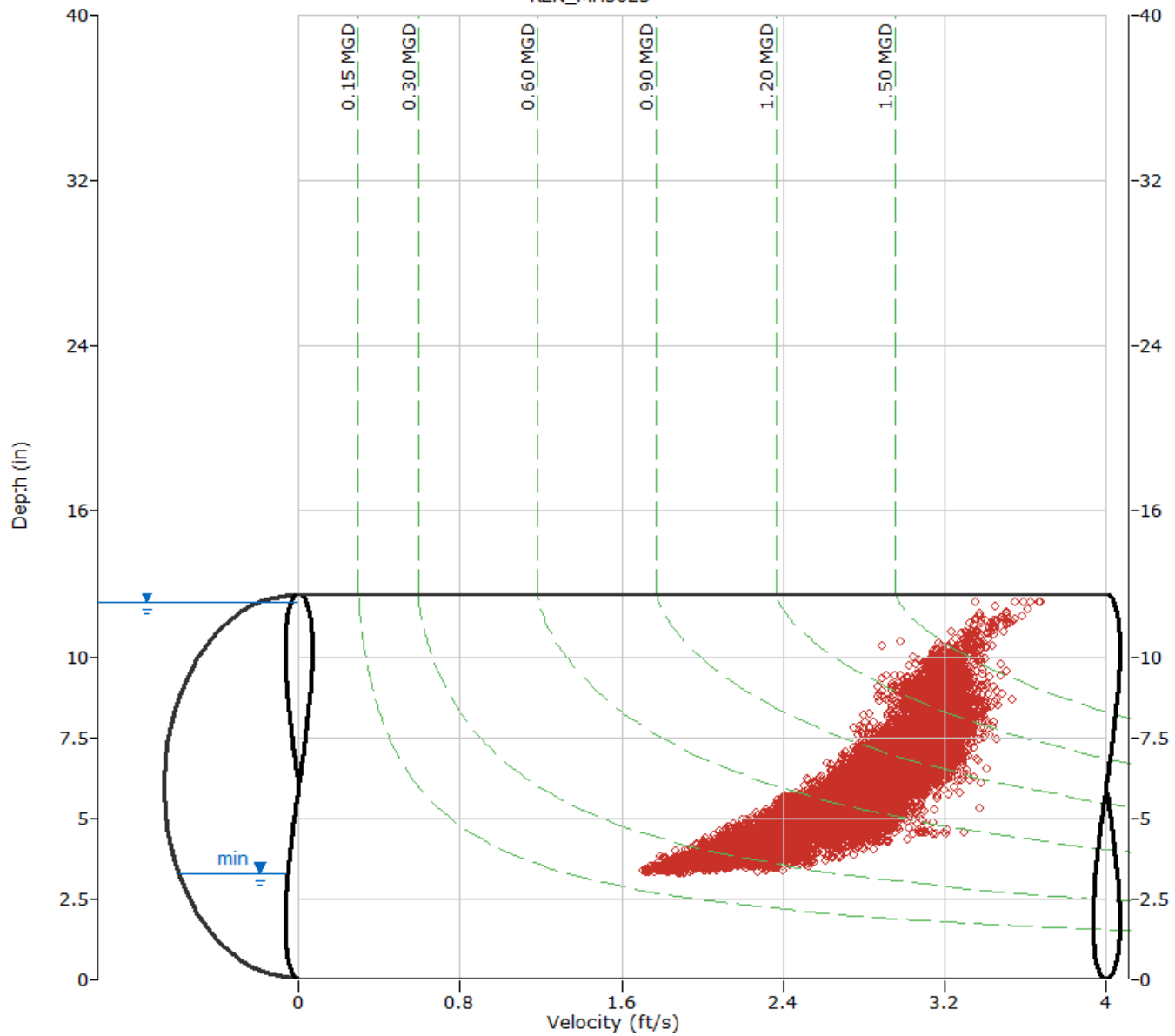

ADS Environmental Services

Pipe Height: 12.00

Date	REN_MH3625\mp1\DFINAL (inches)					REN_MH3625\mp1\VFINAL (feet/sec)					REN_MH3625\mp1\QFINAL (MGD - Total MG)						REN_RG\mp1\RAIN (inches)	
	Time	Min.	Time	Max.	Average	Time	Min.	Time	Max.	Average	Time	Min.	Time	Max.	Average	Total	Total	
12/22/2017	3:40	4.5	10:40	8.6	5.8	2:55	2.4	11:35	3.3	2.8	3:40	0.418	10:40	1.237	0.683	0.683	0.10	
12/23/2017	3:40	4.3	11:50	8.6	5.7	4:55	2.1	11:00	3.3	2.7	4:55	0.346	13:35	1.243	0.656	0.656	0.00	
12/24/2017	4:30	3.9	11:10	9.0	5.5	4:20	2.2	14:15	3.3	2.7	4:20	0.320	11:10	1.324	0.625	0.625	0.00	
12/25/2017	4:55	3.8	10:50	8.4	5.3	5:45	2.2	13:15	3.3	2.7	4:55	0.306	10:50	1.229	0.595	0.595	0.14	
12/26/2017	4:30	3.9	9:20	7.9	5.3	5:10	2.1	20:05	3.3	2.6	4:25	0.301	17:55	1.147	0.579	0.579	0.17	
12/27/2017	3:50	3.7	20:30	7.8	5.2	3:45	2.1	18:00	3.1	2.5	3:45	0.279	20:30	1.066	0.546	0.546	0.00	
12/28/2017	4:05	3.6	22:20	7.8	5.2	4:15	2.0	11:55	3.2	2.5	4:15	0.264	22:20	1.098	0.553	0.553	0.25	
12/29/2017	2:50	4.6	11:50	11.4	7.8	2:05	2.3	11:50	3.5	3.0	2:50	0.418	11:50	1.746	1.043	1.043	1.57	
12/30/2017	23:50	6.3	10:20	10.3	7.4	5:40	2.8	10:20	3.3	3.1	5:35	0.798	10:20	1.544	0.995	0.995	0.02	
12/31/2017	4:50	5.3	13:30	9.6	6.6	6:40	2.7	22:00	3.4	3.0	5:45	0.592	14:15	1.400	0.852	0.852	0.00	
ReportAvg	6.0					2.8					0.713							
ReportTotal											7.126						2.25	

ADS Environmental Services

Pipe Height: 12.00

Date	REN_MH3625\mp1\DFINAL (inches)					REN_MH3625\mp1\VFINAL (feet/sec)					REN_MH3625\mp1\QFINAL (MGD - Total MG)					REN_RG\mp1\RAIN (inches)	
	Time	Min.	Time	Max.	Average	Time	Min.	Time	Max.	Average	Time	Min.	Time	Max.	Average	Total	Total
1/1/2018	6:25	4.7	15:25	9.0	6.1	3:35	2.5	21:30	3.4	2.9	6:20	0.476	21:30	1.324	0.751	0.751	0.00
1/2/2018	3:45	4.5	20:35	8.5	5.7	3:30	2.3	19:35	3.4	2.8	3:30	0.400	19:35	1.300	0.666	0.666	0.01
1/3/2018	3:50	4.1	20:35	8.7	5.5	5:05	2.1	20:35	3.4	2.7	3:50	0.330	20:35	1.337	0.636	0.636	0.00
1/4/2018	3:45	4.2	19:40	8.2	5.4	3:45	2.2	19:40	3.3	2.7	3:45	0.342	19:40	1.227	0.617	0.617	0.09
1/5/2018	2:20	4.0	18:40	8.2	5.5	3:20	2.2	18:40	3.4	2.8	3:20	0.326	18:40	1.253	0.632	0.632	0.42
1/6/2018	3:10	4.4	12:05	9.1	6.0	3:20	2.5	10:40	3.3	2.9	3:10	0.421	12:05	1.277	0.745	0.745	0.24
1/7/2018	4:20	4.4	19:45	9.4	6.1	2:55	2.5	9:55	3.4	2.9	4:20	0.440	9:55	1.387	0.764	0.764	0.38
1/8/2018	3:00	5.0	20:40	9.2	6.4	16:30	2.6	19:55	3.3	2.9	3:00	0.526	19:00	1.340	0.808	0.808	0.14
1/9/2018	4:00	5.2	19:30	9.7	6.7	4:20	2.5	17:35	3.3	3.0	4:20	0.539	6:00	1.419	0.875	0.875	0.46
1/10/2018	4:15	5.5	21:55	9.4	6.6	15:00	2.7	0:25	3.4	2.9	4:25	0.630	19:10	1.313	0.850	0.850	0.22
1/11/2018	3:20	5.2	20:45	11.6	7.6	4:40	2.6	19:55	3.5	3.1	3:20	0.552	20:45	1.730	1.047	1.047	1.04
1/12/2018	4:00	6.7	8:00	10.3	7.5	22:40	2.9	11:55	3.4	3.2	4:15	0.880	7:15	1.536	1.061	1.061	0.20
1/13/2018	5:10	6.0	10:50	10.8	7.1	7:00	2.8	11:00	3.3	3.1	3:30	0.723	10:50	1.591	0.959	0.959	0.02
1/14/2018	4:40	5.4	11:10	9.7	6.7	4:10	2.6	9:40	3.4	3.0	4:05	0.594	10:25	1.388	0.872	0.872	0.00
1/15/2018	3:50	5.0	11:10	9.0	6.4	5:50	2.6	16:30	3.3	2.9	3:25	0.523	19:15	1.298	0.802	0.802	0.04
1/16/2018	4:05	4.7	19:40	9.0	6.1	4:30	2.5	18:45	3.3	2.9	4:20	0.479	7:30	1.285	0.750	0.750	0.26
1/17/2018	3:35	4.5	22:05	9.9	6.2	14:55	2.5	6:40	3.3	2.9	3:35	0.437	22:05	1.444	0.770	0.770	0.79
1/18/2018	1:50	5.8	7:15	10.2	7.4	13:30	2.8	7:25	3.3	3.0	2:45	0.682	7:15	1.522	0.981	0.981	0.40
1/19/2018	3:20	5.8	7:15	9.5	6.9	3:30	2.8	12:20	3.3	3.0	3:20	0.682	7:15	1.325	0.905	0.905	0.10
1/20/2018	3:55	5.4	10:05	9.6	6.7	2:25	2.6	10:10	3.3	2.9	4:15	0.587	10:05	1.347	0.852	0.852	0.10
1/21/2018	4:15	4.9	18:55	9.3	6.5	4:10	2.4	19:00	3.3	2.9	4:10	0.472	20:30	1.347	0.818	0.818	0.16
1/22/2018	1:20	4.9	21:05	9.2	6.4	1:30	2.5	10:40	3.3	2.9	2:25	0.486	21:05	1.295	0.799	0.799	0.34
1/23/2018	2:30	4.9	21:20	10.2	6.7	3:10	2.5	14:45	3.3	3.0	3:10	0.501	21:20	1.460	0.859	0.859	0.79
1/24/2018	3:00	6.5	19:15	10.8	7.8	0:40	2.8	9:30	3.4	3.1	3:05	0.840	19:15	1.602	1.087	1.087	0.51
1/25/2018	23:35	6.5	8:05	10.3	7.4	10:05	2.9	23:55	3.3	3.1	3:45	0.827	8:05	1.527	1.018	1.018	0.14
1/26/2018	3:20	5.7	21:10	9.4	6.9	2:55	2.6	13:25	3.4	3.1	2:55	0.642	13:20	1.402	0.924	0.924	0.36
1/27/2018	0:55	6.5	11:35	11.2	8.0	23:55	2.9	11:35	3.5	3.2	23:55	0.836	11:35	1.731	1.138	1.138	0.61
1/28/2018	4:55	6.5	12:10	10.7	7.4	4:55	2.9	22:05	3.4	3.1	4:55	0.797	12:10	1.588	1.029	1.029	0.07
1/29/2018	2:30	5.7	20:45	11.7	7.6	12:40	2.7	20:45	3.5	3.1	2:30	0.673	20:45	1.791	1.061	1.061	0.90
1/30/2018	23:40	6.5	7:15	10.3	7.5	6:50	2.8	17:55	3.4	3.2	23:55	0.840	7:15	1.517	1.055	1.055	0.00
1/31/2018	2:30	5.9	21:15	9.6	6.7	12:50	2.6	5:55	3.3	3.1	2:10	0.726	21:15	1.411	0.899	0.899	0.00
ReportAvg	6.7					3.0					0.872						
ReportTotal																27.03	8.79

ADS Environmental Services

Pipe Height: 12.00

Date	REN_MH3625\mp1\DFINAL (inches)					REN_MH3625\mp1\VFINAL (feet/sec)					REN_MH3625\mp1\QFINAL (MGD - Total MG)					REN_RG\mp1\RAIN (inches)	
	Time	Min.	Time	Max.	Average	Time	Min.	Time	Max.	Average	Time	Min.	Time	Max.	Average	Total	Total
2/1/2018	2:35	5.2	21:20	9.8	6.5	13:35	2.6	13:55	3.3	3.0	2:40	0.555	21:20	1.434	0.835	0.835	0.66
2/2/2018	4:05	5.9	6:50	9.2	6.8	4:05	2.8	23:25	3.4	3.1	4:05	0.694	7:35	1.318	0.916	0.916	0.04
2/3/2018	4:20	5.4	9:55	9.8	6.8	4:45	2.7	18:05	3.3	3.0	4:10	0.611	9:55	1.422	0.896	0.896	0.31
2/4/2018	4:20	5.7	14:30	10.1	7.0	6:40	2.6	9:20	3.4	3.0	4:20	0.652	14:30	1.487	0.934	0.934	0.02
2/5/2018	3:15	5.2	20:35	9.1	6.4	2:20	2.6	13:50	3.3	3.0	3:15	0.561	20:35	1.286	0.818	0.818	0.04
2/6/2018	3:50	4.8	20:40	9.0	6.1	3:10	2.5	6:50	3.3	2.9	3:10	0.488	6:50	1.338	0.753	0.753	0.00
2/7/2018	2:30	4.6	7:30	8.6	5.8	2:35	2.5	1:20	3.3	2.9	2:35	0.453	8:25	1.207	0.708	0.708	0.00
2/8/2018	4:10	4.4	20:25	8.7	5.7	2:30	2.4	8:50	3.3	2.8	3:25	0.420	20:25	1.256	0.678	0.678	0.09
2/9/2018	3:30	4.3	8:15	8.4	5.5	2:20	2.4	18:45	3.3	2.8	2:15	0.399	8:15	1.242	0.648	0.648	0.01
2/10/2018	3:50	4.2	10:25	9.0	5.6	3:05	2.3	20:20	3.3	2.7	3:50	0.366	10:25	1.211	0.653	0.653	0.01
2/11/2018	4:15	4.0	18:40	8.3	5.6	4:05	2.1	19:30	3.3	2.8	4:05	0.323	18:40	1.199	0.659	0.659	0.00
2/12/2018	2:05	3.9	7:20	8.1	5.3	2:50	2.1	11:25	3.2	2.7	3:50	0.310	7:20	1.172	0.582	0.582	0.00
2/13/2018	3:50	3.8	21:15	7.8	5.2	2:10	2.1	16:20	3.3	2.7	2:10	0.297	21:15	1.106	0.572	0.572	0.17
2/14/2018	3:00	3.8	21:10	8.5	5.2	4:05	2.1	21:10	3.3	2.7	2:40	0.302	21:10	1.251	0.584	0.584	0.15
2/15/2018	2:20	3.9	7:15	8.0	5.2	2:45	2.1	18:25	3.3	2.6	2:40	0.307	7:15	1.110	0.565	0.565	0.00
2/16/2018	4:15	3.9	19:50	7.5	5.2	1:50	2.1	6:05	3.3	2.6	2:30	0.314	6:05	1.010	0.564	0.564	0.15
2/17/2018	2:55	3.9	9:50	8.1	5.6	3:25	2.1	10:40	3.3	2.7	3:25	0.304	9:50	1.154	0.645	0.645	0.32
2/18/2018	4:25	4.0	11:35	8.2	5.5	6:30	2.3	16:35	3.2	2.7	4:25	0.344	11:35	1.159	0.619	0.619	0.01
2/19/2018	3:30	4.0	20:10	7.9	5.3	3:55	2.1	14:35	3.3	2.7	3:55	0.313	20:10	1.116	0.597	0.597	0.00
2/20/2018	3:20	3.8	9:50	7.2	5.1	4:50	2.2	18:00	3.2	2.7	3:20	0.312	16:55	1.002	0.561	0.561	0.00
2/21/2018	3:00	3.7	18:50	7.2	5.0	3:00	2.1	22:00	3.2	2.6	3:00	0.273	18:50	1.020	0.536	0.536	0.00
2/22/2018	3:25	3.7	20:15	7.2	5.0	2:40	2.0	13:45	3.2	2.6	2:40	0.276	20:15	0.999	0.531	0.531	0.07
2/23/2018	2:55	3.5	19:50	7.3	4.9	3:15	2.0	18:45	3.2	2.6	3:30	0.251	19:50	1.027	0.517	0.517	0.01
2/24/2018	3:00	3.6	10:45	8.1	4.9	0:20	2.1	12:35	3.2	2.7	3:00	0.270	10:45	1.178	0.534	0.534	0.13
2/25/2018	4:30	3.6	11:20	8.1	5.2	3:25	2.2	10:35	3.3	2.7	4:10	0.294	10:35	1.199	0.586	0.586	0.11
2/26/2018	3:20	3.5	6:55	7.9	5.0	3:05	1.9	21:05	3.3	2.6	3:05	0.247	21:05	1.168	0.524	0.524	0.00
2/27/2018	3:45	3.4	20:10	8.2	4.9	3:15	2.1	7:15	3.3	2.6	3:15	0.249	20:10	1.096	0.524	0.524	0.19
2/28/2018	3:25	3.5	20:40	8.8	5.2	3:05	2.1	15:30	3.2	2.6	3:05	0.259	20:40	1.181	0.556	0.556	0.35
ReportAvg	5.6					2.7					0.646						
ReportTotal																18.10	2.84

ADS Environmental Services

Pipe Height: 12.00

Date	REN_MH3625\mp1\DFINAL (inches)					REN_MH3625\mp1\VFINAL (feet/sec)					REN_MH3625\mp1\QFINAL (MGD - Total MG)						REN_RG\mp1\RAIN (inches)		
	Time	Min.	Time	Max.	Average	Time	Min.	Time	Max.	Average	Time	Min.	Time	Max.	Average	Total	Total		
3/1/2018	3:40	4.0	20:55	8.3	5.4	3:25	2.1	19:05	3.2	2.7	3:25	0.304	20:05	1.102	0.593	0.593	0.01		
3/2/2018	3:20	4.0	20:40	7.7	5.3	3:00	2.2	9:05	3.2	2.7	3:05	0.328	9:05	1.076	0.593	0.593	0.07		
3/3/2018	4:05	4.0	9:45	8.1	5.4	3:15	2.1	16:50	3.2	2.7	3:15	0.309	9:45	1.135	0.600	0.600	0.00		
3/4/2018	4:45	3.8	20:35	8.1	5.4	4:50	2.0	14:15	3.2	2.7	4:50	0.279	10:00	1.089	0.606	0.606	0.12		
3/5/2018	3:45	3.8	21:15	8.0	5.1	4:15	2.0	20:20	3.1	2.6	3:40	0.278	21:15	1.121	0.553	0.553	0.00		
3/6/2018	2:45	3.7	8:10	7.8	5.1	2:40	2.0	7:20	3.2	2.6	2:40	0.263	7:20	1.102	0.540	0.540	0.00		
3/7/2018	2:40	3.6	21:05	7.6	5.1	1:50	2.0	6:40	3.1	2.6	2:40	0.260	21:05	1.046	0.532	0.532	0.03		
3/8/2018	2:00	3.7	21:05	8.0	5.2	5:10	2.0	6:25	3.2	2.6	3:25	0.277	19:20	1.118	0.555	0.555	0.37		
3/9/2018	2:45	3.8	20:25	7.7	5.2	2:55	2.2	8:40	3.1	2.6	2:55	0.305	8:40	1.060	0.566	0.566	0.00		
3/10/2018	4:15	3.8	10:20	8.7	5.3	3:15	2.1	8:45	3.1	2.6	3:50	0.296	10:20	1.163	0.578	0.578	0.00		
3/11/2018	4:35	3.6	19:45	7.8	5.3	4:25	2.0	18:05	3.2	2.6	4:25	0.261	19:45	1.104	0.576	0.576	0.00		
3/12/2018	1:25	3.6	20:00	8.3	5.1	3:35	2.0	20:50	3.1	2.5	1:55	0.258	20:00	1.142	0.529	0.529	0.00		
3/13/2018	2:35	3.5	18:40	8.4	5.1	2:50	1.8	17:50	3.1	2.5	2:50	0.231	18:40	1.124	0.522	0.522	0.31		
3/14/2018	2:20	3.6	20:35	7.9	5.1	2:15	1.9	6:30	3.1	2.5	2:15	0.247	20:35	1.045	0.528	0.528	0.04		
3/15/2018	2:25	3.6	20:10	7.7	5.1	2:55	2.0	20:10	3.2	2.5	2:25	0.259	20:10	1.089	0.532	0.532	0.00		
3/16/2018	2:20	3.4	17:15	7.5	5.0	2:10	1.9	5:30	3.1	2.5	2:10	0.228	17:15	1.006	0.514	0.514	0.00		
3/17/2018	4:20	3.7	8:55	8.6	5.2	1:40	1.8	21:10	3.1	2.5	1:25	0.245	8:55	1.153	0.537	0.537	0.00		
3/18/2018	3:30	3.3	19:15	7.8	5.2	1:45	1.9	10:30	3.2	2.5	3:30	0.233	10:30	1.105	0.538	0.538	0.00		
3/19/2018	2:00	3.4	19:30	7.6	4.9	2:25	1.7	18:45	3.2	2.4	2:25	0.203	19:30	1.007	0.486	0.486	0.00		
3/20/2018	2:50	3.3	20:50	7.7	4.8	2:20	1.7	5:35	3.1	2.4	2:20	0.198	20:50	1.068	0.474	0.474	0.00		
3/21/2018	2:10	3.3	19:25	7.6	4.8	1:15	1.9	18:30	3.1	2.4	1:30	0.213	18:30	1.011	0.467	0.467	0.10		
3/22/2018	2:25	3.3	20:00	8.3	5.0	1:30	1.8	20:00	3.1	2.4	2:25	0.210	20:00	1.158	0.500	0.500	0.48		
3/23/2018	2:15	3.5	18:10	7.8	5.1	1:15	1.8	21:25	3.1	2.5	2:15	0.221	15:55	1.043	0.523	0.523	0.31		
3/24/2018	2:10	3.8	9:55	8.8	5.5	2:30	2.0	8:15	3.2	2.6	2:10	0.282	9:55	1.150	0.602	0.602	0.28		
3/25/2018	3:30	3.8	18:30	8.1	5.5	3:05	2.1	20:55	3.1	2.6	3:15	0.295	18:30	1.124	0.599	0.599	0.01		
3/26/2018	2:35	3.8	21:00	8.8	5.2	2:20	2.0	5:25	3.1	2.5	2:20	0.282	21:00	1.241	0.552	0.552	0.17		
3/27/2018	2:50	3.9	19:40	8.1	5.1	0:45	1.9	19:40	3.2	2.6	0:45	0.273	19:40	1.155	0.544	0.544	0.02		
3/28/2018	2:00	3.8	19:40	7.8	5.1	0:45	2.0	19:40	3.1	2.6	2:35	0.277	19:40	1.102	0.540	0.540	0.01		
3/29/2018	2:25	3.6	17:50	7.7	5.0	0:40	2.1	7:35	3.2	2.6	2:20	0.277	5:55	1.014	0.534	0.534	0.00		
3/30/2018	2:20	3.6	7:50	7.1	4.9	1:30	2.1	19:55	3.1	2.7	2:15	0.269	7:50	0.952	0.528	0.528	0.00		
3/31/2018	2:55	3.3	8:55	8.0	5.0	3:15	2.0	9:40	3.3	2.8	3:15	0.261	8:10	1.091	0.569	0.569	0.00		
ReportAvg					5.1					2.6							0.546		
ReportTotal																	16.91	2.33	

ADS Environmental Services

Pipe Height: 12.00

Date	REN_MH3625\mp1\DFINAL (inches)					REN_MH3625\mp1\VFINAL (feet/sec)					REN_MH3625\mp1\QFINAL (MGD - Total MG)						REN_RG\mp1\RAIN (inches)	
	Time	Min.	Time	Max.	Average	Time	Min.	Time	Max.	Average	Time	Min.	Time	Max.	Average	Total	Total	
4/1/2018	2:00	3.4	10:00	7.6	5.2	3:45	2.1	9:15	3.3	2.7	3:45	0.254	8:35	1.054	0.573	0.573	0.10	
4/2/2018	2:15	3.6	20:05	7.7	5.0	2:35	1.9	18:30	3.3	2.5	2:35	0.243	20:05	1.119	0.522	0.522	0.00	
4/3/2018	2:55	3.5	19:35	7.6	4.8	3:25	2.0	10:10	3.4	2.7	0:50	0.255	19:35	1.034	0.515	0.515	0.00	
4/4/2018	2:25	3.4	20:10	7.5	4.9	2:45	2.0	7:30	3.1	2.6	2:20	0.237	20:10	1.018	0.522	0.522	0.39	
4/5/2018	2:50	3.5	19:05	7.6	5.0	4:25	2.0	21:45	3.2	2.6	2:40	0.256	19:55	1.003	0.525	0.525	0.25	
4/6/2018	2:15	3.6	6:55	7.2	4.9	4:00	2.1	19:05	3.4	2.8	2:50	0.278	21:10	0.951	0.556	0.556	0.00	
4/7/2018	1:00	3.5	9:55	8.4	5.6	1:05	2.4	23:10	3.4	2.9	1:05	0.309	9:55	1.190	0.690	0.690	0.88	
4/8/2018	0:55	4.5	11:20	9.8	6.3	23:15	2.7	13:40	3.3	3.0	0:45	0.521	11:20	1.455	0.806	0.806	0.45	
4/9/2018	23:50	4.6	20:25	8.3	5.9	2:15	2.5	16:00	3.2	2.8	23:50	0.458	21:20	1.159	0.708	0.708	0.00	
4/10/2018	2:30	4.6	20:05	8.2	5.8	23:10	2.3	6:20	3.3	2.8	2:05	0.429	6:20	1.219	0.673	0.673	0.23	
4/11/2018	0:15	4.6	20:05	8.4	5.7	3:40	2.2	17:05	3.4	2.8	3:40	0.420	18:15	1.208	0.680	0.680	0.31	
4/12/2018	0:30	4.4	20:10	8.1	5.7	1:20	2.4	21:10	3.3	2.8	0:30	0.430	6:00	1.198	0.669	0.669	0.11	
4/13/2018	1:20	4.5	18:50	8.2	5.8	1:15	2.3	16:35	3.3	2.8	1:20	0.402	16:35	1.132	0.675	0.675	0.51	
4/14/2018	2:10	4.9	19:45	11.7	7.7	1:35	2.5	19:45	3.6	3.0	2:10	0.517	19:45	1.811	1.045	1.045	1.52	
4/15/2018	23:15	6.7	8:30	11.7	8.9	23:05	2.9	9:55	3.7	3.2	23:20	0.875	9:55	1.855	1.284	1.284	0.21	
4/16/2018	2:45	6.2	21:00	11.3	7.7	9:15	2.8	10:20	3.5	3.1	2:20	0.779	21:00	1.669	1.080	1.080	0.71	
4/17/2018	23:55	6.1	7:00	10.4	7.3	23:45	2.8	18:55	3.4	3.1	23:55	0.736	5:25	1.532	1.018	1.018	0.01	
4/18/2018	23:55	5.3	20:45	9.8	6.9	23:40	2.7	16:15	3.5	3.1	23:40	0.590	12:00	1.415	0.930	0.930	0.12	
4/19/2018	23:55	4.8	6:15	9.1	6.4	23:55	2.6	8:55	3.5	3.0	23:55	0.490	6:15	1.381	0.816	0.816	0.00	
4/20/2018	3:10	4.5	8:35	8.7	5.9	0:25	2.4	6:45	3.4	2.8	3:15	0.442	6:45	1.309	0.720	0.720	0.00	
4/21/2018	4:05	4.3	7:15	8.8	5.9	4:20	2.4	7:15	3.4	2.8	4:20	0.402	7:15	1.353	0.706	0.706	0.05	
4/22/2018	3:20	4.4	11:15	8.7	5.9	0:45	2.2	8:50	3.3	2.8	4:05	0.389	12:05	1.240	0.704	0.704	0.00	
ReportAvg	6.0					2.8					0.746							
ReportTotal											16.42						5.85	

REN_MH4628

Located At: 766 Monroe Ave NE (see attached site report for details)
Monitoring Period: December 22, 2017 – April 22, 2018
Pipe Dimensions: 10.38"
Finalized Silt Level: 0 mm

Site Data Characteristics: This site is located in a sanitary sewer pipe. The scattergraph indicates site operated in free flow conditions. The site did not surcharge during the monitoring period. The dry weather data plots above the Froude =1 curve indicating supercritical flow.

Site Data Bias & Editing: The depth and velocity measurements recorded by the flow monitor were consistent with field confirmations conducted to date and supported the relative accuracy of the flow monitor at this location. The finalized depth data utilized the upward ultrasonic sensor.

Site Data Uptime: The data uptime achieved during the monitoring period is provided in the table below. Based upon the quality and consistency of the observed flow depth and velocity data, the Continuity equation was used to calculate the flow rate for the monitoring period.

Entity	Percentage Uptime	
	Raw	Final
Depth (in)	100%	100%
Velocity (f/s)	100%	100%
Quantity (mgd)	100%	100%

Site Data Summary: The average flow depth, velocity, and quantity data observed during the monitoring period along with observed minimum and maximum data, are provided in the following table. The minimum and maximum rates recorded in the tables are based on 5-minute data intervals.

Item	Depth (in)	Velocity (f/s)	Quantity (mgd)	% Full
Minimum	1.45	2.46	0.086	14%
Maximum	3.86	6.75	0.787	37%
Average	2.11	4.64	0.261	20%

Renton.Carollo.I&I.WA17



Site Name

REN_MH4628

Flow Monitoring Site Report

Site Address /Location: 766 Monroe Ave NE

Monitor Series

Location Type

Site Access Details: Site located In roadway

Latitude: 47.495741°
Longitude: -122.175081°

TRITON+
Pipe Size (H x W)
10.38" x 10.00"

Temporary
Pipe Shape
Circular

Manhole #

System Characteristics

MH4628

Residential / Commercial

Access

Traffic

Drive

Medium

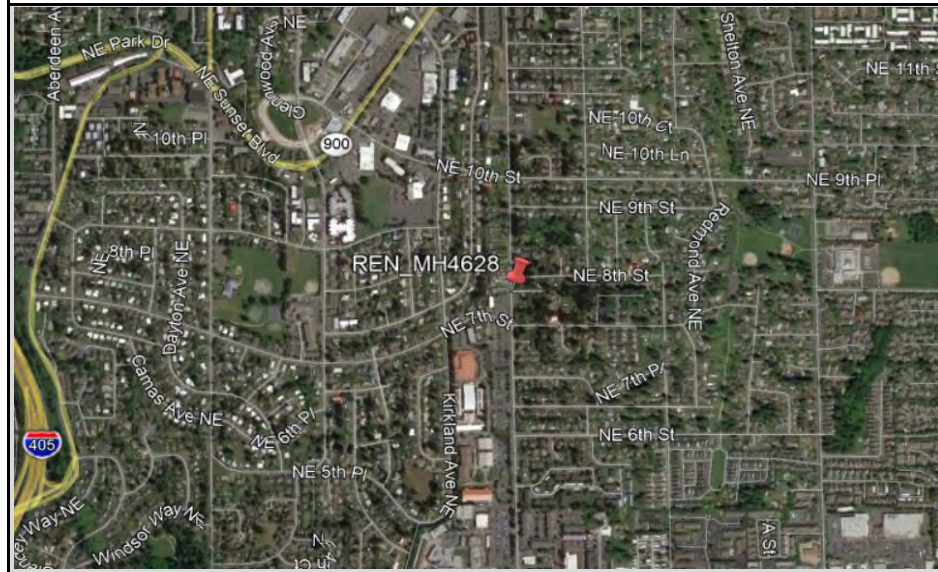

Installation Information

Installation Date:

Installation Type:

Wednesday, November 29, 2017

Doppler Standard Ring and Crank

Monitoring Location (Sensors):

Monitor Location:

Downstream 0-5 FT

Manhole

Sensors / Devices:

Pressure Sensor Range (psi)

Peak Combo (CS4), Smart Depth (CS5)

0 - 5 psi

Installation Confirmation:

Confirmation Time:

Pipe Size (HxW)

2:50:00 PM

10.38" x 10.00"

Depth of Flow (Wet DOF) (in)

2.38"

CS5 Physical Offset (in)

Measurement Confidence (in)

1.38"

0.25"

Peak Velocity (fps)

Velocity Sensor Offset (in)

3.00'

0"

Silt (in)

Silt Type

0.00"

Hydraulic Comments:

Straight, Some Ripples

Manhole / Pipe Information:

Manhole Depth (Approx. FT):

Manhole Configuration

13'

Sanitary Sewer Overflow

Manhole Material:

Manhole Condition:

Concrete

Good

Manhole Opening Diameter (in)

Manhole Diameter (Approx.):

20"

20"

Manhole Cover

Manhole Frame

Steel

Normal

Active Connections

Air Quality:

Yes, Inside

Normal

Pipe Material

Pipe Condition:

Vitrified Clay Pipe

Fair

Communication Information:

Communication Type

Antenna Location

Wireless

Manhole Pick / Vent Hole

Additional Site Info. / Comments:





Renton traffic control required.

ADS Project Name: Renton.Carollo.I&I.WA17

ADS Project Number: 22275.11.325

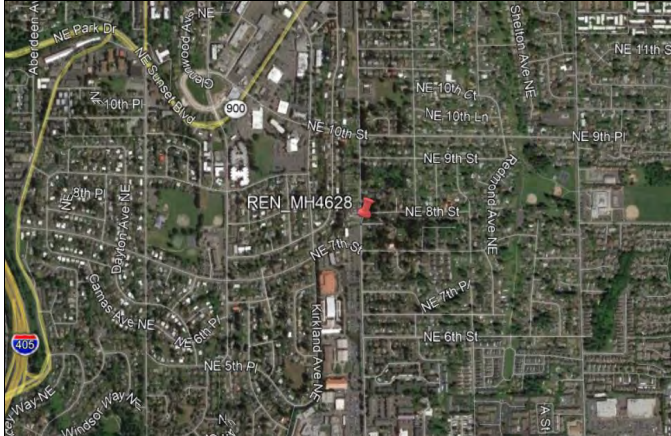

Additional Photos

Inlet	Outlet	Side connect
		
Top Down	Location	Location Map
		
	KEY	
	<p>→ Flow Direction</p> <p>⊗ Monitoring Point</p>	

HYDROGRAPH REPORT

REN_MH4628

Flow Monitor
REN_MH4628

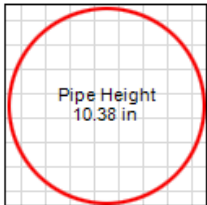

Report Period
12/22/2017
To
4/22/2018

Legend
— Depth
— Velocity
— Rain

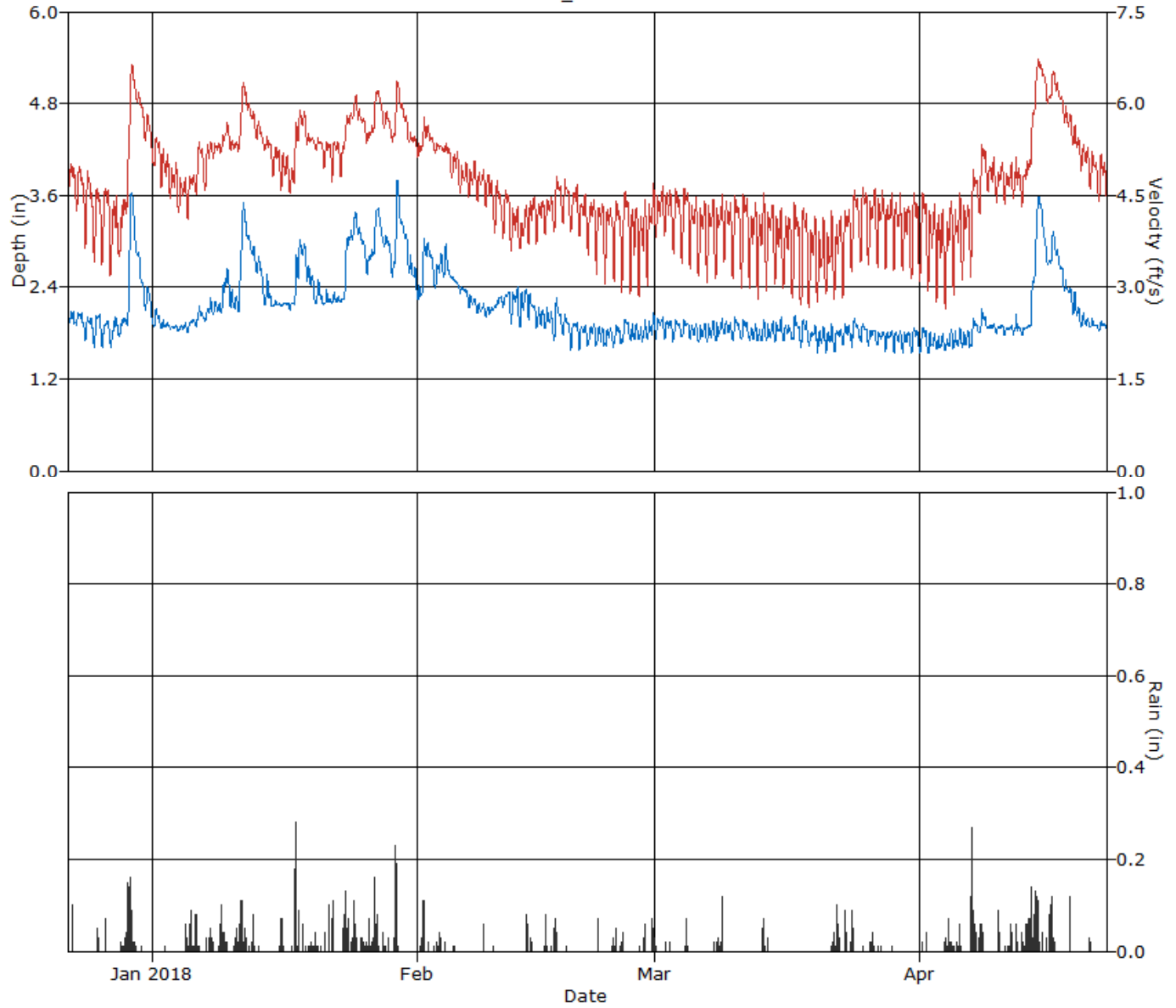

HYDROGRAPH REPORT

REN_MH4628

Flow Monitor
REN_MH4628

Pipe Height
10.38 in.

Report Period
12/22/2017
To
4/22/2018

Legend
— Quantity
— Rain

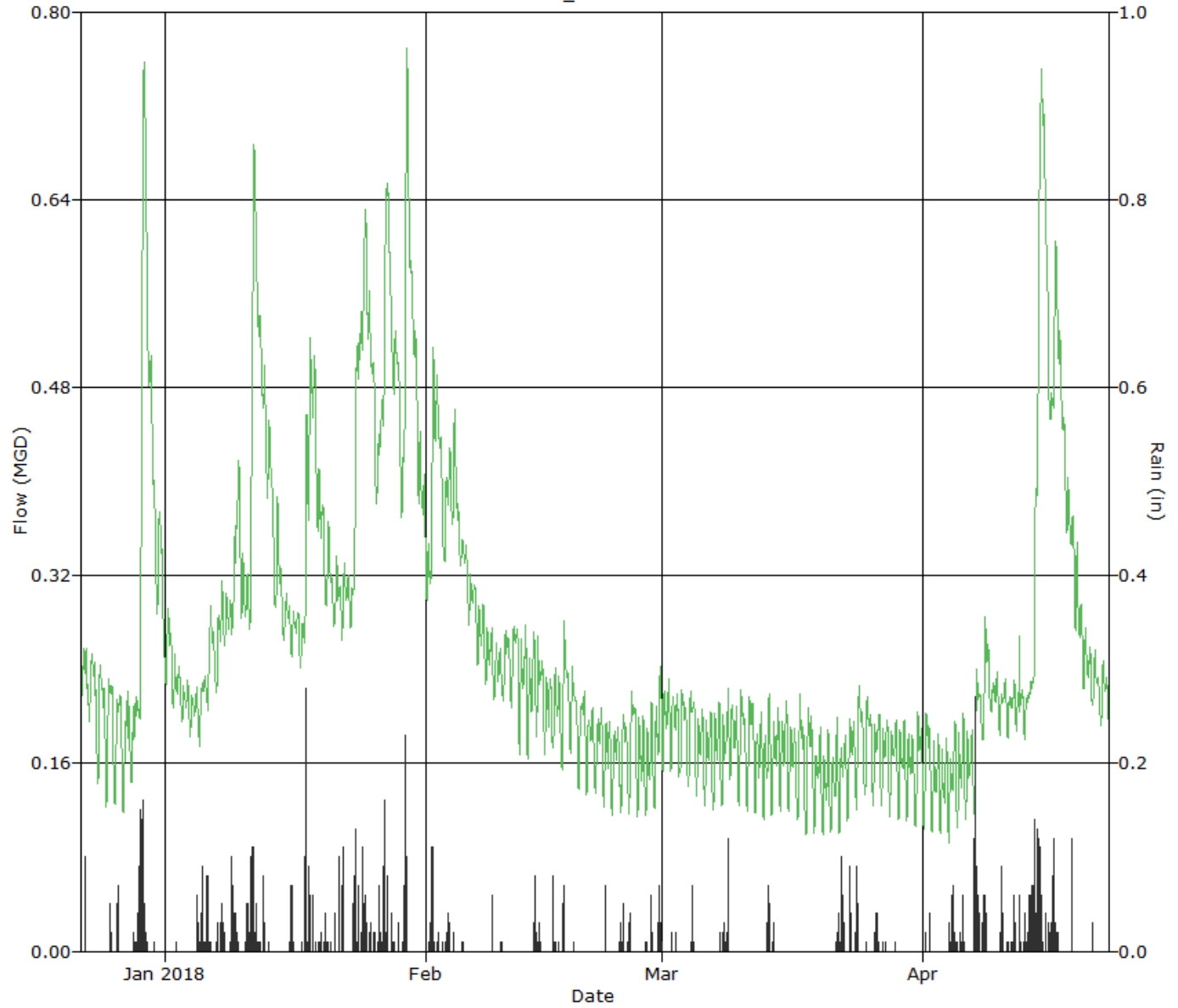

SCATTERGRAPH REPORT

REN_MH4628

Flow Monitor
REN_MH4628

Pipe Height
10.38 in

Report Period
12/22/2017
To
4/22/2018

Legend
○ Depth - Velocity
- - Iso-Q™
- - Silt
▼ Min-Max Depth

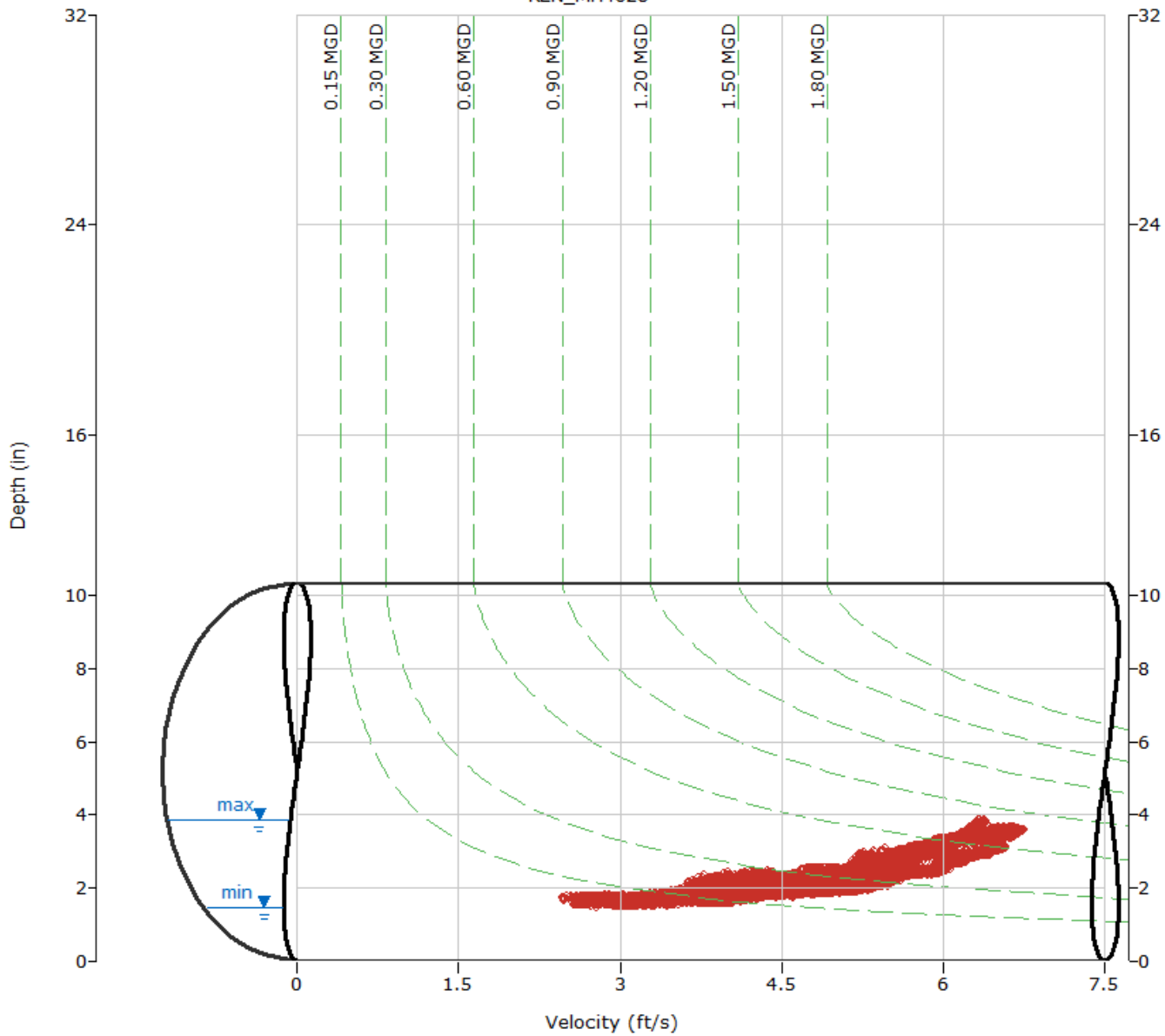

ADS Environmental Services

Pipe Height: 10.38

Date	REN_MH4628\mp1\DFINAL (inches)					REN_MH4628\mp1\VFINAL (feet/sec)					REN_MH4628\mp1\QFINAL (MGD - Total MG)					REN_RG\mp1\RAIN (inches)	
	Time	Min.	Time	Max.	Average	Time	Min.	Time	Max.	Average	Time	Min.	Time	Max.	Average	Total	Total
12/22/2017	0:10	1.8	17:30	2.2	2.0	0:10	4.2	16:15	5.1	4.8	0:10	0.184	17:30	0.272	0.233	0.233	0.10
12/23/2017	23:00	1.8	6:55	2.1	2.0	23:55	4.1	8:35	5.1	4.6	23:55	0.179	8:35	0.266	0.227	0.227	0.00
12/24/2017	0:25	1.6	9:00	2.1	1.9	0:25	3.5	8:45	5.1	4.4	0:25	0.131	8:45	0.260	0.201	0.201	0.00
12/25/2017	2:40	1.5	9:25	2.1	1.9	4:00	3.2	10:25	4.8	4.2	2:40	0.112	9:20	0.246	0.194	0.194	0.14
12/26/2017	3:35	1.5	17:40	2.0	1.8	1:30	3.0	13:40	4.8	4.1	3:40	0.112	13:40	0.234	0.182	0.182	0.17
12/27/2017	1:05	1.6	13:05	2.1	1.8	0:20	3.0	17:25	4.7	3.9	2:30	0.112	17:25	0.235	0.172	0.172	0.00
12/28/2017	0:20	1.7	17:55	2.0	1.9	0:20	3.3	17:55	4.7	4.1	0:20	0.128	17:55	0.235	0.191	0.191	0.25
12/29/2017	0:05	1.9	13:40	3.7	3.0	1:10	4.0	14:40	6.7	6.0	1:10	0.184	13:40	0.768	0.549	0.549	1.57
12/30/2017	23:55	2.3	0:05	2.9	2.7	23:55	5.6	9:30	6.2	6.0	23:55	0.333	0:05	0.525	0.446	0.446	0.02
12/31/2017	23:00	2.0	11:55	2.4	2.2	23:00	5.1	11:55	6.0	5.5	23:00	0.244	11:55	0.389	0.318	0.318	0.00
ReportAvg	2.1					4.8					0.271						
ReportTotal																2.713	2.25

ADS Environmental Services

Pipe Height: 10.38

Date	REN_MH4628\mp1\DFINAL (inches)					REN_MH4628\mp1\VFINAL (feet/sec)					REN_MH4628\mp1\QFINAL (MGD - Total MG)					REN_RG\mp1\RAIN (inches)	
	Time	Min.	Time	Max.	Average	Time	Min.	Time	Max.	Average	Time	Min.	Time	Max.	Average	Total	Total
1/1/2018	23:40	1.9	11:35	2.2	2.0	22:40	4.6	11:35	5.5	5.2	23:35	0.209	11:35	0.302	0.253	0.253	0.00
1/2/2018	3:55	1.9	5:55	2.0	1.9	23:35	4.5	17:50	5.4	4.9	23:40	0.200	17:50	0.263	0.226	0.226	0.01
1/3/2018	23:55	1.8	18:30	1.9	1.9	23:30	4.3	19:10	5.1	4.7	23:30	0.184	18:20	0.235	0.213	0.213	0.00
1/4/2018	0:20	1.8	20:35	1.9	1.9	0:50	4.0	19:45	5.0	4.6	0:50	0.175	19:45	0.234	0.207	0.207	0.09
1/5/2018	3:15	1.8	19:45	2.0	1.9	4:15	3.9	20:25	5.0	4.6	4:15	0.164	20:25	0.244	0.213	0.213	0.42
1/6/2018	2:55	1.9	12:30	2.2	2.0	3:35	4.4	11:55	5.4	5.0	3:35	0.200	12:35	0.307	0.253	0.253	0.24
1/7/2018	5:00	1.9	19:15	2.3	2.1	3:55	4.4	21:30	5.4	5.1	3:55	0.213	19:20	0.322	0.265	0.265	0.38
1/8/2018	4:05	2.0	20:10	2.3	2.1	3:10	5.0	20:10	5.4	5.3	3:10	0.254	20:10	0.327	0.283	0.283	0.14
1/9/2018	0:30	2.0	20:05	2.7	2.4	0:30	5.1	20:00	5.8	5.5	0:30	0.262	20:05	0.443	0.347	0.347	0.46
1/10/2018	15:15	2.1	7:30	2.4	2.2	15:00	5.2	8:10	5.5	5.3	13:50	0.277	7:30	0.350	0.305	0.305	0.22
1/11/2018	2:05	2.1	15:50	3.6	2.9	4:00	5.1	14:40	6.4	5.9	3:30	0.270	15:50	0.709	0.499	0.499	1.04
1/12/2018	18:25	2.8	0:00	3.1	3.0	18:30	5.7	0:00	6.1	5.9	18:30	0.450	0:00	0.568	0.506	0.506	0.20
1/13/2018	23:35	2.4	10:45	2.8	2.6	23:30	5.3	9:50	5.8	5.5	23:35	0.340	9:50	0.464	0.407	0.407	0.02
1/14/2018	23:55	2.1	10:45	2.6	2.3	23:30	5.1	11:20	5.6	5.3	23:30	0.280	10:45	0.399	0.320	0.320	0.00
1/15/2018	2:10	2.1	12:50	2.3	2.2	23:55	4.6	10:20	5.3	5.1	23:55	0.255	10:40	0.311	0.282	0.282	0.04
1/16/2018	0:50	2.1	13:15	2.2	2.2	2:10	4.4	21:05	5.3	4.9	2:10	0.239	19:20	0.298	0.275	0.275	0.26
1/17/2018	2:30	2.1	20:20	2.8	2.3	4:45	4.4	21:10	5.8	5.0	3:50	0.236	20:25	0.466	0.304	0.304	0.79
1/18/2018	2:35	2.5	7:20	3.0	2.8	1:50	5.3	7:45	5.9	5.7	2:35	0.360	7:05	0.527	0.465	0.465	0.40
1/19/2018	23:35	2.3	0:00	2.7	2.5	4:05	5.3	7:50	5.6	5.4	23:35	0.322	0:00	0.434	0.376	0.376	0.10
1/20/2018	3:20	2.2	11:05	2.6	2.3	5:20	5.2	10:15	5.5	5.3	5:20	0.291	11:05	0.385	0.319	0.319	0.10
1/21/2018	1:40	2.2	11:05	2.4	2.2	23:40	4.8	9:35	5.4	5.2	3:15	0.271	11:05	0.350	0.300	0.300	0.16
1/22/2018	1:10	2.2	7:10	2.4	2.2	5:00	4.6	18:35	5.5	5.2	1:20	0.259	7:15	0.340	0.301	0.301	0.34
1/23/2018	1:50	2.2	19:45	3.0	2.5	3:55	4.6	19:55	5.9	5.3	3:55	0.266	19:55	0.523	0.365	0.365	0.79
1/24/2018	0:15	3.0	20:55	3.4	3.2	2:25	5.6	16:00	6.3	5.9	0:15	0.485	20:50	0.643	0.555	0.555	0.51
1/25/2018	23:55	2.8	0:00	3.2	3.0	23:15	5.4	0:25	6.0	5.8	23:50	0.434	0:00	0.585	0.515	0.515	0.14
1/26/2018	4:10	2.5	18:50	2.9	2.8	3:50	5.3	13:25	5.7	5.5	3:55	0.371	18:50	0.475	0.430	0.430	0.36
1/27/2018	0:00	2.8	12:45	3.4	3.2	0:10	5.5	9:50	6.3	6.0	0:10	0.445	12:45	0.665	0.590	0.590	0.61
1/28/2018	23:55	2.7	9:50	3.1	3.0	23:40	5.5	9:15	5.9	5.7	23:55	0.412	9:10	0.538	0.493	0.493	0.07
1/29/2018	3:55	2.5	19:10	3.9	3.1	3:40	5.3	19:35	6.4	5.8	3:55	0.364	19:10	0.787	0.531	0.531	0.90
1/30/2018	23:50	2.8	0:05	3.4	3.1	23:45	5.5	0:20	6.2	5.8	23:45	0.441	0:05	0.642	0.545	0.545	0.00
1/31/2018	23:40	2.4	7:35	2.8	2.6	23:05	5.3	6:55	5.6	5.4	23:40	0.336	6:55	0.452	0.393	0.393	0.00
ReportAvg	2.5					5.4					0.366						
ReportTotal																11.34	8.79

ADS Environmental Services

Pipe Height: 10.38

Date	REN_MH4628\mp1\DFINAL (inches)					REN_MH4628\mp1\VFINAL (feet/sec)					REN_MH4628\mp1\QFINAL (MGD - Total MG)						REN_RG\mp1\RAIN (inches)	
	Time	Min.	Time	Max.	Average	Time	Min.	Time	Max.	Average	Time	Min.	Time	Max.	Average	Total	Total	
2/1/2018	3:55	2.2	22:05	3.0	2.5	4:50	5.1	22:40	5.8	5.3	3:55	0.294	22:05	0.522	0.358	0.358	0.66	
2/2/2018	23:40	2.6	6:45	3.0	2.8	22:10	5.3	9:10	5.7	5.5	23:40	0.374	7:40	0.496	0.443	0.443	0.04	
2/3/2018	5:40	2.4	21:35	2.9	2.6	5:35	5.1	10:00	5.4	5.3	5:35	0.326	21:35	0.441	0.381	0.381	0.31	
2/4/2018	23:45	2.5	10:35	3.1	2.7	23:30	5.0	10:35	5.5	5.2	23:40	0.341	10:35	0.492	0.388	0.388	0.02	
2/5/2018	23:50	2.4	5:30	2.5	2.5	3:30	4.7	19:10	5.3	5.0	23:50	0.307	7:50	0.358	0.336	0.336	0.04	
2/6/2018	2:45	2.3	7:40	2.4	2.4	3:55	4.4	18:50	5.2	4.8	3:55	0.269	7:00	0.325	0.302	0.302	0.00	
2/7/2018	3:30	2.1	7:55	2.3	2.2	4:10	4.4	19:10	5.2	4.8	4:10	0.238	19:20	0.303	0.271	0.271	0.00	
2/8/2018	2:05	2.1	7:30	2.2	2.1	3:50	4.3	19:00	5.0	4.7	3:50	0.223	22:05	0.282	0.254	0.254	0.09	
2/9/2018	4:00	2.0	19:35	2.2	2.1	4:00	4.2	10:05	5.0	4.6	4:00	0.208	10:05	0.281	0.239	0.239	0.01	
2/10/2018	2:15	2.1	17:50	2.3	2.2	4:35	3.8	10:35	5.0	4.4	2:15	0.206	11:05	0.285	0.246	0.246	0.01	
2/11/2018	4:35	2.1	21:05	2.4	2.3	4:40	3.6	9:20	4.7	4.3	4:40	0.195	18:50	0.280	0.252	0.252	0.00	
2/12/2018	2:10	1.9	20:15	2.4	2.2	3:50	3.5	20:20	4.4	4.0	3:50	0.162	20:20	0.289	0.230	0.230	0.00	
2/13/2018	2:55	1.9	8:10	2.4	2.2	4:10	3.4	19:10	4.4	4.0	4:10	0.153	19:10	0.281	0.221	0.221	0.17	
2/14/2018	4:35	1.9	7:35	2.3	2.1	3:10	3.6	19:20	4.6	4.2	4:15	0.175	7:35	0.277	0.229	0.229	0.15	
2/15/2018	3:50	1.9	7:35	2.2	2.0	2:55	3.5	20:10	4.5	4.2	2:55	0.158	7:35	0.243	0.209	0.209	0.00	
2/16/2018	23:50	1.8	8:50	2.2	2.0	0:55	3.7	19:35	4.5	4.2	2:10	0.164	7:55	0.249	0.207	0.207	0.15	
2/17/2018	4:30	1.7	9:40	2.3	2.0	2:50	3.7	10:25	4.8	4.4	2:50	0.149	9:40	0.284	0.222	0.222	0.32	
2/18/2018	4:15	1.8	10:40	2.1	1.9	4:55	4.0	10:35	4.9	4.4	4:15	0.164	10:40	0.250	0.207	0.207	0.01	
2/19/2018	3:00	1.6	19:15	2.0	1.8	2:35	3.8	19:15	4.8	4.3	3:00	0.134	19:15	0.231	0.189	0.189	0.00	
2/20/2018	2:40	1.6	20:25	1.9	1.8	2:25	3.6	21:30	4.6	4.2	2:25	0.128	20:25	0.213	0.179	0.179	0.00	
2/21/2018	5:05	1.6	19:20	1.9	1.8	3:40	3.3	19:05	4.6	4.1	3:40	0.127	19:15	0.217	0.176	0.176	0.00	
2/22/2018	5:40	1.6	10:35	1.9	1.8	3:10	3.0	17:05	4.5	4.0	3:10	0.113	20:25	0.201	0.169	0.169	0.07	
2/23/2018	5:20	1.6	19:40	1.9	1.8	2:15	2.8	18:50	4.5	4.0	1:50	0.106	18:50	0.199	0.163	0.163	0.01	
2/24/2018	0:30	1.6	10:35	1.9	1.8	4:05	2.8	17:25	4.6	4.0	4:05	0.108	10:15	0.210	0.167	0.167	0.13	
2/25/2018	0:20	1.6	10:15	2.0	1.8	2:05	2.7	10:10	4.7	4.0	2:05	0.109	10:10	0.232	0.178	0.178	0.11	
2/26/2018	3:00	1.7	21:05	2.0	1.8	2:05	2.5	21:15	4.5	3.8	2:05	0.104	21:15	0.215	0.161	0.161	0.00	
2/27/2018	10:45	1.7	19:55	2.0	1.8	2:20	2.7	19:40	4.6	3.8	1:35	0.106	19:55	0.221	0.161	0.161	0.19	
2/28/2018	3:25	1.7	19:35	2.1	1.9	2:20	2.8	19:30	4.8	4.0	2:20	0.112	19:30	0.253	0.184	0.184	0.35	
ReportAvg	2.1					4.4					0.240							
ReportTotal																	6.722 2.84	

ADS Environmental Services

Pipe Height: 10.38

Date	REN_MH4628\mp1\DFINAL (inches)					REN_MH4628\mp1\VFINAL (feet/sec)					REN_MH4628\mp1\QFINAL (MGD - Total MG)					REN_RG\mp1\RAIN (inches)	
	Time	Min.	Time	Max.	Average	Time	Min.	Time	Max.	Average	Time	Min.	Time	Max.	Average	Total	Total
3/1/2018	2:40	1.7	21:20	2.1	1.9	4:00	3.5	19:40	4.9	4.3	3:25	0.147	21:15	0.244	0.199	0.199	0.01
3/2/2018	2:55	1.7	8:05	2.0	1.9	3:25	3.6	8:05	4.9	4.3	2:55	0.147	8:05	0.240	0.195	0.195	0.07
3/3/2018	1:30	1.7	9:55	2.0	1.9	4:00	3.4	13:40	4.7	4.2	1:10	0.142	9:45	0.230	0.191	0.191	0.00
3/4/2018	1:05	1.7	11:35	2.0	1.9	4:40	3.2	9:45	4.8	4.2	3:00	0.133	11:35	0.238	0.188	0.188	0.12
3/5/2018	0:50	1.7	19:50	1.9	1.8	4:15	3.0	20:05	4.6	4.0	4:15	0.118	20:05	0.214	0.175	0.175	0.00
3/6/2018	2:50	1.6	19:45	1.9	1.8	2:15	3.0	19:40	4.6	4.0	2:50	0.114	19:40	0.219	0.170	0.170	0.00
3/7/2018	2:15	1.7	19:45	2.0	1.8	2:10	2.7	21:25	4.6	4.0	2:10	0.105	21:25	0.218	0.171	0.171	0.03
3/8/2018	4:05	1.7	21:30	2.0	1.8	3:05	2.9	21:25	4.7	4.0	3:00	0.113	21:25	0.237	0.174	0.174	0.37
3/9/2018	23:35	1.8	9:25	2.0	1.9	3:20	3.3	9:25	4.6	4.1	3:20	0.137	9:25	0.222	0.182	0.182	0.00
3/10/2018	3:25	1.7	10:40	2.0	1.9	3:50	3.0	10:45	4.6	4.0	3:50	0.117	10:45	0.234	0.180	0.180	0.00
3/11/2018	5:10	1.7	9:25	2.0	1.9	3:50	2.7	9:10	4.7	4.0	3:50	0.110	9:30	0.224	0.178	0.178	0.00
3/12/2018	14:15	1.7	19:15	2.0	1.8	2:45	2.5	18:40	4.6	3.9	2:45	0.099	18:40	0.215	0.164	0.164	0.00
3/13/2018	11:00	1.7	18:55	2.0	1.8	1:25	2.5	18:15	4.6	3.9	2:40	0.097	18:45	0.223	0.164	0.164	0.31
3/14/2018	1:25	1.7	20:30	2.0	1.8	2:50	2.7	7:30	4.6	3.9	1:25	0.108	7:30	0.222	0.168	0.168	0.04
3/15/2018	1:25	1.7	19:55	2.0	1.8	1:20	2.8	17:45	4.5	3.8	1:20	0.105	19:50	0.224	0.170	0.170	0.00
3/16/2018	3:00	1.7	16:40	2.0	1.8	1:45	2.8	16:40	4.4	3.7	1:45	0.111	16:40	0.210	0.162	0.162	0.00
3/17/2018	22:30	1.7	11:05	2.1	1.8	4:25	2.5	9:15	4.5	3.7	3:35	0.102	9:15	0.230	0.165	0.165	0.00
3/18/2018	4:00	1.4	9:35	2.0	1.8	4:55	2.6	10:50	4.5	3.6	4:00	0.086	10:50	0.221	0.160	0.160	0.00
3/19/2018	2:05	1.5	19:30	2.0	1.8	1:55	2.6	19:20	4.5	3.6	1:55	0.086	19:25	0.215	0.150	0.150	0.00
3/20/2018	3:00	1.5	20:05	1.9	1.7	1:40	2.6	18:25	4.4	3.5	2:25	0.088	18:25	0.208	0.142	0.142	0.00
3/21/2018	3:00	1.5	18:35	2.0	1.7	0:05	2.8	18:50	4.4	3.5	3:40	0.098	18:50	0.215	0.144	0.144	0.10
3/22/2018	1:40	1.5	20:30	1.9	1.8	0:50	2.5	19:10	4.3	3.7	0:50	0.093	16:55	0.196	0.151	0.151	0.48
3/23/2018	4:25	1.6	9:45	1.9	1.8	3:20	2.5	18:20	4.5	3.8	3:20	0.096	18:00	0.208	0.165	0.165	0.31
3/24/2018	2:55	1.6	9:00	2.0	1.8	1:10	3.0	9:55	4.7	4.1	2:55	0.114	9:55	0.232	0.182	0.182	0.28
3/25/2018	4:20	1.6	9:15	1.9	1.8	23:55	3.2	9:15	4.8	4.2	4:20	0.124	9:15	0.226	0.180	0.180	0.01
3/26/2018	2:40	1.6	18:40	1.9	1.8	3:45	3.2	18:35	4.7	4.1	2:35	0.116	18:35	0.208	0.173	0.173	0.17
3/27/2018	3:50	1.6	16:50	1.8	1.8	3:15	3.2	16:40	4.7	4.1	3:15	0.118	16:50	0.204	0.169	0.169	0.02
3/28/2018	1:55	1.5	19:25	1.8	1.7	2:40	3.2	17:45	4.7	4.1	2:40	0.109	17:45	0.205	0.166	0.166	0.01
3/29/2018	3:00	1.5	18:30	1.8	1.7	1:00	3.1	19:50	4.6	4.0	3:00	0.101	18:30	0.202	0.160	0.160	0.00
3/30/2018	2:30	1.5	20:55	1.8	1.7	1:05	3.1	9:15	4.5	3.9	3:15	0.103	7:20	0.190	0.156	0.156	0.00
3/31/2018	2:05	1.5	9:50	1.9	1.7	0:25	2.9	9:45	4.8	4.0	2:25	0.101	9:45	0.221	0.161	0.161	0.00
ReportAvg	1.8					3.9					0.170						
ReportTotal																5.255	2.33

ADS Environmental Services

Pipe Height: 10.38

Date	REN_MH4628\mp1\DFINAL (inches)					REN_MH4628\mp1\VFINAL (feet/sec)					REN_MH4628\mp1\QFINAL (MGD - Total MG)					REN_RG\mp1\RAIN (inches)	
	Time	Min.	Time	Max.	Average	Time	Min.	Time	Max.	Average	Time	Min.	Time	Max.	Average	Total	Total
4/1/2018	2:15	1.5	9:30	1.9	1.7	3:25	2.8	9:05	4.7	4.0	2:20	0.097	9:30	0.214	0.162	0.162	0.10
4/2/2018	0:00	1.5	7:25	1.8	1.7	0:35	2.7	20:30	4.5	3.8	0:35	0.094	20:30	0.194	0.145	0.145	0.00
4/3/2018	22:40	1.6	20:20	1.8	1.7	3:10	2.6	21:10	4.6	3.7	2:45	0.094	21:10	0.199	0.141	0.141	0.00
4/4/2018	1:45	1.5	20:10	1.9	1.7	0:55	2.6	20:10	4.7	3.7	1:45	0.088	20:10	0.217	0.147	0.147	0.39
4/5/2018	0:25	1.6	18:55	1.9	1.7	3:00	2.6	18:55	4.6	3.9	3:00	0.096	18:55	0.208	0.155	0.155	0.25
4/6/2018	23:35	1.6	19:40	1.8	1.7	1:55	2.9	7:50	4.5	3.9	2:25	0.106	19:40	0.196	0.156	0.156	0.00
4/7/2018	3:30	1.6	9:40	2.0	1.8	1:40	2.9	9:45	5.0	4.4	1:40	0.107	9:40	0.257	0.196	0.196	0.88
4/8/2018	4:35	1.8	10:20	2.2	1.9	2:15	4.1	10:20	5.4	4.9	2:15	0.174	10:20	0.315	0.232	0.232	0.45
4/9/2018	23:55	1.8	19:35	1.9	1.9	0:50	4.4	18:35	5.2	4.8	23:55	0.194	20:20	0.245	0.218	0.218	0.00
4/10/2018	2:45	1.8	19:05	1.9	1.9	3:05	4.2	17:20	5.1	4.7	3:05	0.178	19:05	0.238	0.211	0.211	0.23
4/11/2018	2:30	1.8	20:50	1.9	1.8	2:55	4.2	9:05	5.1	4.7	2:55	0.177	20:50	0.235	0.208	0.208	0.31
4/12/2018	12:15	1.7	11:50	3.0	1.9	2:05	4.4	11:50	6.3	4.7	12:20	0.179	11:50	0.545	0.211	0.211	0.11
4/13/2018	3:30	1.8	20:50	1.9	1.9	2:15	4.2	20:50	5.2	4.8	2:15	0.176	20:50	0.242	0.212	0.212	0.51
4/14/2018	0:45	1.9	23:55	3.5	2.6	2:10	4.9	23:40	6.7	5.8	2:10	0.223	23:55	0.725	0.431	0.431	1.52
4/15/2018	23:55	2.7	2:10	3.6	3.3	23:00	6.1	1:30	6.7	6.5	23:40	0.467	1:35	0.759	0.644	0.644	0.21
4/16/2018	3:35	2.7	18:00	3.1	2.9	3:35	5.9	20:55	6.6	6.2	3:35	0.445	20:05	0.612	0.511	0.511	0.71
4/17/2018	23:50	2.4	0:05	2.9	2.7	23:50	5.8	5:30	6.4	6.1	23:50	0.366	5:40	0.534	0.470	0.470	0.01
4/18/2018	23:55	2.1	6:35	2.5	2.4	23:55	5.3	6:05	6.0	5.7	23:55	0.280	6:20	0.411	0.360	0.360	0.12
4/19/2018	23:55	1.9	6:55	2.4	2.1	23:40	5.1	6:05	5.7	5.4	23:55	0.232	6:55	0.355	0.288	0.288	0.00
4/20/2018	2:30	1.9	6:30	2.1	2.0	23:55	4.7	18:15	5.5	5.1	23:55	0.212	6:30	0.293	0.244	0.244	0.00
4/21/2018	5:00	1.9	9:05	2.0	1.9	2:00	4.5	9:05	5.4	4.9	2:00	0.203	9:05	0.273	0.227	0.227	0.05
4/22/2018	2:10	1.8	9:10	2.0	1.9	2:25	4.3	11:20	5.2	4.8	2:25	0.187	9:10	0.252	0.219	0.219	0.00
ReportAvg	2.0					4.9					0.263						
ReportTotal																5.788	5.85

REN_MH4646

Located At: 582 Bronson Way NE (see attached site report for details)
Monitoring Period: December 22, 2017 – April 22, 2018
Pipe Dimensions: 8"
Finalized Silt Level: 0 mm

Site Data Characteristics: This site is located in a sanitary sewer pipe. The scattergraph indicates site operated in free flow conditions. The site did not surcharge during the monitoring period. The dry weather data plots above the Froude =1 curve indicating supercritical flow.

Site Data Bias & Editing: The depth and velocity measurements recorded by the flow monitor were consistent with field confirmations conducted to date and supported the relative accuracy of the flow monitor at this location. The finalized depth data utilized the downward ultrasonic sensor.

Site Data Uptime: The data uptime achieved during the monitoring period is provided in the table below. Based upon the quality and consistency of the observed flow depth and velocity data, the Continuity equation was used to calculate the flow rate for the monitoring period.

Entity	Percentage Uptime	
	Raw	Final
Depth (in)	100%	100%
Velocity (f/s)	100%	100%
Quantity (mgd)	100%	100%

Site Data Summary: The average flow depth, velocity, and quantity data observed during the monitoring period along with observed minimum and maximum data, are provided in the following table. The minimum and maximum rates recorded in the tables are based on 5-minute data intervals.

Item	Depth (in)	Velocity (f/s)	Quantity (mgd)	% Full
Minimum	1.02	6.57	0.138	13%
Maximum	1.82	11.44	0.387	23%
Average	1.34	9.28	0.225	17%

RENTON

Flow Monitoring Site Report



Site Name

REN_MH4646

Site Address /Location: 582 Bronson Way NE

Monitor Series
TRITON+

Location Type
Temporary

Site Access Details: located in turn lane

Latitude: 47.491659°
Longitude: -122.190337°

Pipe Size (H x W)
8.00" x 7.75"

Pipe Shape
Circular

Manhole #

System Characteristics

MH4646

Residential

Access

Traffic

Drive

Medium

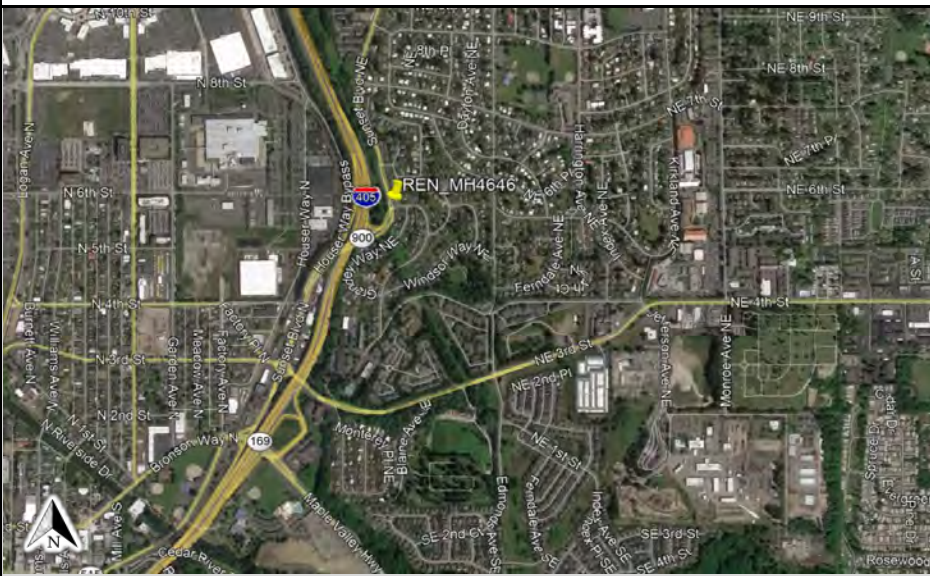

Installation Information

Installation Date: Wednesday, December 13, 2017	Installation Type: Doppler Standard Ring and Crank
Monitoring Location (Sensors): Downstream 0-5 FT	Monitor Location: Manhole
Sensors / Devices: Peak Combo (CS4), Smart Depth (CS5)	Pressure Sensor Range (psi) 0 - 5 psi

Installation Confirmation:

Confirmation Time: 12:28:00 PM	4 8.00" x 7.75"
Depth of Flow (Wet DOF) (in) 1.13	
CS5 Physical Offset (in)	Measurement Confidence (in) 0.25"
Peak Velocity (fps) 10.75	Velocity Sensor Offset (in) 0"
Silt (in) 0.00"	Silt Type

Hydraulic Comments:
low flow

Manhole / Pipe Information:

Manhole Depth (Approx. FT): 10	Manhole Configuration Sanitary Sewer Overflow
Manhole Material: Concrete	Manhole Condition: Good
Manhole Opening Diameter (in) 20"	Manhole Diameter (Approx.): 20"
Manhole Cover Steel	Manhole Frame Normal
Active Connections Yes, Inside	Air Quality: Normal
Pipe Material Vitrified Clay Pipe	Pipe Condition: Fair

Communication Information:

Communication Type Wireless	Antenna Location Manhole Pick / Vent Hole
--------------------------------	--

Additional Site Info. / Comments:

Renton traffic control Needed



ADS Project Name: Renton
ADS Project Number: 22275.11.325

Additional Photos

<p>Inlet</p> 	<p>Outlet</p> 	<p>Location Map</p> 
<p>Top Down</p> 	<p>Location</p> 	<p>Location Map</p> 
<p>Side inlet</p> 	<p>KEY</p> <p>→ Flow Direction</p> <p>⊖ Monitoring Point</p>	<p>Google Earth Map</p> 

HYDROGRAPH REPORT

REN_MH4646

Flow Monitor
REN_MH4646

Pipe Height
8.00 in

Report Period
12/22/2017
To
4/22/2018

Legend
— Depth
— Velocity
— Rain

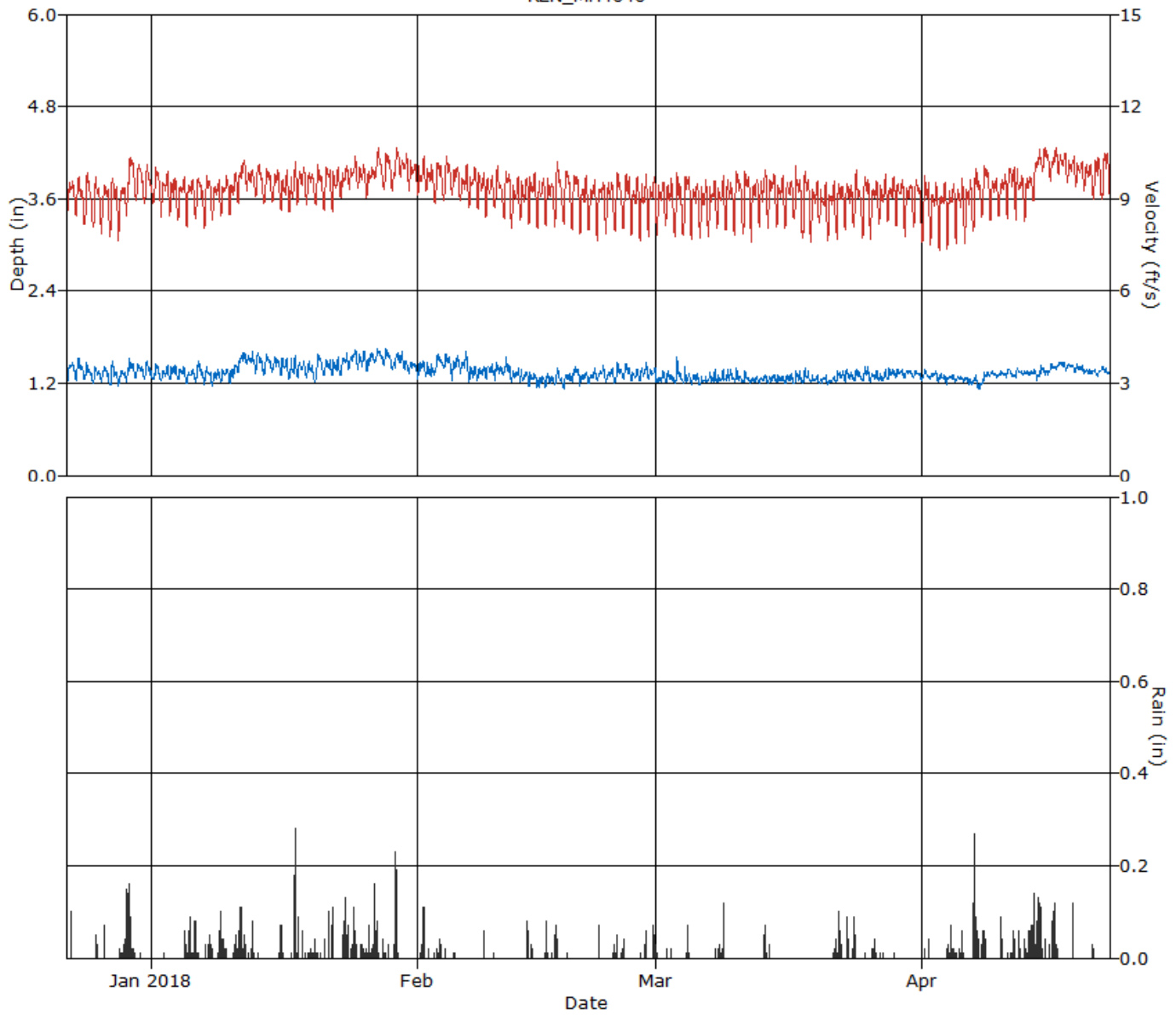

HYDROGRAPH REPORT

REN_MH4646

Flow Monitor
REN_MH4646

Pipe Height
8.00 in.

Report Period
12/22/2017
To
4/22/2018

Legend
— Quantity
— Rain

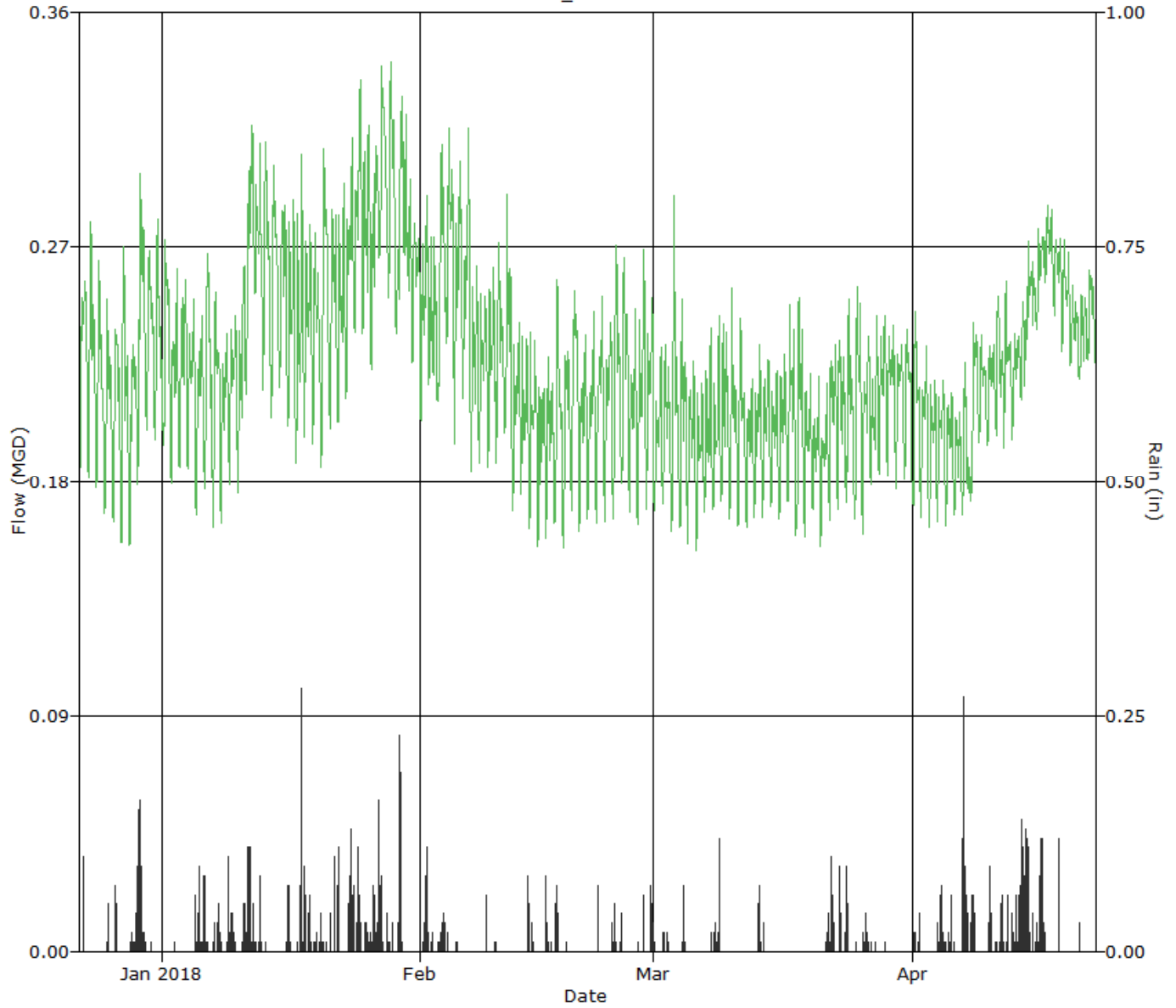

SCATTERGRAPH REPORT

REN_MH4646

Flow Monitor
REN_MH4646

Pipe Height
8.00 in

Report Period
12/22/2017
To
4/22/2018

Legend
○ Depth - Velocity
--- Iso-Q™
--- Silt
▼ Min-Max Depth

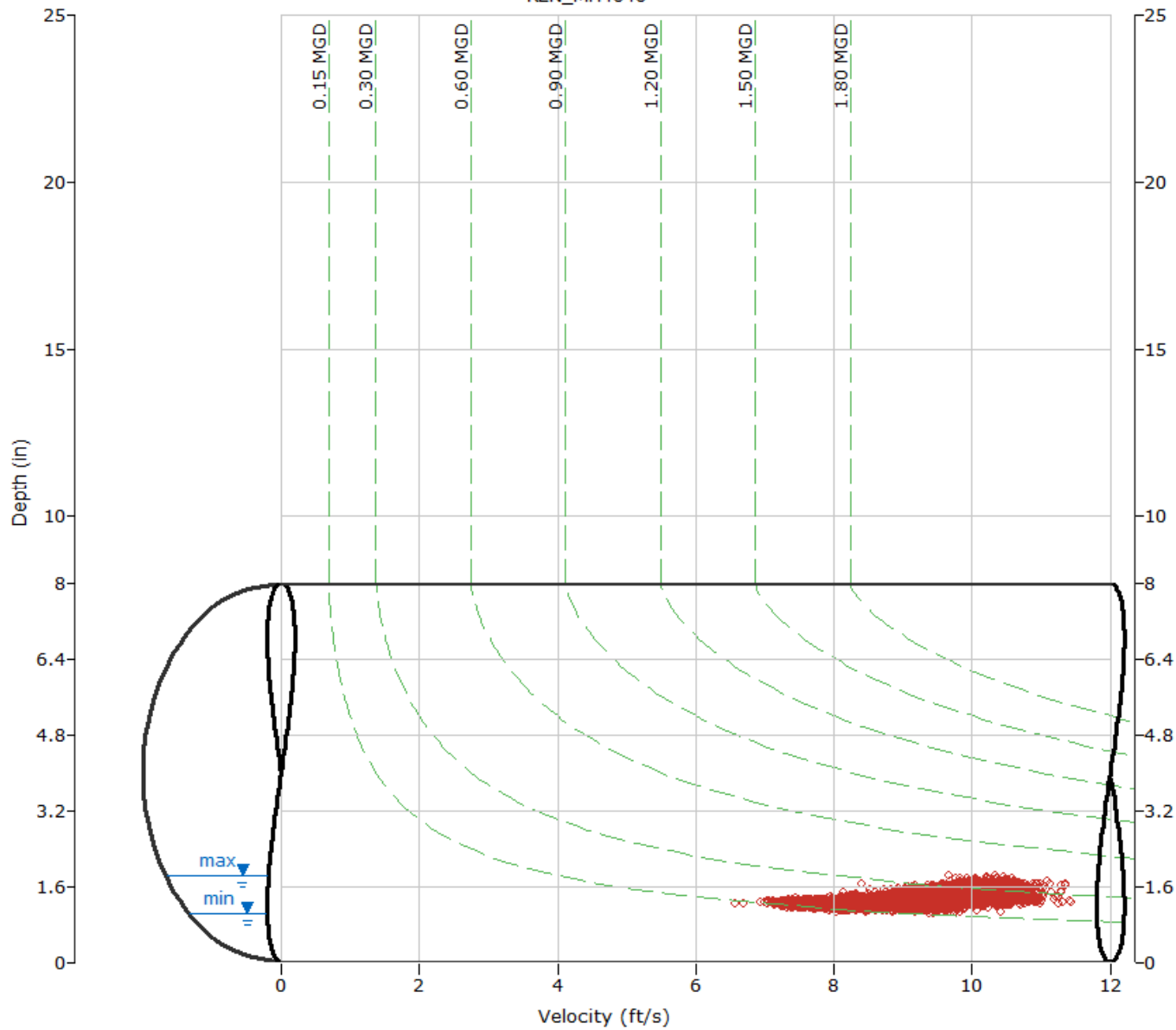

ADS Environmental Services

Pipe Height: 8.00

Date	REN_MH4646\mp1\DFINAL (inches)					REN_MH4646\mp1\VFINAL (feet/sec)					REN_MH4646\mp1\QFINAL (MGD - Total MG)						REN_RG\mp1\RAIN (inches)	
	Time	Min.	Time	Max.	Average	Time	Min.	Time	Max.	Average	Time	Min.	Time	Max.	Average	Total	Total	
12/22/2017	1:10	1.2	11:40	1.6	1.4	4:10	8.5	16:15	10.0	9.2	4:10	0.174	17:00	0.280	0.232	0.232	0.10	
12/23/2017	6:05	1.1	10:45	1.6	1.4	3:40	8.2	12:05	10.2	9.1	6:05	0.163	10:45	0.301	0.230	0.230	0.00	
12/24/2017	3:50	1.2	10:40	1.6	1.3	2:30	7.7	11:00	10.3	9.0	2:30	0.161	10:40	0.301	0.218	0.218	0.00	
12/25/2017	2:10	1.2	9:05	1.5	1.3	4:40	7.7	10:20	10.6	8.9	2:10	0.157	11:20	0.287	0.210	0.210	0.14	
12/26/2017	4:25	1.2	14:30	1.5	1.3	5:20	7.6	12:25	9.8	8.9	4:50	0.155	14:30	0.273	0.210	0.210	0.17	
12/27/2017	2:05	1.1	11:45	1.5	1.3	4:10	7.5	10:35	10.0	9.0	2:05	0.144	11:45	0.286	0.214	0.214	0.00	
12/28/2017	2:40	1.1	14:55	1.5	1.3	2:35	7.2	17:55	10.2	8.9	2:40	0.140	14:55	0.262	0.205	0.205	0.25	
12/29/2017	2:45	1.1	10:25	1.6	1.4	2:05	8.3	13:00	11.3	9.7	2:45	0.166	10:25	0.329	0.248	0.248	1.57	
12/30/2017	5:30	1.2	13:30	1.6	1.4	4:10	8.7	17:00	10.5	9.6	5:30	0.182	13:30	0.317	0.238	0.238	0.02	
12/31/2017	3:10	1.2	13:00	1.5	1.4	4:05	8.8	11:20	10.6	9.5	4:10	0.186	12:55	0.306	0.236	0.236	0.00	
ReportAvg	1.3					9.2					0.224							
ReportTotal																	2.241	2.25

ADS Environmental Services

Pipe Height: 8.00

Date	REN_MH4646\mp1\DFINAL (inches)					REN_MH4646\mp1\VFINAL (feet/sec)					REN_MH4646\mp1\QFINAL (MGD - Total MG)					REN_RG\mp1\RAIN (inches)	
	Time	Min.	Time	Max.	Average	Time	Min.	Time	Max.	Average	Time	Min.	Time	Max.	Average	Total	Total
1/1/2018	21:20	1.2	11:05	1.5	1.3	6:15	8.7	10:45	11.3	9.5	7:50	0.184	10:45	0.308	0.229	0.229	0.00
1/2/2018	5:00	1.2	19:40	1.5	1.3	3:40	8.2	19:40	10.5	9.3	3:40	0.167	19:40	0.294	0.221	0.221	0.01
1/3/2018	4:25	1.2	18:00	1.5	1.3	3:50	8.3	16:30	10.3	9.2	23:45	0.171	19:45	0.285	0.225	0.225	0.00
1/4/2018	0:45	1.2	19:00	1.5	1.3	3:35	8.1	19:15	10.4	9.1	1:50	0.170	19:15	0.279	0.219	0.219	0.09
1/5/2018	1:40	1.2	19:55	1.5	1.3	3:35	7.8	13:00	10.2	9.1	3:35	0.157	19:55	0.270	0.210	0.210	0.42
1/6/2018	3:05	1.2	13:10	1.6	1.4	2:40	8.2	11:35	10.2	9.2	3:05	0.168	11:35	0.297	0.225	0.225	0.24
1/7/2018	2:50	1.1	10:25	1.5	1.3	3:55	7.9	23:10	10.4	9.1	2:55	0.157	9:15	0.270	0.214	0.214	0.38
1/8/2018	1:20	1.1	18:45	1.5	1.3	2:35	8.1	9:35	9.9	9.1	3:45	0.157	18:45	0.268	0.206	0.206	0.14
1/9/2018	1:50	1.2	9:40	1.5	1.3	3:10	8.2	17:15	10.1	9.2	3:10	0.169	22:20	0.274	0.219	0.219	0.46
1/10/2018	3:35	1.1	13:50	1.5	1.3	2:10	8.2	20:35	10.5	9.3	4:35	0.161	16:10	0.286	0.225	0.225	0.22
1/11/2018	3:20	1.3	11:10	1.7	1.5	1:45	8.6	16:40	10.7	9.7	1:40	0.204	20:15	0.346	0.276	0.276	1.04
1/12/2018	16:55	1.3	6:20	1.8	1.5	2:55	9.1	18:40	10.7	9.7	5:20	0.229	6:20	0.359	0.275	0.275	0.20
1/13/2018	2:45	1.3	9:05	1.7	1.5	4:10	8.9	9:55	10.6	9.6	2:45	0.203	9:00	0.326	0.266	0.266	0.02
1/14/2018	3:00	1.3	11:30	1.7	1.5	3:35	8.7	16:10	10.5	9.5	3:00	0.196	11:50	0.338	0.258	0.258	0.00
1/15/2018	5:00	1.3	18:35	1.6	1.5	23:55	8.6	18:05	10.7	9.5	23:55	0.199	18:35	0.339	0.257	0.257	0.04
1/16/2018	2:35	1.2	19:50	1.7	1.4	3:45	8.5	21:35	10.6	9.3	2:35	0.187	19:50	0.329	0.243	0.243	0.26
1/17/2018	0:50	1.2	18:30	1.6	1.4	3:05	8.4	20:15	10.6	9.3	3:15	0.180	18:40	0.329	0.236	0.236	0.79
1/18/2018	12:35	1.2	18:20	1.6	1.4	2:20	8.7	18:35	10.2	9.6	2:30	0.185	18:20	0.312	0.246	0.246	0.40
1/19/2018	13:45	1.2	9:45	1.6	1.4	2:50	8.6	12:00	10.5	9.5	3:10	0.188	9:45	0.298	0.237	0.237	0.10
1/20/2018	1:00	1.2	10:05	1.7	1.4	5:15	8.6	11:45	11.0	9.5	3:10	0.178	10:05	0.335	0.250	0.250	0.10
1/21/2018	4:10	1.2	14:50	1.7	1.4	3:00	8.4	13:35	10.5	9.4	4:10	0.176	14:50	0.361	0.246	0.246	0.16
1/22/2018	8:30	1.2	6:50	1.6	1.4	3:45	8.4	6:20	10.5	9.4	8:30	0.186	20:00	0.324	0.246	0.246	0.34
1/23/2018	0:10	1.2	19:00	1.6	1.5	2:35	8.9	19:10	10.4	9.6	0:10	0.190	19:10	0.332	0.261	0.261	0.79
1/24/2018	23:55	1.2	19:50	1.8	1.5	3:40	9.1	20:25	10.6	9.8	23:55	0.207	19:50	0.380	0.285	0.285	0.51
1/25/2018	2:50	1.2	20:00	1.7	1.5	4:10	9.2	20:20	10.7	9.8	2:50	0.195	19:45	0.351	0.279	0.279	0.14
1/26/2018	1:50	1.3	20:00	1.7	1.5	3:05	8.9	10:20	10.6	9.7	3:05	0.203	13:05	0.344	0.275	0.275	0.36
1/27/2018	18:20	1.4	9:30	1.8	1.6	2:20	9.4	12:50	11.3	10.1	3:40	0.248	9:30	0.379	0.300	0.300	0.61
1/28/2018	0:40	1.3	13:50	1.8	1.5	5:00	9.2	9:35	11.1	10.0	0:40	0.236	13:50	0.387	0.294	0.294	0.07
1/29/2018	11:05	1.3	19:50	1.7	1.5	3:00	9.0	21:40	11.4	10.0	5:15	0.210	16:50	0.369	0.280	0.280	0.90
1/30/2018	11:40	1.2	5:55	1.7	1.5	23:35	9.5	18:25	11.1	10.1	11:40	0.205	8:35	0.352	0.276	0.276	0.00
1/31/2018	17:20	1.2	7:10	1.7	1.4	3:25	9.1	12:50	10.6	9.8	23:45	0.189	7:10	0.345	0.259	0.259	0.00
ReportAvg	1.4					9.5					0.250						
ReportTotal																7.740	8.79

ADS Environmental Services

Pipe Height: 8.00

Date	REN_MH4646\mp1\DFINAL (inches)					REN_MH4646\mp1\VFINAL (feet/sec)					REN_MH4646\mp1\QFINAL (MGD - Total MG)						REN_RG\mp1\RAIN (inches)	
	Time	Min.	Time	Max.	Average	Time	Min.	Time	Max.	Average	Time	Min.	Time	Max.	Average	Total	Total	
2/1/2018	3:50	1.1	16:35	1.8	1.4	3:25	9.0	19:05	10.8	9.7	3:50	0.160	16:35	0.354	0.249	0.249	0.66	
2/2/2018	5:20	1.1	6:15	1.6	1.4	2:50	9.1	10:45	10.7	9.7	5:20	0.183	16:30	0.329	0.237	0.237	0.04	
2/3/2018	2:20	1.2	13:15	1.8	1.5	3:45	8.7	14:45	10.8	9.6	2:20	0.175	13:15	0.373	0.261	0.261	0.31	
2/4/2018	0:05	1.2	16:00	1.7	1.5	3:10	8.7	11:45	10.8	9.7	0:05	0.190	9:55	0.338	0.270	0.270	0.02	
2/5/2018	2:25	1.1	16:40	1.7	1.4	1:55	8.9	19:00	10.4	9.7	2:25	0.168	16:40	0.343	0.260	0.260	0.04	
2/6/2018	3:45	1.1	17:55	1.7	1.5	2:55	8.7	10:15	10.4	9.5	3:45	0.174	17:55	0.338	0.259	0.259	0.00	
2/7/2018	12:40	1.1	19:25	1.5	1.3	2:15	8.5	19:35	10.3	9.5	2:10	0.165	6:25	0.286	0.228	0.228	0.00	
2/8/2018	0:05	1.1	6:20	1.6	1.3	3:10	8.5	20:25	10.7	9.4	2:25	0.178	6:20	0.302	0.226	0.226	0.09	
2/9/2018	0:55	1.1	8:40	1.6	1.4	3:10	8.3	16:25	10.3	9.2	1:00	0.159	8:40	0.305	0.227	0.227	0.01	
2/10/2018	3:10	1.2	13:50	1.6	1.4	1:55	8.6	12:50	10.7	9.3	3:10	0.172	10:35	0.306	0.234	0.234	0.01	
2/11/2018	23:50	1.1	10:30	1.6	1.4	5:15	8.2	11:45	10.6	9.3	23:50	0.169	11:55	0.321	0.234	0.234	0.00	
2/12/2018	0:25	1.1	22:10	1.6	1.3	3:10	7.7	19:20	10.0	9.0	3:35	0.153	22:10	0.305	0.211	0.211	0.00	
2/13/2018	3:40	1.1	21:30	1.5	1.3	2:20	8.2	20:05	10.1	9.1	3:40	0.153	21:30	0.276	0.209	0.209	0.17	
2/14/2018	23:40	1.1	22:30	1.6	1.3	3:15	7.9	19:00	10.5	9.2	2:55	0.152	22:30	0.291	0.203	0.203	0.15	
2/15/2018	9:05	1.1	8:00	1.5	1.2	2:50	7.8	18:10	9.9	9.1	4:05	0.144	8:00	0.266	0.194	0.194	0.00	
2/16/2018	22:00	1.1	9:15	1.5	1.2	2:45	7.8	20:45	10.5	9.1	1:10	0.145	9:15	0.277	0.198	0.198	0.15	
2/17/2018	18:30	1.1	23:10	1.5	1.3	3:55	7.9	10:55	11.1	9.3	2:55	0.150	10:55	0.320	0.208	0.208	0.32	
2/18/2018	5:15	1.1	21:25	1.5	1.2	4:35	7.9	14:20	10.9	9.3	5:15	0.138	14:25	0.291	0.202	0.202	0.01	
2/19/2018	23:35	1.1	21:20	1.6	1.3	3:45	7.9	12:15	10.3	9.1	4:45	0.153	21:20	0.305	0.219	0.219	0.00	
2/20/2018	0:25	1.1	20:20	1.4	1.3	2:20	7.7	20:50	10.3	9.0	0:30	0.153	20:30	0.249	0.201	0.201	0.00	
2/21/2018	1:15	1.1	0:00	1.6	1.3	4:10	7.6	13:30	10.2	9.0	1:15	0.144	0:00	0.280	0.206	0.206	0.00	
2/22/2018	8:55	1.1	20:00	1.6	1.3	2:30	7.3	16:55	10.2	8.9	2:30	0.153	20:00	0.304	0.211	0.211	0.07	
2/23/2018	0:50	1.1	21:35	1.5	1.3	3:10	7.6	9:05	10.3	9.0	3:55	0.147	21:35	0.269	0.210	0.210	0.01	
2/24/2018	3:55	1.1	14:25	1.6	1.3	4:05	7.5	9:55	10.3	9.0	3:50	0.140	14:25	0.303	0.217	0.217	0.13	
2/25/2018	7:30	1.2	10:40	1.6	1.4	3:20	7.6	10:25	10.0	9.1	3:20	0.156	10:40	0.299	0.223	0.223	0.11	
2/26/2018	2:15	1.2	19:25	1.5	1.3	3:50	7.5	19:30	10.6	8.9	2:15	0.160	18:35	0.269	0.206	0.206	0.00	
2/27/2018	2:20	1.2	20:30	1.6	1.3	2:20	7.3	21:40	10.0	8.9	2:20	0.144	20:30	0.309	0.216	0.216	0.19	
2/28/2018	3:15	1.2	0:00	1.6	1.3	2:10	7.3	19:55	10.1	9.0	3:50	0.155	21:35	0.281	0.216	0.216	0.35	
ReportAvg	1.3					9.2					0.223							
ReportTotal																	6.233 2.84	

ADS Environmental Services

Pipe Height: 8.00

Date	REN_MH4646\mp1\DFINAL (inches)					REN_MH4646\mp1\VFINAL (feet/sec)					REN_MH4646\mp1\QFINAL (MGD - Total MG)					REN_RG\mp1\RAIN (inches)	
	Time	Min.	Time	Max.	Average	Time	Min.	Time	Max.	Average	Time	Min.	Time	Max.	Average	Total	Total
3/1/2018	4:45	1.2	21:30	1.5	1.3	2:05	7.5	17:15	10.4	9.0	1:55	0.155	21:30	0.268	0.199	0.199	0.01
3/2/2018	3:25	1.2	9:05	1.5	1.3	2:55	7.8	18:45	10.3	9.0	2:50	0.156	9:05	0.262	0.204	0.204	0.07
3/3/2018	4:35	1.2	10:40	1.6	1.3	4:30	7.2	10:25	10.4	8.9	4:35	0.143	10:25	0.328	0.209	0.209	0.00
3/4/2018	12:20	1.1	9:25	1.7	1.3	5:50	7.4	15:35	10.8	9.0	5:50	0.143	9:30	0.318	0.200	0.200	0.12
3/5/2018	3:25	1.1	18:30	1.4	1.3	3:10	7.4	12:10	10.5	8.9	3:45	0.146	18:30	0.249	0.198	0.198	0.00
3/6/2018	0:55	1.1	6:40	1.4	1.2	3:30	7.3	18:30	10.6	8.9	3:30	0.142	7:10	0.247	0.189	0.189	0.00
3/7/2018	16:05	1.2	17:05	1.5	1.3	1:50	7.4	18:45	9.9	8.9	3:00	0.155	17:05	0.263	0.200	0.200	0.03
3/8/2018	3:35	1.2	20:55	1.6	1.3	3:30	7.6	20:45	10.4	9.0	3:35	0.150	20:55	0.304	0.200	0.200	0.37
3/9/2018	4:35	1.2	18:05	1.6	1.3	2:05	7.7	19:00	10.2	9.0	5:15	0.162	18:05	0.298	0.206	0.206	0.00
3/10/2018	15:45	1.2	10:20	1.5	1.3	4:25	7.1	10:40	10.7	9.1	4:25	0.156	10:20	0.274	0.204	0.204	0.00
3/11/2018	5:10	1.2	10:10	1.4	1.3	4:10	7.4	9:40	10.8	9.1	4:05	0.150	9:40	0.277	0.201	0.201	0.00
3/12/2018	0:10	1.2	20:30	1.4	1.2	2:00	7.0	17:20	10.8	9.0	2:00	0.148	20:30	0.256	0.195	0.195	0.00
3/13/2018	3:00	1.2	18:00	1.4	1.2	1:50	7.8	17:05	10.3	9.2	2:25	0.158	18:00	0.261	0.200	0.200	0.31
3/14/2018	0:20	1.2	20:25	1.5	1.3	2:05	7.7	9:10	10.6	9.2	1:05	0.154	20:25	0.265	0.202	0.202	0.04
3/15/2018	3:20	1.2	19:45	1.4	1.3	1:50	7.7	9:30	10.3	9.1	3:20	0.151	19:45	0.257	0.199	0.199	0.00
3/16/2018	0:50	1.2	6:00	1.5	1.3	2:55	7.5	9:50	10.2	9.1	1:35	0.154	6:00	0.262	0.202	0.202	0.00
3/17/2018	1:15	1.2	12:45	1.5	1.3	0:25	7.8	8:55	10.8	9.1	5:15	0.153	12:45	0.277	0.204	0.204	0.00
3/18/2018	1:20	1.2	9:30	1.6	1.3	4:35	7.1	11:20	10.2	9.0	4:35	0.149	9:30	0.310	0.202	0.202	0.00
3/19/2018	23:55	1.2	17:45	1.5	1.2	2:35	7.2	20:40	10.1	8.9	2:20	0.145	17:45	0.270	0.194	0.194	0.00
3/20/2018	1:25	1.2	20:15	1.5	1.2	23:45	7.8	7:45	10.2	8.9	23:50	0.151	20:15	0.255	0.192	0.192	0.00
3/21/2018	1:15	1.2	19:20	1.5	1.2	0:20	7.2	11:55	9.8	8.8	1:45	0.145	19:20	0.275	0.188	0.188	0.10
3/22/2018	0:45	1.2	4:35	1.5	1.3	2:05	7.4	12:25	9.9	8.9	3:10	0.151	19:15	0.280	0.206	0.206	0.48
3/23/2018	0:45	1.2	5:20	1.6	1.3	1:00	7.5	8:20	10.0	9.0	0:50	0.158	10:10	0.285	0.207	0.207	0.31
3/24/2018	2:45	1.2	11:40	1.6	1.3	2:40	7.7	11:20	10.1	9.0	1:05	0.163	11:40	0.288	0.208	0.208	0.28
3/25/2018	4:35	1.2	19:35	1.6	1.3	4:15	7.5	19:05	10.4	8.9	3:25	0.152	19:25	0.293	0.208	0.208	0.01
3/26/2018	0:25	1.2	17:30	1.6	1.3	1:10	7.3	8:40	10.3	9.0	2:40	0.152	20:35	0.286	0.205	0.205	0.17
3/27/2018	4:40	1.2	19:15	1.5	1.3	0:45	7.7	19:40	10.3	9.1	1:00	0.164	19:15	0.283	0.206	0.206	0.02
3/28/2018	1:15	1.2	4:40	1.5	1.3	2:00	8.0	19:50	10.2	9.1	1:15	0.164	18:55	0.262	0.216	0.216	0.01
3/29/2018	1:15	1.2	8:20	1.4	1.3	1:35	7.9	14:25	10.1	9.1	1:45	0.175	18:00	0.256	0.217	0.217	0.00
3/30/2018	0:00	1.2	7:40	1.4	1.3	2:00	7.4	17:55	9.7	9.0	2:40	0.164	7:40	0.248	0.214	0.214	0.00
3/31/2018	1:25	1.2	9:20	1.4	1.3	1:55	7.8	11:40	10.2	9.0	0:15	0.164	9:15	0.254	0.211	0.211	0.00
ReportAvg	1.3					9.0					0.203						
ReportTotal																6.289	2.33

ADS Environmental Services

Pipe Height: 8.00

Date	REN_MH4646\mp1\DFINAL (inches)					REN_MH4646\mp1\VFINAL (feet/sec)					REN_MH4646\mp1\QFINAL (MGD - Total MG)					REN_RG\mp1\RAIN (inches)	
	Time	Min.	Time	Max.	Average	Time	Min.	Time	Max.	Average	Time	Min.	Time	Max.	Average	Total	Total
4/1/2018	0:30	1.2	7:55	1.4	1.3	2:55	7.2	16:25	10.4	8.9	4:00	0.155	8:50	0.257	0.206	0.206	0.10
4/2/2018	23:50	1.1	17:15	1.4	1.3	2:30	7.1	17:20	10.5	8.7	23:50	0.154	17:20	0.261	0.201	0.201	0.00
4/3/2018	22:45	1.1	6:00	1.4	1.3	2:00	6.6	10:45	10.1	8.7	2:00	0.142	6:00	0.233	0.195	0.195	0.00
4/4/2018	22:45	1.2	19:40	1.4	1.3	1:30	6.9	18:05	9.7	8.8	0:10	0.154	17:20	0.232	0.196	0.196	0.39
4/5/2018	23:50	1.1	3:25	1.3	1.3	1:45	7.1	18:25	10.4	8.9	2:35	0.149	18:25	0.223	0.195	0.195	0.25
4/6/2018	13:15	1.1	2:50	1.3	1.2	1:50	7.3	8:25	10.1	8.9	23:45	0.153	6:20	0.225	0.189	0.189	0.00
4/7/2018	20:45	1.0	5:55	1.3	1.2	0:20	7.5	14:40	10.4	9.2	20:45	0.153	8:50	0.245	0.190	0.190	0.88
4/8/2018	1:15	1.0	9:20	1.4	1.3	2:30	8.2	13:00	10.9	9.4	1:15	0.141	16:30	0.259	0.213	0.213	0.45
4/9/2018	20:30	1.2	6:25	1.4	1.3	2:15	8.1	17:00	10.3	9.2	2:15	0.185	17:00	0.247	0.216	0.216	0.00
4/10/2018	23:35	1.2	8:05	1.4	1.3	2:40	8.2	12:30	10.0	9.2	2:45	0.181	8:05	0.264	0.217	0.217	0.23
4/11/2018	19:25	1.2	8:00	1.4	1.3	2:45	7.9	21:15	10.6	9.5	2:45	0.181	8:00	0.264	0.225	0.225	0.31
4/12/2018	0:35	1.2	4:55	1.5	1.3	1:50	8.1	13:25	10.3	9.4	1:50	0.179	7:00	0.273	0.227	0.227	0.11
4/13/2018	21:00	1.3	21:20	1.4	1.3	1:30	8.0	15:20	10.7	9.3	1:40	0.184	15:20	0.264	0.223	0.223	0.51
4/14/2018	11:50	1.1	22:45	1.5	1.3	1:55	8.7	17:15	11.4	9.9	0:40	0.185	22:25	0.302	0.235	0.235	1.52
4/15/2018	13:25	1.2	3:40	1.5	1.4	22:00	9.6	13:20	11.3	10.3	19:15	0.216	18:40	0.285	0.252	0.252	0.21
4/16/2018	0:30	1.2	20:05	1.5	1.4	1:55	9.5	14:30	11.4	10.2	0:30	0.203	20:05	0.309	0.264	0.264	0.71
4/17/2018	21:15	1.3	8:35	1.5	1.4	23:45	9.7	19:00	10.8	10.2	22:25	0.235	17:10	0.305	0.272	0.272	0.01
4/18/2018	21:35	1.3	4:30	1.5	1.4	2:40	9.3	19:30	10.6	10.0	1:05	0.220	7:35	0.292	0.261	0.261	0.12
4/19/2018	2:45	1.3	5:35	1.5	1.4	1:25	9.3	12:40	10.6	9.9	2:45	0.212	5:40	0.290	0.252	0.252	0.00
4/20/2018	23:25	1.2	23:30	1.4	1.4	2:05	9.0	23:25	11.0	9.8	3:00	0.208	7:50	0.271	0.240	0.240	0.00
4/21/2018	13:20	1.3	23:55	1.4	1.3	4:00	8.8	18:30	11.3	9.8	4:25	0.202	18:30	0.280	0.237	0.237	0.05
4/22/2018	11:05	1.2	7:40	1.5	1.4	2:40	8.8	16:45	11.0	9.9	1:20	0.207	7:40	0.277	0.244	0.244	0.00
ReportAvg	1.3					9.4					0.225						
ReportTotal																4.951	5.85

REN_MH5302

Located At: Royal Hills and SE Harrington Pl S (see attached site report for details)
Monitoring Period: December 22, 2017 – April 22, 2018
Pipe Dimensions: 19.88"
Finalized Silt Level: 0 mm

Site Data Characteristics: This site is located in a sanitary sewer pipe. The scattergraph indicates site operated in free flow conditions. The site did not surcharge during the monitoring period. The dry weather data plots below the Froude =1 curve indicating subcritical flow.

Site Data Bias & Editing: The depth and velocity measurements recorded by the flow monitor were consistent with field confirmations conducted to date and supported the relative accuracy of the flow monitor at this location. The finalized depth data utilized the upward ultrasonic sensor.

Site Data Uptime: The data uptime achieved during the monitoring period is provided in the table below. Based upon the quality and consistency of the observed flow depth and velocity data, the Continuity equation was used to calculate the flow rate for the monitoring period.

Entity	Percentage Uptime Raw	Percentage Uptime Final
Depth (in)	100%	100%
Velocity (f/s)	100%	100%
Quantity (mgd)	100%	100%

Site Data Summary: The average flow depth, velocity, and quantity data observed during the monitoring period along with observed minimum and maximum data, are provided in the following table. The minimum and maximum rates recorded in the tables are based on 5-minute data intervals.

Item	Depth (in)	Velocity (f/s)	Quantity (mgd)	% Full
Minimum	5.87	2.33	0.826	30%
Maximum	13.86	5.18	5.184	70%
Average	9.08	3.54	2.169	46%

Renton.Carollo.I&I.WA17

Flow Monitoring Site Report



Site Name

REN_MH5302

Site Address /Location:	Acces Via Royal Hills + SE Harrington Pl S		
Site Access Details:	Access via trail going under power lines, off main road.	Latitude:	47.471174°
		Longitude:	-122.180840°

Monitor Series	Location Type
TRITON+	Temporary
Pipe Size (H x W)	Pipe Shape
14.00" x 14.00"	Circular

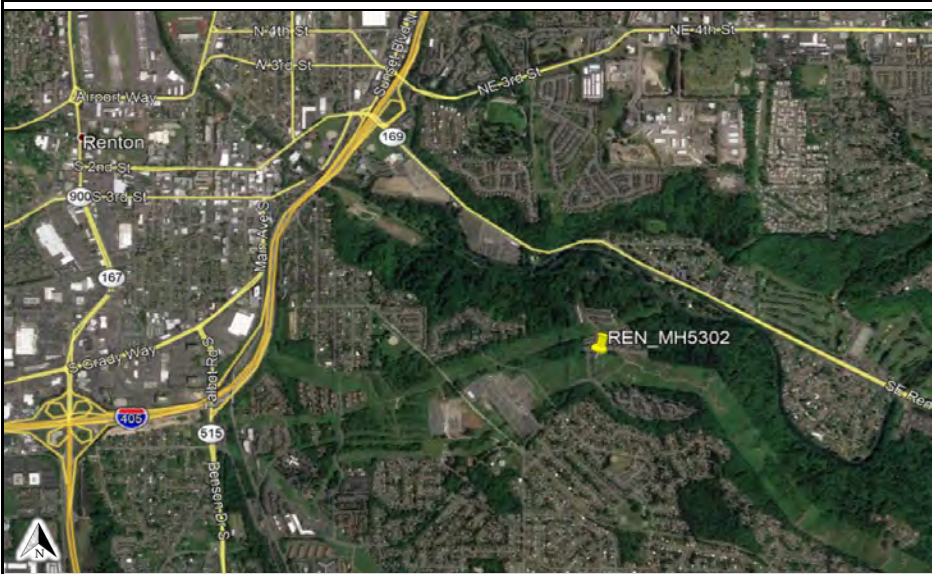

Manhole #	System Characteristics
MH3216	Other
Access	Traffic
Drive	Light



Installation Information	
Installation Date:	Installation Type:
12.20.17	Doppler Special Installation
Monitoring Location (Sensors):	Monitor Location:
Upstream 0-5 FT	Manhole
Sensors / Devices:	Pressure Sensor Range (psi)
Peak Combo (CS4)	0 - 5 psi

Installation Confirmation:	
Confirmation Time:	Pipe Size (HxW)
11:04:00 AM	14.00" x 14.00"
Depth of Flow (Wet DOF) (in)	Range (Air DOF) (in)
10.00"	
Downlooker Physical Offset (in)	Measurement Confidence (in)
-	0.25"
Peak Velocity (fps)	Velocity Sensor Offset (in)
~4.63 FPS	.50"
Silt (in)	Silt Type
0	

Hydraulic Comments:
Moderate, smooth flow



Manhole / Pipe Information:	
Manhole Depth (Approx. FT):	Manhole Configuration
~8'	Single
Manhole Material:	Manhole Condition:
Concrete	Good
Manhole Opening Diameter (in)	Manhole Diameter (Approx.):
20"	20"
Manhole Cover	Manhole Frame
Vented	Normal
Active Drop Connections	Air Quality:
No	Normal
Pipe Material	Pipe Condition:
PVC	Good

Communication Information:	
Communication Type	Antenna Location
Wireless	Manhole Pick / Vent Hole

Additional Site Info. / Comments:
Off trail. Confirmation information available from ADS.

ADS Project Name:	Renton.Carollo.I&I.WA17
ADS Project Number:	22275.11.325

Additional Photos

Upstream



Downstream



Side Inlet



Top Down



Location



Location



→ Flow Direction

⊗ Monitoring Point

HYDROGRAPH REPORT

REN_MH5302

Flow Monitor
REN_MH5302

Pipe Height
19.88 in

Report Period
12/22/2017
To
4/22/2018

Legend
— Depth
— Velocity
— Rain

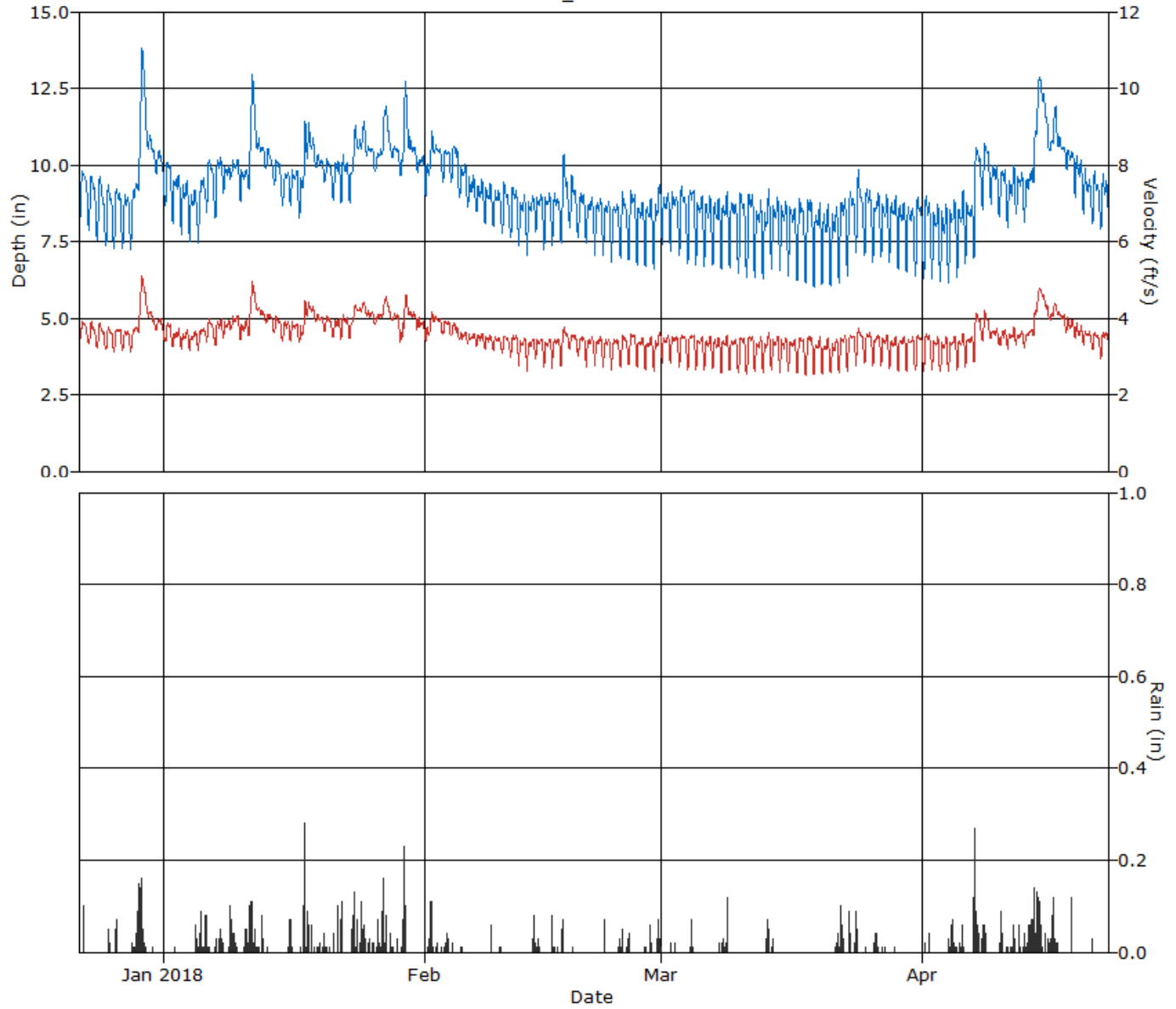

HYDROGRAPH REPORT

REN_MH5302

Flow Monitor
REN_MH5302

Pipe Height
19.88 in.

Report Period
12/22/2017
To
4/22/2018

Legend
— Quantity
— Rain

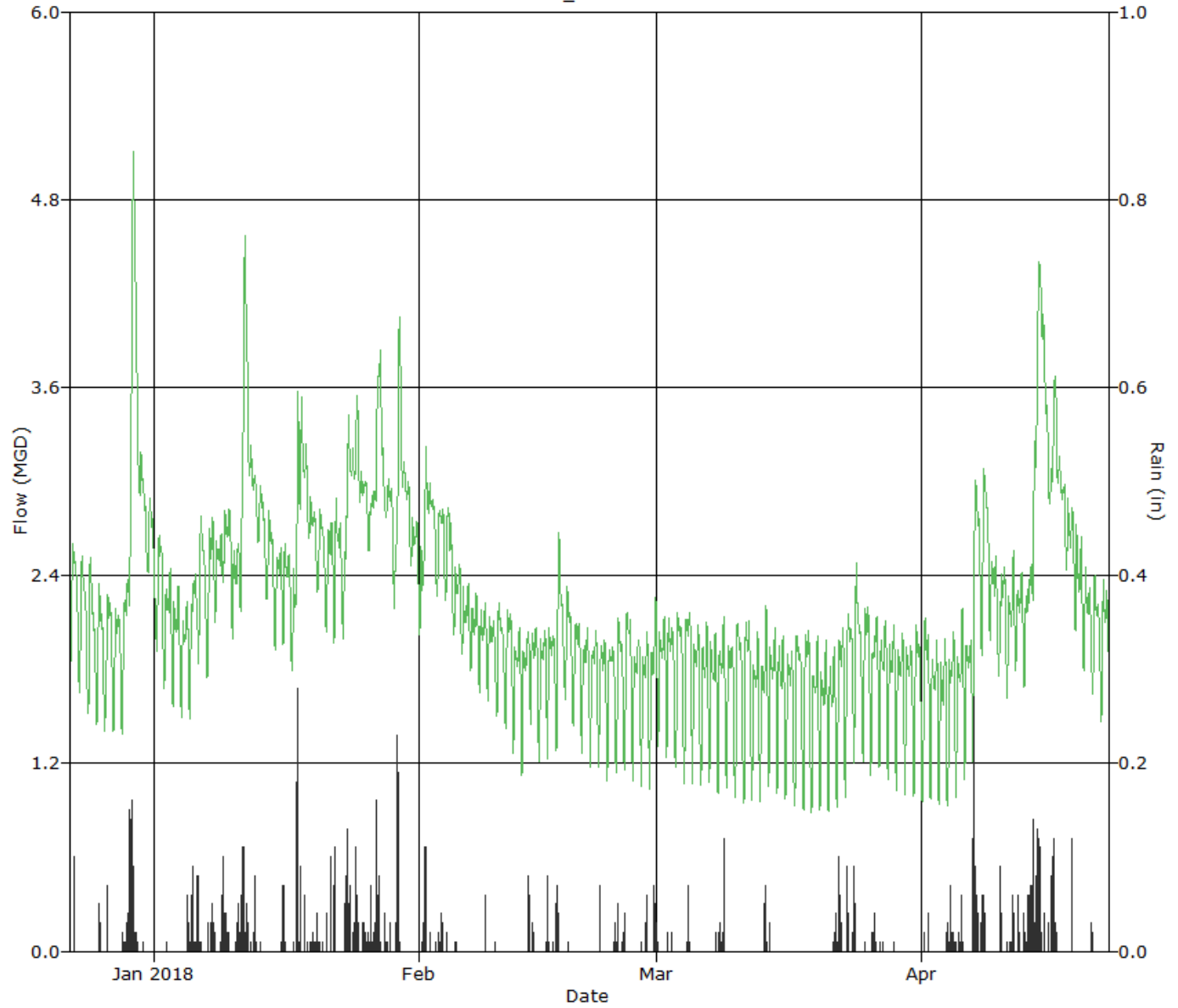

SCATTERGRAPH REPORT

REN_MH5302

Flow Monitor
REN_MH5302

Pipe Height
19.88 in

Report Period
12/22/2017
To
4/22/2018

Legend
○ Depth - Velocity
--- Iso-Q™
- - - Silt
▼ Min-Max Depth

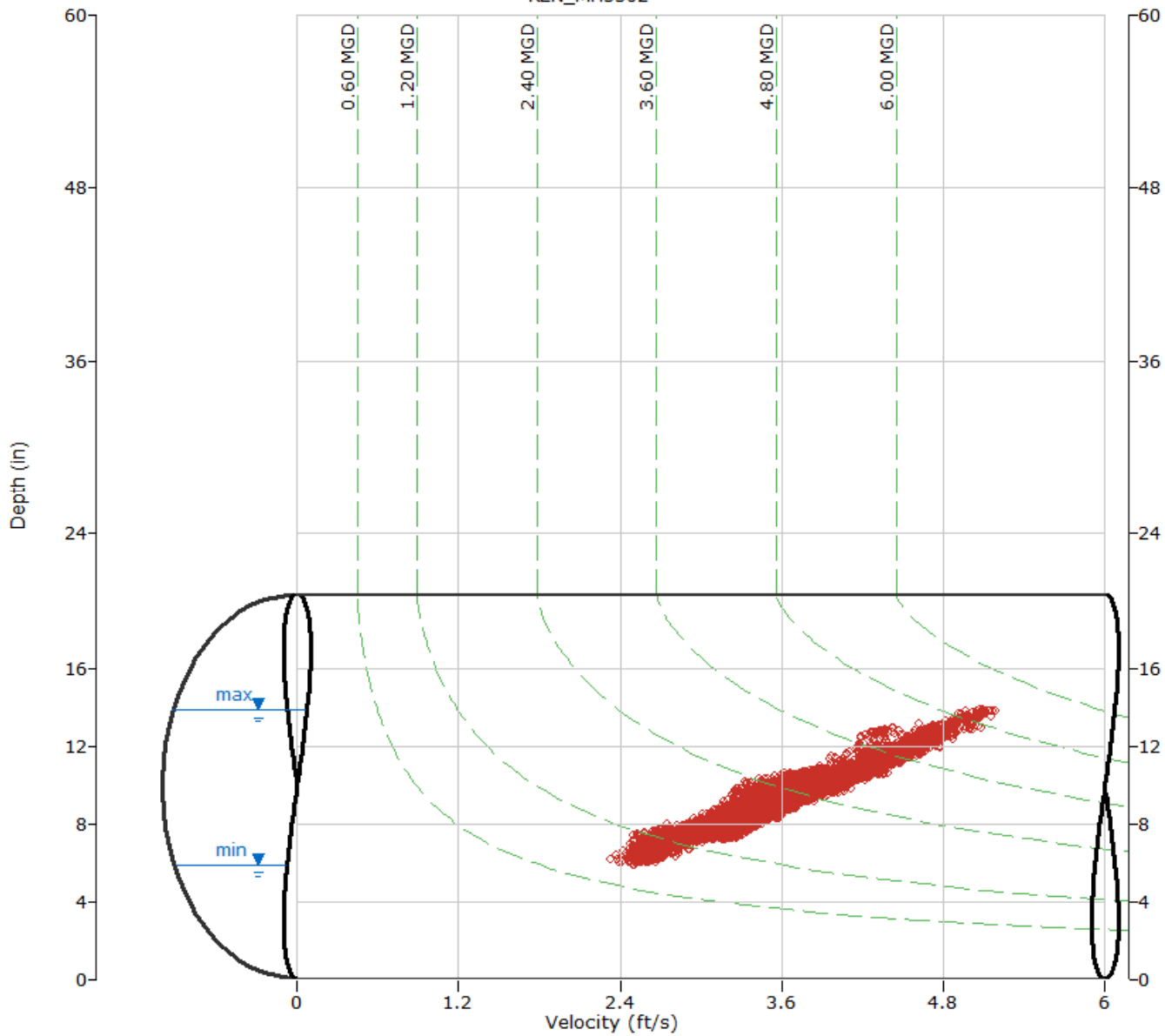

ADS Environmental Services

Pipe Height: 19.88

Date	REN_MH5302\mp1\DFINAL (inches)					REN_MH5302\mp1\VFINAL (feet/sec)					REN_MH5302\mp1\QFINAL (MGD - Total MG)					REN_RG\mp1\RAIN (inches)	
	Time	Min.	Time	Max.	Average	Time	Min.	Time	Max.	Average	Time	Min.	Time	Max.	Average	Total	Total
12/22/2017	3:50	8.2	9:25	9.9	9.3	2:55	3.4	9:25	4.1	3.7	4:40	1.804	9:25	2.735	2.301	2.301	0.10
12/23/2017	5:30	7.8	10:55	9.8	9.0	6:40	3.3	14:40	4.0	3.6	5:45	1.619	12:45	2.606	2.158	2.158	0.00
12/24/2017	4:45	7.4	11:25	9.8	8.7	3:50	3.1	11:15	4.1	3.6	4:40	1.460	11:25	2.669	2.050	2.050	0.00
12/25/2017	5:25	7.3	12:15	9.5	8.5	7:05	3.1	16:30	3.9	3.5	5:00	1.419	16:30	2.433	1.956	1.956	0.14
12/26/2017	4:30	7.3	11:55	9.4	8.5	4:10	3.1	11:50	3.9	3.5	4:15	1.383	11:50	2.447	1.948	1.948	0.17
12/27/2017	4:10	7.2	12:20	9.3	8.4	4:05	3.0	12:20	3.8	3.5	4:10	1.337	12:20	2.395	1.895	1.895	0.00
12/28/2017	4:20	7.2	23:55	9.6	8.6	6:30	3.0	19:35	4.0	3.5	4:15	1.323	19:35	2.550	2.004	2.004	0.25
12/29/2017	0:55	9.1	12:20	13.9	11.9	2:40	3.5	12:00	5.2	4.5	2:40	2.144	12:00	5.184	3.849	3.849	1.57
12/30/2017	23:55	10.2	0:35	11.4	10.7	21:10	3.6	0:35	4.5	4.1	21:10	2.613	0:35	3.577	3.022	3.022	0.02
12/31/2017	5:05	9.7	12:10	10.6	10.1	6:40	3.6	17:15	4.2	3.8	6:40	2.345	17:15	2.999	2.649	2.649	0.00
ReportAvg	9.4					3.7					2.383						
ReportTotal																23.83	2.25

ADS Environmental Services

Pipe Height: 19.88

Date	REN_MH5302\mp1\DFINAL (inches)					REN_MH5302\mp1\VFINAL (feet/sec)					REN_MH5302\mp1\QFINAL (MGD - Total MG)					REN_RG\mp1\RAIN (inches)	
	Time	Min.	Time	Max.	Average	Time	Min.	Time	Max.	Average	Time	Min.	Time	Max.	Average	Total	Total
1/1/2018	6:00	8.6	13:30	10.3	9.6	6:50	3.2	13:30	3.9	3.7	6:50	1.778	13:30	2.766	2.369	2.369	0.00
1/2/2018	4:35	8.1	20:55	9.8	9.2	3:10	3.1	12:15	3.9	3.5	3:10	1.641	20:55	2.588	2.136	2.136	0.01
1/3/2018	4:40	7.7	20:50	9.6	8.9	3:10	3.1	18:55	3.9	3.5	3:10	1.541	18:55	2.470	2.032	2.032	0.00
1/4/2018	4:10	7.4	18:40	9.5	8.6	3:30	3.1	21:40	3.9	3.5	3:30	1.446	21:40	2.430	1.954	1.954	0.09
1/5/2018	4:20	7.4	18:35	9.7	8.9	3:45	3.1	18:35	3.9	3.5	3:45	1.446	18:35	2.534	2.076	2.076	0.42
1/6/2018	4:10	8.4	10:35	10.3	9.5	4:25	3.3	12:00	4.1	3.7	4:25	1.776	12:00	2.894	2.393	2.393	0.24
1/7/2018	5:35	8.2	20:35	10.4	9.5	6:05	3.2	18:50	4.1	3.7	5:25	1.718	20:35	2.868	2.366	2.366	0.38
1/8/2018	4:20	9.0	19:55	10.2	9.7	3:05	3.4	21:45	4.0	3.8	4:20	2.035	19:55	2.777	2.475	2.475	0.14
1/9/2018	0:25	9.5	19:10	10.5	9.9	0:25	3.6	20:50	4.2	3.9	0:25	2.309	20:50	2.970	2.648	2.648	0.46
1/10/2018	3:55	8.8	21:25	10.0	9.6	5:00	3.3	12:25	4.0	3.7	3:20	1.933	21:25	2.694	2.395	2.395	0.22
1/11/2018	4:25	9.1	15:20	13.2	11.1	2:15	3.4	14:40	5.1	4.3	2:15	2.102	14:50	4.733	3.401	3.401	1.04
1/12/2018	23:55	10.3	0:00	11.1	10.6	14:55	4.0	0:10	4.4	4.2	14:55	2.853	0:00	3.427	3.059	3.059	0.20
1/13/2018	4:20	9.9	10:20	10.8	10.2	4:20	3.8	11:55	4.3	4.0	4:20	2.560	10:20	3.144	2.781	2.781	0.02
1/14/2018	4:35	9.3	10:30	10.4	9.8	3:55	3.4	10:25	4.2	3.8	3:55	2.151	10:25	3.005	2.542	2.542	0.00
1/15/2018	4:45	8.6	19:00	10.0	9.4	3:55	3.4	20:30	4.0	3.7	3:55	1.901	20:30	2.681	2.335	2.335	0.04
1/16/2018	4:30	8.6	9:05	10.0	9.4	3:15	3.3	6:50	4.1	3.7	3:15	1.892	6:50	2.736	2.344	2.344	0.26
1/17/2018	4:45	8.2	20:00	11.6	9.6	3:35	3.3	20:05	4.6	3.8	4:20	1.760	20:05	3.669	2.447	2.447	0.79
1/18/2018	2:50	10.1	7:25	11.6	10.7	23:15	3.9	7:10	4.5	4.2	2:50	2.755	7:25	3.635	3.120	3.120	0.40
1/19/2018	23:20	9.8	8:40	10.5	10.1	23:15	3.8	6:45	4.2	4.0	23:15	2.528	8:40	3.009	2.747	2.747	0.10
1/20/2018	3:45	9.4	10:20	10.4	9.9	3:10	3.6	11:55	4.1	3.9	3:10	2.265	11:55	2.941	2.593	2.593	0.10
1/21/2018	5:10	8.8	17:15	10.3	9.7	4:35	3.4	10:40	4.1	3.8	4:35	1.996	17:15	2.857	2.466	2.466	0.16
1/22/2018	4:05	8.7	7:30	10.4	9.7	2:10	3.3	7:10	4.2	3.8	2:10	1.891	7:10	2.962	2.511	2.511	0.34
1/23/2018	4:25	8.7	19:35	11.4	10.0	3:30	3.4	19:55	4.5	3.9	3:30	1.937	19:55	3.515	2.699	2.699	0.79
1/24/2018	3:55	10.4	19:45	11.7	10.8	13:15	3.9	19:50	4.5	4.3	13:15	2.862	19:50	3.744	3.198	3.198	0.51
1/25/2018	23:55	10.2	7:40	10.8	10.5	10:55	3.8	7:40	4.3	4.1	10:55	2.738	7:40	3.229	2.959	2.959	0.14
1/26/2018	3:15	9.8	18:25	10.7	10.2	2:25	3.8	22:50	4.3	4.0	2:25	2.516	22:50	3.111	2.800	2.800	0.36
1/27/2018	0:15	10.3	7:55	12.2	11.2	23:25	3.9	11:00	4.7	4.3	0:15	2.843	11:05	4.073	3.388	3.388	0.61
1/28/2018	23:50	10.1	17:15	10.7	10.4	23:45	3.7	11:20	4.3	4.0	23:50	2.515	11:20	3.157	2.872	2.872	0.07
1/29/2018	4:15	9.6	16:55	13.0	10.9	3:40	3.2	20:20	4.7	3.9	3:40	2.096	20:20	4.253	2.997	2.997	0.90
1/30/2018	23:55	10.1	0:20	11.3	10.6	20:40	3.9	0:20	4.4	4.1	23:50	2.715	0:20	3.463	2.992	2.992	0.00
1/31/2018	23:55	9.7	19:40	10.4	10.1	23:10	3.5	8:05	4.1	3.8	23:10	2.342	8:05	2.890	2.627	2.627	0.00
ReportAvg	9.9					3.9					2.636						
ReportTotal																81.72	8.79

ADS Environmental Services

Pipe Height: 19.88

Date	REN_MH5302\mp1\DFINAL (inches)					REN_MH5302\mp1\VFINAL (feet/sec)					REN_MH5302\mp1\QFINAL (MGD - Total MG)					REN_RG\mp1\RAIN (inches)	
	Time	Min.	Time	Max.	Average	Time	Min.	Time	Max.	Average	Time	Min.	Time	Max.	Average	Total	Total
2/1/2018	3:20	8.9	22:25	11.3	9.9	3:25	3.3	22:30	4.2	3.7	3:20	1.957	22:25	3.346	2.519	2.519	0.66
2/2/2018	23:55	10.1	8:15	10.8	10.5	22:25	3.7	13:35	4.2	3.9	23:50	2.580	13:35	3.114	2.844	2.844	0.04
2/3/2018	4:50	9.4	21:30	10.6	10.1	5:50	3.5	18:10	4.1	3.8	5:50	2.208	18:10	2.978	2.632	2.632	0.31
2/4/2018	5:15	9.4	11:45	10.8	10.2	17:15	3.4	11:35	4.0	3.7	5:15	2.206	11:50	2.944	2.568	2.568	0.02
2/5/2018	4:30	8.9	8:05	10.5	9.6	1:35	3.3	8:00	3.8	3.5	4:00	1.995	8:00	2.773	2.290	2.290	0.04
2/6/2018	4:15	8.6	20:40	10.2	9.2	3:25	3.2	20:40	3.7	3.5	3:25	1.836	20:40	2.586	2.132	2.132	0.00
2/7/2018	4:25	8.4	7:55	10.1	9.0	2:45	3.0	19:50	3.7	3.5	2:45	1.669	19:50	2.500	2.058	2.058	0.00
2/8/2018	4:10	8.1	21:05	9.8	8.9	4:40	3.1	21:05	3.6	3.4	4:35	1.614	21:05	2.412	1.999	1.999	0.09
2/9/2018	4:25	7.9	9:20	9.6	8.8	4:15	3.0	8:55	3.6	3.4	4:15	1.542	9:25	2.292	1.945	1.945	0.01
2/10/2018	5:30	7.7	10:40	10.1	8.7	7:05	2.9	10:45	3.6	3.4	7:05	1.468	10:45	2.462	1.923	1.923	0.01
2/11/2018	6:10	7.6	12:20	9.7	8.7	5:25	2.8	15:45	3.6	3.4	5:25	1.351	12:25	2.349	1.902	1.902	0.00
2/12/2018	3:55	7.2	20:05	9.4	8.4	5:10	2.5	20:05	3.5	3.3	4:00	1.155	20:05	2.233	1.788	1.788	0.00
2/13/2018	4:10	7.0	18:55	9.3	8.4	3:30	2.5	18:55	3.5	3.2	3:30	1.079	18:55	2.183	1.756	1.756	0.17
2/14/2018	4:15	7.8	20:10	9.4	8.6	4:10	2.8	10:30	3.6	3.3	4:10	1.360	20:10	2.249	1.870	1.870	0.15
2/15/2018	4:25	7.2	19:05	9.3	8.5	3:50	2.6	22:20	3.5	3.2	4:00	1.192	22:25	2.150	1.793	1.793	0.00
2/16/2018	4:05	7.3	8:05	9.3	8.5	3:25	2.5	9:55	3.6	3.3	3:25	1.140	19:45	2.179	1.824	1.824	0.15
2/17/2018	4:45	7.3	10:35	10.5	9.0	4:25	2.5	12:10	3.9	3.4	4:25	1.140	12:10	2.788	2.052	2.052	0.32
2/18/2018	6:00	7.9	10:30	10.1	8.9	5:40	3.0	12:45	3.7	3.4	5:40	1.488	10:30	2.527	2.011	2.011	0.01
2/19/2018	4:05	7.6	12:45	10.1	8.6	4:15	2.9	12:45	3.7	3.3	4:15	1.379	12:45	2.526	1.872	1.872	0.00
2/20/2018	4:05	7.3	19:05	9.3	8.4	3:10	2.7	20:35	3.6	3.3	4:05	1.204	19:05	2.145	1.796	1.796	0.00
2/21/2018	4:15	6.9	18:40	9.1	8.3	2:50	2.7	20:10	3.6	3.3	3:50	1.131	22:20	2.150	1.769	1.769	0.00
2/22/2018	4:25	6.9	20:25	9.1	8.3	4:20	2.6	20:25	3.6	3.2	4:20	1.095	20:25	2.169	1.734	1.734	0.07
2/23/2018	4:10	6.8	20:20	8.9	8.2	3:55	2.5	12:45	3.6	3.2	3:55	1.033	12:45	2.030	1.714	1.714	0.01
2/24/2018	5:45	6.9	10:20	9.6	8.3	7:20	2.6	12:00	3.6	3.2	5:45	1.111	10:25	2.340	1.738	1.738	0.13
2/25/2018	5:15	6.8	10:30	9.7	8.3	5:20	2.6	13:00	3.7	3.3	5:20	1.083	13:00	2.365	1.802	1.802	0.11
2/26/2018	4:25	6.7	20:40	9.0	8.2	4:40	2.6	20:30	3.6	3.2	4:40	1.048	20:50	2.073	1.710	1.710	0.00
2/27/2018	3:40	6.6	20:55	9.3	8.2	4:20	2.5	20:55	3.6	3.2	4:20	0.997	20:55	2.223	1.693	1.693	0.19
2/28/2018	4:05	6.5	18:45	9.7	8.3	4:25	2.5	21:30	3.7	3.3	4:05	0.972	18:45	2.374	1.764	1.764	0.35
ReportAvg	8.8					3.4					1.982						
ReportTotal																55.50	2.84

ADS Environmental Services

Pipe Height: 19.88

Date	REN_MH5302\mp1\DFINAL (inches)					REN_MH5302\mp1\VFINAL (feet/sec)					REN_MH5302\mp1\QFINAL (MGD - Total MG)					REN_RG\mp1\RAIN (inches)	
	Time	Min.	Time	Max.	Average	Time	Min.	Time	Max.	Average	Time	Min.	Time	Max.	Average	Total	Total
3/1/2018	4:25	7.3	20:50	9.5	8.5	3:20	2.7	20:55	3.7	3.3	3:20	1.222	20:55	2.367	1.854	1.854	0.01
3/2/2018	3:45	7.1	8:20	9.6	8.5	4:30	2.7	9:55	3.6	3.3	3:30	1.209	8:20	2.301	1.859	1.859	0.07
3/3/2018	4:30	7.0	10:10	9.7	8.5	4:40	2.7	12:45	3.6	3.3	4:30	1.126	10:10	2.332	1.827	1.827	0.00
3/4/2018	5:30	6.7	21:25	9.8	8.4	5:35	2.6	21:30	3.7	3.3	5:35	1.042	21:25	2.424	1.806	1.806	0.12
3/5/2018	4:15	6.7	19:15	9.3	8.3	4:40	2.6	10:10	3.6	3.3	4:15	1.041	19:15	2.167	1.749	1.749	0.00
3/6/2018	4:05	6.6	20:40	9.2	8.2	4:20	2.5	20:35	3.6	3.2	4:20	0.970	20:40	2.216	1.718	1.718	0.00
3/7/2018	4:10	6.6	20:00	9.1	8.2	3:05	2.6	8:25	3.6	3.2	4:15	1.036	20:00	2.149	1.705	1.705	0.03
3/8/2018	4:05	6.5	20:45	9.6	8.2	3:05	2.5	20:45	3.6	3.2	4:05	0.972	20:45	2.340	1.716	1.716	0.37
3/9/2018	4:10	6.5	12:45	9.1	8.2	2:35	2.5	22:00	3.6	3.2	4:00	0.971	12:45	2.124	1.694	1.694	0.00
3/10/2018	5:20	6.4	10:25	9.4	8.1	5:05	2.4	11:50	3.6	3.2	5:05	0.931	11:50	2.262	1.683	1.683	0.00
3/11/2018	5:45	6.3	20:15	9.4	8.1	4:10	2.4	13:55	3.6	3.2	4:10	0.886	20:15	2.274	1.684	1.684	0.00
3/12/2018	3:25	6.2	20:05	9.1	8.0	3:05	2.5	20:05	3.6	3.2	3:05	0.900	20:05	2.143	1.628	1.628	0.00
3/13/2018	3:00	6.2	19:00	9.5	8.0	4:15	2.4	19:00	3.7	3.2	3:05	0.886	19:00	2.362	1.664	1.664	0.31
3/14/2018	3:10	6.6	20:00	9.2	8.2	4:05	2.6	17:50	3.6	3.3	3:00	1.023	20:00	2.177	1.717	1.717	0.04
3/15/2018	3:00	6.4	19:55	9.3	8.1	3:00	2.5	19:55	3.6	3.2	3:00	0.956	19:55	2.221	1.675	1.675	0.00
3/16/2018	2:40	6.3	8:15	8.9	8.0	3:10	2.5	20:50	3.5	3.2	3:10	0.936	8:15	2.022	1.632	1.632	0.00
3/17/2018	4:00	6.2	10:45	9.2	7.9	3:50	2.5	14:20	3.6	3.2	3:50	0.888	10:45	2.141	1.627	1.627	0.00
3/18/2018	4:20	6.2	19:20	9.2	7.9	5:00	2.3	12:10	3.6	3.2	5:00	0.833	19:20	2.180	1.629	1.629	0.00
3/19/2018	2:55	5.9	19:55	9.0	7.8	2:40	2.4	20:30	3.6	3.1	2:40	0.831	19:55	2.095	1.572	1.572	0.00
3/20/2018	3:35	6.0	19:00	8.9	7.8	3:35	2.4	20:35	3.6	3.1	3:35	0.826	19:00	2.093	1.543	1.543	0.00
3/21/2018	3:50	6.0	20:50	8.9	7.7	5:05	2.5	20:50	3.5	3.1	3:50	0.866	20:50	2.082	1.539	1.539	0.10
3/22/2018	3:40	6.1	19:50	9.1	8.1	4:50	2.5	13:20	3.7	3.2	3:10	0.899	21:45	2.190	1.688	1.688	0.48
3/23/2018	3:05	6.3	12:45	9.9	8.3	2:45	2.5	12:50	3.7	3.3	2:45	0.936	12:45	2.450	1.767	1.767	0.31
3/24/2018	3:10	7.0	9:30	10.1	8.6	3:25	2.6	9:20	3.9	3.4	3:00	1.132	9:20	2.669	1.916	1.916	0.28
3/25/2018	4:20	7.0	11:35	9.7	8.5	4:45	2.8	19:35	3.7	3.4	4:45	1.187	11:35	2.413	1.855	1.855	0.01
3/26/2018	3:05	6.7	18:05	9.6	8.3	2:50	2.6	18:05	3.7	3.3	2:50	1.044	18:05	2.357	1.796	1.796	0.17
3/27/2018	2:50	6.9	19:50	9.4	8.3	2:50	2.6	9:45	3.7	3.3	2:50	1.084	19:50	2.304	1.768	1.768	0.02
3/28/2018	3:15	6.7	19:20	9.2	8.3	2:55	2.6	7:30	3.6	3.2	3:20	1.030	19:10	2.161	1.732	1.732	0.01
3/29/2018	3:10	6.6	18:45	9.1	8.1	3:25	2.5	19:00	3.6	3.3	3:20	0.976	18:45	2.171	1.704	1.704	0.00
3/30/2018	3:20	6.5	19:30	9.1	8.0	3:15	2.5	7:40	3.6	3.3	3:15	0.955	19:30	2.148	1.676	1.676	0.00
3/31/2018	4:35	6.3	8:50	9.3	8.0	3:40	2.5	10:25	3.7	3.3	4:25	0.954	8:50	2.284	1.684	1.684	0.00
ReportAvg	8.2					3.2					1.713						
ReportTotal																53.11	2.33

ADS Environmental Services

Pipe Height: 19.88

Date	REN_MH5302\mp1\DFINAL (inches)					REN_MH5302\mp1\VFINAL (feet/sec)					REN_MH5302\mp1\QFINAL (MGD - Total MG)					REN_RG\mp1\RAIN (inches)	
	Time	Min.	Time	Max.	Average	Time	Min.	Time	Max.	Average	Time	Min.	Time	Max.	Average	Total	Total
4/1/2018	5:15	6.2	11:15	9.6	8.0	5:30	2.6	11:20	3.7	3.3	4:50	0.933	11:20	2.391	1.694	1.694	0.10
4/2/2018	3:35	6.2	19:45	8.9	7.8	3:15	2.6	19:55	3.6	3.2	3:40	0.938	19:45	2.107	1.611	1.611	0.00
4/3/2018	2:50	6.1	19:35	9.0	7.8	3:05	2.6	20:10	3.6	3.2	2:50	0.913	19:35	2.113	1.571	1.571	0.00
4/4/2018	3:35	6.1	21:15	9.1	7.9	3:25	2.4	21:20	3.6	3.2	3:25	0.850	21:15	2.163	1.632	1.632	0.39
4/5/2018	3:05	6.3	18:40	9.5	8.1	4:05	2.6	18:40	3.7	3.3	3:20	0.966	18:40	2.353	1.700	1.700	0.25
4/6/2018	3:15	6.7	7:45	9.2	8.2	3:10	2.7	20:15	3.6	3.3	3:10	1.067	7:45	2.177	1.743	1.743	0.00
4/7/2018	3:00	6.8	10:10	10.7	9.5	3:00	2.7	10:00	4.2	3.7	3:00	1.119	10:10	3.118	2.416	2.416	0.88
4/8/2018	3:40	8.5	11:45	10.9	9.9	3:05	3.3	9:50	4.3	3.8	3:40	1.850	11:50	3.196	2.595	2.595	0.45
4/9/2018	3:40	8.7	20:05	10.2	9.5	23:40	3.2	20:05	3.9	3.6	23:40	1.855	20:05	2.712	2.304	2.304	0.00
4/10/2018	3:20	8.2	20:15	10.1	9.3	7:35	3.2	18:20	3.9	3.5	3:25	1.719	18:25	2.660	2.169	2.169	0.23
4/11/2018	3:35	7.9	20:05	10.2	9.1	3:05	3.1	20:00	3.9	3.5	3:05	1.559	20:00	2.745	2.120	2.120	0.31
4/12/2018	3:10	8.3	18:20	10.2	9.2	2:45	3.2	20:20	3.8	3.5	2:45	1.740	18:20	2.610	2.162	2.162	0.11
4/13/2018	3:15	8.0	16:50	10.1	9.2	1:55	3.2	21:00	3.8	3.5	1:55	1.654	16:50	2.611	2.166	2.166	0.51
4/14/2018	3:35	9.4	19:50	13.0	11.2	4:40	3.4	21:30	4.9	4.2	4:40	2.173	19:50	4.537	3.334	3.334	1.52
4/15/2018	23:55	10.5	0:45	12.8	11.9	23:00	4.0	0:25	4.8	4.4	23:15	2.940	0:25	4.436	3.747	3.747	0.21
4/16/2018	1:45	10.4	19:35	12.1	11.1	4:45	3.8	17:25	4.5	4.2	4:45	2.765	15:55	3.836	3.215	3.215	0.71
4/17/2018	23:55	10.2	7:15	11.3	10.6	23:25	3.7	5:30	4.3	4.0	23:25	2.599	7:20	3.313	2.965	2.965	0.01
4/18/2018	23:55	9.5	6:25	10.6	10.2	23:45	3.5	6:25	4.2	3.8	23:45	2.199	6:25	3.061	2.661	2.661	0.12
4/19/2018	3:15	8.9	6:20	10.4	9.7	23:55	3.4	6:25	3.9	3.6	23:55	1.980	6:25	2.796	2.387	2.387	0.00
4/20/2018	3:15	8.3	9:10	10.1	9.2	3:30	3.1	19:35	4.0	3.5	3:30	1.700	19:35	2.713	2.156	2.156	0.00
4/21/2018	4:30	8.0	11:20	10.2	9.0	5:05	3.1	8:25	3.8	3.5	4:30	1.607	8:25	2.606	2.068	2.068	0.05
4/22/2018	3:50	7.9	9:10	10.0	8.9	5:05	2.9	10:40	3.7	3.4	5:05	1.430	10:40	2.544	2.008	2.008	0.00
ReportAvg	9.3					3.6					2.292						
ReportTotal																50.42	5.85

REN_MH5505

Located At: 4444 NE Sunset Blvd (see attached site report for details)
Monitoring Period: December 22, 2017 – April 22, 2018
Pipe Dimensions: 10"
Finalized Silt Level: 0 mm

Site Data Characteristics: This site is located in a sanitary sewer pipe. The scattergraph indicates site operated in free flow conditions. The site did not surcharge during the monitoring period. The dry weather data plots above the Froude =1 curve indicating supercritical flow.

Site Data Bias & Editing: The depth and velocity measurements recorded by the flow monitor were consistent with field confirmations conducted to date and supported the relative accuracy of the flow monitor at this location. The finalized depth data utilized the upward ultrasonic sensor.

Site Data Uptime: The data uptime achieved during the monitoring period is provided in the table below. Based upon the quality and consistency of the observed flow depth and velocity data, the Continuity equation was used to calculate the flow rate for the monitoring period.

Entity	Percentage Uptime Raw	Percentage Uptime Final
Depth (in)	100%	100%
Velocity (f/s)	100%	100%
Quantity (mgd)	100%	100%

Site Data Summary: The average flow depth, velocity, and quantity data observed during the monitoring period along with observed minimum and maximum data, are provided in the following table. The minimum and maximum rates recorded in the tables are based on 5-minute data intervals.

Item	Depth (in)	Velocity (f/s)	Quantity (mgd)	% Full
Minimum	1.29	4.30	0.132	13%
Maximum	5.86	8.11	0.954	59%
Average	1.83	6.45	0.293	18%

Renton.Carollo.I&I.WA17



Site Name

REN_MH5505

Flow Monitoring Site Report

Site Address /Location: 4444 NE Sunset Blvd

Monitor Series
TRITON+

Location Type
Temporary

Site Access Details: Site located between trees, park in lot

Latitude: 47.504955°
Longitude: -122.159403°

Pipe Size (H x W)
10.00" x 10.00"

Pipe Shape
Circular

Manhole #

MH5505

System Characteristics

Residential / Commercial

Access

Traffic

Drive

None

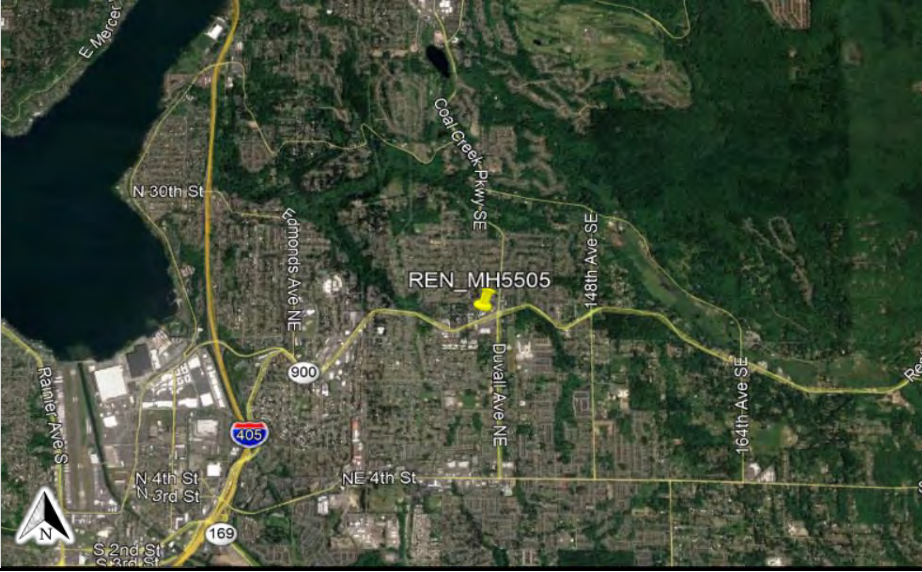

Installation Information

Installation Date: Wednesday, December 13, 2017	Installation Type: Doppler Standard Ring and Crank
Monitoring Location (Sensors): Downstream 0-5 FT	Monitor Location: Manhole
Sensors / Devices: Peak Combo (CS4), Smart Depth (CS5)	Pressure Sensor Range (psi) 0 - 5 psi

Installation Confirmation:

Confirmation Time: 11:50:00 AM	Pipe Size (HxW) 10.00" x 10.00"
Depth of Flow (Wet DOF) (in) 0.38"	
CS5 Physical Offset (in) 1.38"	Measurement Confidence (in) 0.25"
Peak Velocity (fps) 3.27'	Velocity Sensor Offset (in) 0"
Silt (in) 0.00"	Silt Type

Hydraulic Comments:

Straight, Some Ripples

Manhole / Pipe Information:

Manhole Depth (Approx. FT): 11'	Manhole Configuration Sanitary Sewer Overflow
Manhole Material: Brick	Manhole Condition: Good
Manhole Opening Diameter (in) 20"	Manhole Diameter (Approx.): 20"
Manhole Cover Steel	Manhole Frame Normal
Active Connections No	Air Quality: Normal
Pipe Material Vitrified Clay Pipe	Pipe Condition: Fair

Communication Information:

Communication Type Wireless	Antenna Location Manhole Pick / Vent Hole
--------------------------------	--

Additional Site Info. / Comments:

None.

ADS Project Name: Renton.Carollo.I&I.WA17

ADS Project Number: 22275.11.325

Additional Photos

Inlet



Outlet



Top Down



Location



Location Map



Utility Map

KEY

- Flow Direction
- ⊗ Monitoring Point

HYDROGRAPH REPORT

REN_MH5505

Flow Monitor
REN_MH5505

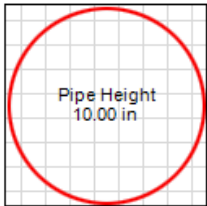

Report Period
12/22/2017
To
4/22/2018

Legend
— Depth
— Velocity

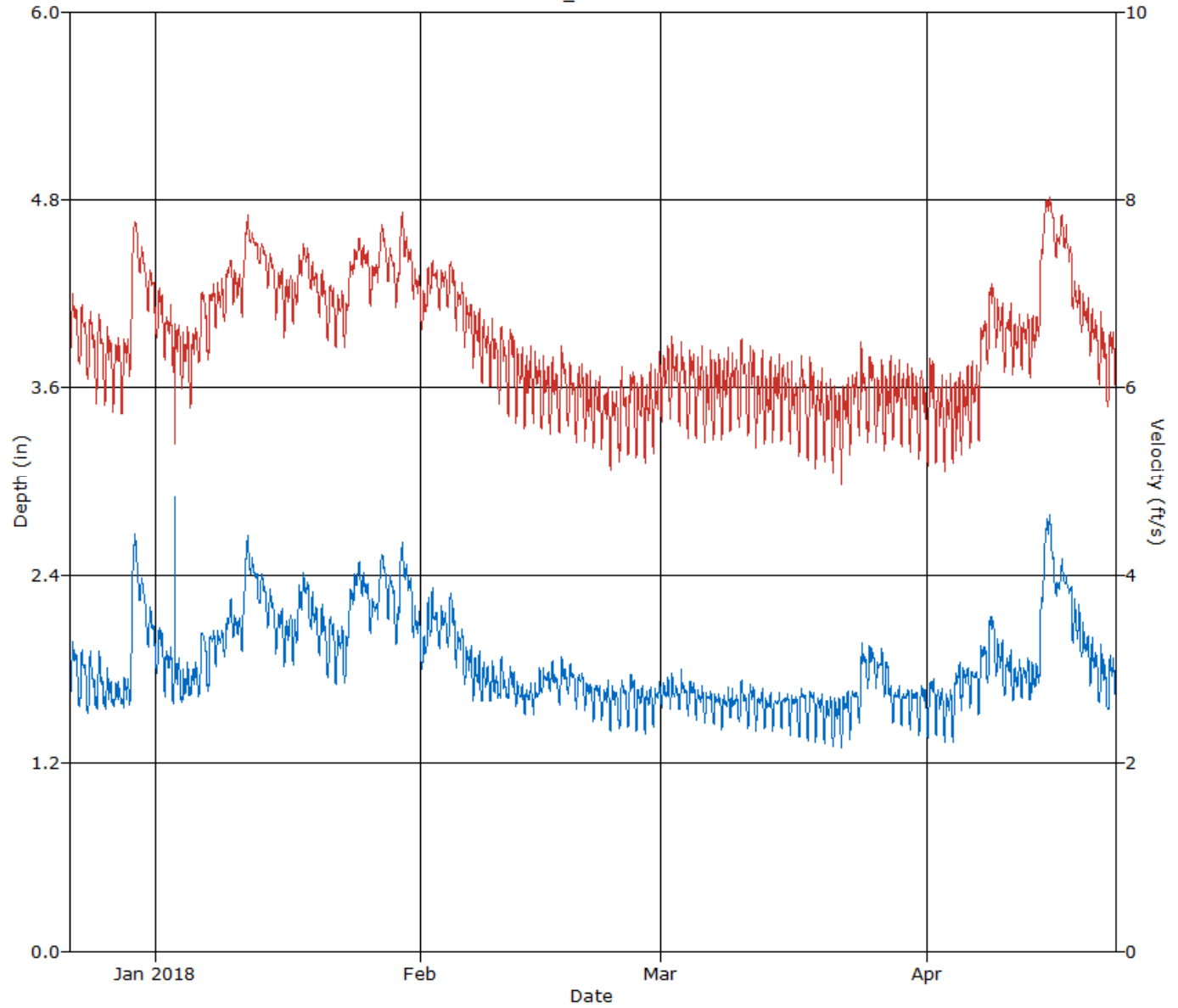

HYDROGRAPH REPORT

REN_MH5505

Flow Monitor
REN_MH5505

Pipe Height
10.00 in.

Report Period
12/22/2017
To
4/22/2018

Legend
Quantity

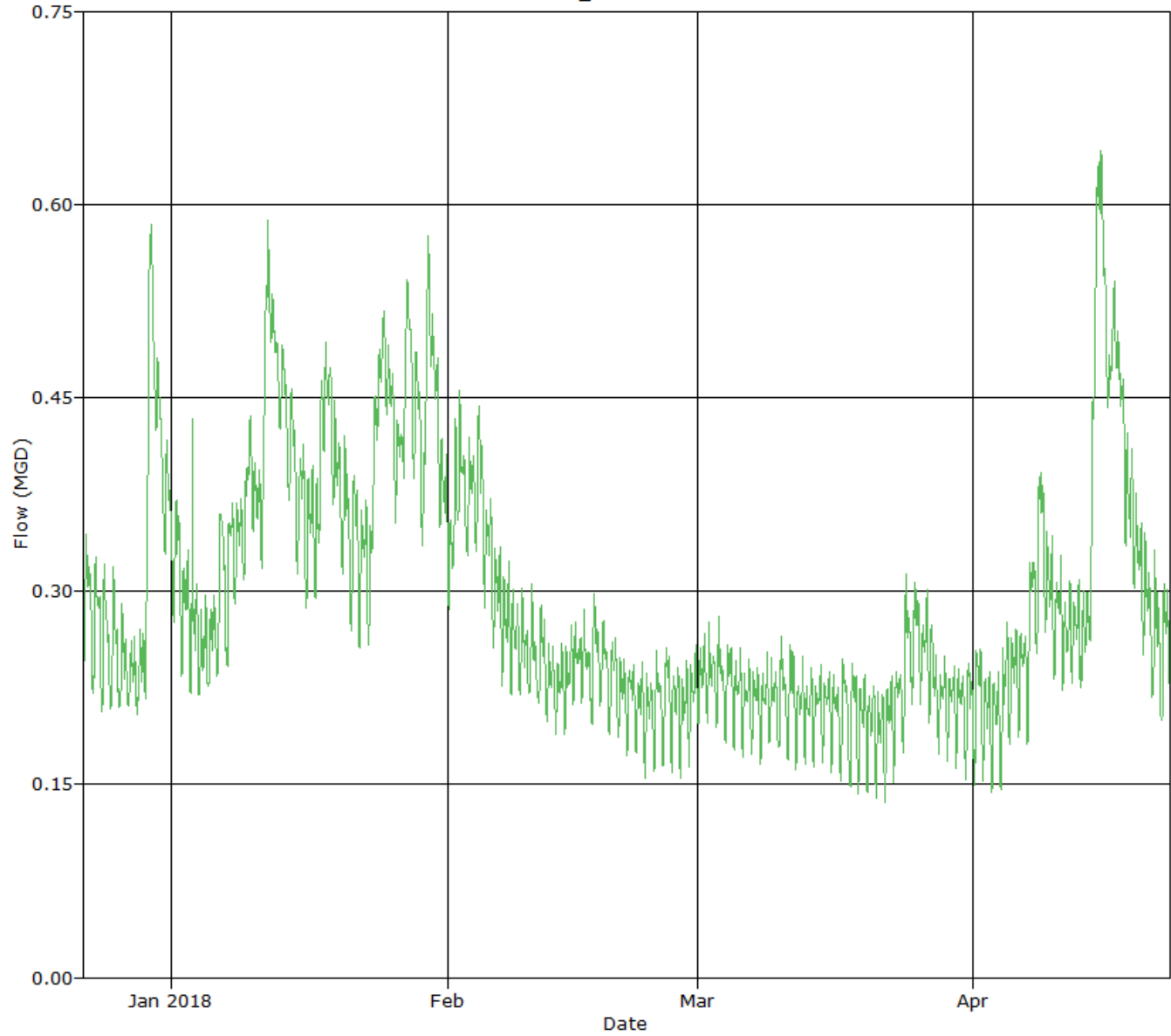

SCATTERGRAPH REPORT

REN_MH5505

Flow Monitor
REN_MH5505

Pipe Height
10.00 in

Report Period
12/22/2017
To
4/22/2018

Legend
○ Depth - Velocity
- - Iso-Q™
- - Silt
▼ Min-Max Depth

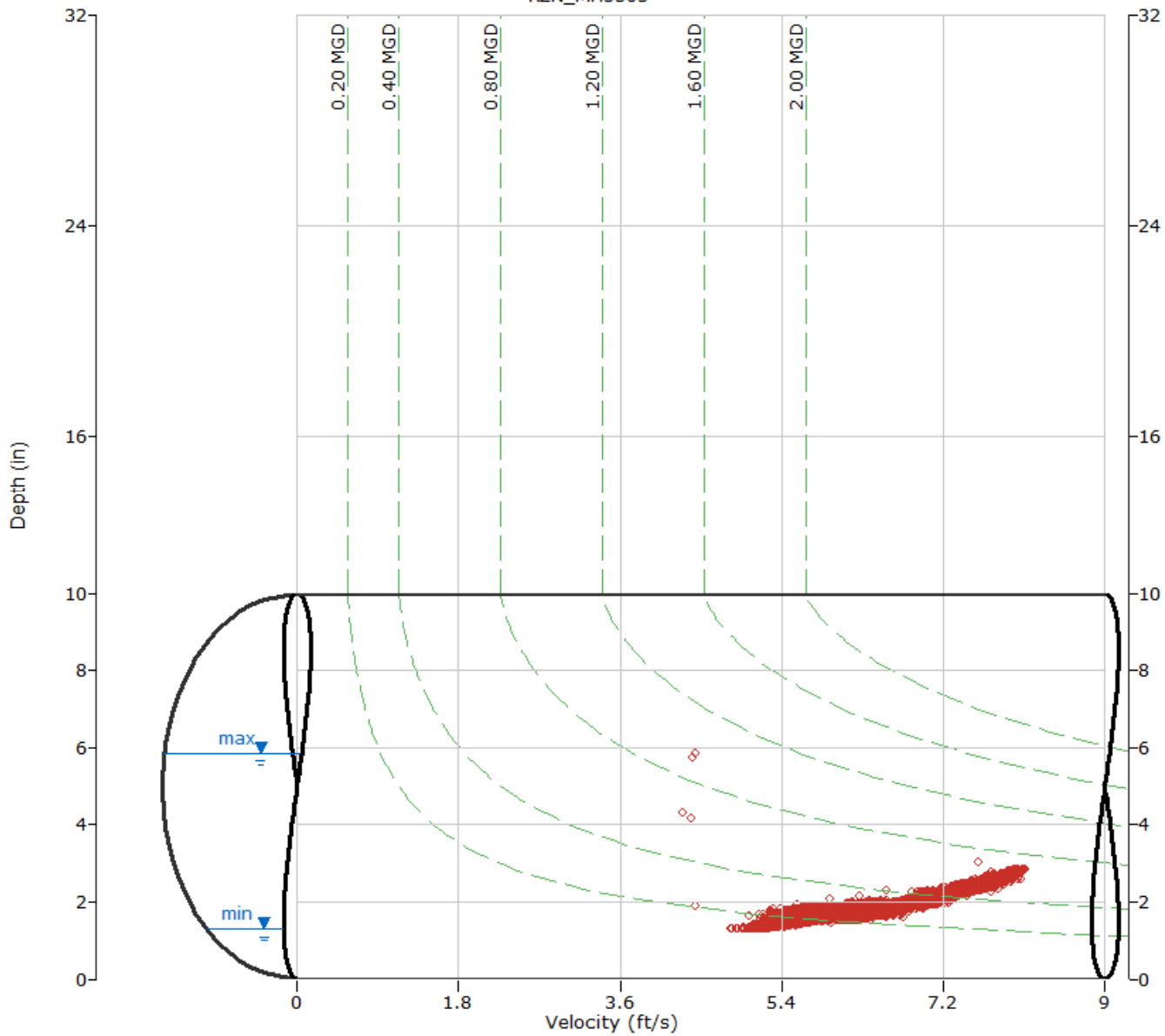

ADS Environmental Services

Pipe Height: 10.00

Date	REN_MH5505\mp1\DFINAL (inches)					REN_MH5505\mp1\VFINAL (feet/sec)					REN_MH5505\mp1\QFINAL (MGD - Total MG)					
	Time	Min.	Time	Max.	Average	Time	Min.	Time	Max.	Average	Time	Min.	Time	Max.	Average	Total
12/22/2017	3:30	1.6	10:55	2.0	1.8	3:30	6.3	11:30	7.2	6.7	3:30	0.231	10:55	0.369	0.296	0.296
12/23/2017	5:40	1.5	10:55	2.0	1.8	5:25	6.1	9:45	7.2	6.6	5:35	0.214	10:55	0.365	0.276	0.276
12/24/2017	4:30	1.5	11:10	2.0	1.7	5:45	6.0	9:55	7.1	6.5	3:50	0.204	11:05	0.362	0.262	0.262
12/25/2017	7:30	1.5	12:25	2.0	1.7	4:15	5.7	12:20	7.2	6.4	2:45	0.205	12:20	0.356	0.252	0.252
12/26/2017	8:00	1.5	10:20	1.9	1.7	5:25	5.7	10:15	6.9	6.3	5:55	0.206	10:15	0.328	0.242	0.242
12/27/2017	7:05	1.5	11:10	1.9	1.6	2:40	5.7	19:00	6.8	6.2	4:30	0.205	11:10	0.311	0.234	0.234
12/28/2017	7:50	1.5	21:20	1.9	1.7	4:10	5.6	14:35	6.9	6.2	4:10	0.201	21:20	0.313	0.238	0.238
12/29/2017	1:55	1.6	17:15	2.7	2.3	0:55	6.0	12:00	7.9	7.2	1:30	0.214	17:15	0.601	0.447	0.447
12/30/2017	23:55	2.1	10:10	2.4	2.3	23:45	7.1	12:00	7.8	7.3	23:55	0.370	0:40	0.502	0.447	0.447
12/31/2017	23:20	1.9	10:40	2.3	2.1	23:25	6.8	10:35	7.4	7.1	23:25	0.324	10:35	0.450	0.369	0.369
ReportAvg	1.9					6.7					0.306					
ReportTotal											3.063					

ADS Environmental Services

Pipe Height: 10.00

Date	REN_MH5505\mp1\DFINAL (inches)					REN_MH5505\mp1\VFINAL (feet/sec)					REN_MH5505\mp1\QFINAL (MGD - Total MG)					
	Time	Min.	Time	Max.	Average	Time	Min.	Time	Max.	Average	Time	Min.	Time	Max.	Average	Total
1/1/2018	5:15	1.8	19:45	2.2	1.9	5:45	6.5	19:45	7.3	6.8	7:45	0.270	19:45	0.423	0.327	0.327
1/2/2018	3:35	1.6	20:40	2.0	1.8	3:15	6.2	19:25	7.2	6.6	3:25	0.231	20:40	0.362	0.291	0.291
1/3/2018	4:30	1.6	8:20	5.9	1.8	8:35	4.3	7:40	7.1	6.4	8:40	0.207	8:20	0.954	0.274	0.274
1/4/2018	2:00	1.6	18:50	2.0	1.7	2:30	5.9	20:10	6.9	6.4	5:00	0.216	18:50	0.347	0.254	0.254
1/5/2018	0:40	1.6	18:40	2.0	1.7	3:25	5.7	10:30	6.8	6.4	1:35	0.221	18:40	0.337	0.262	0.262
1/6/2018	3:30	1.6	10:20	2.1	1.9	4:05	6.1	11:30	7.3	6.7	4:05	0.227	10:20	0.385	0.313	0.313
1/7/2018	6:25	1.6	22:00	2.1	1.9	5:00	6.2	22:00	7.3	6.8	6:25	0.237	22:00	0.386	0.319	0.319
1/8/2018	3:10	1.8	7:45	2.1	2.0	1:50	6.6	10:40	7.3	6.9	3:10	0.286	7:50	0.386	0.341	0.341
1/9/2018	2:55	1.9	22:40	2.4	2.1	2:55	6.6	18:40	7.4	7.1	2:55	0.300	22:40	0.464	0.378	0.378
1/10/2018	3:15	2.0	7:25	2.2	2.1	4:05	6.8	7:25	7.3	7.1	3:15	0.341	7:25	0.429	0.374	0.374
1/11/2018	3:05	1.9	18:45	3.0	2.3	4:05	6.7	19:30	7.9	7.4	3:05	0.312	18:45	0.680	0.458	0.458
1/12/2018	23:55	2.3	8:30	2.6	2.4	23:55	7.4	8:30	7.7	7.6	23:55	0.461	8:30	0.551	0.500	0.500
1/13/2018	23:55	2.2	10:55	2.4	2.3	23:55	7.3	10:55	7.6	7.4	23:55	0.413	10:55	0.504	0.454	0.454
1/14/2018	5:10	2.1	10:20	2.3	2.2	5:10	7.0	10:20	7.5	7.2	5:10	0.366	10:20	0.472	0.409	0.409
1/15/2018	3:10	1.9	19:30	2.2	2.1	3:10	6.7	19:30	7.4	7.0	3:10	0.311	19:30	0.435	0.370	0.370
1/16/2018	2:35	1.8	9:35	2.2	2.0	2:35	6.5	9:35	7.3	7.0	2:35	0.281	9:35	0.419	0.354	0.354
1/17/2018	3:55	1.8	19:50	2.4	2.1	3:55	6.6	19:50	7.5	7.0	3:55	0.289	19:50	0.487	0.369	0.369
1/18/2018	2:50	2.2	6:40	2.5	2.3	23:50	7.2	18:10	7.6	7.4	2:50	0.404	6:40	0.507	0.455	0.455
1/19/2018	23:15	2.0	8:30	2.4	2.1	23:35	6.9	8:35	7.5	7.2	23:15	0.349	8:30	0.475	0.396	0.396
1/20/2018	6:45	1.9	11:10	2.3	2.0	4:35	6.7	11:10	7.4	7.0	6:45	0.308	11:10	0.463	0.360	0.360
1/21/2018	5:15	1.7	12:00	2.3	2.0	3:55	6.4	12:00	7.2	6.9	3:55	0.264	12:00	0.432	0.339	0.339
1/22/2018	2:20	1.7	18:40	2.1	1.9	2:30	6.4	20:35	7.2	6.8	2:30	0.249	18:40	0.399	0.327	0.327
1/23/2018	3:20	1.7	19:20	2.4	2.0	3:15	6.3	19:15	7.4	6.9	3:15	0.250	19:20	0.479	0.354	0.354
1/24/2018	2:50	2.2	20:55	2.5	2.4	2:30	7.2	23:25	7.6	7.4	2:50	0.413	20:55	0.527	0.474	0.474
1/25/2018	23:55	2.2	8:05	2.4	2.3	23:55	7.2	7:45	7.6	7.4	23:55	0.407	8:00	0.503	0.458	0.458
1/26/2018	3:45	2.0	8:55	2.3	2.2	3:05	6.8	13:55	7.5	7.2	3:30	0.350	8:50	0.454	0.405	0.405
1/27/2018	0:50	2.1	12:50	2.6	2.4	0:50	7.1	11:30	7.8	7.5	0:50	0.384	10:45	0.560	0.491	0.491
1/28/2018	23:55	2.1	11:05	2.4	2.3	6:30	7.1	11:00	7.7	7.3	23:55	0.370	11:00	0.508	0.442	0.442
1/29/2018	3:30	2.0	20:35	2.7	2.3	2:50	6.8	19:35	8.0	7.3	3:30	0.332	20:35	0.590	0.444	0.444
1/30/2018	23:55	2.1	7:05	2.5	2.4	12:40	7.2	8:25	7.7	7.4	23:55	0.392	7:05	0.531	0.475	0.475
1/31/2018	23:35	1.9	7:10	2.3	2.1	23:55	6.8	8:20	7.4	7.1	23:35	0.328	7:10	0.454	0.378	0.378
ReportAvg	2.1					7.1					0.382					
ReportTotal											11.84					

ADS Environmental Services

Pipe Height: 10.00

Date	REN_MH5505\mp1\DFINAL (inches)					REN_MH5505\mp1\VFINAL (feet/sec)					REN_MH5505\mp1\QFINAL (MGD - Total MG)					
	Time	Min.	Time	Max.	Average	Time	Min.	Time	Max.	Average	Time	Min.	Time	Max.	Average	Total
2/1/2018	3:45	1.8	21:10	2.3	2.0	2:40	6.5	21:55	7.4	6.9	3:45	0.281	21:55	0.454	0.345	0.345
2/2/2018	4:15	2.0	8:40	2.4	2.1	4:10	6.9	8:45	7.4	7.2	4:10	0.347	8:40	0.476	0.393	0.393
2/3/2018	4:00	1.9	10:35	2.3	2.1	4:15	6.7	21:30	7.3	7.1	4:10	0.314	10:35	0.461	0.375	0.375
2/4/2018	5:10	1.9	12:05	2.4	2.1	23:25	6.7	12:05	7.5	7.1	23:25	0.325	12:05	0.487	0.387	0.387
2/5/2018	3:40	1.8	18:05	2.1	2.0	3:35	6.5	18:05	7.5	6.9	3:45	0.278	18:05	0.414	0.336	0.336
2/6/2018	3:40	1.7	21:10	2.0	1.8	3:40	6.3	7:20	7.2	6.7	3:40	0.246	21:05	0.368	0.302	0.302
2/7/2018	3:55	1.6	20:25	2.0	1.8	3:50	6.1	9:45	7.1	6.6	3:50	0.220	20:25	0.354	0.276	0.276
2/8/2018	3:55	1.6	18:30	2.0	1.7	3:30	6.0	7:45	7.0	6.4	3:55	0.217	18:30	0.341	0.260	0.260
2/9/2018	2:35	1.6	8:05	1.9	1.7	3:30	5.9	8:05	7.0	6.4	2:35	0.215	8:05	0.337	0.253	0.253
2/10/2018	6:50	1.6	10:25	1.9	1.7	4:25	5.8	10:25	6.8	6.3	5:00	0.217	10:25	0.330	0.252	0.252
2/11/2018	1:10	1.6	11:00	2.0	1.7	5:05	5.6	9:35	6.8	6.3	5:05	0.206	10:55	0.335	0.251	0.251
2/12/2018	2:55	1.5	20:40	1.8	1.6	3:15	5.5	21:25	6.7	6.1	3:15	0.190	20:40	0.288	0.231	0.231
2/13/2018	3:15	1.5	19:50	1.8	1.6	2:30	5.5	19:45	6.8	6.1	3:15	0.185	19:50	0.291	0.225	0.225
2/14/2018	3:35	1.5	19:25	1.9	1.7	2:15	5.6	8:30	6.6	6.1	3:35	0.186	19:25	0.298	0.233	0.233
2/15/2018	3:20	1.6	7:10	1.9	1.7	2:10	5.5	7:10	6.7	6.0	2:10	0.207	7:10	0.312	0.245	0.245
2/16/2018	1:25	1.6	8:00	2.0	1.7	2:30	5.4	7:50	6.5	6.0	1:25	0.200	7:55	0.312	0.245	0.245
2/17/2018	3:05	1.6	11:50	2.0	1.7	4:50	5.5	10:05	6.7	6.0	3:05	0.192	11:50	0.327	0.248	0.248
2/18/2018	3:35	1.6	12:35	1.9	1.7	3:25	5.5	12:40	6.4	5.9	3:25	0.207	12:35	0.306	0.245	0.245
2/19/2018	3:25	1.5	19:10	1.9	1.7	2:55	5.3	19:10	6.6	5.9	3:25	0.187	19:10	0.299	0.234	0.234
2/20/2018	3:30	1.5	8:15	1.8	1.7	3:10	5.4	19:55	6.4	5.8	3:30	0.183	8:15	0.269	0.223	0.223
2/21/2018	3:15	1.5	20:20	1.7	1.6	3:20	5.3	20:20	6.5	5.8	3:20	0.168	20:20	0.268	0.217	0.217
2/22/2018	2:40	1.4	20:15	1.8	1.6	3:20	5.2	13:15	6.4	5.7	2:40	0.165	20:15	0.267	0.211	0.211
2/23/2018	3:10	1.4	8:10	1.7	1.6	3:35	5.1	19:40	6.4	5.7	3:10	0.154	19:45	0.253	0.204	0.204
2/24/2018	4:00	1.4	11:35	1.8	1.6	2:50	5.1	10:20	6.4	5.7	4:00	0.155	11:30	0.275	0.210	0.210
2/25/2018	3:45	1.4	12:55	1.9	1.6	5:05	5.2	15:05	6.4	5.8	3:40	0.159	12:55	0.289	0.218	0.218
2/26/2018	4:05	1.4	20:25	1.7	1.6	4:20	5.1	19:15	6.3	5.7	4:15	0.152	20:25	0.257	0.208	0.208
2/27/2018	3:40	1.4	20:35	1.8	1.6	2:25	5.1	19:00	6.5	5.8	2:25	0.149	20:35	0.272	0.207	0.207
2/28/2018	3:45	1.4	20:40	1.9	1.6	2:45	5.2	20:40	6.6	5.9	2:45	0.160	20:40	0.297	0.218	0.218
ReportAvg	1.7					6.2					0.259					
ReportTotal											7.250					

ADS Environmental Services

Pipe Height: 10.00

Date	REN_MH5505\mp1\DFINAL (inches)					REN_MH5505\mp1\VFINAL (feet/sec)					REN_MH5505\mp1\QFINAL (MGD - Total MG)					
	Time	Min.	Time	Max.	Average	Time	Min.	Time	Max.	Average	Time	Min.	Time	Max.	Average	Total
3/1/2018	3:40	1.5	18:35	1.8	1.6	2:30	5.6	18:30	6.6	6.1	3:40	0.193	18:35	0.290	0.233	0.233
3/2/2018	3:15	1.5	8:45	1.8	1.6	3:25	5.6	8:00	6.7	6.1	3:25	0.192	8:05	0.292	0.234	0.234
3/3/2018	3:15	1.5	10:20	1.9	1.7	4:10	5.5	10:20	6.7	6.1	4:10	0.189	10:20	0.322	0.233	0.233
3/4/2018	4:30	1.5	20:30	1.8	1.6	4:30	5.4	20:30	6.7	6.0	4:30	0.177	20:30	0.292	0.228	0.228
3/5/2018	3:40	1.5	19:45	1.8	1.6	3:40	5.4	19:45	6.7	6.0	3:40	0.172	19:45	0.285	0.221	0.221
3/6/2018	2:35	1.4	20:20	1.7	1.6	2:35	5.3	20:20	6.8	5.9	2:35	0.166	20:20	0.281	0.215	0.215
3/7/2018	3:50	1.4	19:55	1.8	1.6	2:25	5.3	19:50	6.8	6.0	2:25	0.164	19:50	0.285	0.214	0.214
3/8/2018	3:20	1.4	21:10	1.8	1.6	3:15	5.4	21:10	6.8	6.0	3:15	0.162	21:10	0.287	0.212	0.212
3/9/2018	4:30	1.5	8:05	1.8	1.6	2:30	5.5	8:00	6.7	6.0	4:30	0.176	8:05	0.295	0.217	0.217
3/10/2018	3:40	1.4	9:15	1.9	1.6	4:35	5.5	11:05	6.8	6.1	3:35	0.172	11:05	0.309	0.220	0.220
3/11/2018	4:05	1.4	19:30	1.8	1.6	2:45	5.4	19:25	6.7	6.0	4:45	0.166	19:30	0.294	0.218	0.218
3/12/2018	2:10	1.4	20:50	1.8	1.6	2:55	5.3	20:10	6.6	5.9	2:55	0.159	20:50	0.287	0.209	0.209
3/13/2018	2:50	1.4	19:30	1.8	1.6	2:50	5.3	19:30	6.7	5.9	2:50	0.158	19:30	0.279	0.206	0.206
3/14/2018	1:20	1.4	20:10	1.7	1.6	2:05	5.3	20:05	6.6	5.9	2:05	0.160	20:05	0.261	0.209	0.209
3/15/2018	2:05	1.4	19:05	1.7	1.6	1:45	5.3	8:15	6.6	5.9	2:05	0.162	20:30	0.260	0.211	0.211
3/16/2018	2:00	1.4	8:40	1.7	1.6	2:25	5.4	13:40	6.6	5.8	2:00	0.155	8:40	0.271	0.205	0.205
3/17/2018	3:20	1.4	8:30	1.9	1.6	2:50	5.2	8:30	6.6	5.9	3:20	0.151	8:30	0.296	0.206	0.206
3/18/2018	4:35	1.3	10:40	1.8	1.6	3:30	5.2	10:40	6.6	5.8	4:15	0.146	10:40	0.293	0.206	0.206
3/19/2018	1:40	1.3	18:50	1.8	1.5	1:05	5.1	18:50	6.6	5.8	1:50	0.141	18:50	0.274	0.198	0.198
3/20/2018	2:35	1.3	20:25	1.7	1.5	1:30	5.1	18:05	6.4	5.7	1:30	0.141	20:25	0.247	0.193	0.193
3/21/2018	2:05	1.3	6:10	1.7	1.5	0:55	5.0	18:55	6.4	5.7	1:55	0.137	6:10	0.244	0.189	0.189
3/22/2018	2:20	1.3	19:50	1.7	1.5	1:40	4.8	19:50	6.4	5.7	1:35	0.132	19:50	0.258	0.198	0.198
3/23/2018	2:40	1.3	7:00	1.8	1.6	1:35	5.2	11:00	6.5	5.9	2:40	0.147	7:00	0.273	0.211	0.211
3/24/2018	3:40	1.5	10:35	2.0	1.7	3:00	5.4	10:35	7.0	6.0	3:15	0.173	10:35	0.361	0.249	0.249
3/25/2018	2:15	1.7	10:20	2.0	1.8	2:15	5.3	13:00	6.6	6.0	2:15	0.205	13:00	0.330	0.265	0.265
3/26/2018	2:10	1.7	19:20	2.0	1.8	2:45	5.3	20:20	6.6	5.9	2:45	0.209	19:20	0.336	0.256	0.256
3/27/2018	23:40	1.5	9:35	2.0	1.7	2:10	5.3	9:35	6.6	5.9	23:45	0.184	9:35	0.325	0.235	0.235
3/28/2018	2:30	1.4	18:05	1.8	1.6	1:35	5.2	18:00	6.6	5.9	1:35	0.168	18:00	0.276	0.217	0.217
3/29/2018	2:10	1.4	20:10	1.7	1.6	2:05	5.3	20:10	6.7	5.9	2:05	0.162	20:10	0.277	0.214	0.214
3/30/2018	2:15	1.4	8:15	1.7	1.6	1:45	5.2	8:15	6.6	5.8	2:15	0.155	8:15	0.272	0.211	0.211
3/31/2018	3:55	1.4	11:35	1.8	1.6	3:50	5.2	13:00	6.5	5.8	3:50	0.150	11:35	0.273	0.209	0.209
ReportAvg	1.6					5.9					0.217					
ReportTotal											6.742					

ADS Environmental Services

Pipe Height: 10.00

Date	REN_MH5505\mp1\DFINAL (inches)					REN_MH5505\mp1\VFINAL (feet/sec)					REN_MH5505\mp1\QFINAL (MGD - Total MG)					
	Time	Min.	Time	Max.	Average	Time	Min.	Time	Max.	Average	Time	Min.	Time	Max.	Average	Total
4/1/2018	4:20	1.3	8:25	1.8	1.6	3:50	5.1	8:25	6.7	5.8	4:20	0.144	8:25	0.297	0.216	0.216
4/2/2018	2:05	1.4	8:20	1.7	1.6	1:10	5.1	20:55	6.5	5.7	2:05	0.149	8:20	0.260	0.205	0.205
4/3/2018	2:25	1.3	19:00	1.7	1.5	2:25	5.0	19:00	6.5	5.7	2:25	0.140	19:00	0.265	0.200	0.200
4/4/2018	2:25	1.3	20:55	1.9	1.7	10:20	5.0	20:55	6.5	5.7	2:20	0.140	20:55	0.306	0.219	0.219
4/5/2018	1:05	1.5	19:35	1.9	1.7	0:40	5.2	19:35	6.6	5.8	1:05	0.174	19:35	0.301	0.237	0.237
4/6/2018	2:40	1.5	19:15	1.8	1.7	2:00	5.2	21:00	6.5	5.9	2:40	0.181	19:15	0.290	0.240	0.240
4/7/2018	1:25	1.4	9:50	2.1	1.8	2:00	5.3	19:00	7.1	6.3	1:25	0.170	9:50	0.369	0.279	0.279
4/8/2018	3:55	1.7	11:10	2.3	2.0	2:40	6.1	11:10	7.3	6.8	2:40	0.247	11:10	0.453	0.336	0.336
4/9/2018	23:55	1.7	20:00	2.1	1.9	1:15	6.3	7:05	7.2	6.7	23:55	0.252	20:00	0.389	0.304	0.304
4/10/2018	23:50	1.6	19:10	2.0	1.8	1:35	6.1	21:10	7.3	6.6	1:35	0.228	21:10	0.358	0.281	0.281
4/11/2018	1:55	1.6	21:05	2.0	1.7	1:50	6.0	20:15	7.0	6.5	1:55	0.217	21:05	0.338	0.265	0.265
4/12/2018	1:25	1.6	7:50	2.0	1.7	3:00	6.1	10:45	7.1	6.5	3:00	0.224	21:10	0.338	0.270	0.270
4/13/2018	1:40	1.6	18:50	1.9	1.7	1:15	6.0	9:30	7.1	6.5	1:25	0.217	9:35	0.340	0.268	0.268
4/14/2018	1:00	1.7	19:40	2.9	2.2	2:30	6.4	20:55	8.1	7.4	0:35	0.257	19:40	0.671	0.441	0.441
4/15/2018	23:40	2.3	8:45	2.9	2.6	23:45	7.5	0:15	8.1	7.9	23:45	0.462	8:45	0.670	0.580	0.580
4/16/2018	3:00	2.3	19:45	2.6	2.4	3:10	7.3	19:45	8.0	7.6	3:10	0.437	19:45	0.579	0.485	0.485
4/17/2018	23:40	2.0	6:20	2.4	2.3	23:35	6.9	6:20	7.8	7.5	23:35	0.355	6:20	0.517	0.462	0.462
4/18/2018	23:50	1.9	6:20	2.3	2.1	23:55	6.6	17:40	7.3	6.9	23:55	0.309	17:40	0.443	0.370	0.370
4/19/2018	23:55	1.8	7:35	2.3	2.0	23:55	6.4	20:40	7.1	6.8	23:55	0.273	7:35	0.422	0.330	0.330
4/20/2018	23:55	1.7	7:20	2.1	1.8	23:55	6.2	8:25	7.0	6.6	23:55	0.240	7:20	0.373	0.291	0.291
4/21/2018	23:45	1.6	8:20	2.1	1.8	2:30	5.9	12:00	6.9	6.4	2:30	0.212	8:20	0.362	0.267	0.267
4/22/2018	4:50	1.5	9:45	2.0	1.7	4:25	5.5	20:25	6.9	6.3	4:25	0.189	9:45	0.344	0.256	0.256
ReportAvg	1.9					6.5					0.309					
ReportTotal											6.803					

REN_MH5519

Located At: Access via Talbot Rd S (see attached site report for details)
Monitoring Period: December 22, 2017 – April 22, 2018
Pipe Dimensions: 10.25"
Finalized Silt Level: 0 mm

Site Data Characteristics: This site is located in a sanitary sewer pipe. The scattergraph indicates site operated in free flow conditions. The site did surcharge during the monitoring period. The dry weather data plots above the Froude =1 curve indicating supercritical flow.

Site Data Bias & Editing: The depth and velocity measurements recorded by the flow monitor were consistent with field confirmations conducted to date and supported the relative accuracy of the flow monitor at this location. The finalized depth data utilized the upward ultrasonic sensor.

Site Data Uptime: The data uptime achieved during the monitoring period is provided in the table below. Based upon the quality and consistency of the observed flow depth and velocity data, the Continuity equation was used to calculate the flow rate for the monitoring period.

Entity	Percentage Uptime	
	Raw	Final
Depth (in)	100%	100%
Velocity (f/s)	100%	100%
Quantity (mgd)	100%	100%

Site Data Summary: The average flow depth, velocity, and quantity data observed during the monitoring period along with observed minimum and maximum data, are provided in the following table. The minimum and maximum rates recorded in the tables are based on 5-minute data intervals.

Item	Depth (in)	Velocity (f/s)	Quantity (mgd)	% Full
Minimum	1.25	0.38	0.073	12%
Maximum	25.79	7.68	0.932	100%
Average	3.59	5.32	0.319	35%

Renton.Carollo.I&I.WA17



Site Name

REN_MH5519

Flow Monitoring Site Report

Site Address /Location:

Access Via Talbot Rd S

Monitor Series

TRITON+

Location Type

Temporary

Site Access Details:

Off of Talbot Rd, in brush area.

Latitude:

Longitude:

Pipe Size (H x W)

10.25" x 10.25"

Pipe Shape

Circular

Manhole #

MH5519

System Characteristics

Other

Access

Traffic

Drive

Light

Map



Installation Information

Installation Date:

12.14.17

Installation Type:

Doppler Special Installation

Monitoring Location (Sensors):

Upstream 0-5 FT

Monitor Location:

Manhole

Sensors / Devices:

Peak Combo (CS4)

Pressure Sensor Range (psi)

0 - 5 psi

Installation Confirmation:

Confirmation Time:

-

Pipe Size (HxW)

10.25" x 10.25"

Depth of Flow (Wet DOF) (in)

~2.25"

Range (Air DOF) (in)

Downlooker Physical Offset (in)

1.38"

Measurement Confidence (in)

0.25"

Peak Velocity (fps)

~6.00 FPS

Velocity Sensor Offset (in)

Silt (in)

0

Silt Type

Hydraulic Comments:

Low, fast flow

Manhole / Pipe Information:

Manhole Depth (Approx. FT):

~8'

Manhole Configuration

Single

Manhole Material:

Concrete

Manhole Condition:

Good

Manhole Opening Diameter (in)

20"

Manhole Diameter (Approx.):

20"

Manhole Cover

Vented

Manhole Frame

Normal

Active Drop Connections

No

Air Quality:

Normal

Pipe Material

PVC

Pipe Condition:

Good

Communication Information:

Communication Type

Wireless

Antenna Location

Manhole Pick / Vent Hole

Additional Site Info. / Comments:

Off trail. Confirmation information available from ADS.

ADS Project Name:

Renton.Carollo.I&I.WA17

ADS Project Number:

22275.11.325



Additional Photos

Upstream



Downstream



Side Inlet



Second Side Inlet (usually dry)



Top Down



Secondary Top Down - Outlet Oriented



Location



- Flow Direction
- ⊗ Monitoring Point

HYDROGRAPH REPORT

REN_MH5519

Flow Monitor
REN_MH5519

Pipe Height
10.25 in

Report Period
12/22/2017
To
4/22/2018

Legend
— Depth
— Velocity
— Rain

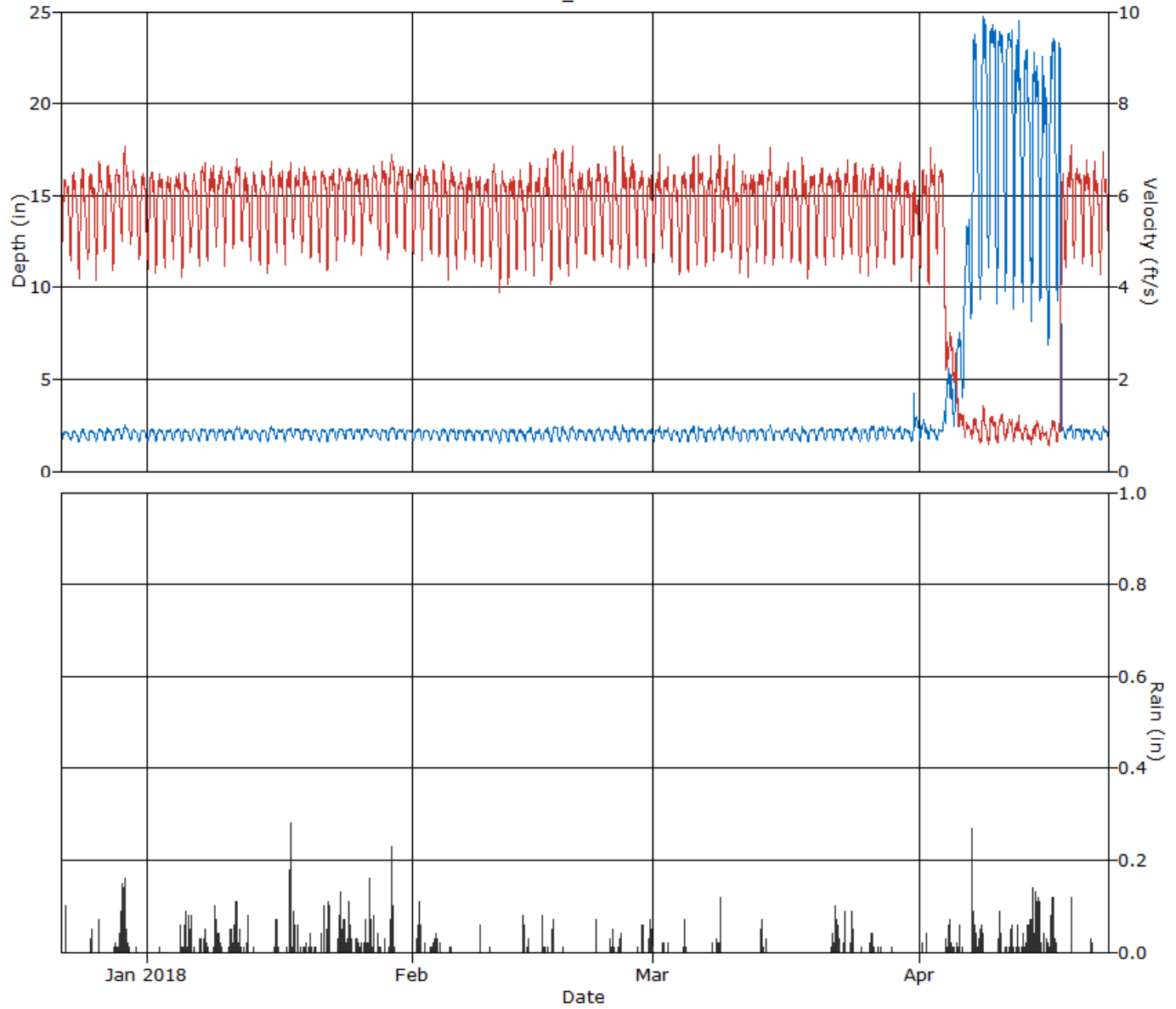

HYDROGRAPH REPORT

REN_MH5519

Flow Monitor
REN_MH5519

Pipe Height
10.25 in.

Report Period
12/22/2017
To
4/22/2018

Legend
— Quantity
— Rain

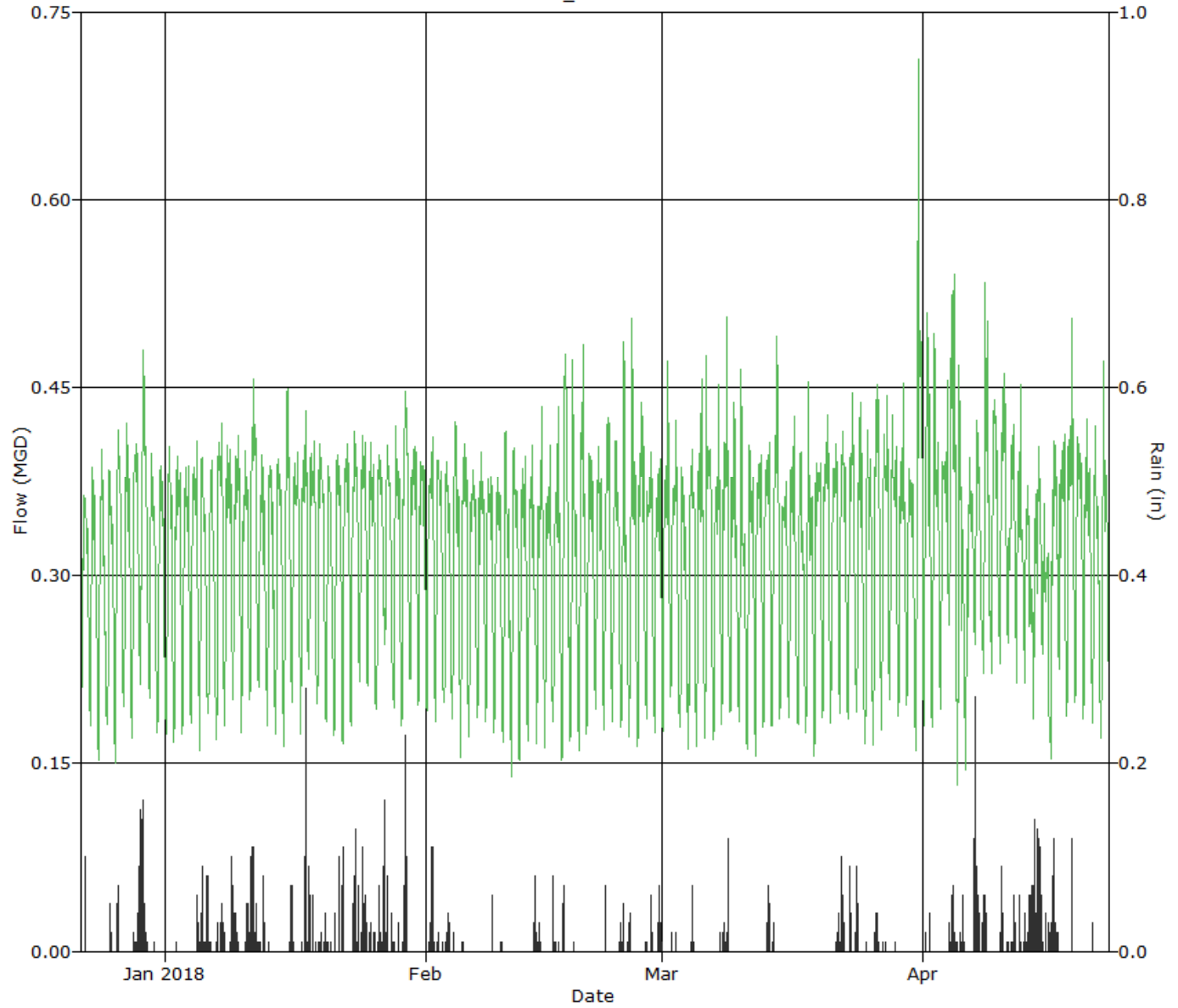

SCATTERGRAPH REPORT

REN_MH5519

Flow Monitor
REN_MH5519

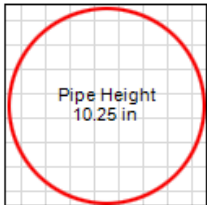

Report Period
12/22/2017
To
4/22/2018

- Legend
- Depth - Velocity
 - - - Iso-Q™
 - - - Silt
 - ▼ Min-Max Depth

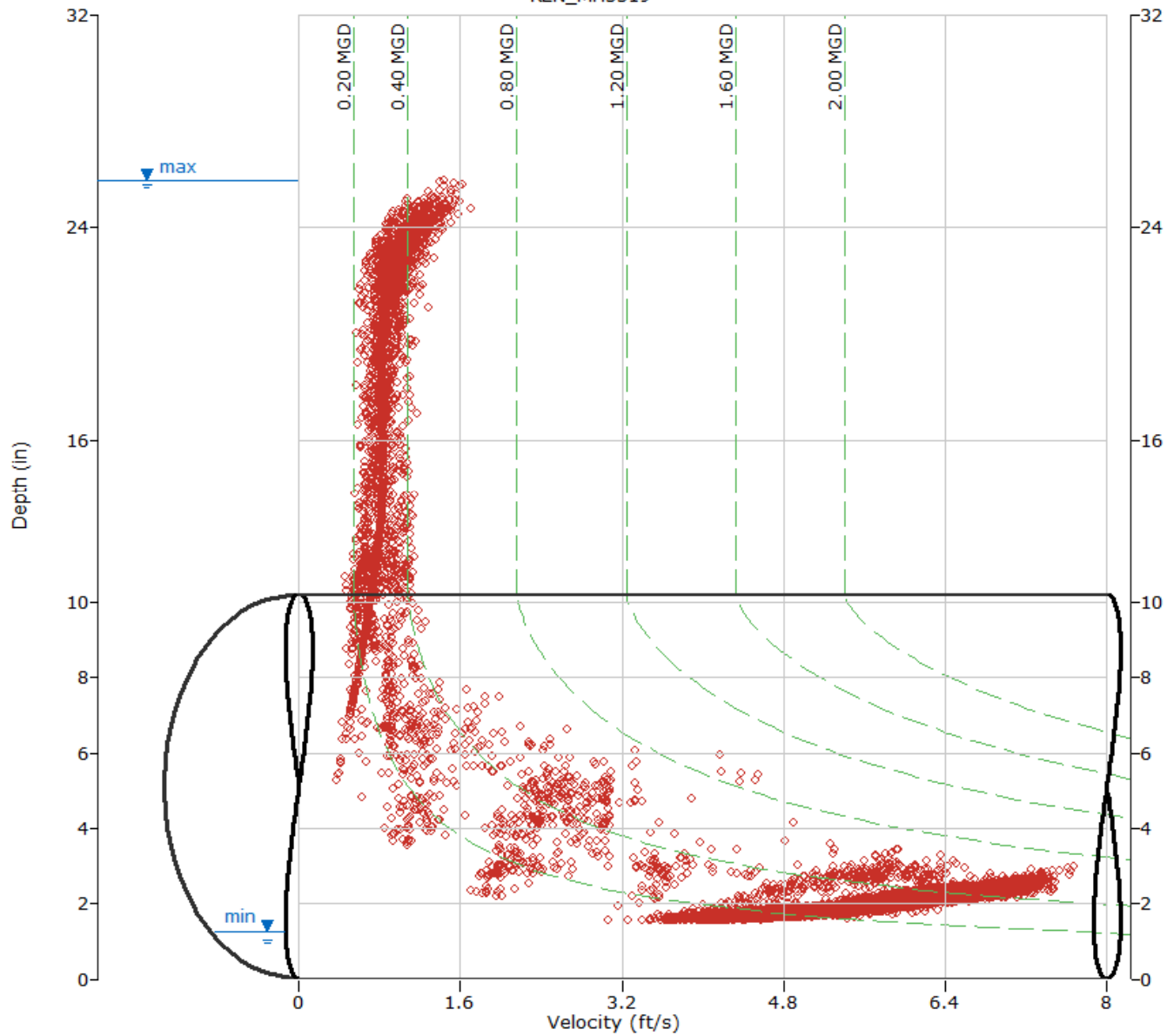

ADS Environmental Services

Pipe Height: 10.25

Date	REN_MH5519\mp1\DFINAL (inches)					REN_MH5519\mp1\VFINAL (feet/sec)					REN_MH5519\mp1\QFINAL (MGD - Total MG)						REN_RG\mp1\RAIN (inches)	
	Time	Min.	Time	Max.	Average	Time	Min.	Time	Max.	Average	Time	Min.	Time	Max.	Average	Total	Total	
12/22/2017	2:15	1.7	18:45	2.4	2.0	2:35	4.2	10:30	7.1	5.8	2:35	0.164	18:45	0.467	0.302	0.302	0.10	
12/23/2017	5:10	1.6	11:30	2.3	2.0	5:10	4.1	8:50	7.0	5.7	5:10	0.155	8:50	0.434	0.293	0.293	0.00	
12/24/2017	4:00	1.6	12:55	2.4	2.0	4:00	3.7	14:05	7.3	5.6	4:00	0.131	14:05	0.484	0.286	0.286	0.00	
12/25/2017	4:05	1.6	18:40	2.4	2.0	4:00	4.1	10:35	7.1	5.7	4:00	0.154	10:35	0.452	0.291	0.291	0.14	
12/26/2017	3:20	1.6	14:15	2.4	2.0	3:00	3.6	13:25	7.5	5.8	3:20	0.129	13:25	0.492	0.307	0.307	0.17	
12/27/2017	3:20	1.7	13:10	2.5	2.0	1:50	4.2	13:10	7.2	5.9	3:30	0.165	13:10	0.498	0.315	0.315	0.00	
12/28/2017	2:50	1.6	16:15	2.5	2.1	3:15	3.9	9:35	7.2	5.9	2:35	0.145	16:15	0.507	0.317	0.317	0.25	
12/29/2017	3:10	1.7	10:55	2.7	2.2	3:10	4.5	10:55	7.6	6.2	3:10	0.183	10:55	0.610	0.358	0.358	1.57	
12/30/2017	5:05	1.7	9:45	2.3	2.0	5:00	4.5	20:55	6.9	5.9	5:05	0.178	10:50	0.430	0.309	0.309	0.02	
12/31/2017	4:55	1.6	11:35	2.4	2.0	5:20	4.1	12:05	7.1	5.7	5:20	0.152	11:35	0.468	0.294	0.294	0.00	
ReportAvg	2.0					5.8					0.307							
ReportTotal											3.072						2.25	

ADS Environmental Services

Pipe Height: 10.25

Date	REN_MH5519\mp1\DFINAL (inches)					REN_MH5519\mp1\VFINAL (feet/sec)					REN_MH5519\mp1\QFINAL (MGD - Total MG)					REN_RG\mp1\RAIN (inches)	
	Time	Min.	Time	Max.	Average	Time	Min.	Time	Max.	Average	Time	Min.	Time	Max.	Average	Total	Total
1/1/2018	5:15	1.6	9:05	2.4	2.0	5:15	3.7	15:15	7.2	5.7	5:15	0.132	15:15	0.474	0.298	0.298	0.00
1/2/2018	4:45	1.6	12:15	2.6	2.0	1:55	3.9	12:15	7.3	5.8	1:55	0.146	12:15	0.537	0.307	0.307	0.01
1/3/2018	3:00	1.6	13:05	2.6	2.0	2:50	3.8	9:40	7.0	5.8	4:30	0.144	13:05	0.520	0.309	0.309	0.00
1/4/2018	4:10	1.6	13:05	2.6	2.1	4:00	4.2	12:05	7.2	5.9	4:10	0.157	13:05	0.534	0.317	0.317	0.09
1/5/2018	3:20	1.6	11:05	2.7	2.0	2:50	3.9	11:05	7.3	5.8	2:50	0.146	11:05	0.557	0.305	0.305	0.42
1/6/2018	2:45	1.6	13:00	2.4	2.0	1:25	4.3	11:25	7.0	5.7	2:45	0.167	13:00	0.438	0.296	0.296	0.24
1/7/2018	4:50	1.6	19:05	2.5	2.0	4:35	3.7	19:05	7.3	5.9	4:45	0.135	19:05	0.508	0.315	0.315	0.38
1/8/2018	2:35	1.6	12:05	2.5	2.1	2:15	4.2	19:15	7.3	5.9	2:15	0.158	12:05	0.502	0.322	0.322	0.14
1/9/2018	3:40	1.7	11:15	2.5	2.1	3:40	4.5	11:15	7.3	6.0	3:40	0.177	11:15	0.524	0.327	0.327	0.46
1/10/2018	2:55	1.6	17:35	2.4	2.0	2:30	4.0	18:30	7.1	5.9	2:30	0.155	18:30	0.473	0.316	0.316	0.22
1/11/2018	2:30	1.7	13:10	3.0	2.1	2:30	3.9	13:10	7.6	6.1	2:30	0.152	13:10	0.675	0.352	0.352	1.04
1/12/2018	4:50	1.7	16:05	2.9	2.1	3:35	4.5	16:05	7.5	5.9	3:35	0.186	16:05	0.636	0.318	0.318	0.20
1/13/2018	4:35	1.7	11:30	2.4	2.0	1:45	4.1	11:30	7.1	5.8	1:45	0.163	11:30	0.463	0.305	0.305	0.02
1/14/2018	5:30	1.6	9:40	2.4	2.0	3:55	4.1	16:40	7.1	5.8	3:55	0.158	9:40	0.470	0.304	0.304	0.00
1/15/2018	4:00	1.6	11:25	2.5	2.1	3:05	4.1	14:45	7.3	5.8	3:05	0.156	14:45	0.515	0.322	0.322	0.04
1/16/2018	4:45	1.7	11:20	2.5	2.1	4:30	4.4	11:20	7.2	5.9	4:30	0.179	11:20	0.502	0.323	0.323	0.26
1/17/2018	4:10	1.6	18:35	2.6	2.1	4:10	4.2	18:35	7.2	5.9	4:10	0.156	18:35	0.530	0.331	0.331	0.79
1/18/2018	1:40	1.7	13:40	2.6	2.1	1:30	4.3	13:40	7.3	6.0	1:30	0.176	13:40	0.536	0.336	0.336	0.40
1/19/2018	3:30	1.6	19:20	2.5	2.1	3:30	4.0	12:35	7.1	6.0	3:30	0.151	19:20	0.490	0.323	0.323	0.10
1/20/2018	4:40	1.6	15:05	2.4	2.0	4:00	4.1	15:05	7.0	5.8	4:40	0.161	15:05	0.469	0.298	0.298	0.10
1/21/2018	3:40	1.6	20:00	2.5	2.0	4:10	3.9	11:55	7.1	5.8	4:10	0.141	20:00	0.500	0.309	0.309	0.16
1/22/2018	2:15	1.6	19:05	2.6	2.1	2:35	3.7	18:25	7.2	5.9	4:35	0.138	18:25	0.508	0.321	0.321	0.34
1/23/2018	3:55	1.6	14:35	2.7	2.1	3:25	4.0	14:35	7.4	5.9	3:25	0.154	14:35	0.587	0.327	0.327	0.79
1/24/2018	4:05	1.7	12:20	2.5	2.1	2:40	4.7	12:20	7.2	6.0	2:40	0.192	12:20	0.508	0.339	0.339	0.51
1/25/2018	2:30	1.7	14:05	2.4	2.1	1:55	4.5	14:00	7.0	6.0	2:30	0.184	14:05	0.467	0.330	0.330	0.14
1/26/2018	3:00	1.7	18:40	2.5	2.1	2:25	4.1	14:15	7.1	5.9	2:25	0.161	18:40	0.476	0.324	0.324	0.36
1/27/2018	5:20	1.8	15:20	2.4	2.1	6:10	5.0	17:40	7.0	6.1	6:10	0.214	15:20	0.462	0.331	0.331	0.61
1/28/2018	4:20	1.7	11:35	2.5	2.0	5:40	4.4	11:35	7.1	5.9	5:40	0.175	11:35	0.487	0.314	0.314	0.07
1/29/2018	2:35	1.6	13:35	2.7	2.1	2:20	4.0	13:35	7.5	6.1	2:20	0.157	13:35	0.592	0.342	0.342	0.90
1/30/2018	3:45	1.7	15:05	2.6	2.1	3:45	4.5	14:05	7.4	6.1	3:45	0.181	15:05	0.525	0.330	0.330	0.00
1/31/2018	3:25	1.6	10:10	2.6	2.1	2:45	3.8	10:10	7.5	6.0	2:45	0.148	10:10	0.560	0.324	0.324	0.00
ReportAvg	2.1					5.9					0.320						
ReportTotal																9.914	8.79

ADS Environmental Services

Pipe Height: 10.25

Date	REN_MH5519\mp1\DFINAL (inches)					REN_MH5519\mp1\VFINAL (feet/sec)					REN_MH5519\mp1\QFINAL (MGD - Total MG)						REN_RG\mp1\RAIN (inches)	
	Time	Min.	Time	Max.	Average	Time	Min.	Time	Max.	Average	Time	Min.	Time	Max.	Average	Total	Total	
2/1/2018	2:55	1.6	20:20	2.7	2.1	3:15	4.0	20:20	7.4	6.0	3:15	0.155	20:20	0.579	0.329	0.329	0.66	
2/2/2018	3:30	1.7	19:40	2.6	2.1	3:55	4.3	19:40	7.4	6.0	3:55	0.168	19:40	0.537	0.323	0.323	0.04	
2/3/2018	4:40	1.7	13:30	2.4	2.0	2:30	4.1	13:30	7.0	5.8	2:30	0.161	13:30	0.458	0.305	0.305	0.31	
2/4/2018	4:55	1.6	14:35	2.5	2.0	4:35	4.2	14:35	7.1	5.9	4:35	0.163	14:35	0.490	0.313	0.313	0.02	
2/5/2018	3:30	1.6	20:40	2.6	2.1	3:30	3.8	15:10	7.2	5.9	3:30	0.140	20:40	0.534	0.318	0.318	0.04	
2/6/2018	3:35	1.6	20:00	2.5	2.0	3:45	3.7	11:20	7.1	5.8	3:45	0.141	20:00	0.493	0.311	0.311	0.00	
2/7/2018	3:00	1.6	11:35	2.5	2.0	2:25	4.0	11:35	7.3	5.8	3:00	0.151	11:35	0.514	0.312	0.312	0.00	
2/8/2018	4:00	1.6	20:50	2.4	2.1	3:55	4.1	9:30	7.0	5.9	3:55	0.157	16:25	0.435	0.315	0.315	0.09	
2/9/2018	2:50	1.6	14:55	2.4	2.0	2:50	3.8	14:55	7.1	5.7	2:50	0.143	14:55	0.481	0.303	0.303	0.01	
2/10/2018	3:05	1.6	10:35	2.4	2.0	2:40	3.7	12:00	7.5	5.7	2:40	0.137	12:00	0.493	0.294	0.294	0.01	
2/11/2018	4:20	1.6	9:00	2.5	2.0	4:45	3.1	12:55	7.3	5.7	4:45	0.109	9:00	0.482	0.301	0.301	0.00	
2/12/2018	1:50	1.6	9:15	2.5	2.0	3:50	3.4	7:30	7.1	5.7	3:50	0.122	9:15	0.493	0.304	0.304	0.00	
2/13/2018	3:45	1.6	14:40	2.5	2.0	2:30	3.9	14:40	7.2	5.7	2:30	0.143	14:40	0.492	0.302	0.302	0.17	
2/14/2018	4:40	1.6	18:00	2.5	2.1	4:25	3.9	17:20	7.1	5.8	4:25	0.145	18:00	0.500	0.316	0.316	0.15	
2/15/2018	3:55	1.6	17:40	2.4	2.0	3:40	3.8	18:00	7.4	5.8	3:40	0.141	18:00	0.480	0.306	0.306	0.00	
2/16/2018	2:50	1.6	15:00	2.5	2.0	2:50	3.9	15:00	7.2	5.8	2:50	0.144	15:00	0.504	0.305	0.305	0.15	
2/17/2018	4:15	1.5	11:55	2.7	2.1	4:10	3.4	11:55	7.4	5.9	4:10	0.120	11:55	0.568	0.327	0.327	0.32	
2/18/2018	4:45	1.6	11:15	2.7	2.0	1:45	3.6	13:30	7.4	5.7	1:45	0.136	13:30	0.562	0.304	0.304	0.01	
2/19/2018	4:05	1.6	11:40	2.6	2.1	4:05	3.7	15:10	7.4	5.9	4:05	0.133	15:10	0.551	0.324	0.324	0.00	
2/20/2018	2:55	1.6	13:45	2.5	2.1	2:55	3.9	11:20	7.0	5.8	2:55	0.143	13:45	0.489	0.314	0.314	0.00	
2/21/2018	4:00	1.6	10:25	2.5	2.0	4:05	4.0	12:50	7.3	5.8	4:05	0.156	12:50	0.505	0.313	0.313	0.00	
2/22/2018	4:35	1.6	17:45	2.5	2.1	2:55	4.1	17:45	7.3	5.9	4:15	0.161	17:45	0.505	0.319	0.319	0.07	
2/23/2018	4:25	1.6	13:20	2.6	2.0	4:45	4.2	13:20	7.2	5.9	5:05	0.163	13:20	0.530	0.313	0.313	0.01	
2/24/2018	4:05	1.6	12:20	2.6	2.0	4:05	4.0	12:45	7.2	5.7	4:05	0.145	12:20	0.527	0.298	0.298	0.13	
2/25/2018	3:10	1.6	12:15	2.8	2.1	4:15	3.9	12:15	7.4	5.8	3:10	0.143	12:15	0.601	0.317	0.317	0.11	
2/26/2018	3:40	1.6	12:35	2.5	2.1	4:40	3.9	10:40	7.4	5.9	4:40	0.143	12:35	0.509	0.323	0.323	0.00	
2/27/2018	3:00	1.7	15:05	2.6	2.1	4:20	4.0	15:05	7.2	5.9	4:20	0.157	15:05	0.525	0.318	0.318	0.19	
2/28/2018	3:50	1.6	19:05	2.6	2.0	3:30	3.9	19:05	6.9	5.8	3:30	0.149	19:05	0.504	0.311	0.311	0.35	
ReportAvg	2.0					5.8					0.312							
ReportTotal																	8.738	2.84

ADS Environmental Services

Pipe Height: 10.25

Date	REN_MH5519\mp1\DFINAL (inches)					REN_MH5519\mp1\VFINAL (feet/sec)					REN_MH5519\mp1\QFINAL (MGD - Total MG)					REN_RG\mp1\RAIN (inches)	
	Time	Min.	Time	Max.	Average	Time	Min.	Time	Max.	Average	Time	Min.	Time	Max.	Average	Total	Total
3/1/2018	3:30	1.6	18:45	2.9	2.1	2:25	4.0	18:45	7.6	5.9	2:25	0.155	18:45	0.649	0.321	0.321	0.01
3/2/2018	2:10	1.7	14:00	2.6	2.1	1:20	4.4	14:00	7.2	5.9	4:05	0.179	14:00	0.517	0.317	0.317	0.07
3/3/2018	4:00	1.6	8:40	2.6	2.0	4:00	3.9	8:45	7.2	5.7	4:00	0.145	8:45	0.541	0.292	0.292	0.00
3/4/2018	3:20	1.6	11:55	2.5	2.0	2:25	4.0	12:30	7.2	5.8	2:25	0.148	11:55	0.487	0.304	0.304	0.12
3/5/2018	3:05	1.6	11:30	2.5	2.1	3:05	3.7	11:30	7.3	5.9	3:05	0.135	11:30	0.517	0.320	0.320	0.00
3/6/2018	3:15	1.6	7:05	2.7	2.1	3:00	3.9	7:05	7.3	6.0	3:00	0.142	7:05	0.571	0.334	0.334	0.00
3/7/2018	3:20	1.6	17:45	2.5	2.1	3:15	4.1	18:30	7.2	5.9	3:15	0.155	17:45	0.507	0.318	0.318	0.03
3/8/2018	3:30	1.6	18:35	2.8	2.1	1:05	4.0	18:45	7.4	6.0	1:05	0.151	18:35	0.604	0.333	0.333	0.37
3/9/2018	2:55	1.6	14:25	2.7	2.0	2:55	4.1	14:25	7.3	5.9	2:55	0.157	14:25	0.564	0.313	0.313	0.00
3/10/2018	5:15	1.6	10:05	2.5	2.0	3:25	4.0	10:35	7.2	5.7	3:25	0.152	10:35	0.507	0.297	0.297	0.00
3/11/2018	4:20	1.6	12:30	2.4	2.0	3:05	3.7	19:15	7.1	5.7	3:05	0.136	12:30	0.464	0.296	0.296	0.00
3/12/2018	3:20	1.6	13:30	2.5	2.1	2:30	3.8	14:45	7.2	5.8	2:30	0.140	14:45	0.500	0.314	0.314	0.00
3/13/2018	1:10	1.6	9:05	2.6	2.1	1:10	3.9	9:05	7.2	6.0	1:10	0.143	9:05	0.543	0.328	0.328	0.31
3/14/2018	3:00	1.6	17:05	3.0	2.1	2:55	4.0	17:05	7.7	6.0	2:55	0.150	17:05	0.693	0.342	0.342	0.04
3/15/2018	2:20	1.6	10:10	2.3	2.0	0:40	4.0	19:15	7.2	5.8	0:40	0.153	10:10	0.429	0.308	0.308	0.00
3/16/2018	2:10	1.6	7:35	2.5	2.0	2:05	4.1	7:35	7.2	5.8	2:05	0.159	7:35	0.499	0.312	0.312	0.00
3/17/2018	3:55	1.6	12:00	2.5	2.0	3:55	3.6	12:00	7.1	5.7	3:55	0.131	12:00	0.505	0.294	0.294	0.00
3/18/2018	1:40	1.6	10:25	2.7	2.0	1:40	3.8	10:25	7.2	5.8	1:40	0.141	10:25	0.562	0.304	0.304	0.00
3/19/2018	1:10	1.6	9:25	2.5	2.1	1:10	3.7	16:15	7.3	5.8	1:10	0.134	9:25	0.505	0.319	0.319	0.00
3/20/2018	2:45	1.6	16:20	2.7	2.1	2:45	3.7	12:45	7.2	5.9	2:45	0.137	16:20	0.549	0.329	0.329	0.00
3/21/2018	1:40	1.7	20:00	2.8	2.1	1:15	4.1	16:25	7.4	5.9	1:40	0.161	20:00	0.612	0.327	0.327	0.10
3/22/2018	2:20	1.6	10:20	2.6	2.1	2:20	3.9	10:20	7.3	5.9	2:20	0.147	10:20	0.550	0.327	0.327	0.48
3/23/2018	2:30	1.7	14:40	2.5	2.1	1:35	4.0	14:40	7.3	5.9	2:20	0.158	14:40	0.516	0.322	0.322	0.31
3/24/2018	3:30	1.6	11:00	2.6	2.0	3:20	4.2	11:00	7.4	5.8	3:20	0.166	11:00	0.535	0.311	0.311	0.28
3/25/2018	4:05	1.6	11:40	2.5	2.0	2:45	3.7	19:20	7.4	5.7	2:45	0.139	11:40	0.487	0.305	0.305	0.01
3/26/2018	2:15	1.6	13:00	2.8	2.1	1:05	3.6	13:00	7.4	5.9	1:05	0.140	13:00	0.619	0.339	0.339	0.17
3/27/2018	2:50	1.7	16:40	2.6	2.1	1:35	3.8	10:15	7.2	5.9	1:35	0.153	16:40	0.536	0.335	0.335	0.02
3/28/2018	2:25	1.7	9:55	2.6	2.1	1:35	4.1	9:55	7.2	5.9	1:35	0.168	9:55	0.548	0.335	0.335	0.01
3/29/2018	2:40	1.6	15:50	2.6	2.1	2:30	4.0	12:35	7.1	5.8	2:30	0.155	12:35	0.515	0.324	0.324	0.00
3/30/2018	2:25	1.7	8:50	2.5	2.1	2:55	4.1	8:50	7.0	5.8	2:25	0.167	8:50	0.494	0.312	0.312	0.00
3/31/2018	2:25	1.6	10:30	6.0	2.4	2:15	3.9	19:00	6.8	5.5	2:15	0.148	10:30	0.932	0.373	0.373	0.00
ReportAvg					2.1					5.8					0.320		
ReportTotal															9.906	2.33	

ADS Environmental Services

Pipe Height: 10.25

Date	REN_MH5519\mp1\DFINAL (inches)					REN_MH5519\mp1\VFINAL (feet/sec)					REN_MH5519\mp1\QFINAL (MGD - Total MG)					REN_RG\mp1\RAIN (inches)	
	Time	Min.	Time	Max.	Average	Time	Min.	Time	Max.	Average	Time	Min.	Time	Max.	Average	Total	Total
4/1/2018	3:30	1.6	18:35	3.1	2.3	1:15	4.2	10:40	7.4	5.7	3:30	0.154	10:50	0.618	0.351	0.351	0.10
4/2/2018	1:45	1.6	9:10	2.8	2.1	1:45	3.5	8:55	7.3	5.9	1:45	0.124	8:55	0.583	0.337	0.337	0.00
4/3/2018	2:25	1.7	22:55	4.8	2.2	23:45	3.3	10:05	7.5	5.8	2:25	0.171	21:55	0.689	0.345	0.345	0.00
4/4/2018	2:25	1.9	10:20	6.6	4.2	23:50	1.9	1:25	4.0	2.8	2:25	0.154	12:25	0.758	0.387	0.387	0.39
4/5/2018	2:30	2.2	13:50	8.4	5.5	18:40	0.9	6:35	3.0	1.6	2:00	0.109	6:35	0.646	0.295	0.295	0.25
4/6/2018	1:45	3.6	16:00	17.4	9.8	9:10	0.5	2:10	1.4	1.0	2:50	0.111	23:25	0.434	0.304	0.304	0.00
4/7/2018	1:45	7.8	10:00	24.9	17.3	1:45	0.6	8:30	1.4	0.9	1:45	0.173	8:30	0.533	0.336	0.336	0.88
4/8/2018	3:05	8.8	15:25	25.8	18.8	4:10	0.5	10:45	1.6	0.9	4:10	0.184	10:45	0.598	0.345	0.345	0.45
4/9/2018	3:10	9.8	18:45	25.2	20.4	3:10	0.5	12:50	1.7	1.0	3:10	0.188	12:50	0.634	0.356	0.356	0.00
4/10/2018	0:30	8.0	9:55	25.4	19.9	3:10	0.5	13:40	1.6	1.0	0:30	0.181	13:40	0.584	0.358	0.358	0.23
4/11/2018	23:55	7.6	9:35	24.9	20.0	23:55	0.5	13:00	1.3	0.9	23:55	0.161	13:00	0.481	0.343	0.343	0.31
4/12/2018	1:25	6.8	10:50	25.7	18.7	1:30	0.5	10:50	1.5	0.9	1:30	0.144	10:50	0.570	0.332	0.332	0.11
4/13/2018	1:05	4.8	13:10	24.4	18.1	1:10	0.5	13:10	1.2	0.8	1:05	0.108	13:10	0.442	0.301	0.301	0.51
4/14/2018	3:30	6.4	17:20	24.3	17.9	2:35	0.5	17:20	1.4	0.9	2:35	0.141	17:20	0.517	0.326	0.326	1.52
4/15/2018	23:55	6.4	9:40	23.9	16.6	23:55	0.4	10:10	1.2	0.8	23:55	0.105	10:10	0.435	0.290	0.290	0.21
4/16/2018	2:20	5.3	14:40	25.2	18.3	2:20	0.4	14:40	1.6	0.9	2:20	0.073	14:40	0.578	0.314	0.314	0.71
4/17/2018	12:50	1.3	11:25	24.8	10.3	2:05	0.5	19:15	7.1	3.3	2:05	0.139	10:35	0.566	0.335	0.335	0.01
4/18/2018	2:30	1.7	6:45	2.7	2.2	1:50	3.8	16:05	7.4	5.9	1:50	0.163	16:05	0.570	0.344	0.344	0.12
4/19/2018	3:55	1.7	17:45	2.7	2.1	2:25	3.8	17:45	7.3	6.0	2:25	0.162	17:45	0.577	0.334	0.334	0.00
4/20/2018	2:00	1.7	6:45	2.6	2.1	2:05	4.0	6:05	7.0	5.9	2:00	0.164	6:45	0.516	0.321	0.321	0.00
4/21/2018	3:20	1.7	11:45	2.5	2.0	2:20	4.0	11:45	7.4	5.8	2:20	0.163	11:45	0.517	0.305	0.305	0.05
4/22/2018	3:50	1.7	11:40	2.7	2.0	4:10	3.5	11:35	7.4	5.8	4:10	0.144	11:40	0.553	0.312	0.312	0.00
ReportAvg	10.6					2.9					0.330						
ReportTotal																7.270	5.85

REN_MH6041

Located At: Edmonds Ave and NE Sunset Blvd (see attached site report for details)
Monitoring Period: December 22, 2017 – April 22, 2018
Pipe Dimensions: 8"
Finalized Silt Level: 0 mm

Site Data Characteristics: This site is located in a sanitary sewer pipe. The scattergraph indicates site operated in free flow conditions. The site did not surcharge during the monitoring period. The dry weather data plots above the Froude =1 curve indicating supercritical flow.

Site Data Bias & Editing: The depth and velocity measurements recorded by the flow monitor were consistent with field confirmations conducted to date and supported the relative accuracy of the flow monitor at this location. The finalized depth data utilized the pressure sensor.



Site Data Uptime: The data uptime achieved during the monitoring period is provided in the table below. Based upon the quality and consistency of the observed flow depth and velocity data, the Continuity equation was used to calculate the flow rate for the monitoring period.

Entity	Percentage Uptime	
	Raw	Final
Depth (in)	100%	100%
Velocity (f/s)	100%	100%
Quantity (mgd)	100%	100%

Site Data Summary: The average flow depth, velocity, and quantity data observed during the monitoring period along with observed minimum and maximum data, are provided in the following table. The minimum and maximum rates recorded in the tables are based on 5-minute data intervals.

Item	Depth (in)	Velocity (f/s)	Quantity (mgd)	% Full
Minimum	0.15	0.56	0.002	2%
Maximum	5.66	8.17	0.640	71%
Average	0.91	3.76	0.056	11%

Additional Photos

Inlet	Outlet	Zoomed out inlet
		
Top Down	Location	Location Map
		
Google Earth Map	KEY	
	<p data-bbox="903 1218 1197 1250">→ Flow Direction</p> <p data-bbox="903 1299 1218 1331">⊗ Monitoring Point</p>	

HYDROGRAPH REPORT

REN_MH6041

Flow Monitor
REN_MH6041

Pipe Height
8.00 in

Report Period
12/22/2017
To
4/22/2018

Legend
— Depth
— Velocity

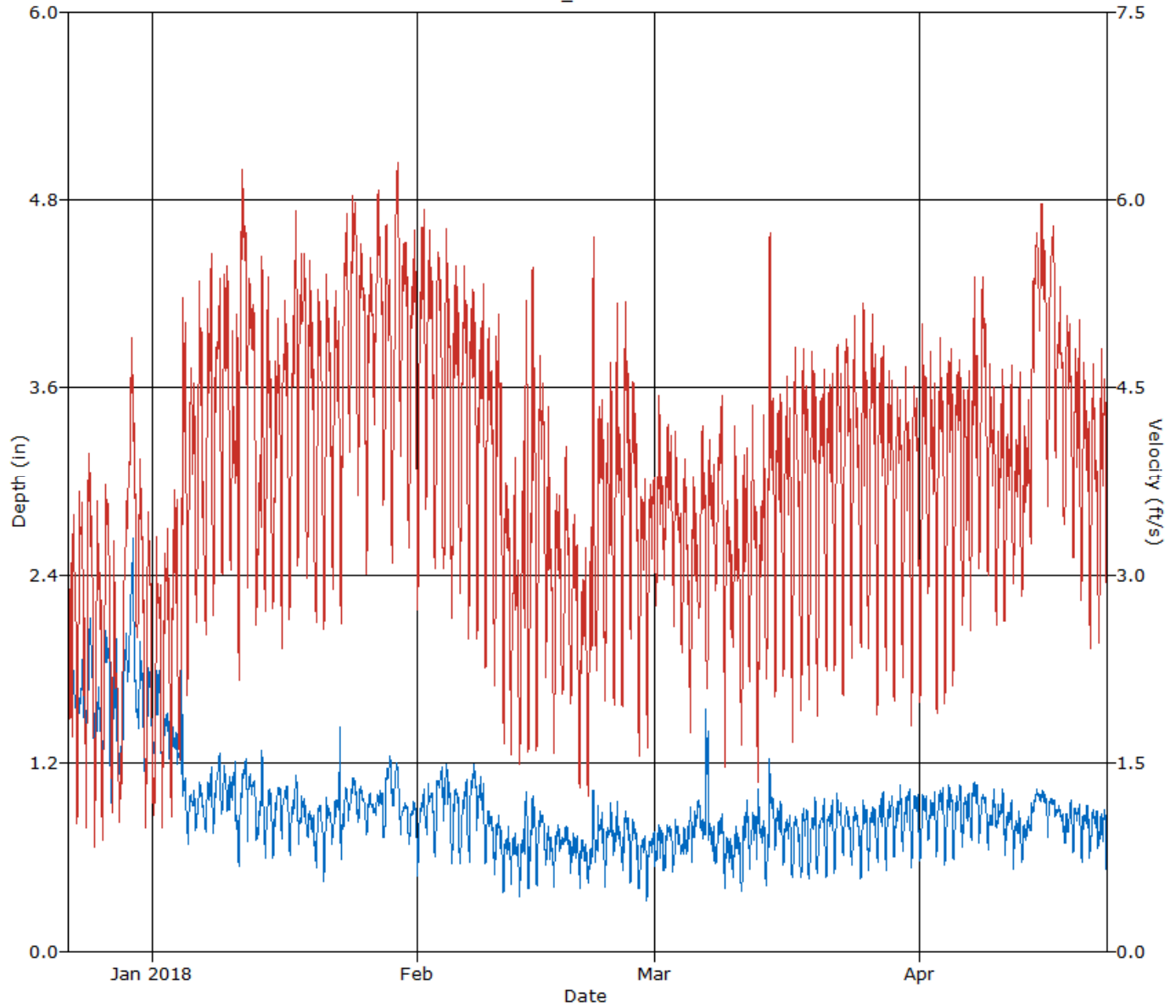

HYDROGRAPH REPORT

REN_MH6041

Flow Monitor
REN_MH6041

Pipe Height
8.00 in.

Report Period
12/22/2017
To
4/22/2018

Legend
— Quantity

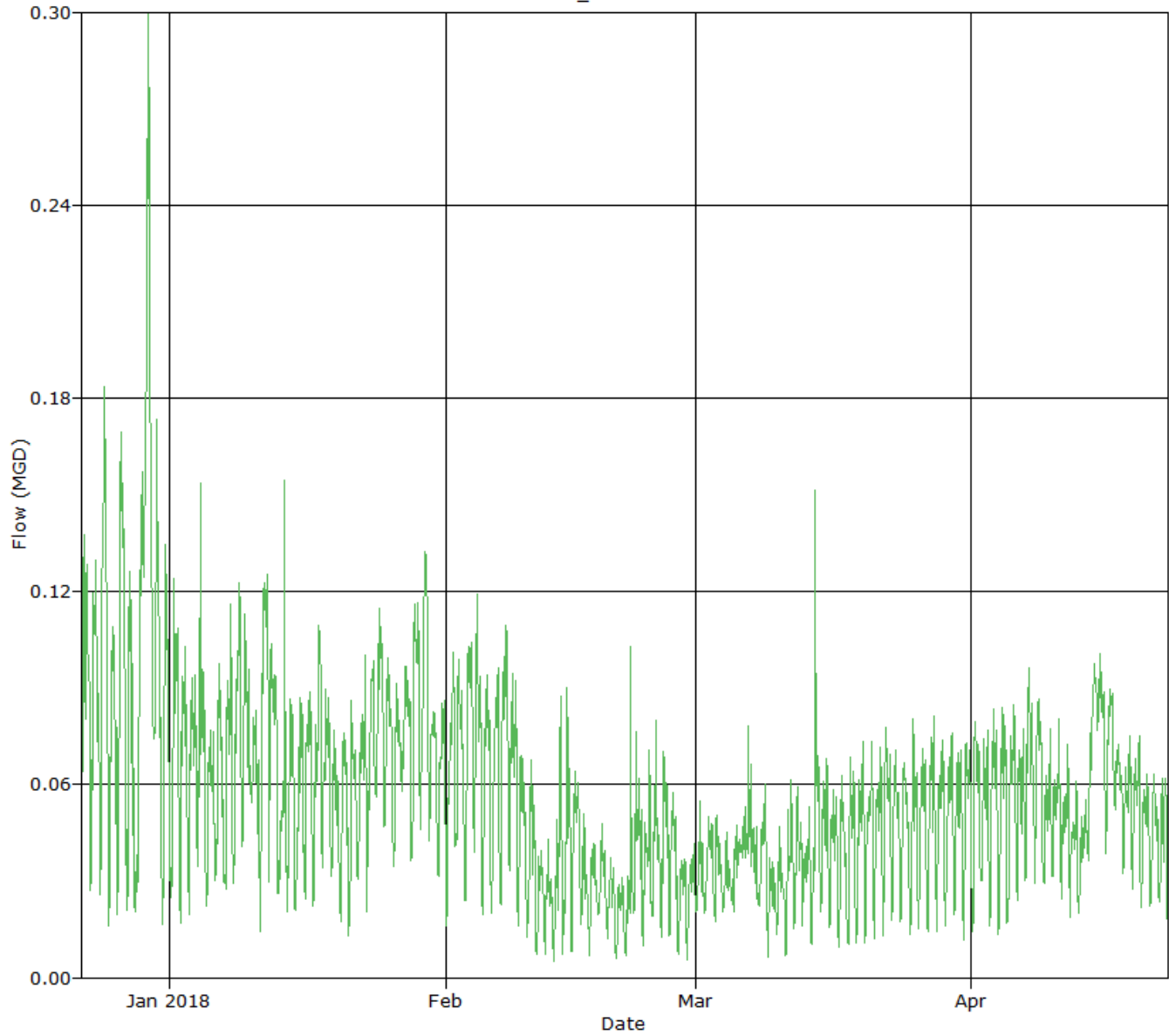

SCATTERGRAPH REPORT

REN_MH6041

Flow Monitor
REN_MH6041

Pipe Height
8.00 in

Report Period
12/22/2017
To
4/22/2018

Legend
○ Depth - Velocity
- - Iso-Q™
- - Silt
▼ Min-Max Depth

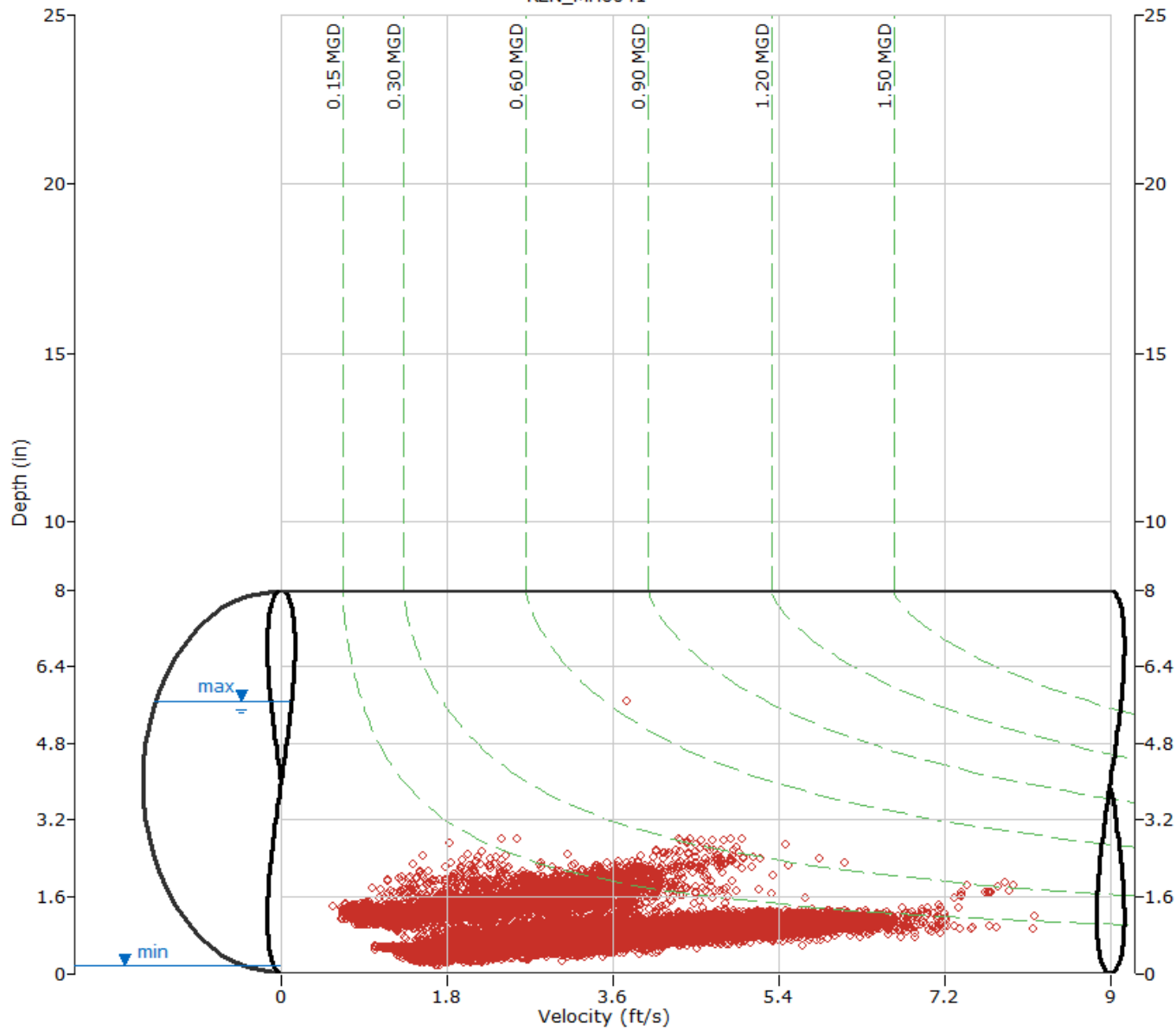

ADS Environmental Services

Pipe Height: 8.00

Date	REN_MH6041\mp1\DFINAL (inches)					REN_MH6041\mp1\VFINAL (feet/sec)					REN_MH6041\mp1\QFINAL (MGD - Total MG)					
	Time	Min.	Time	Max.	Average	Time	Min.	Time	Max.	Average	Time	Min.	Time	Max.	Average	Total
12/22/2017	1:35	1.5	13:30	2.8	1.8	14:05	1.3	19:15	4.5	2.5	1:35	0.040	7:05	0.176	0.097	0.097
12/23/2017	1:45	1.2	21:15	2.1	1.6	2:55	0.7	11:15	4.9	2.6	2:55	0.017	21:15	0.194	0.086	0.086
12/24/2017	4:55	1.3	17:00	2.3	1.7	6:20	0.6	16:20	5.3	2.9	6:20	0.015	16:20	0.243	0.110	0.110
12/25/2017	4:25	1.1	8:00	1.9	1.5	5:05	0.7	10:55	4.8	2.4	5:05	0.012	15:35	0.138	0.071	0.071
12/26/2017	3:25	1.1	12:30	2.2	1.7	1:30	0.7	14:25	4.1	2.7	1:30	0.014	12:35	0.198	0.103	0.103
12/27/2017	4:55	0.9	18:20	2.8	1.5	8:35	0.9	9:00	4.1	2.2	4:55	0.016	13:15	0.185	0.066	0.066
12/28/2017	2:20	1.1	15:00	2.5	1.5	1:50	0.7	20:55	3.9	2.3	1:50	0.014	15:00	0.185	0.077	0.077
12/29/2017	22:55	1.6	15:00	2.8	2.1	22:50	2.9	12:10	6.1	4.0	22:55	0.098	15:45	0.349	0.189	0.189
12/30/2017	20:55	1.3	13:30	2.7	1.6	3:15	1.9	13:30	5.5	3.1	3:15	0.055	13:30	0.362	0.105	0.105
12/31/2017	4:50	1.0	13:05	2.2	1.4	3:00	0.8	12:25	4.4	2.4	5:30	0.013	13:05	0.198	0.072	0.072
ReportAvg	1.6					2.7					0.097					
ReportTotal											0.973					

ADS Environmental Services

Pipe Height: 8.00

Date	REN_MH6041\mp1\DFINAL (inches)					REN_MH6041\mp1\VFINAL (feet/sec)					REN_MH6041\mp1\QFINAL (MGD - Total MG)					
	Time	Min.	Time	Max.	Average	Time	Min.	Time	Max.	Average	Time	Min.	Time	Max.	Average	Total
1/1/2018	3:50	1.2	18:00	2.2	1.5	3:35	0.7	9:00	4.3	2.2	3:35	0.016	16:55	0.195	0.073	0.073
1/2/2018	3:30	1.0	6:50	2.2	1.4	4:35	0.8	6:50	5.5	2.5	4:35	0.015	6:50	0.286	0.067	0.067
1/3/2018	3:05	1.0	6:40	1.8	1.3	4:50	0.8	12:00	5.2	2.7	4:50	0.015	12:00	0.189	0.065	0.065
1/4/2018	12:30	0.7	10:30	5.7	1.2	3:10	0.9	19:55	6.5	3.4	3:10	0.020	10:30	0.640	0.069	0.069
1/5/2018	5:15	0.6	20:50	1.1	0.9	3:15	1.8	13:20	6.3	3.7	4:15	0.017	13:20	0.120	0.054	0.054
1/6/2018	1:35	0.7	11:15	1.2	0.9	3:20	2.3	18:25	6.8	4.0	1:40	0.024	11:15	0.147	0.061	0.061
1/7/2018	7:30	0.7	22:20	1.3	1.0	5:30	2.1	10:50	6.3	4.1	5:30	0.022	10:50	0.153	0.066	0.066
1/8/2018	4:55	0.7	21:20	1.3	1.0	3:50	2.3	20:40	6.6	4.3	3:50	0.026	20:40	0.150	0.077	0.077
1/9/2018	3:00	0.7	17:50	1.4	1.0	4:05	2.6	18:30	6.4	4.5	3:00	0.029	11:10	0.143	0.075	0.075
1/10/2018	20:50	0.7	16:00	1.5	1.0	3:05	2.4	22:40	6.3	4.0	20:00	0.035	11:15	0.118	0.066	0.066
1/11/2018	2:40	0.5	22:00	1.3	1.0	2:55	2.0	9:15	6.7	5.1	2:40	0.011	22:00	0.140	0.087	0.087
1/12/2018	4:45	0.6	0:10	1.3	1.0	4:45	2.4	7:25	6.8	4.8	4:45	0.017	7:25	0.136	0.085	0.085
1/13/2018	7:20	0.6	20:40	1.7	0.9	4:40	2.3	20:50	7.7	3.7	5:40	0.021	20:40	0.269	0.056	0.056
1/14/2018	4:25	0.5	18:45	1.3	0.9	6:00	2.4	18:45	6.9	4.1	5:00	0.017	18:45	0.158	0.058	0.058
1/15/2018	5:25	0.5	22:35	1.2	0.9	3:55	2.6	16:20	6.4	3.9	1:15	0.017	22:35	0.129	0.055	0.055
1/16/2018	5:15	0.6	11:10	1.2	0.9	4:40	2.2	12:05	6.3	4.2	5:15	0.018	18:05	0.115	0.063	0.063
1/17/2018	4:25	0.5	21:35	1.2	0.9	2:50	2.5	18:35	6.8	4.4	4:25	0.017	21:35	0.144	0.066	0.066
1/18/2018	4:10	0.7	12:35	1.1	0.9	1:30	2.6	19:55	7.1	4.8	4:35	0.028	20:35	0.120	0.063	0.063
1/19/2018	6:05	0.5	14:00	1.2	0.8	4:05	2.8	10:20	7.4	4.4	4:35	0.017	14:00	0.138	0.054	0.054
1/20/2018	6:30	0.4	15:05	1.0	0.8	1:50	2.2	20:05	6.6	4.1	4:10	0.012	9:45	0.103	0.050	0.050
1/21/2018	4:30	0.3	21:45	1.2	0.8	5:30	2.0	15:00	6.7	4.1	4:30	0.007	13:30	0.101	0.051	0.051
1/22/2018	1:30	0.6	23:50	1.7	0.9	3:15	2.6	10:10	6.4	4.3	1:30	0.019	23:40	0.130	0.061	0.061
1/23/2018	3:50	0.4	0:30	1.5	0.9	3:00	2.3	21:20	6.8	4.7	3:50	0.012	21:20	0.153	0.069	0.069
1/24/2018	0:10	0.7	12:10	1.2	1.0	4:15	3.5	17:25	7.1	5.2	4:45	0.046	12:10	0.153	0.087	0.087
1/25/2018	4:00	0.6	10:45	1.1	1.0	23:20	3.1	18:50	6.6	4.9	4:00	0.026	8:15	0.118	0.076	0.076
1/26/2018	1:45	0.6	18:50	1.1	0.9	2:30	2.7	8:50	6.7	4.7	1:45	0.028	18:50	0.121	0.067	0.067
1/27/2018	4:25	0.7	15:15	1.1	0.9	0:20	3.9	11:50	6.9	5.3	4:25	0.044	15:15	0.115	0.081	0.081
1/28/2018	2:00	0.6	20:50	1.3	1.0	4:05	3.0	10:20	7.2	4.8	3:05	0.030	10:20	0.162	0.083	0.083
1/29/2018	4:00	0.7	13:55	1.3	1.1	4:10	2.8	19:55	8.2	5.0	4:00	0.027	19:55	0.170	0.091	0.091
1/30/2018	2:55	0.7	11:20	1.0	0.9	3:15	3.3	15:20	6.5	5.1	3:15	0.029	11:30	0.104	0.070	0.070
1/31/2018	2:35	0.5	14:00	1.3	0.8	2:05	2.9	19:50	7.5	4.7	2:35	0.020	14:00	0.159	0.061	0.061
ReportAvg	1.0					4.2					0.068					
ReportTotal											2.107					

ADS Environmental Services

Pipe Height: 8.00

Date	REN_MH6041\mp1\DFINAL (inches)					REN_MH6041\mp1\VFINAL (feet/sec)					REN_MH6041\mp1\QFINAL (MGD - Total MG)					
	Time	Min.	Time	Max.	Average	Time	Min.	Time	Max.	Average	Time	Min.	Time	Max.	Average	Total
2/1/2018	2:45	0.4	21:40	1.1	0.8	2:55	2.4	14:15	7.2	4.7	2:45	0.012	21:40	0.116	0.063	0.063
2/2/2018	5:50	0.6	9:50	1.2	0.9	1:40	3.1	6:35	6.6	4.8	5:50	0.030	19:20	0.119	0.072	0.072
2/3/2018	6:15	0.4	21:30	1.3	1.0	2:50	2.7	12:10	7.2	4.6	6:15	0.013	20:05	0.147	0.074	0.074
2/4/2018	5:10	0.6	13:20	1.3	1.0	3:55	2.5	11:35	6.7	4.5	5:10	0.022	11:35	0.141	0.077	0.077
2/5/2018	4:55	0.5	14:35	1.1	0.9	2:05	2.3	12:40	7.0	4.4	4:10	0.015	12:40	0.114	0.063	0.063
2/6/2018	5:05	0.4	21:10	1.2	0.9	2:05	2.5	16:00	7.2	4.4	5:05	0.010	21:10	0.145	0.063	0.063
2/7/2018	5:20	0.3	19:35	1.3	1.0	2:35	2.0	13:45	6.8	4.3	5:20	0.012	20:40	0.141	0.072	0.072
2/8/2018	23:10	0.5	9:35	1.2	0.9	3:05	2.0	20:55	6.3	4.2	3:05	0.012	9:35	0.116	0.065	0.065
2/9/2018	22:05	0.3	14:50	1.0	0.8	22:05	1.9	17:40	7.0	4.0	22:05	0.005	13:15	0.104	0.047	0.047
2/10/2018	4:10	0.3	21:45	1.0	0.7	3:30	1.7	9:20	7.1	3.8	4:10	0.005	15:00	0.103	0.040	0.040
2/11/2018	5:40	0.2	20:30	0.9	0.6	6:00	1.4	7:50	5.9	3.0	5:40	0.003	7:50	0.084	0.026	0.026
2/12/2018	1:45	0.3	20:05	1.0	0.6	4:10	1.3	12:40	6.4	2.8	1:45	0.004	20:05	0.089	0.024	0.024
2/13/2018	1:45	0.2	17:35	1.1	0.7	3:35	1.3	17:35	6.5	3.2	1:45	0.003	17:35	0.129	0.036	0.036
2/14/2018	3:15	0.3	14:20	1.2	0.7	4:05	1.3	14:20	7.0	3.5	3:15	0.003	14:20	0.148	0.042	0.042
2/15/2018	4:05	0.2	16:35	1.0	0.8	1:40	1.2	21:30	6.0	3.7	1:45	0.003	21:30	0.096	0.043	0.043
2/16/2018	6:05	0.3	13:40	0.9	0.7	22:20	1.7	12:10	5.8	3.1	6:05	0.006	13:40	0.075	0.030	0.030
2/17/2018	1:55	0.2	11:15	1.0	0.7	2:40	1.4	11:15	5.9	2.8	1:55	0.002	11:15	0.091	0.027	0.027
2/18/2018	23:55	0.4	13:25	1.0	0.7	3:00	1.6	13:25	5.9	3.0	23:55	0.012	13:25	0.094	0.031	0.031
2/19/2018	23:20	0.3	18:30	1.0	0.7	23:50	1.4	13:10	5.7	2.8	23:20	0.004	18:30	0.090	0.026	0.026
2/20/2018	6:00	0.2	20:00	1.0	0.6	1:25	1.1	19:40	5.3	2.4	6:00	0.003	20:00	0.070	0.020	0.020
2/21/2018	4:00	0.3	17:35	1.4	0.6	3:10	1.0	17:35	7.2	2.8	4:00	0.004	17:35	0.183	0.029	0.029
2/22/2018	22:30	0.3	7:20	1.7	0.7	22:30	1.9	7:20	7.9	3.5	22:30	0.005	7:20	0.279	0.040	0.040
2/23/2018	1:30	0.2	20:15	1.1	0.7	4:55	1.6	20:00	5.6	3.4	1:30	0.004	20:00	0.091	0.036	0.036
2/24/2018	12:25	0.5	14:00	1.0	0.8	5:15	1.7	14:00	6.2	3.6	5:05	0.015	14:00	0.108	0.040	0.040
2/25/2018	5:45	0.3	12:10	1.0	0.7	3:45	1.3	11:00	6.7	3.8	5:45	0.005	18:15	0.094	0.042	0.042
2/26/2018	23:15	0.3	18:20	1.0	0.7	4:00	2.0	18:20	5.5	3.7	23:15	0.005	18:20	0.088	0.036	0.036
2/27/2018	4:25	0.2	13:00	0.9	0.6	3:20	1.4	18:55	5.4	3.0	3:50	0.004	13:00	0.074	0.026	0.026
2/28/2018	1:45	0.2	5:55	1.0	0.6	2:15	1.5	9:15	5.4	3.2	5:00	0.003	19:45	0.090	0.028	0.028
ReportAvg	0.8					3.6					0.043					
ReportTotal											1.218					

ADS Environmental Services

Pipe Height: 8.00

Date	REN_MH6041\mp1\DFINAL (inches)					REN_MH6041\mp1\VFINAL (feet/sec)					REN_MH6041\mp1\QFINAL (MGD - Total MG)					
	Time	Min.	Time	Max.	Average	Time	Min.	Time	Max.	Average	Time	Min.	Time	Max.	Average	Total
3/1/2018	23:00	0.4	12:40	1.0	0.7	3:25	2.6	12:35	5.7	3.5	23:00	0.013	12:40	0.096	0.033	0.033
3/2/2018	3:05	0.4	18:10	1.0	0.7	1:15	2.8	13:15	6.2	3.7	5:00	0.016	18:10	0.091	0.037	0.037
3/3/2018	1:25	0.4	8:35	1.2	0.7	5:50	2.3	8:50	5.4	3.4	1:25	0.015	8:50	0.095	0.034	0.034
3/4/2018	17:45	0.4	21:10	1.1	0.7	6:05	2.1	11:45	5.8	3.1	17:45	0.014	12:55	0.085	0.030	0.030
3/5/2018	6:55	0.4	16:55	1.4	0.8	3:10	1.5	13:45	6.2	2.9	6:55	0.011	13:45	0.107	0.034	0.034
3/6/2018	17:00	0.4	23:15	1.6	0.9	23:50	2.1	10:15	5.8	3.3	17:00	0.014	23:40	0.095	0.044	0.044
3/7/2018	17:25	0.4	0:00	1.6	0.9	4:50	1.7	21:45	5.8	3.3	23:50	0.015	5:35	0.104	0.042	0.042
3/8/2018	7:20	0.4	20:30	1.1	0.7	2:00	2.7	20:30	5.9	3.7	7:20	0.012	20:30	0.107	0.040	0.040
3/9/2018	4:50	0.3	18:20	1.0	0.6	3:25	1.2	18:20	5.9	3.0	4:50	0.004	18:20	0.096	0.026	0.026
3/10/2018	7:15	0.3	11:00	1.0	0.7	16:35	2.1	9:20	5.9	3.1	7:15	0.005	11:00	0.089	0.028	0.028
3/11/2018	1:15	0.2	18:20	1.1	0.7	5:25	1.4	18:40	6.4	3.0	1:15	0.003	18:40	0.114	0.033	0.033
3/12/2018	3:15	0.3	20:25	1.1	0.8	23:50	1.5	10:45	6.1	3.2	3:15	0.004	10:45	0.109	0.037	0.037
3/13/2018	0:25	0.3	0:50	1.2	0.8	1:20	1.1	18:45	6.0	3.0	0:20	0.005	18:45	0.080	0.034	0.034
3/14/2018	0:10	0.3	10:30	1.9	0.8	2:40	1.9	10:40	7.9	3.8	0:05	0.007	10:30	0.319	0.054	0.054
3/15/2018	15:55	0.4	17:30	1.1	0.8	3:05	1.6	17:30	5.6	3.6	15:55	0.013	17:30	0.099	0.046	0.046
3/16/2018	2:15	0.4	18:50	0.9	0.8	3:10	1.7	16:55	6.2	3.6	2:15	0.009	16:55	0.085	0.041	0.041
3/17/2018	5:25	0.4	8:15	1.0	0.7	3:50	1.4	8:15	6.6	3.6	5:25	0.008	8:15	0.109	0.037	0.037
3/18/2018	1:35	0.3	13:15	1.0	0.7	3:05	1.6	7:25	7.2	3.6	1:55	0.008	7:25	0.092	0.041	0.041
3/19/2018	4:25	0.3	18:55	1.1	0.8	2:10	1.5	17:30	6.9	3.7	0:00	0.007	22:10	0.094	0.043	0.043
3/20/2018	0:20	0.4	15:20	1.0	0.8	2:20	1.4	20:15	6.3	3.6	0:20	0.007	20:15	0.101	0.044	0.044
3/21/2018	3:20	0.4	20:55	1.1	0.8	1:45	1.7	18:55	6.7	3.8	2:05	0.008	18:55	0.106	0.046	0.046
3/22/2018	3:40	0.4	8:10	1.1	0.8	3:15	1.6	8:10	6.0	3.9	0:50	0.010	8:10	0.106	0.050	0.050
3/23/2018	1:05	0.3	6:35	1.0	0.8	3:30	1.5	12:15	6.4	3.9	1:05	0.007	12:15	0.106	0.047	0.047
3/24/2018	1:15	0.3	10:05	1.1	0.8	1:30	1.9	9:25	6.0	3.9	1:15	0.007	10:05	0.105	0.046	0.046
3/25/2018	3:55	0.4	11:05	1.0	0.8	5:25	1.9	10:35	7.1	3.9	2:30	0.009	10:40	0.105	0.047	0.047
3/26/2018	2:20	0.4	19:15	1.0	0.8	2:40	1.9	12:50	6.7	4.0	1:10	0.009	12:50	0.105	0.048	0.048
3/27/2018	1:05	0.3	17:50	1.1	0.8	1:35	1.6	14:55	6.6	3.8	1:05	0.006	19:45	0.107	0.052	0.052
3/28/2018	0:45	0.4	15:10	1.1	0.8	2:20	1.6	20:45	6.1	3.8	2:25	0.008	20:45	0.105	0.050	0.050
3/29/2018	0:55	0.5	20:35	1.2	0.8	1:35	1.5	18:55	6.2	3.7	1:35	0.010	18:55	0.127	0.050	0.050
3/30/2018	2:30	0.4	17:25	1.2	0.9	3:20	1.5	17:25	6.2	3.6	2:10	0.008	17:25	0.126	0.050	0.050
3/31/2018	2:30	0.4	19:55	1.2	0.9	1:40	1.6	7:25	6.8	3.6	2:30	0.007	7:25	0.106	0.051	0.051
ReportAvg	0.8					3.5					0.042					
ReportTotal											1.294					

ADS Environmental Services

Pipe Height: 8.00

Date	REN_MH6041\mp1\DFINAL (inches)					REN_MH6041\mp1\VFINAL (feet/sec)					REN_MH6041\mp1\QFINAL (MGD - Total MG)					
	Time	Min.	Time	Max.	Average	Time	Min.	Time	Max.	Average	Time	Min.	Time	Max.	Average	Total
4/1/2018	1:10	0.4	19:20	1.1	0.9	4:05	1.4	9:30	6.7	3.8	1:10	0.009	18:10	0.114	0.052	0.052
4/2/2018	23:50	0.5	19:20	1.1	0.9	0:20	2.6	8:10	5.8	3.8	23:50	0.020	20:05	0.100	0.052	0.052
4/3/2018	1:40	0.4	18:55	1.1	0.9	2:00	1.4	11:45	6.8	3.8	1:40	0.006	11:45	0.124	0.055	0.055
4/4/2018	1:25	0.5	21:10	1.1	0.9	1:20	1.5	19:30	6.3	3.9	2:15	0.010	21:10	0.117	0.056	0.056
4/5/2018	2:30	0.4	19:15	1.1	0.9	2:40	1.6	9:00	5.9	3.9	1:55	0.008	19:15	0.114	0.056	0.056
4/6/2018	3:45	0.4	20:10	1.1	0.9	3:45	2.0	20:40	6.6	3.7	3:45	0.009	20:40	0.121	0.053	0.053
4/7/2018	1:30	0.4	12:55	1.2	1.0	1:30	2.0	19:30	7.2	4.2	1:30	0.010	19:30	0.143	0.067	0.067
4/8/2018	1:45	0.6	19:25	1.1	0.9	2:25	2.9	12:30	7.3	4.4	1:45	0.021	12:30	0.117	0.064	0.064
4/9/2018	3:35	0.4	21:05	1.1	0.8	2:35	2.7	9:50	7.1	3.9	3:35	0.016	21:05	0.115	0.051	0.051
4/10/2018	5:50	0.5	7:10	1.1	0.9	2:00	2.2	21:35	5.7	3.7	5:50	0.018	20:50	0.107	0.051	0.051
4/11/2018	2:25	0.4	17:00	1.0	0.8	2:25	1.7	20:00	5.7	3.7	2:25	0.006	20:00	0.094	0.047	0.047
4/12/2018	2:25	0.3	19:05	0.9	0.8	4:00	2.6	20:40	6.9	3.7	2:25	0.010	19:30	0.090	0.041	0.041
4/13/2018	0:45	0.4	9:30	0.9	0.7	2:50	2.5	21:20	6.1	3.7	1:35	0.011	21:20	0.075	0.040	0.040
4/14/2018	4:00	0.6	21:10	1.1	0.9	4:00	2.9	14:25	6.4	4.8	4:00	0.021	21:10	0.112	0.072	0.072
4/15/2018	18:55	0.7	20:15	1.1	1.0	23:25	3.8	19:05	7.8	5.4	23:35	0.053	10:40	0.119	0.085	0.085
4/16/2018	2:15	0.6	9:20	1.0	0.9	4:20	3.3	18:15	8.2	5.0	2:15	0.029	17:35	0.122	0.073	0.073
4/17/2018	22:50	0.6	6:40	1.0	0.9	23:55	3.1	13:15	6.0	4.6	22:50	0.032	12:05	0.092	0.062	0.062
4/18/2018	2:25	0.4	19:35	1.0	0.8	2:50	3.1	17:05	6.3	4.4	2:25	0.012	9:45	0.090	0.054	0.054
4/19/2018	0:55	0.3	11:15	1.0	0.8	1:00	2.9	16:25	6.8	4.1	0:55	0.006	16:25	0.108	0.054	0.054
4/20/2018	0:05	0.4	5:35	1.0	0.8	2:15	2.7	10:30	5.8	3.9	0:05	0.012	10:30	0.092	0.047	0.047
4/21/2018	4:50	0.3	14:35	1.0	0.8	2:30	2.2	7:50	6.3	3.7	4:50	0.010	14:35	0.099	0.045	0.045
4/22/2018	23:15	0.4	17:10	1.1	0.8	2:15	1.8	12:05	5.9	3.7	23:15	0.011	17:10	0.110	0.043	0.043
ReportAvg	0.9					4.1					0.055					
ReportTotal											1.221					

REN_MH6704

Located At: 2623 NE Sunset Blvd (see attached site report for details)
Monitoring Period: December 22, 2017 – April 22, 2018
Pipe Dimensions: 12"
Finalized Silt Level: 0 mm

Site Data Characteristics: This site is located in a sanitary sewer pipe. The scattergraph indicates site operated in free flow conditions. The site did not surcharge during the monitoring period. The dry weather data plots above the Froude =1 curve indicating supercritical flow.

Site Data Bias & Editing: The depth and velocity measurements recorded by the flow monitor were consistent with field confirmations conducted to date and supported the relative accuracy of the flow monitor at this location. The finalized depth data utilized the downward ultrasonic sensor.

Site Data Uptime: The data uptime achieved during the monitoring period is provided in the table below. Based upon the quality and consistency of the observed flow depth and velocity data, the Continuity equation was used to calculate the flow rate for the monitoring period.

Entity	Percentage Uptime Raw	Percentage Uptime Final
Depth (in)	100%	100%
Velocity (f/s)	100%	100%
Quantity (mgd)	100%	100%

Site Data Summary: The average flow depth, velocity, and quantity data observed during the monitoring period along with observed minimum and maximum data, are provided in the following table. The minimum and maximum rates recorded in the tables are based on 5-minute data intervals.

Item	Depth (in)	Velocity (f/s)	Quantity (mgd)	% Full
Minimum	0.53	3.62	0.035	4%
Maximum	1.74	9.94	0.441	15%
Average	1.02	6.14	0.132	9%

Additional Photos

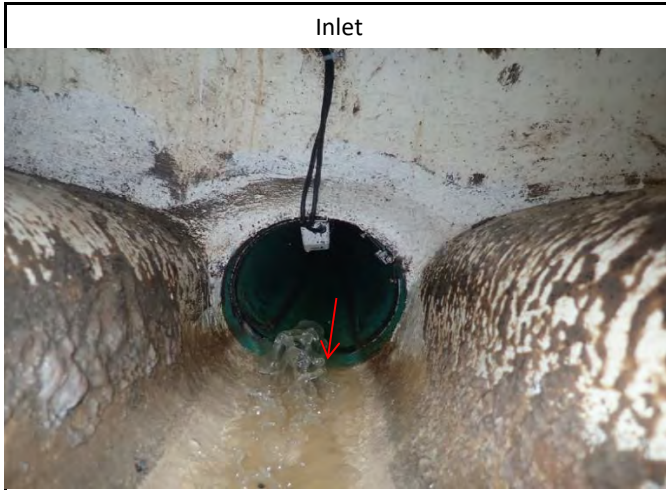

Inlet

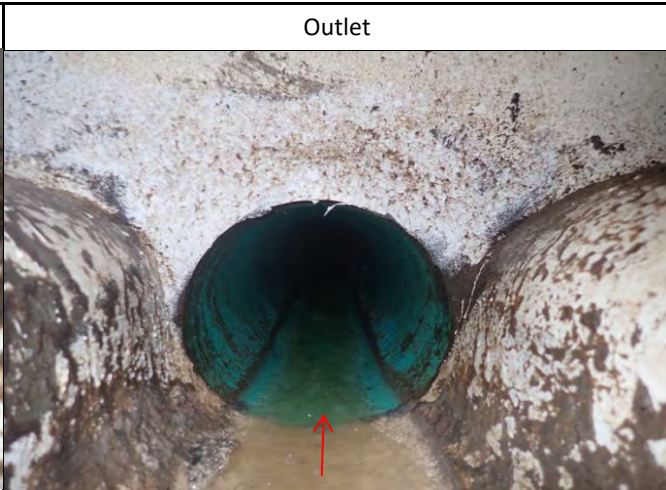

Outlet



Location Map

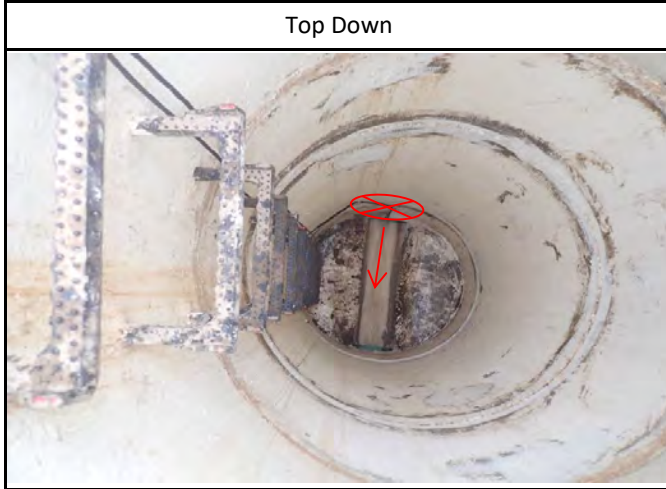

Top Down



Location



Location Map

KEY

- Flow Direction
- ⊖ Monitoring Point

HYDROGRAPH REPORT

REN_MH6704

Flow Monitor
REN_MH6704

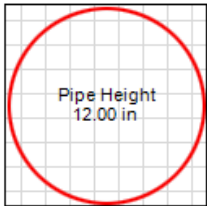

Report Period
12/22/2017
To
4/22/2018

Legend
— Depth
— Velocity
— Rain

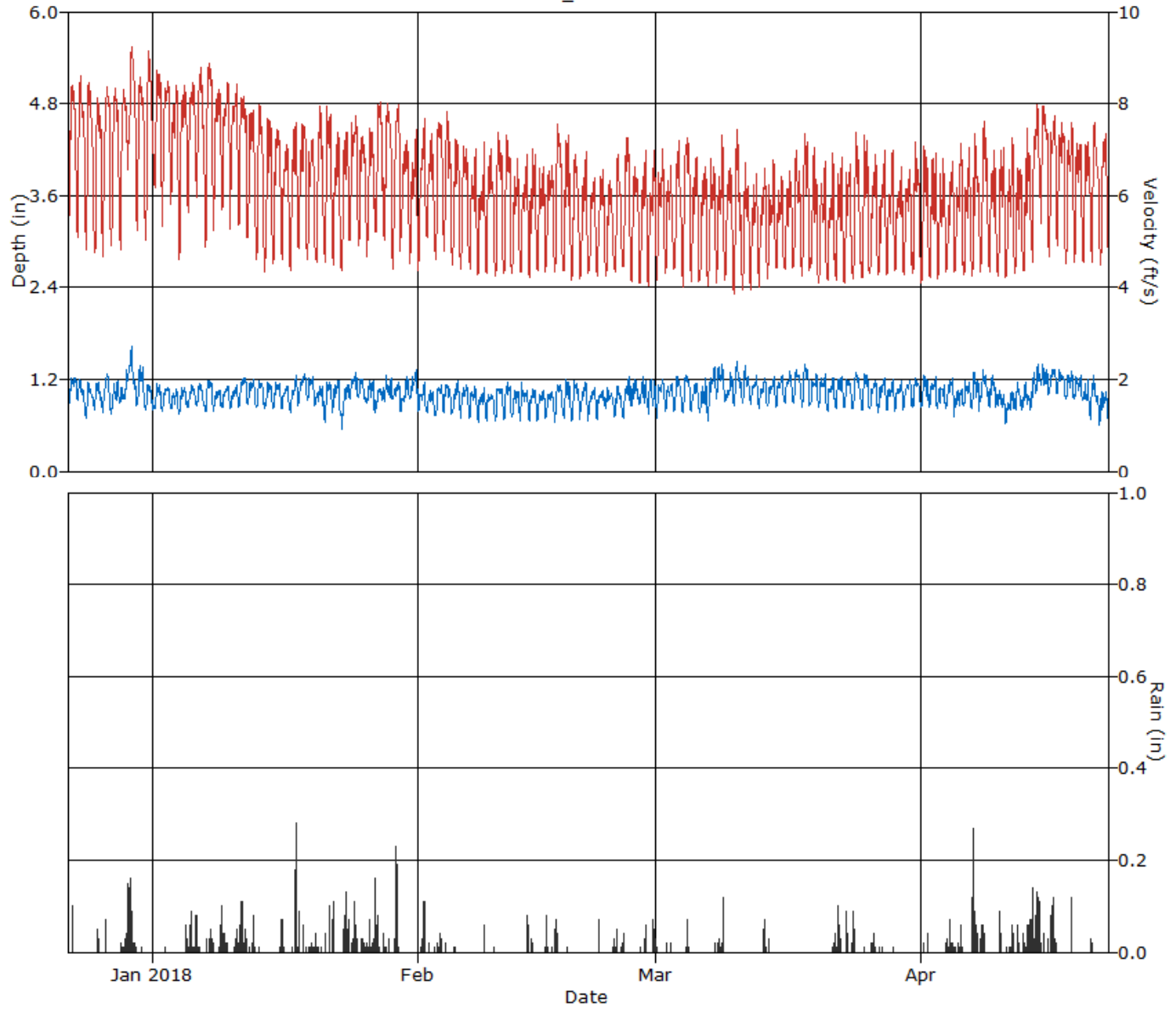

HYDROGRAPH REPORT

REN_MH6704

Flow Monitor
REN_MH6704

Pipe Height
12.00 in.

Report Period
12/22/2017
To
4/22/2018

Legend
— Quantity
— Rain

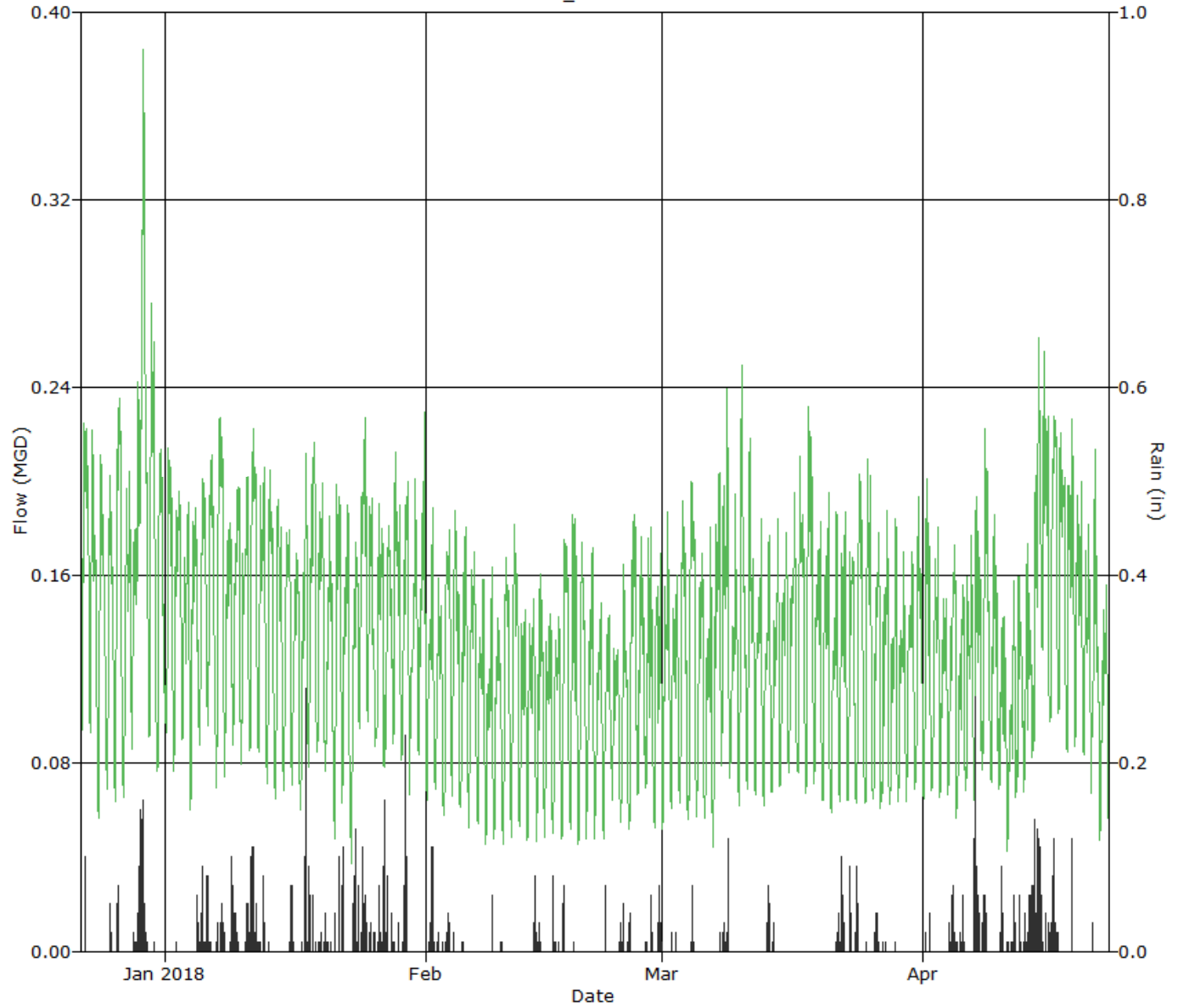

SCATTERGRAPH REPORT

REN_MH6704

Flow Monitor
REN_MH6704

Pipe Height
12.00 in

Report Period
12/22/2017
To
4/22/2018

Legend
○ Depth - Velocity
--- Iso-Q™
--- Silt
▼ Min-Max Depth

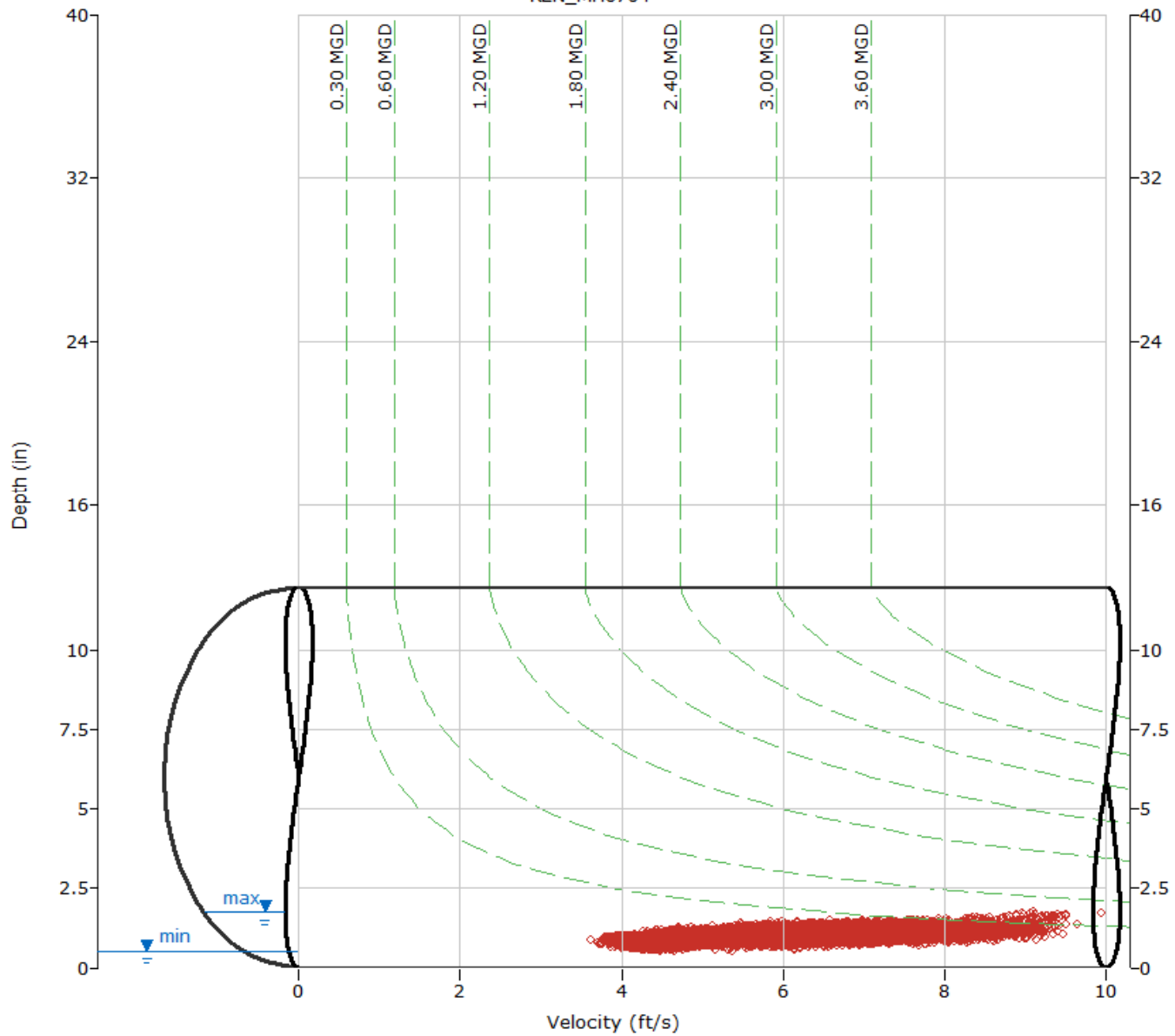

ADS Environmental Services

Pipe Height: 12.00

Date	REN_MH6704\mp1\DFINAL (inches)					REN_MH6704\mp1\VFINAL (feet/sec)					REN_MH6704\mp1\QFINAL (MGD - Total MG)					REN_RG\mp1\RAIN (inches)	
	Time	Min.	Time	Max.	Average	Time	Min.	Time	Max.	Average	Time	Min.	Time	Max.	Average	Total	Total
12/22/2017	1:20	0.8	11:55	1.3	1.1	3:25	5.1	11:55	9.2	7.3	2:50	0.082	11:55	0.287	0.172	0.172	0.10
12/23/2017	23:25	0.8	10:25	1.3	1.0	5:45	4.5	10:40	8.9	7.2	3:10	0.079	10:25	0.255	0.159	0.159	0.00
12/24/2017	4:15	0.6	9:05	1.2	1.0	3:35	4.5	10:40	9.2	7.1	4:30	0.047	10:40	0.252	0.141	0.141	0.00
12/25/2017	3:50	0.8	11:10	1.3	1.0	6:05	4.4	15:15	8.8	6.7	4:00	0.063	12:35	0.244	0.137	0.137	0.14
12/26/2017	23:15	0.7	16:45	1.4	1.0	3:40	4.3	15:15	8.8	7.1	3:35	0.055	16:10	0.276	0.160	0.160	0.17
12/27/2017	3:25	0.7	20:25	1.3	1.0	1:20	4.4	15:55	8.7	7.0	1:20	0.053	11:35	0.250	0.142	0.142	0.00
12/28/2017	2:50	0.7	21:30	1.5	1.0	4:50	4.3	13:40	8.8	7.1	2:50	0.067	21:35	0.280	0.154	0.154	0.25
12/29/2017	23:10	0.9	12:50	1.7	1.3	2:45	6.2	12:00	9.9	8.2	23:10	0.126	12:00	0.441	0.247	0.247	1.57
12/30/2017	2:15	0.8	12:25	1.5	1.1	2:30	4.9	12:15	9.0	7.4	2:30	0.081	11:00	0.310	0.182	0.182	0.02
12/31/2017	20:50	0.7	15:00	1.3	1.0	5:05	4.7	13:05	9.5	7.5	5:05	0.068	15:00	0.270	0.150	0.150	0.00
ReportAvg	1.1					7.3					0.164						
ReportTotal																1.645	2.25

ADS Environmental Services

Pipe Height: 12.00

Date	REN_MH6704\mp1\DFINAL (inches)					REN_MH6704\mp1\VFINAL (feet/sec)					REN_MH6704\mp1\QFINAL (MGD - Total MG)					REN_RG\mp1\RAIN (inches)	
	Time	Min.	Time	Max.	Average	Time	Min.	Time	Max.	Average	Time	Min.	Time	Max.	Average	Total	Total
1/1/2018	0:40	0.7	18:25	1.2	1.0	4:55	5.6	18:20	9.2	7.7	0:40	0.073	18:20	0.237	0.153	0.153	0.00
1/2/2018	2:45	0.7	18:40	1.2	1.0	3:30	4.8	15:25	9.1	7.5	1:40	0.067	18:40	0.226	0.151	0.151	0.01
1/3/2018	4:40	0.8	19:00	1.3	0.9	2:55	5.0	19:00	9.3	7.4	2:55	0.073	19:00	0.290	0.139	0.139	0.00
1/4/2018	2:25	0.7	12:40	1.2	0.9	2:25	4.3	12:40	8.9	7.1	2:25	0.050	12:40	0.242	0.138	0.138	0.09
1/5/2018	23:35	0.8	12:35	1.2	1.0	2:05	4.9	17:05	9.4	7.4	2:05	0.077	12:55	0.230	0.150	0.150	0.42
1/6/2018	23:05	0.8	15:05	1.2	1.0	3:05	5.3	15:05	9.2	7.6	3:00	0.085	15:05	0.242	0.155	0.155	0.24
1/7/2018	6:00	0.7	13:45	1.4	1.0	3:20	4.5	18:30	9.7	7.5	6:00	0.060	18:30	0.301	0.162	0.162	0.38
1/8/2018	2:05	0.8	16:55	1.2	1.0	2:30	4.6	14:20	9.0	7.3	2:40	0.062	16:55	0.235	0.141	0.141	0.14
1/9/2018	4:05	0.8	20:15	1.2	1.0	3:30	4.9	20:15	9.0	7.4	3:30	0.072	20:15	0.236	0.151	0.151	0.46
1/10/2018	0:15	0.8	12:25	1.3	1.0	1:20	4.6	13:25	9.1	7.3	1:20	0.065	12:25	0.267	0.146	0.146	0.22
1/11/2018	3:35	0.8	14:40	1.4	1.1	3:55	4.7	14:40	9.0	7.2	3:55	0.075	14:40	0.314	0.167	0.167	1.04
1/12/2018	5:35	0.8	10:30	1.3	1.0	4:20	4.7	10:30	8.7	6.8	4:20	0.076	10:30	0.269	0.149	0.149	0.20
1/13/2018	4:05	0.8	12:35	1.2	1.0	4:25	4.2	11:40	8.5	6.5	4:25	0.063	11:50	0.223	0.141	0.141	0.02
1/14/2018	3:30	0.8	14:00	1.3	1.0	3:15	4.2	19:00	8.7	6.3	3:50	0.060	14:00	0.247	0.133	0.133	0.00
1/15/2018	3:30	0.8	11:05	1.2	1.0	3:45	4.3	17:00	8.1	6.4	3:30	0.060	12:40	0.199	0.135	0.135	0.04
1/16/2018	5:10	0.8	18:25	1.2	1.0	0:40	4.3	12:40	8.2	6.1	3:40	0.064	18:25	0.209	0.123	0.123	0.26
1/17/2018	2:50	0.7	18:10	1.3	1.0	1:45	4.2	15:40	8.2	6.2	2:50	0.055	20:50	0.232	0.132	0.132	0.79
1/18/2018	1:25	0.8	15:30	1.3	1.1	1:50	4.4	15:15	8.9	6.5	1:25	0.068	15:15	0.264	0.157	0.157	0.40
1/19/2018	23:15	0.7	17:30	1.3	1.1	1:55	4.3	18:00	8.2	6.1	23:15	0.063	18:00	0.223	0.143	0.143	0.10
1/20/2018	2:15	0.7	21:20	1.2	1.0	5:40	4.3	13:15	8.4	6.4	2:15	0.059	13:35	0.221	0.128	0.128	0.10
1/21/2018	4:20	0.6	11:25	1.2	1.0	5:50	4.3	18:10	9.0	6.4	4:20	0.044	18:10	0.235	0.131	0.131	0.16
1/22/2018	23:55	0.6	19:05	1.3	1.0	3:15	4.3	16:50	8.6	6.1	23:55	0.047	16:50	0.234	0.129	0.129	0.34
1/23/2018	3:50	0.5	18:40	1.4	0.9	1:20	4.2	12:20	8.9	6.2	3:55	0.035	18:40	0.268	0.116	0.116	0.79
1/24/2018	23:50	0.8	22:05	1.4	1.1	4:35	4.7	12:45	8.5	6.7	1:45	0.077	12:45	0.269	0.168	0.168	0.51
1/25/2018	23:10	0.8	20:05	1.3	1.1	2:30	4.7	17:25	8.0	6.4	23:20	0.083	16:50	0.224	0.144	0.144	0.14
1/26/2018	23:55	0.7	20:20	1.2	1.0	4:15	4.5	11:20	8.4	6.4	0:45	0.065	11:20	0.234	0.141	0.141	0.36
1/27/2018	0:05	0.7	21:25	1.2	1.0	4:10	4.8	16:35	8.5	6.8	0:05	0.065	16:35	0.213	0.133	0.133	0.61
1/28/2018	23:25	0.9	15:00	1.4	1.1	4:50	4.6	15:10	8.6	6.8	5:25	0.082	18:35	0.269	0.152	0.152	0.07
1/29/2018	9:25	0.8	20:25	1.4	1.0	3:20	4.3	18:55	8.8	6.5	4:40	0.073	20:25	0.264	0.142	0.142	0.90
1/30/2018	2:35	0.7	18:05	1.4	1.0	1:50	4.4	14:05	8.1	6.3	2:35	0.061	18:05	0.261	0.130	0.130	0.00
1/31/2018	8:35	0.9	20:35	1.4	1.1	3:10	4.4	20:10	8.5	6.0	3:15	0.078	20:10	0.266	0.144	0.144	0.00
ReportAvg	1.0					6.8					0.143						
ReportTotal																4.426	8.79

ADS Environmental Services

Pipe Height: 12.00

Date	REN_MH6704\mp1\DFINAL (inches)					REN_MH6704\mp1\VFINAL (feet/sec)					REN_MH6704\mp1\QFINAL (MGD - Total MG)					REN_RG\mp1\RAIN (inches)	
	Time	Min.	Time	Max.	Average	Time	Min.	Time	Max.	Average	Time	Min.	Time	Max.	Average	Total	Total
2/1/2018	2:50	0.7	20:40	1.2	1.0	2:45	4.1	20:50	8.3	6.2	2:55	0.053	20:50	0.212	0.125	0.125	0.66
2/2/2018	3:45	0.7	12:25	1.2	0.9	3:10	4.6	7:40	8.7	6.3	4:05	0.061	12:25	0.234	0.114	0.114	0.04
2/3/2018	2:20	0.7	19:25	1.2	0.9	5:35	4.3	14:30	8.5	6.4	4:10	0.053	19:20	0.211	0.125	0.125	0.31
2/4/2018	3:40	0.7	8:15	1.3	1.0	3:15	4.5	15:25	8.6	6.4	3:40	0.057	15:15	0.218	0.130	0.130	0.02
2/5/2018	3:50	0.6	17:45	1.2	1.0	4:20	4.4	12:00	8.1	6.0	3:50	0.043	16:50	0.201	0.120	0.120	0.04
2/6/2018	2:55	0.6	9:50	1.7	1.0	3:20	4.2	9:50	9.0	6.0	2:55	0.040	9:50	0.381	0.119	0.119	0.00
2/7/2018	2:25	0.6	19:05	1.2	0.9	4:15	4.3	20:25	8.0	5.7	2:25	0.042	19:05	0.197	0.109	0.109	0.00
2/8/2018	3:25	0.6	17:05	1.2	0.9	4:35	4.1	20:15	8.0	5.6	3:25	0.041	17:05	0.188	0.102	0.102	0.09
2/9/2018	3:40	0.6	16:05	1.1	0.9	3:25	4.2	13:05	7.9	5.8	3:40	0.043	16:05	0.181	0.103	0.103	0.01
2/10/2018	4:05	0.6	10:45	1.2	0.9	5:40	4.1	21:40	8.7	5.9	4:05	0.041	21:40	0.198	0.114	0.114	0.01
2/11/2018	3:50	0.7	16:25	1.4	1.0	3:50	4.0	14:00	8.3	5.9	3:50	0.043	14:05	0.224	0.120	0.120	0.00
2/12/2018	4:10	0.7	9:00	1.2	0.9	2:00	4.2	21:00	8.0	5.6	4:05	0.048	21:00	0.191	0.102	0.102	0.00
2/13/2018	1:20	0.6	7:20	1.3	0.9	1:25	4.1	18:45	7.8	5.6	1:25	0.044	7:00	0.186	0.108	0.108	0.17
2/14/2018	4:00	0.6	19:45	1.2	0.9	2:30	4.1	12:40	8.2	5.6	4:00	0.043	13:00	0.215	0.105	0.105	0.15
2/15/2018	1:45	0.6	16:55	1.2	0.9	3:05	4.1	17:30	7.5	5.7	1:45	0.043	16:55	0.191	0.104	0.104	0.00
2/16/2018	4:45	0.6	11:05	1.3	0.9	4:45	4.2	11:00	8.6	5.7	4:45	0.043	11:05	0.224	0.103	0.103	0.15
2/17/2018	3:35	0.6	15:25	1.3	1.0	1:50	4.1	12:10	8.3	6.1	3:35	0.044	15:25	0.226	0.123	0.123	0.32
2/18/2018	4:55	0.6	11:30	1.2	1.0	5:25	4.2	11:45	8.1	6.0	5:10	0.045	11:45	0.228	0.122	0.122	0.01
2/19/2018	0:30	0.6	11:00	1.3	1.0	4:35	4.1	15:30	8.1	5.6	0:30	0.038	15:30	0.221	0.113	0.113	0.00
2/20/2018	5:00	0.6	16:35	1.3	1.0	3:30	4.0	19:35	7.7	5.6	2:40	0.041	16:35	0.210	0.110	0.110	0.00
2/21/2018	1:45	0.6	18:55	1.2	0.9	1:30	4.1	20:40	7.4	5.4	1:50	0.040	20:25	0.194	0.103	0.103	0.00
2/22/2018	2:40	0.6	18:10	1.2	0.9	4:45	4.1	15:05	7.7	5.5	2:40	0.043	18:10	0.188	0.102	0.102	0.07
2/23/2018	0:45	0.7	9:05	1.3	1.0	3:50	4.0	16:55	7.4	5.4	0:45	0.050	8:55	0.173	0.104	0.104	0.01
2/24/2018	2:55	0.7	10:55	1.2	0.9	4:50	4.1	12:30	7.9	5.6	1:45	0.051	10:55	0.202	0.106	0.106	0.13
2/25/2018	4:45	0.7	20:20	1.3	1.0	3:10	4.2	9:40	8.7	5.9	4:45	0.049	20:20	0.247	0.120	0.120	0.11
2/26/2018	0:15	0.7	13:30	1.4	1.0	4:15	4.0	9:30	8.1	5.6	0:15	0.050	13:30	0.254	0.120	0.120	0.00
2/27/2018	13:40	0.7	17:50	1.4	1.0	1:40	3.8	17:55	7.7	5.6	4:35	0.064	17:50	0.249	0.118	0.118	0.19
2/28/2018	0:50	0.7	18:40	1.3	1.0	2:55	3.8	17:20	7.9	5.6	3:55	0.048	19:05	0.207	0.116	0.116	0.35
ReportAvg	1.0					5.8					0.113						
ReportTotal																3.157	2.84

ADS Environmental Services

Pipe Height: 12.00

Date	REN_MH6704\mp1\DFINAL (inches)					REN_MH6704\mp1\VFINAL (feet/sec)					REN_MH6704\mp1\QFINAL (MGD - Total MG)						REN_RG\mp1\RAIN (inches)		
	Time	Min.	Time	Max.	Average	Time	Min.	Time	Max.	Average	Time	Min.	Time	Max.	Average	Total	Total		
3/1/2018	2:45	0.6	18:00	1.3	1.0	3:00	4.0	17:50	7.9	5.7	2:45	0.039	17:45	0.224	0.119	0.119	0.01		
3/2/2018	3:55	0.8	19:10	1.2	1.0	3:15	4.1	18:55	7.6	5.6	3:55	0.056	18:55	0.202	0.116	0.116	0.07		
3/3/2018	4:35	0.8	11:05	1.3	1.0	2:35	4.2	13:15	8.3	5.8	2:30	0.059	13:15	0.231	0.130	0.130	0.00		
3/4/2018	3:30	0.7	13:30	1.3	1.0	4:05	3.7	11:50	8.1	5.9	3:30	0.049	13:30	0.231	0.135	0.135	0.12		
3/5/2018	2:40	0.8	12:40	1.3	1.0	3:05	3.9	19:25	8.0	5.7	2:40	0.054	20:15	0.206	0.116	0.116	0.00		
3/6/2018	4:05	0.6	20:15	1.3	1.0	3:25	3.9	20:40	8.0	5.5	4:00	0.041	20:40	0.219	0.106	0.106	0.00		
3/7/2018	1:55	0.6	19:55	1.4	1.1	2:10	3.9	10:20	7.8	5.5	2:05	0.039	19:55	0.266	0.133	0.133	0.03		
3/8/2018	2:30	0.8	21:05	1.5	1.2	2:45	3.8	18:15	8.5	5.7	2:30	0.061	18:15	0.293	0.153	0.153	0.37		
3/9/2018	13:10	0.8	17:20	1.3	1.1	2:20	4.0	19:40	7.9	5.6	2:15	0.068	19:40	0.243	0.124	0.124	0.00		
3/10/2018	2:55	0.8	11:10	1.5	1.1	3:35	3.6	13:55	8.3	5.5	2:55	0.050	11:10	0.280	0.141	0.141	0.00		
3/11/2018	5:25	0.8	11:05	1.4	1.1	4:55	3.8	11:35	7.5	5.4	5:25	0.061	11:05	0.247	0.134	0.134	0.00		
3/12/2018	4:20	0.8	18:20	1.4	1.1	1:50	3.8	20:05	7.5	5.3	2:35	0.061	19:45	0.228	0.122	0.122	0.00		
3/13/2018	3:50	0.8	19:35	1.3	1.0	3:15	3.8	19:40	7.7	5.5	3:50	0.059	17:45	0.219	0.119	0.119	0.31		
3/14/2018	1:05	0.8	20:05	1.3	1.0	0:55	3.9	6:45	7.4	5.5	0:55	0.061	20:05	0.215	0.121	0.121	0.04		
3/15/2018	0:45	0.8	11:45	1.4	1.1	1:30	4.3	20:45	7.4	5.4	0:45	0.064	20:45	0.222	0.127	0.127	0.00		
3/16/2018	3:25	0.9	17:10	1.3	1.1	0:35	4.1	9:10	7.2	5.5	3:25	0.070	17:25	0.215	0.134	0.134	0.00		
3/17/2018	4:30	0.8	20:05	1.5	1.1	4:05	4.3	19:05	7.9	5.7	4:30	0.070	19:50	0.241	0.142	0.142	0.00		
3/18/2018	3:45	0.8	10:05	1.5	1.2	2:30	4.2	13:30	8.6	6.0	3:45	0.061	11:00	0.299	0.157	0.157	0.00		
3/19/2018	0:25	0.8	19:00	1.4	1.1	1:50	4.1	12:35	8.5	5.5	23:30	0.065	19:00	0.232	0.128	0.128	0.00		
3/20/2018	23:30	0.8	19:45	1.3	1.1	2:25	3.8	10:55	7.8	5.4	2:25	0.057	10:55	0.232	0.126	0.126	0.00		
3/21/2018	3:35	0.8	19:40	1.3	1.0	22:50	4.0	18:05	7.7	5.4	3:35	0.057	18:05	0.217	0.117	0.117	0.10		
3/22/2018	2:20	0.8	18:35	1.3	1.1	1:35	4.0	9:40	7.6	5.5	3:20	0.060	9:40	0.218	0.125	0.125	0.48		
3/23/2018	1:05	0.8	11:30	1.3	1.0	2:10	3.9	7:15	7.9	5.5	2:35	0.059	11:30	0.236	0.121	0.121	0.31		
3/24/2018	0:50	0.8	16:35	1.3	1.1	4:55	4.1	13:35	8.5	5.7	2:10	0.061	13:35	0.246	0.136	0.136	0.28		
3/25/2018	5:50	0.7	19:30	1.3	1.1	4:40	4.1	10:45	8.1	5.7	5:50	0.053	11:15	0.241	0.131	0.131	0.01		
3/26/2018	23:15	0.8	16:40	1.3	1.0	1:10	4.1	20:10	7.7	5.6	23:35	0.056	19:50	0.221	0.121	0.121	0.17		
3/27/2018	0:05	0.7	19:40	1.3	1.0	1:25	4.1	19:40	8.0	5.5	0:05	0.054	19:40	0.242	0.119	0.119	0.02		
3/28/2018	23:55	0.7	19:25	1.3	1.0	3:20	4.1	18:25	7.9	5.5	0:10	0.055	18:25	0.219	0.116	0.116	0.01		
3/29/2018	0:00	0.7	13:40	1.3	1.0	4:05	4.2	18:00	8.7	5.5	0:00	0.055	13:40	0.220	0.115	0.115	0.00		
3/30/2018	0:05	0.7	19:20	1.3	1.0	1:25	4.1	10:55	7.5	5.5	0:05	0.052	17:55	0.203	0.120	0.120	0.00		
3/31/2018	4:10	0.8	7:35	1.3	1.1	0:55	4.1	11:20	8.0	5.7	0:45	0.059	11:20	0.222	0.130	0.130	0.00		
ReportAvg					1.1					5.6							0.127		
ReportTotal																	3.935	2.33	

ADS Environmental Services

Pipe Height: 12.00

Date	REN_MH6704\mp1\DFINAL (inches)					REN_MH6704\mp1\VFINAL (feet/sec)					REN_MH6704\mp1\QFINAL (MGD - Total MG)					REN_RG\mp1\RAIN (inches)	
	Time	Min.	Time	Max.	Average	Time	Min.	Time	Max.	Average	Time	Min.	Time	Max.	Average	Total	Total
4/1/2018	18:30	0.8	10:45	1.3	1.0	3:45	4.0	10:20	8.1	5.7	3:45	0.059	10:20	0.242	0.128	0.128	0.10
4/2/2018	22:35	0.7	19:20	1.3	1.0	2:35	4.0	19:20	7.9	5.6	22:30	0.056	19:20	0.244	0.122	0.122	0.00
4/3/2018	7:10	0.8	18:20	1.3	1.0	1:00	4.1	17:10	7.7	5.5	0:45	0.060	9:20	0.205	0.110	0.110	0.00
4/4/2018	23:25	0.6	19:20	1.4	1.0	0:20	4.0	16:30	7.8	5.5	23:25	0.040	19:20	0.238	0.120	0.120	0.39
4/5/2018	12:20	0.7	20:20	1.2	0.9	0:50	4.1	19:10	8.2	5.6	22:05	0.057	19:25	0.190	0.108	0.108	0.25
4/6/2018	23:20	0.8	16:20	1.3	1.0	3:45	4.0	16:20	8.4	5.6	23:20	0.063	16:20	0.251	0.118	0.118	0.00
4/7/2018	13:55	0.7	5:25	1.4	1.0	1:15	4.1	10:15	8.2	5.8	1:15	0.058	8:55	0.237	0.130	0.130	0.88
4/8/2018	19:10	0.9	10:20	1.4	1.1	2:35	4.2	9:55	8.6	6.0	2:40	0.069	10:10	0.253	0.145	0.145	0.45
4/9/2018	21:55	0.8	9:45	1.3	1.0	1:15	4.2	10:30	7.7	5.7	3:30	0.066	9:50	0.227	0.125	0.125	0.00
4/10/2018	23:30	0.6	8:05	1.2	0.9	2:15	4.1	9:20	7.9	5.7	23:30	0.045	8:10	0.195	0.101	0.101	0.23
4/11/2018	0:20	0.6	15:35	1.2	0.9	0:45	4.0	20:20	8.0	5.7	0:30	0.041	15:30	0.186	0.095	0.095	0.31
4/12/2018	0:15	0.6	13:10	1.4	1.0	0:15	4.1	7:55	8.0	5.6	0:15	0.042	13:10	0.245	0.108	0.108	0.11
4/13/2018	0:30	0.7	5:50	1.3	1.0	4:45	4.2	13:55	8.2	5.9	0:30	0.053	9:30	0.202	0.115	0.115	0.51
4/14/2018	0:35	0.8	19:30	1.5	1.1	3:50	4.1	16:05	8.5	6.7	0:35	0.062	19:25	0.311	0.169	0.169	1.52
4/15/2018	23:35	1.0	10:25	1.5	1.2	4:10	4.9	13:40	8.7	7.0	23:40	0.102	10:25	0.300	0.189	0.189	0.21
4/16/2018	0:00	0.9	12:10	1.5	1.2	3:10	4.5	12:10	8.3	6.5	0:00	0.089	12:10	0.312	0.177	0.177	0.71
4/17/2018	22:40	0.9	7:05	1.4	1.2	2:05	4.5	12:15	8.4	6.5	22:40	0.083	7:05	0.246	0.168	0.168	0.01
4/18/2018	20:35	0.9	17:35	1.4	1.1	0:05	4.4	10:45	8.2	6.3	1:35	0.077	17:35	0.248	0.157	0.157	0.12
4/19/2018	21:25	0.9	8:35	1.4	1.1	1:25	4.4	18:25	8.3	6.3	1:35	0.083	18:25	0.259	0.148	0.148	0.00
4/20/2018	22:25	0.6	14:30	1.3	1.0	3:50	4.4	12:05	8.0	6.2	22:25	0.054	9:10	0.225	0.120	0.120	0.00
4/21/2018	23:45	0.5	9:35	1.3	1.0	3:45	4.3	17:05	8.1	6.3	23:45	0.036	9:35	0.247	0.125	0.125	0.05
4/22/2018	0:40	0.5	9:35	1.2	0.9	3:35	4.2	13:55	8.3	6.1	0:40	0.037	11:05	0.193	0.107	0.107	0.00
ReportAvg	1.0					6.0					0.131						
ReportTotal																2.886	5.85

REN_RG

Located At: 3555 Ne 2nd St (see attached site report for details)
Monitoring Period: December 22, 2017 – April 22, 2018

RG Data Uptime: The data uptime achieved during the monitoring period is provided in the table below.

Entity	Percentage Uptime Raw	Percentage Uptime Final
Depth (in)	100%	100%
Velocity (f/s)	100%	100%
Quantity (mgd)	100%	100%

Renton.Carollo.I&I.WA17

Flow Monitoring Site Report



Site Name

REN_RG

Site Address /Location:	3555 NE 2nd St		Monitor Series	Location Type
Site Access Details:	Renton Public Works Maintenance division, in field on horseshoe goal.	Latitude:	Rain Alert III	Temporary
		Longitude:	Pipe Size (H x W)	Pipe Shape
			NA	Non-Standard

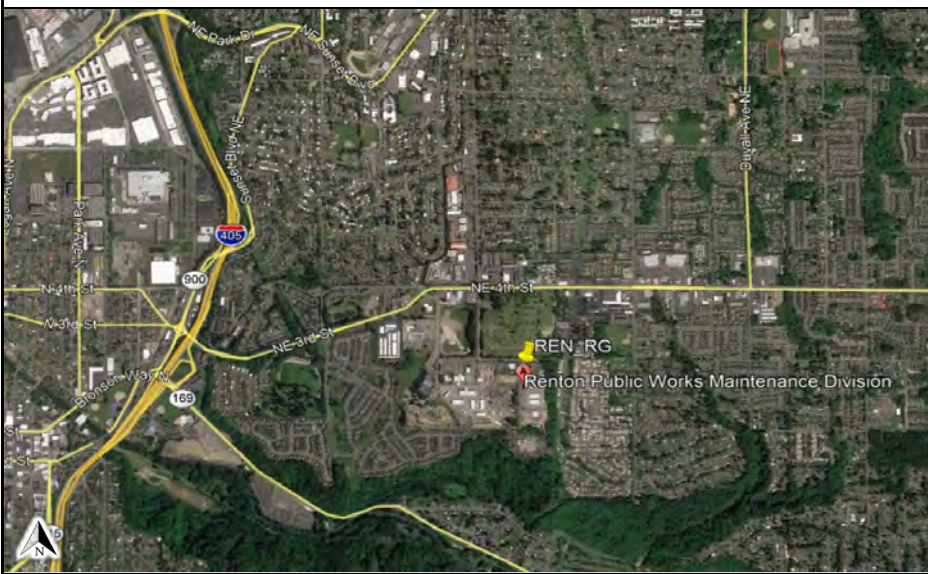

Manhole #	System Characteristics
Rain Gauge	Other
Access	Traffic
Drive	Light



Installation Information	
Installation Date:	Installation Type:
12.22.17	Rain Gauge
Monitoring Location (Sensors):	Monitor Location:
Rooftop	Building
Sensors / Devices:	Pressure Sensor Range (psi)
Rain Gauge Tipping Bucket	

Installation Confirmation:	
Confirmation Time:	Pipe Size (HxW)
-	NA
Depth of Flow (Wet DOF) (in)	Range (Air DOF) (in)
-	
Downlooker Physical Offset (in)	Measurement Confidence (in)
-	
Peak Velocity (fps)	Velocity Sensor Offset (in)
-	
Silt (in)	Silt Type
-	

Hydraulic Comments:
NA

Manhole / Pipe Information:	
Manhole Depth (Approx. FT):	Manhole Configuration
-	Single
Manhole Material:	Manhole Condition:
Manhole Opening Diameter (in)	Manhole Diameter (Approx.):
-	-
Manhole Cover	Manhole Frame
Active Drop Connections	Air Quality:
	Normal
Pipe Material	Pipe Condition:

Communication Information:	
Communication Type	Antenna Location
Wireless	

Additional Site Info. / Comments:
Located on paved goal of horseshoe tossing area outside of building.



ADS Project Name:	Renton.Carollo.I&I.WA17
ADS Project Number:	22275.11.325

ADS Environmental Services

Date	REN_RG\mp1\RAIN (inches)
12/22/2017	0.10
12/23/2017	0.00
12/24/2017	0.00
12/25/2017	0.14
12/26/2017	0.17
12/27/2017	0.00
12/28/2017	0.25
12/29/2017	1.57
12/30/2017	0.02
12/31/2017	0.00
ReportAvg	
ReportTotal	2.25

ADS Environmental Services

Date	REN_RG\mp1\RAIN (inches)
1/1/2018	0.00
1/2/2018	0.01
1/3/2018	0.00
1/4/2018	0.09
1/5/2018	0.42
1/6/2018	0.24
1/7/2018	0.38
1/8/2018	0.14
1/9/2018	0.46
1/10/2018	0.22
1/11/2018	1.04
1/12/2018	0.20
1/13/2018	0.02
1/14/2018	0.00
1/15/2018	0.04
1/16/2018	0.26
1/17/2018	0.79
1/18/2018	0.40
1/19/2018	0.10
1/20/2018	0.10
1/21/2018	0.16
1/22/2018	0.34
1/23/2018	0.79
1/24/2018	0.51
1/25/2018	0.14
1/26/2018	0.36
1/27/2018	0.61
1/28/2018	0.07
1/29/2018	0.90
1/30/2018	0.00
1/31/2018	0.00
ReportAvg	
ReportTotal	8.79

ADS Environmental Services

Date	REN_RG\mp1\RAIN (inches)
2/1/2018	0.66
2/2/2018	0.04
2/3/2018	0.31
2/4/2018	0.02
2/5/2018	0.04
2/6/2018	0.00
2/7/2018	0.00
2/8/2018	0.09
2/9/2018	0.01
2/10/2018	0.01
2/11/2018	0.00
2/12/2018	0.00
2/13/2018	0.17
2/14/2018	0.15
2/15/2018	0.00
2/16/2018	0.15
2/17/2018	0.32
2/18/2018	0.01
2/19/2018	0.00
2/20/2018	0.00
2/21/2018	0.00
2/22/2018	0.07
2/23/2018	0.01
2/24/2018	0.13
2/25/2018	0.11
2/26/2018	0.00
2/27/2018	0.19
2/28/2018	0.35
ReportAvg	
ReportTotal	2.84

ADS Environmental Services

Date	REN_RG\mp1\RAIN (inches)
3/1/2018	0.01
3/2/2018	0.07
3/3/2018	0.00
3/4/2018	0.12
3/5/2018	0.00
3/6/2018	0.00
3/7/2018	0.03
3/8/2018	0.37
3/9/2018	0.00
3/10/2018	0.00
3/11/2018	0.00
3/12/2018	0.00
3/13/2018	0.31
3/14/2018	0.04
3/15/2018	0.00
3/16/2018	0.00
3/17/2018	0.00
3/18/2018	0.00
3/19/2018	0.00
3/20/2018	0.00
3/21/2018	0.10
3/22/2018	0.48
3/23/2018	0.31
3/24/2018	0.28
3/25/2018	0.01
3/26/2018	0.17
3/27/2018	0.02
3/28/2018	0.01
3/29/2018	0.00
3/30/2018	0.00
3/31/2018	0.00
ReportAvg	
ReportTotal	2.33

ADS Environmental Services

Date	REN_RG\mp1\RAIN (inches)
4/1/2018	0.10
4/2/2018	0.00
4/3/2018	0.00
4/4/2018	0.39
4/5/2018	0.25
4/6/2018	0.00
4/7/2018	0.88
4/8/2018	0.45
4/9/2018	0.00
4/10/2018	0.23
4/11/2018	0.31
4/12/2018	0.11
4/13/2018	0.51
4/14/2018	1.52
4/15/2018	0.21
4/16/2018	0.71
4/17/2018	0.01
4/18/2018	0.12
4/19/2018	0.00
4/20/2018	0.00
4/21/2018	0.05
4/22/2018	0.00
ReportAvg	
ReportTotal	5.85

RDII Analysis

This section describes an evaluation of wet weather impacts on system flows by summarizing excess flow rates and volumes from the studied sewer shed areas (basins) associated with each flow monitoring site during rain events that occurred during the study period. This section also describes an evaluation of dry weather flow data for purposes of determining base wastewater flows (to compare wet weather flows against).

Base Dry Weather Analysis

Prior to conducting a wet weather analysis, a dry weather analysis must first be performed by reviewing data obtained during dry weather conditions. For this analysis, a *dry day* is defined as any day in which there was less than 0.10 in. of rain in the previous day, less than 0.40 in. of rain in the previous three days, and less than 1.00 in. of rain in the previous five days. This process automatically eliminates the selection of most wet weather events and the periods associated with recovery from these events. Once the initial dry days are selected, they are compared to one another to make sure that the flow pattern for each day is repeatable. Any days that have an inconsistent flow pattern are removed from consideration. The resulting dry days are then averaged to establish an average diurnal flow pattern from the site. The dry weather analysis evaluates the weekday pattern separate from the weekend pattern to account for differences often observed.

Dry weather flows were evaluated for each basin during the study period. Recorded flow rates from the sanitary sewer monitoring location for each dry day are overlaid on a hydrograph, enabling a typical or average dry day flow (ADF) and minimum daily flow (MDF) to be determined for Weekdays and Weekends (gross flow basis) as depicted in Figure 1.1 for basin REN_MH1360.

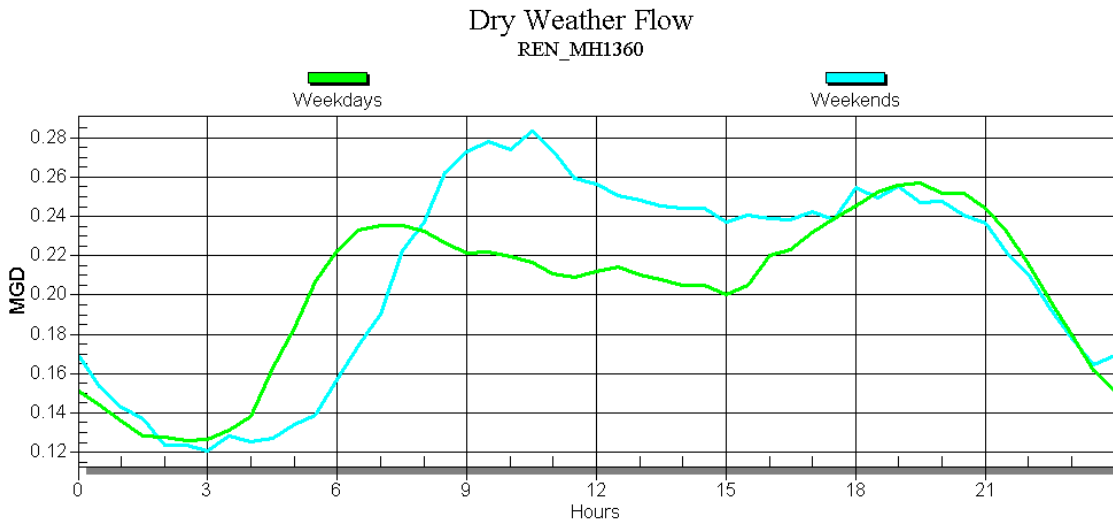

Figure 1.1 summarizes the gross flow values for ADF for weekdays and weekends.

It is possible to estimate the volume of flow from each sewer shed area that is attributable to groundwater infiltration (or Base Infiltration – BI) based on an evaluation of ADF and MDF values against expected wastewater flow generation rates from sewer shed areas

comprised of typical residential/commercial land uses. The most refined empirical method to estimate BI is the Stevens/Schutzbach equation. The Equation below is the Stevens/Schutzbach equation that was used to estimate BI from these areas.

$$BI = \frac{0.4 * MDF}{1 - 0.6 (MDF/ADF) + ADF^{0.7}}$$

Reliability of BI calculations decreases in non-residential basins and in basins where the flow meter measures flow from cycling pump stations or other unusual flow patterns. It is important to understand that when only using flow data, BI is considered an estimate and only through more rigorous means of flow isolations (e.g. plugging all lateral connections in isolated small areas of the system and physically measuring continued flow during the plugging period) can actual BI values be determined. The BI as a percentage of average daily flow is presented below in Tables 1.1 and Table 1.2.

The dry day weather flow for each site's tributary area (or gross flow which includes any upstream basins) is presented in Table 1.1 below. Weekday dry days were calculated separately from weekend dry days due to the sites having different hydraulic patterns on weekdays compared to weekends. Table 1.2 presents the net dry weather flow summary for each basin (or net flow which subtracts flow from upstream basins). In order to isolate flows from Basins REN_MH3625 and REN_MH1360 subtraction of upstream site flows was required. To calculate net flow for these basins the following calculations were made: REN_MH1360 = REN_MH1360 - REN_MH4628; Also, REN_MH3625 = REN_MH3625 - REN_MH5505.

Dry Weather Flow Summary (Gross)									
Basin	Average Daily Flow (mgd)		Minimum Daily Flow (mgd)		Maximum Daily Flow (mgd)		Base Infiltration (mgd)		Base Infiltration/ADF (%)
	Weekdays	Weekends	Weekdays	Weekends	Weekdays	Weekends	Weekdays	Weekends	Weekdays
REN_MH0166	0.015	0.005	0.007	0.002	0.027	0.011	0.002	0.002	13%
REN_MH0286	0.073	0.048	0.055	0.045	0.095	0.053	0.052	0.045	71%
REN_MH0537	0.317	0.317	0.207	0.204	0.399	0.408	0.164	0.161	52%
REN_MH1360	0.203	0.211	0.126	0.121	0.257	0.283	0.104	0.096	51%
REN_MH1763	0.167	0.178	0.071	0.080	0.233	0.273	0.054	0.061	32%
REN_MH2116	0.574	0.571	0.411	0.391	0.654	0.721	0.315	0.292	55%
REN_MH2171	0.184	0.146	0.093	0.098	0.282	0.188	0.072	0.086	39%
REN_MH2252	0.648	0.674	0.432	0.390	0.838	0.930	0.311	0.259	48%
REN_MH2999	0.175	0.186	0.122	0.126	0.214	0.232	0.106	0.108	61%
REN_MH3216	0.050	0.046	0.022	0.023	0.070	0.072	0.020	0.020	40%
REN_MH3625	0.533	0.587	0.301	0.313	0.738	0.817	0.206	0.205	39%
REN_MH4628	0.163	0.171	0.118	0.117	0.196	0.214	0.104	0.101	64%
REN_MH4646	0.296	0.205	0.171	0.168	0.229	0.246	0.158	0.153	53%
REN_MH5302	1.689	1.690	1.078	0.981	2.012	2.084	0.628	0.540	37%
REN_MH5505	0.211	0.212	0.167	0.157	0.238	0.250	0.150	0.138	71%
REN_MH5519	0.319	0.297	0.187	0.174	0.385	0.399	0.142	0.133	45%
REN_MH6041	0.047	0.041	0.017	0.017	0.067	0.060	0.014	0.015	30%
REN_MH6704	0.114	0.129	0.063	0.066	0.157	0.190	0.053	0.054	46%

Table 1.1 Summarizes the base infiltration and minimum, average, and maximum daily flows.

Dry Weather Flow Summary (Net)									
Basin	Average Daily Flow (mgd)		Minimum Daily Flow (mgd)		Maximum Daily Flow (mgd)		Base Infiltration (mgd)		Base Infiltration/ADF (%)
	Weekdays	Weekends	Weekdays	Weekends	Weekdays	Weekends	Weekdays	Weekends	Weekdays
REN_MH0166	0.015	0.005	0.007	0.002	0.027	0.011	0.002	0.002	13%
REN_MH0286	0.073	0.048	0.055	0.045	0.095	0.053	0.052	0.045	71%
REN_MH0537	0.317	0.317	0.207	0.204	0.399	0.408	0.164	0.161	52%
REN_MH1360 (REN_MH1360-REN_MH4628)	0.041	0.040	0.007	0.002	0.620	0.740	0.000	0.000	<5%
REN_MH1763	0.167	0.178	0.071	0.080	0.233	0.273	0.054	0.061	32%
REN_MH2116	0.574	0.571	0.411	0.391	0.654	0.721	0.315	0.292	55%
REN_MH2171	0.184	0.146	0.093	0.098	0.282	0.188	0.072	0.086	39%
REN_MH2252	0.648	0.674	0.432	0.390	0.838	0.930	0.311	0.259	48%
REN_MH2999	0.175	0.186	0.122	0.126	0.214	0.232	0.106	0.108	61%
REN_MH3216	0.050	0.046	0.022	0.023	0.070	0.072	0.020	0.020	40%
REN_MH3625 (REN_MH3625-REN_MH5505)	0.322	0.375	0.131	0.152	0.500	0.572	0.056	0.067	17%
REN_MH4628	0.163	0.171	0.118	0.117	0.196	0.214	0.104	0.101	64%
REN_MH4646	0.296	0.205	0.171	0.168	0.229	0.246	0.158	0.153	53%
REN_MH5302	1.689	1.690	1.078	0.981	2.012	2.084	0.628	0.540	37%
REN_MH5505	0.211	0.212	0.167	0.157	0.238	0.250	0.150	0.138	71%
REN_MH5519	0.319	0.297	0.187	0.174	0.385	0.399	0.142	0.133	45%
REN_MH6041	0.047	0.041	0.017	0.017	0.067	0.060	0.014	0.015	30%
REN_MH6704	0.114	0.129	0.063	0.066	0.157	0.190	0.053	0.054	46%

Table 1.2 Summarizes the net base infiltration and net minimum, average, and maximum daily flows.

Wet Weather Analysis

A wet weather analysis is performed by comparing specific wet weather events to average dry weather flows (ADF). Four (4) rain events larger than one (1) inch were recorded and evaluated during the monitoring period. Based on these events, an analysis was conducted to characterize the impact of wet weather on flow measured in the basins. Rain totals for each of the Four (4) storms are presented in Table 1.3.

Rain Event Totals	
	RG (in)
1/23/2018	1.48
3/21/2018	1.17
4/7/2018	1.33
4/15/2018	2.95

Table 1.3 Storm Event Rain Totals

Recorded flow rates for a specific storm event are plotted against average dry weather conditions. The difference observed represents the rain-dependent inflow and infiltration (RDII or I/I) entering the sanitary sewer system upstream from this monitoring location and is called a storm hydrograph. Figure 1.2 depicts a storm hydrograph for site/basin REN_MH1360 during the storm on April 13, 2018.

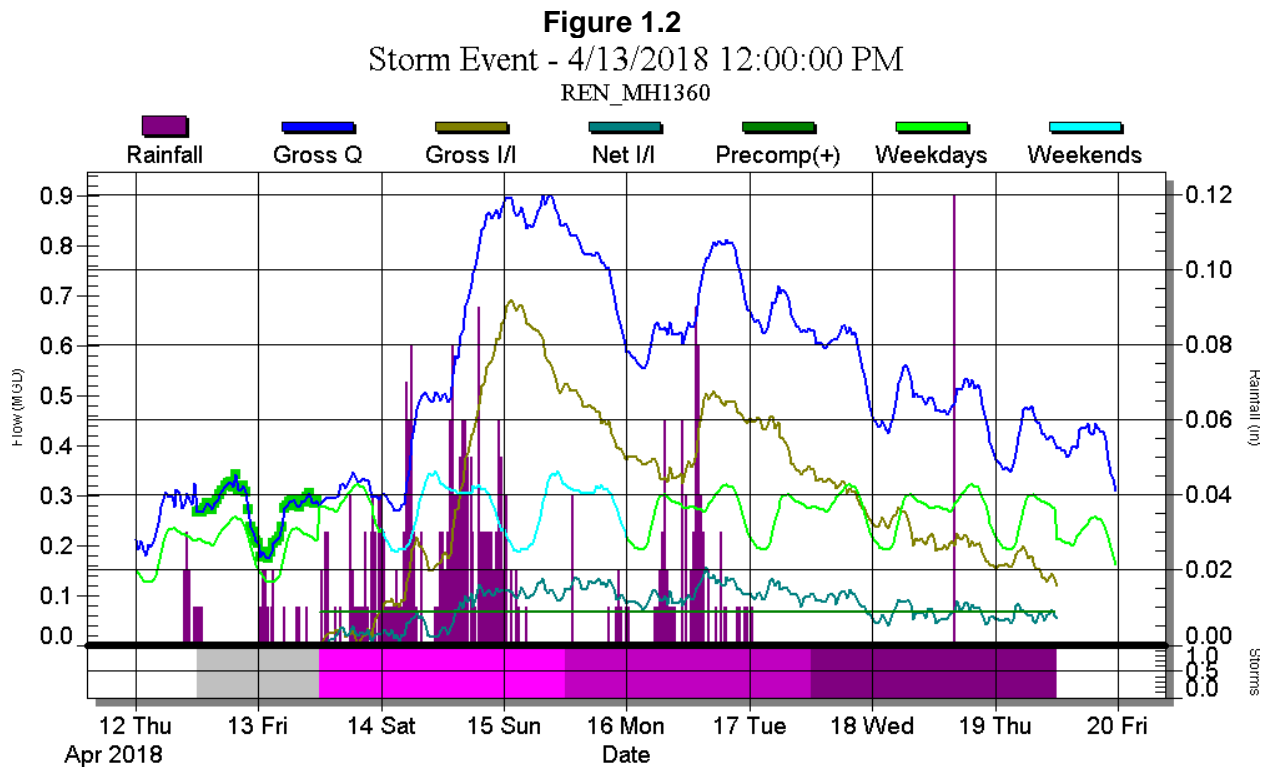

Figure 1.2 Storm hydrograph for site REN_MH1360

I/I calculations are made for each storm event, as shown in the colored bands above. The first period following the onset of rain is referred to as the Storm Period. The following period is referred to as Recovery 1, and the next period is referred to as Recovery 2. The Recovery 2 period was restricted as needed to not overlap the next storm. The entire period including storm and events 1 and 2 is this Event period. The storm hydrograph for this location showed a somewhat delayed but significant flow response to the rainfall during the April 13, 2018 storm. The brown line shown above displays the Gross I/I, while the lighter blue line displays the Net I/I contributed at the site after the flow was isolated from the upstream basin by subtracting flows upstream.

For each storm event a pre-compensation (or “precomp”) of the ADF data pattern occurs just before the storm and is highlighted by the gray bar in Figure 1.2. The average dry weekend or weekday is moved up or down as necessary to obtain the best fit with the flow in the sewer just before the storm. This is done to estimate and compare against the dry flow pattern that “would have” occurred if the storm did not occur. In Figure 1.2, the upward shift or positive “precomp+” of the comparator ADF data is evident. This effectively isolates only the truly rain storm dependent I/I (or RDII) by ignoring the already elevated flow rate present at the onset of the storm.

RDII

Once the calculations were complete for each storm, the Net RDII per storm event were graphed. The RDII results per storm event (MG) are show in Figures 1.3 and Table 1.4 and are based on the entire event periods (storm periods plus recovery periods). Figure 1.3 is sorted from high to low based on the largest storm that occurred on April 13, 2018.

Figure 1.3

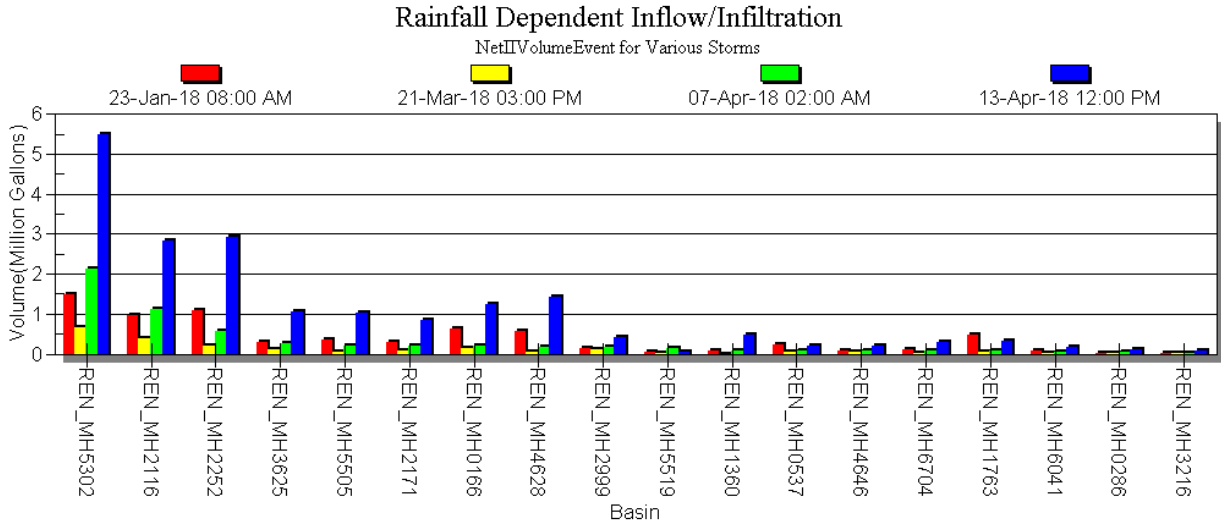

NetII Volume Event for Various Storms (MG)				
	1/23/2018 (1.48 in)	3/21/2018 (1.17 in)	4/7/2018 (1.33 in)	4/13/2018 (2.95 in)
REN_MH0166	0.64	0.14	0.18	1.21
REN_MH0286	0.02	0.01	0.04	0.12
REN_MH0537	0.22	0.04	0.07	0.20
REN_MH1360	0.06	<0.01	0.85	0.48
REN_MH1763	0.47	0.05	0.06	0.34
REN_MH2116	0.97	0.40	1.11	2.82
REN_MH2171	0.30	0.08	0.19	0.85
REN_MH2252	1.08	0.19	0.58	2.92
REN_MH2999	0.13	0.10	0.17	0.43
REN_MH3216	0.03	0.02	0.02	0.07
REN_MH3625	0.28	0.09	0.25	1.05
REN_MH4628	0.57	0.05	0.17	1.42
REN_MH4646	0.09	0.05	0.07	0.20
REN_MH5302	1.49	0.66	2.12	5.47
REN_MH5505	0.34	0.06	0.20	1.03

NetII Volume Event for Various Storms (MG)				
	1/23/2018 (1.48 in)	3/21/2018 (1.17 in)	4/7/2018 (1.33 in)	4/13/2018 (2.95 in)
REN_MH5519	0.04	0.02	0.13	0.04
REN_MH6041	0.09	0.01	0.05	0.16
REN_MH6704	0.10	0.03	0.06	0.28
Total	6.92	2.00	6.32	19.08

Table 1.4 Net II Volume Events for Various Storms (MG).

Normalized RDII

To enable a comparison of RDII between basins of differing sizes, the RDII volumes for each basin were normalized by dividing each basin's net RDII values by the area of each basin (acres); then dividing by inches of rainfall to yield volume of rainfall. This yielded the % rainfall entering the basin collection system. Table 1.5 summarizes the Acreage (used in this analysis) and pipe length associated with each basin. A summary of the normalized RDII in each basin during each storm event is summarized in Figure 1.4 and Table 1.6. Figure 1.4 is sorted from high to low based on the largest storm that occurred on April 13, 2018.

Basin	Pipe Length	Acreage
MH0166	7848	124
MH0286	7199	138
MH0537	59708	353
MH1360	30805	171
MH1763	53835	323
MH2116	76537	463
MH2171	27132	158
MH2252	40774	722
MH2999	27711	224
MH3216	6244	56
MH3625	86021	594
MH4628	20489	113
MH4646	15397	96
MH5302	36717	383
MH5505	23462	144
MH5519	12905	93
MH6041	13162	64
MH6704	20191	91

Table 1.5 Basin Acreage and Pipe Length.

Figure 1.4
Rainfall Dependent Inflow/Infiltration

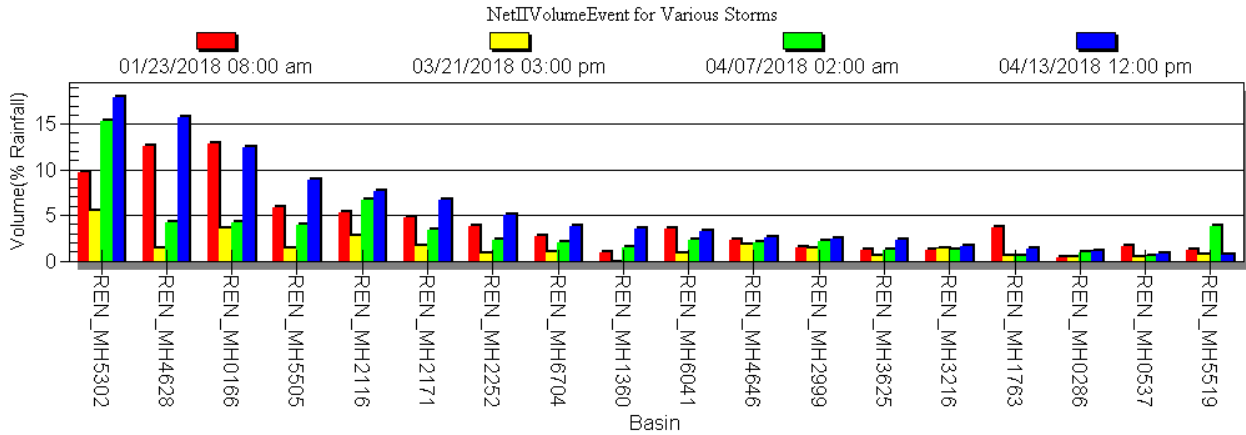

Normalized Net II Volume Event for Various Storms (%Rainfall)				
	1/23/2018 (1.48 in)	3/21/2018 (1.17 in)	4/7/2018 (1.33 in)	4/13/2018 (2.95 in)
REN_MH0166	12.84	3.65	4.01	12.20
REN_MH0286	0.31	0.29	0.83	1.09
REN_MH0537	1.53	0.35	0.54	0.70
REN_MH1360	0.92	<0.01	1.38	3.48
REN_MH1763	3.63	0.52	0.54	1.30
REN_MH2116	5.22	2.70	6.61	7.59
REN_MH2171	4.67	1.52	3.30	6.70
REN_MH2252	3.71	0.81	2.22	5.04
REN_MH2999	1.49	1.35	2.10	2.38
REN_MH3216	1.22	1.36	1.17	1.56
REN_MH3625	1.18	0.49	1.17	2.20
REN_MH4628	12.56	1.34	4.17	15.65
REN_MH4646	2.22	1.70	1.96	2.59
REN_MH5302	9.71	5.43	15.30	17.84
REN_MH5505	5.87	1.31	3.85	8.89
REN_MH5519	1.15	0.67	3.71	0.55
REN_MH6041	3.55	0.69	2.23	3.18
REN_MH6704	2.72	0.90	1.95	3.83

Table 1.6 Normalized Net II Volume Events for Various Storms (%rainfall).

Wet Season Peaking Factors

A hydraulic analysis was performed at each flow-monitoring site using gross wastewater flows to evaluate the entire tributary area for contribution of excess flow. The basis of this evaluation was to compare the peak-hour to average dry day flow ratios over the study period. The weekend or weekday ADF was selected for comparison based depending on if the peak hour occurred on a weekday or weekend. These flows are presented in Table 1.7. The Gross RDII peaking factors (defined as Gross Peak Hour / Gross ADF) are shown in Figure 1.5

Basin	Gross ADF (mgd)	Gross Peak Hour (mgd)	Day Peak Hour Occurred
MH0166	0.010	1.21	Weekday
MH0286	0.073	0.13	Weekday
MH0537	0.317	0.55	Weekday
MH1360	0.203	1.00	Weekday
MH1763	0.167	0.68	Weekday
MH2116	0.574	2.21	Weekday
MH2171	0.184	0.78	Weekday
MH2252	0.648	2.80	Weekday
MH2999	0.175	0.56	Weekday
MH3216	0.050	0.22	Weekday
MH3625	0.587	1.56	Weekend
MH4628	0.163	0.76	Weekday
MH4646	0.296	0.34	weekend
MH5302	1.689	5.11	Weekday
MH5505	0.212	0.64	Weekend
MH5519	0.319	0.39	Weekday
MH6041	0.047	0.30	Weekday
MH6704	0.114	0.38	Weekday

Table 1.6 ADF and Peak Hour Flow

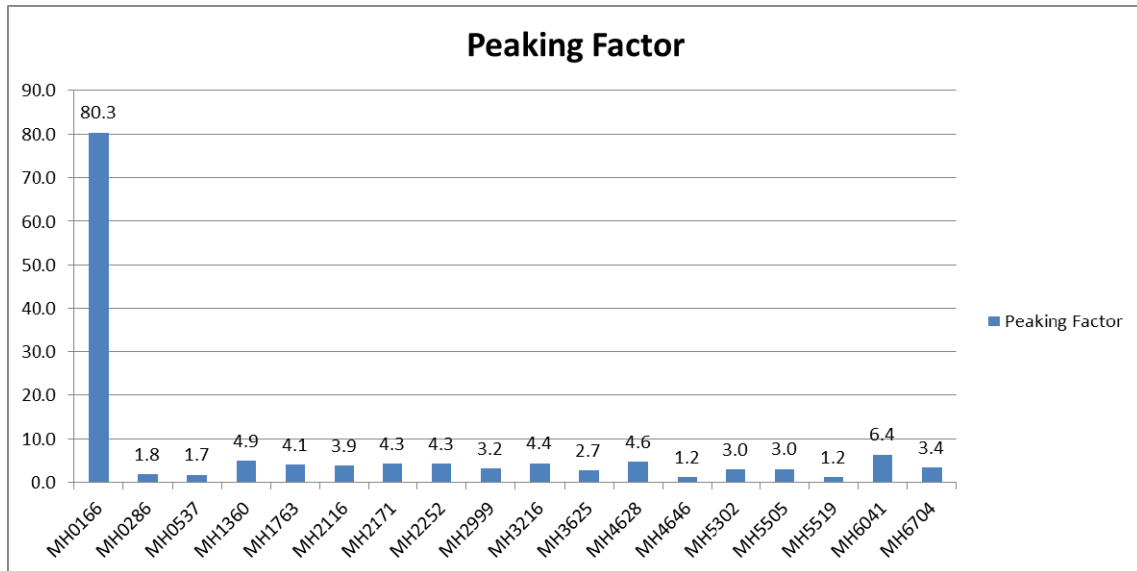

Figure 1.5 Peak Hour to Average Ratio

The net RDII peaking factors for these locations range from 1.2 to 80.3. REN_MH0166 had the most significant peaking factor due to a combination of RDII response and occasional dry weather flow surges that may have been coincident with rain responses.

Wet Weather RDII Volume Summary and Prioritization

RDII was evaluated for each basin during the four principal storm events. The evaluation of these basins was done based on the normalized RDII volumes for each basin.

Table 1.7 summarizes the BI as the percentage of ADF, net RDII, peaking factor (Gross Peak/ADF) and Normalized net RDII that occurred in each basin during the largest storm event which occurred on April 13, 2018.

Basin	Base Infiltration/ADF (%)	Gross Peak Hour/ADF	Net RDII (MG)	Normalized Net RDII (%Rainfall)
REN_MH0166	13%	80.3	1.21	12.20
REN_MH0286	71%	1.8	0.12	1.09
REN_MH0537	52%	1.7	0.20	0.70
REN_MH1360	<5%	4.9	0.48	3.48
REN_MH1763	32%	4.1	0.34	1.30
REN_MH2116	55%	3.9	2.82	7.59
REN_MH2171	39%	4.3	0.85	6.70

Basin	Base Infiltration/ADF (%)	Gross Peak Hour/ADF	Net RDII (MG)	Normalized Net RDII (%Rainfall)
REN_MH2252	48%	4.3	2.92	5.04
REN_MH2999	61%	3.2	0.43	2.38
REN_MH3216	40%	4.4	0.07	1.56
REN_MH3625	17%	2.7	1.05	2.20
REN_MH4628	64%	4.6	1.42	15.65
REN_MH4646	53%	1.2	0.20	2.59
REN_MH5302	37%	3.0	5.47	17.84
REN_MH5505	71%	3.0	1.03	8.89
REN_MH5519	45%	1.2	0.04	0.55
REN_MH6041	30%	6.4	0.16	3.18
REN_MH6704	46%	3.4	0.28	3.83

Table 1.7 RDII Results summary

There are seven locations with greater than 50% of their ADF comprised of BI. This suggests that groundwater infiltration is a predominant issue in these locations. The above net flow peaking factor yields basin REN_MH0166 as the highest priority basin for future evaluation for possible direct sources of inflow (e.g. areas drains or storm connection directly leading to the sanitary sewer). The normalized net RDII suggest basins REN_MH0166, REN_MH4628, REN_MH5302 and REN_MH4628 are the highest priority basins for future evaluation for RDII reduction. This may include CCTV verification of live leaks and lining of pipes, manholes and lateral connections.

Attachment B
ADWF DEVELOPMENT REVIEW PACKET

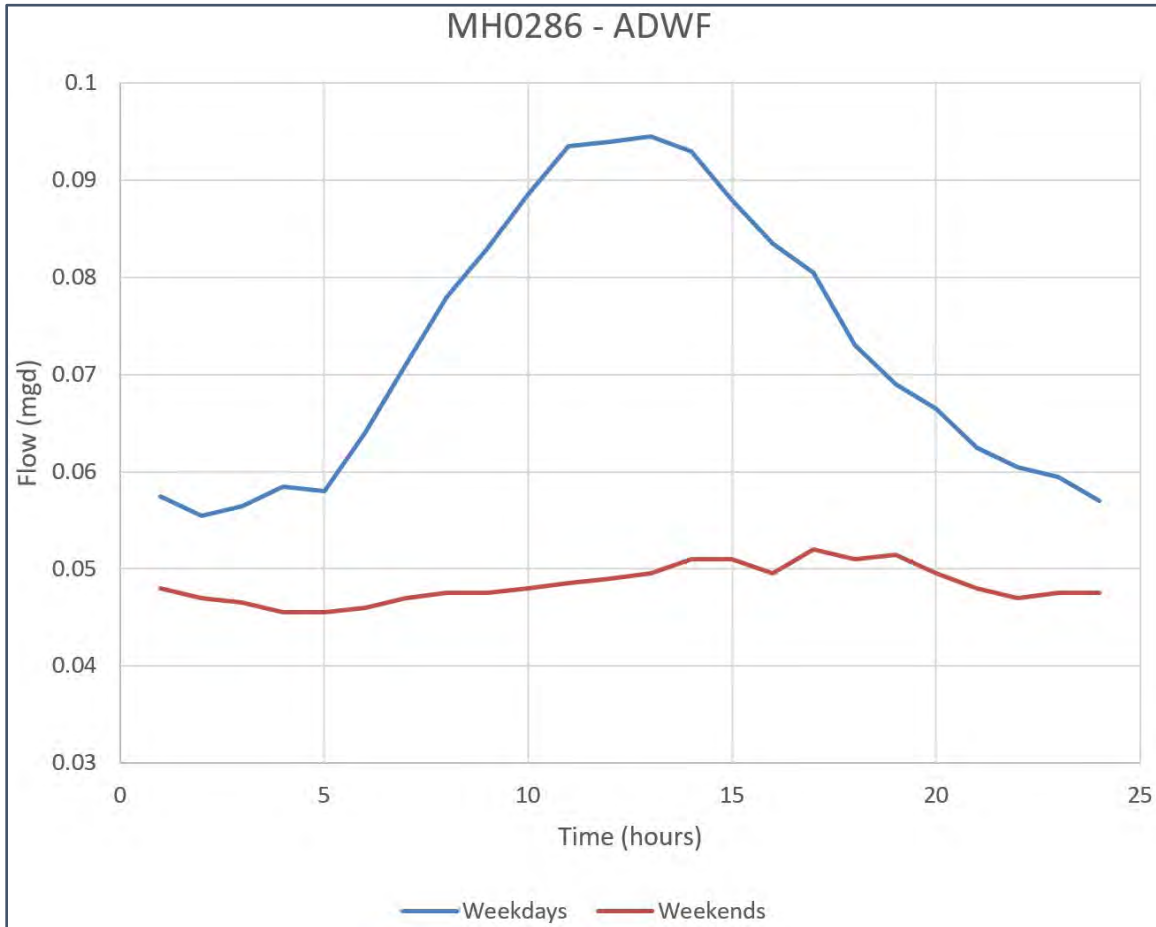
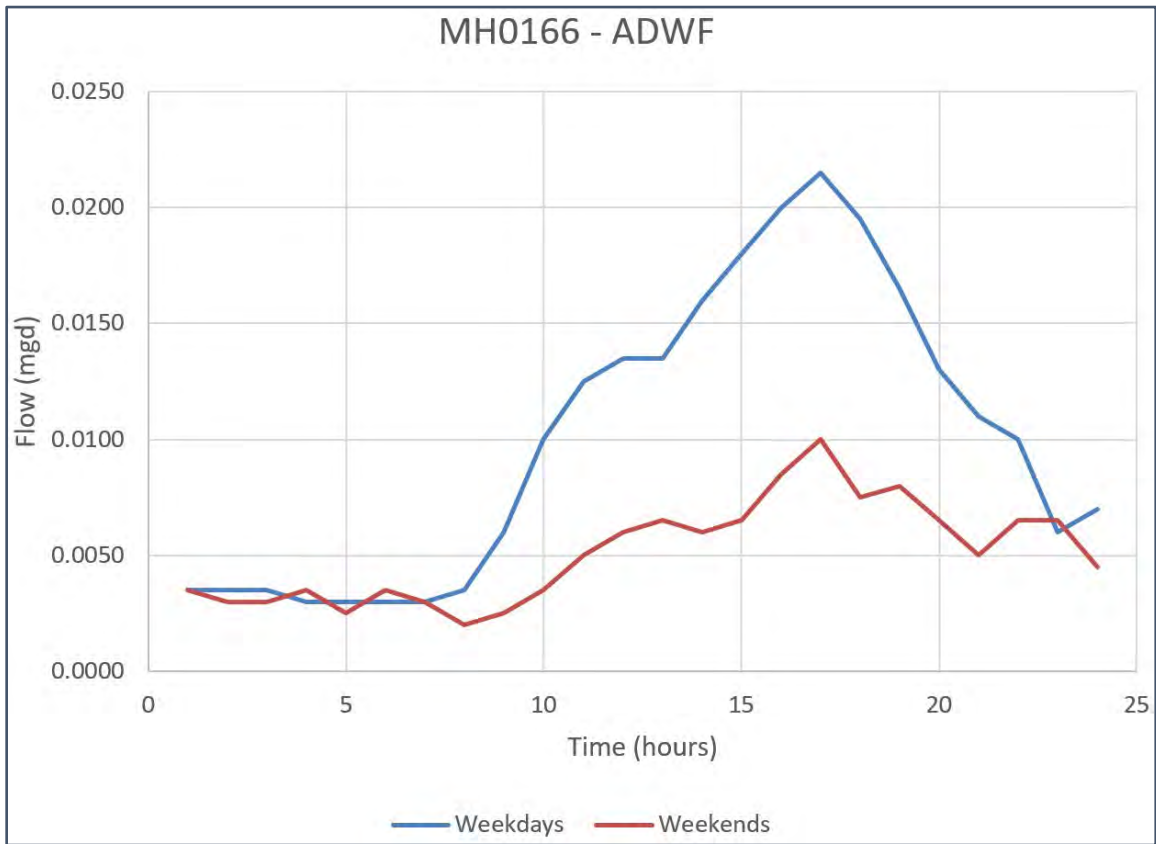

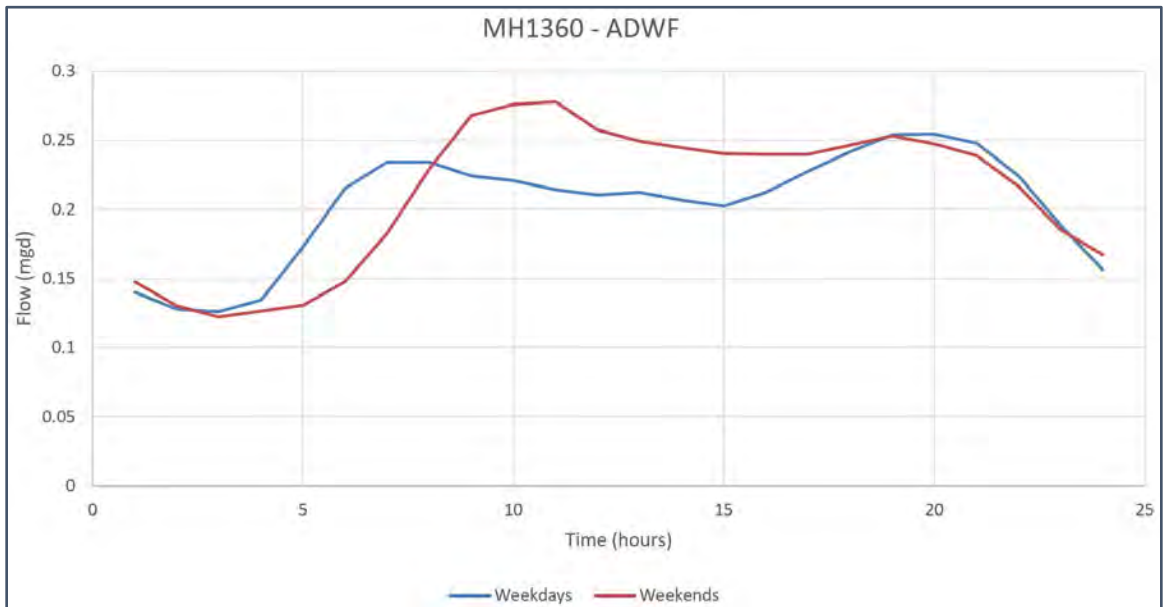
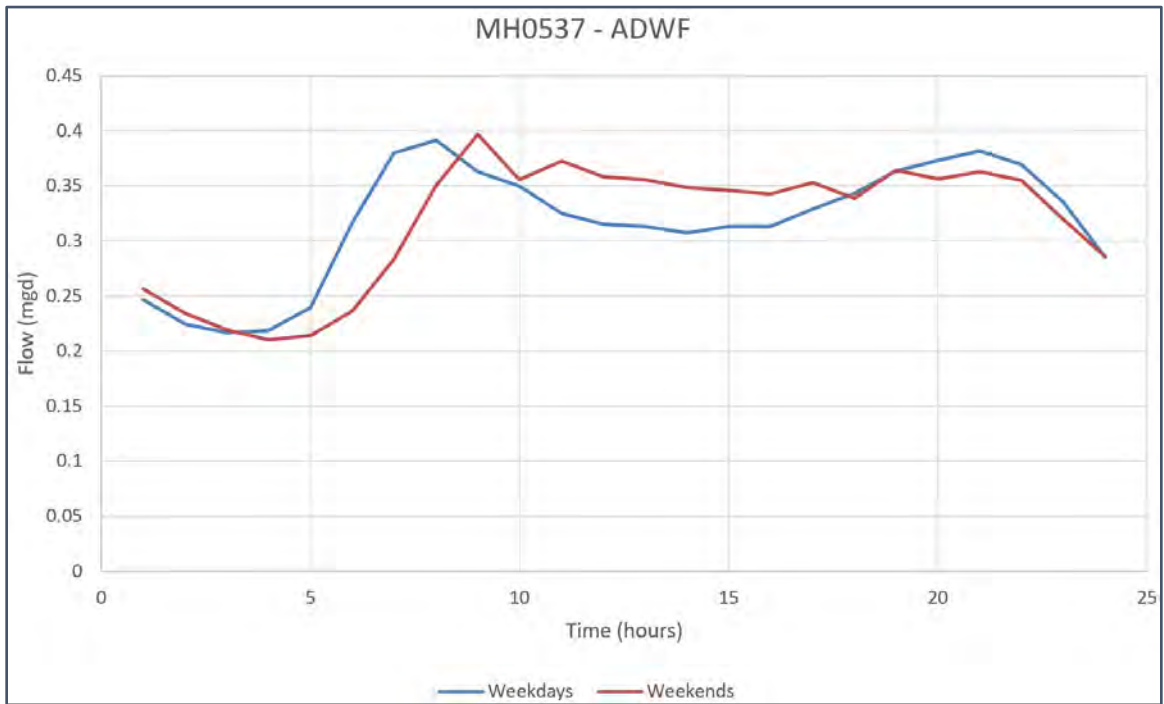

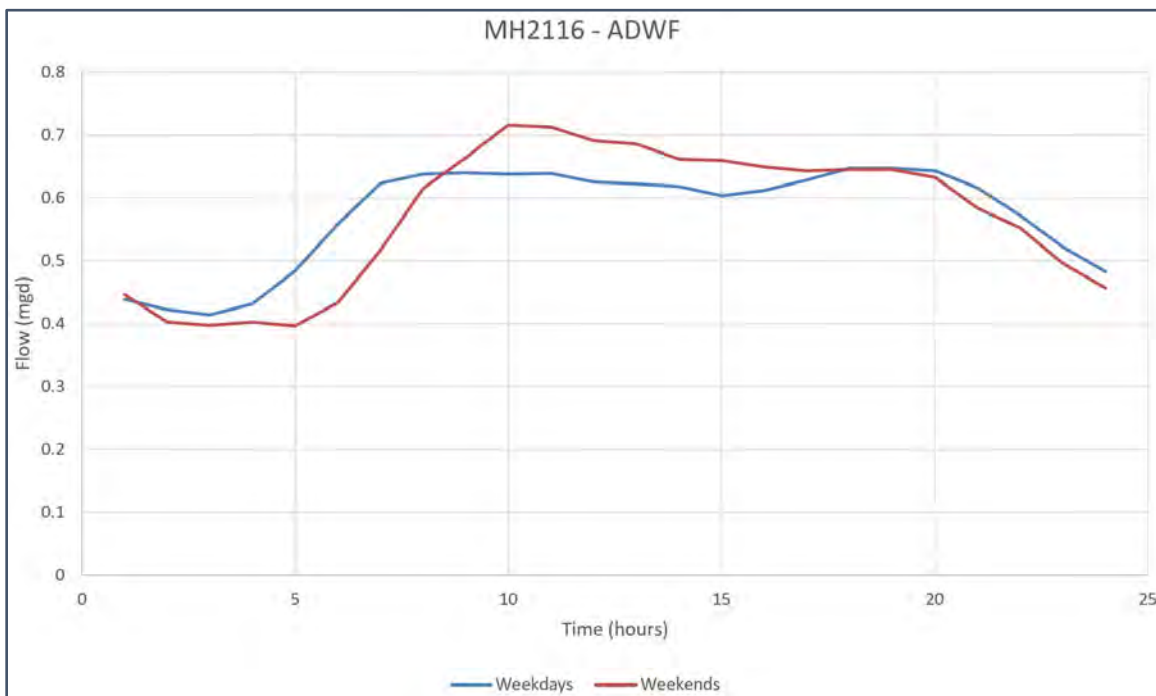
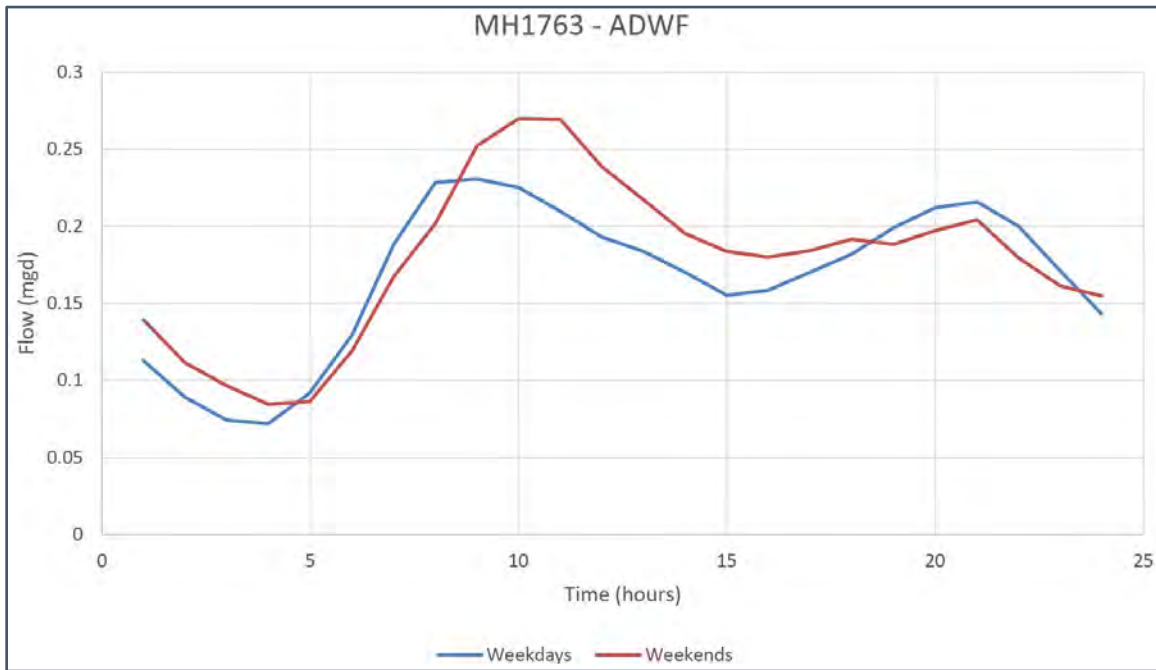

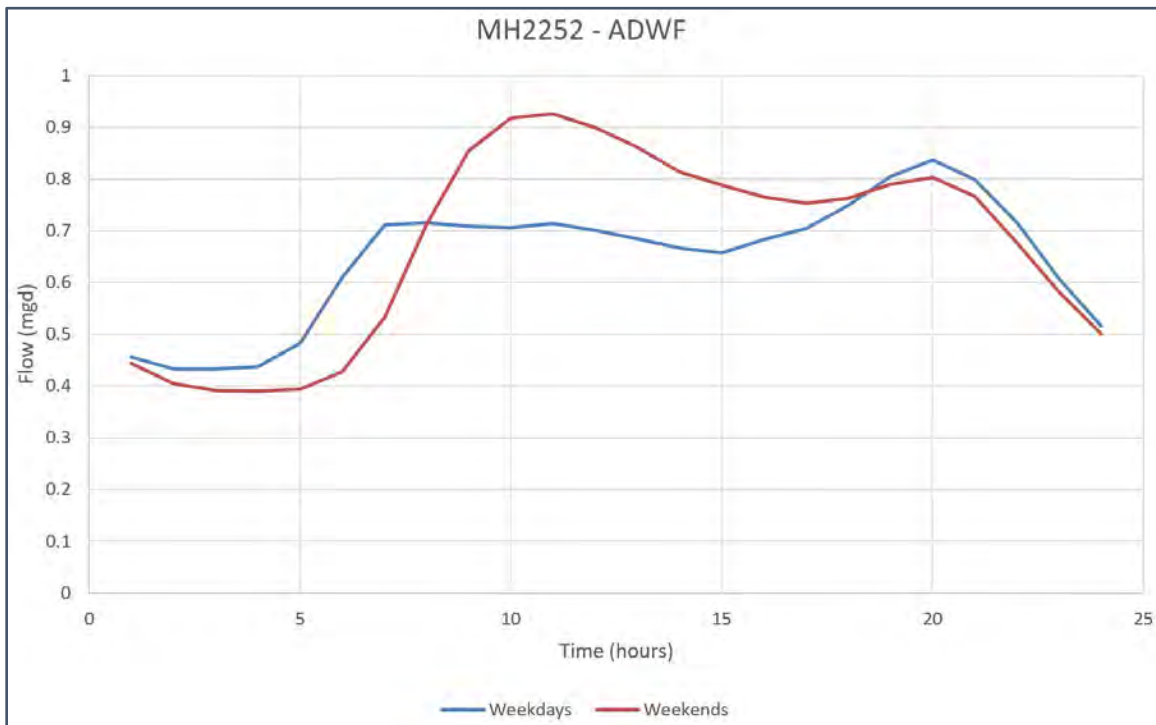
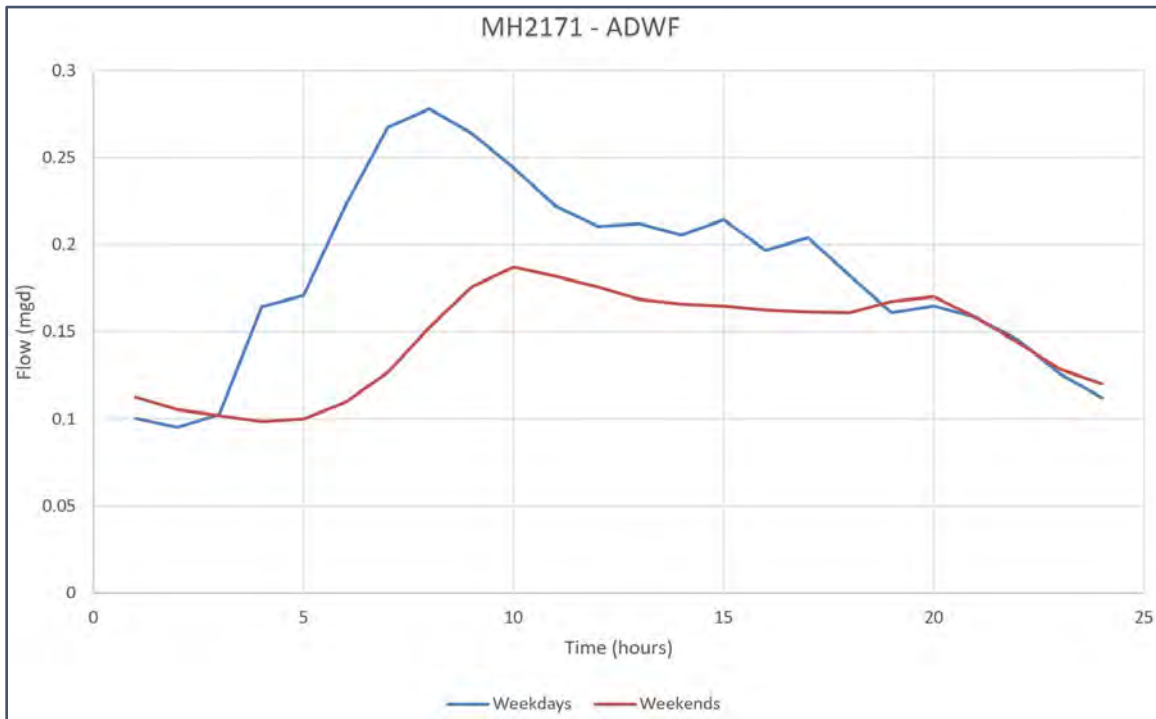

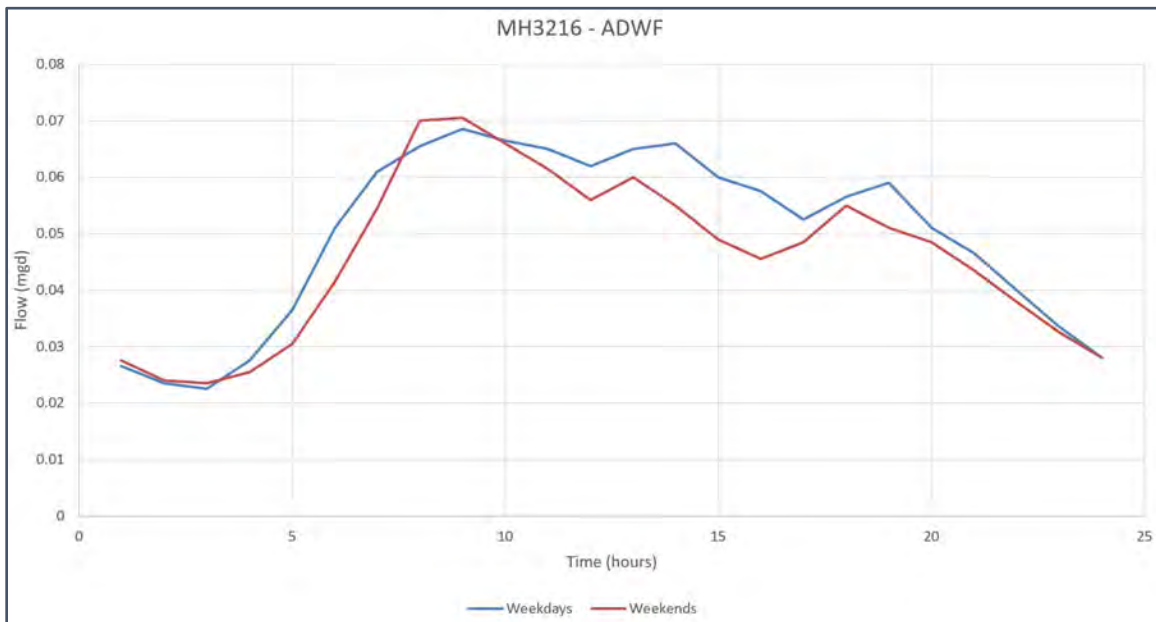
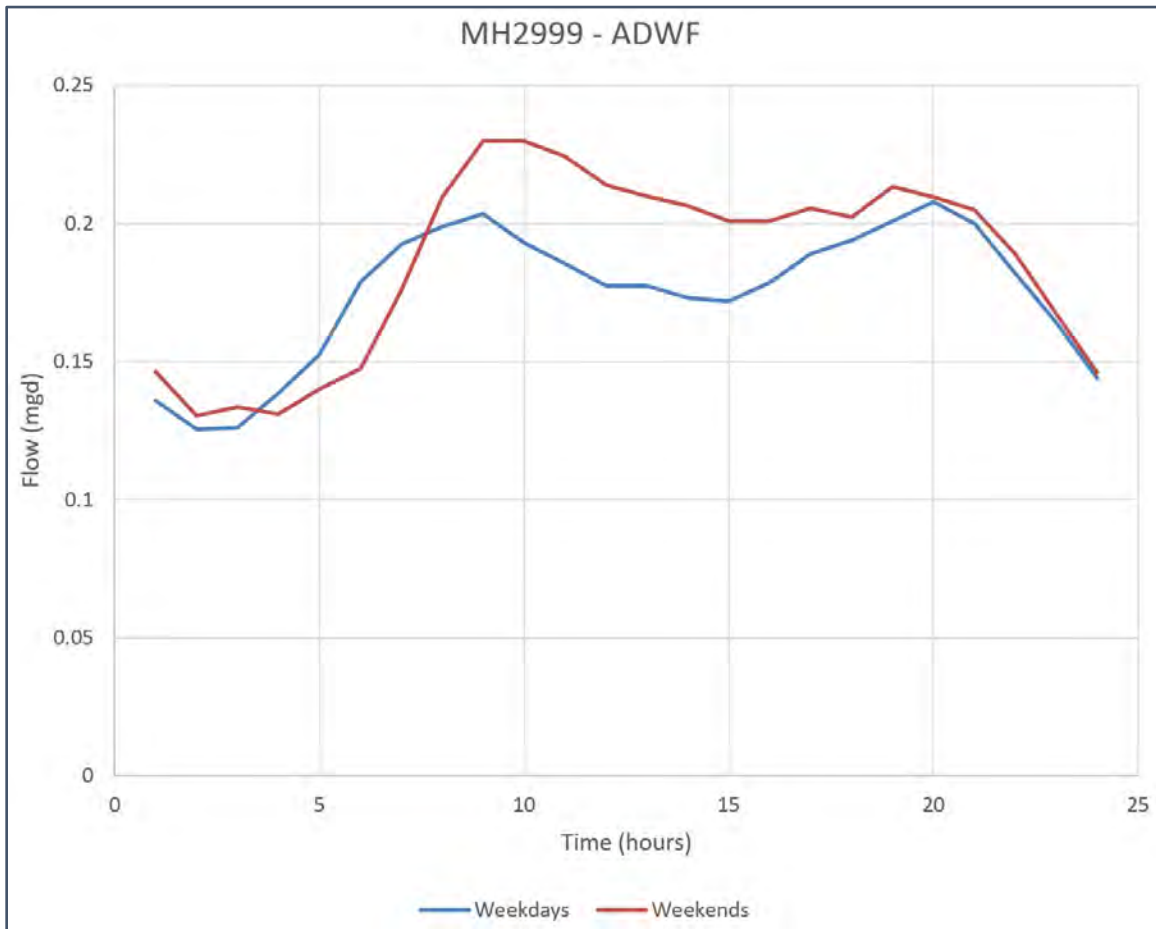

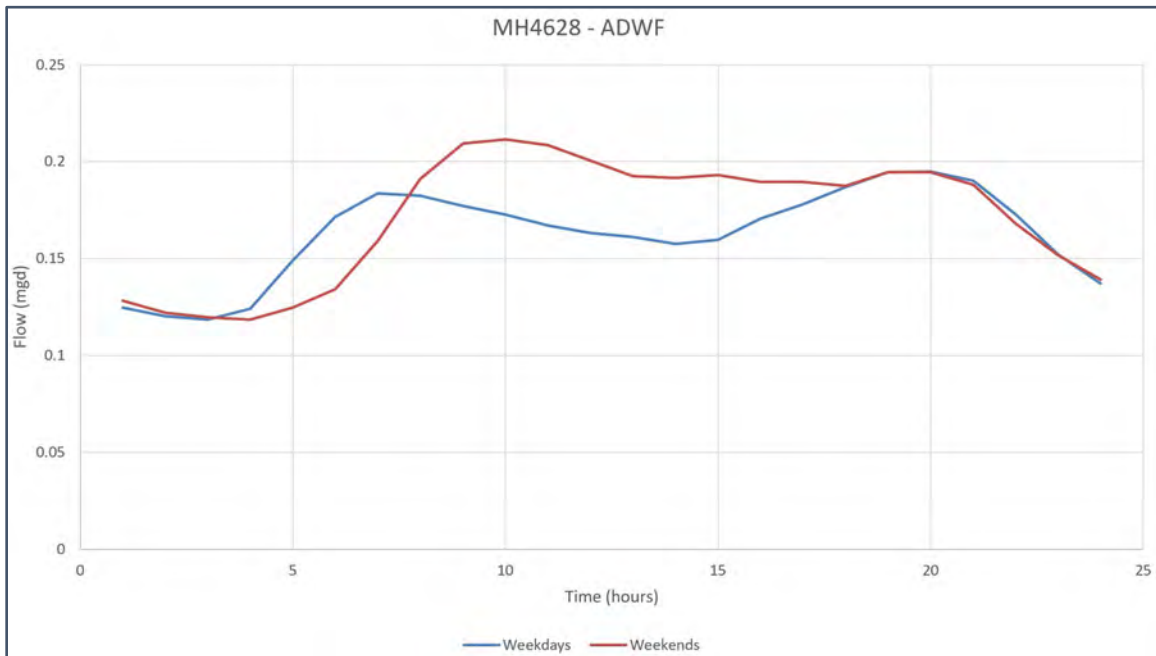

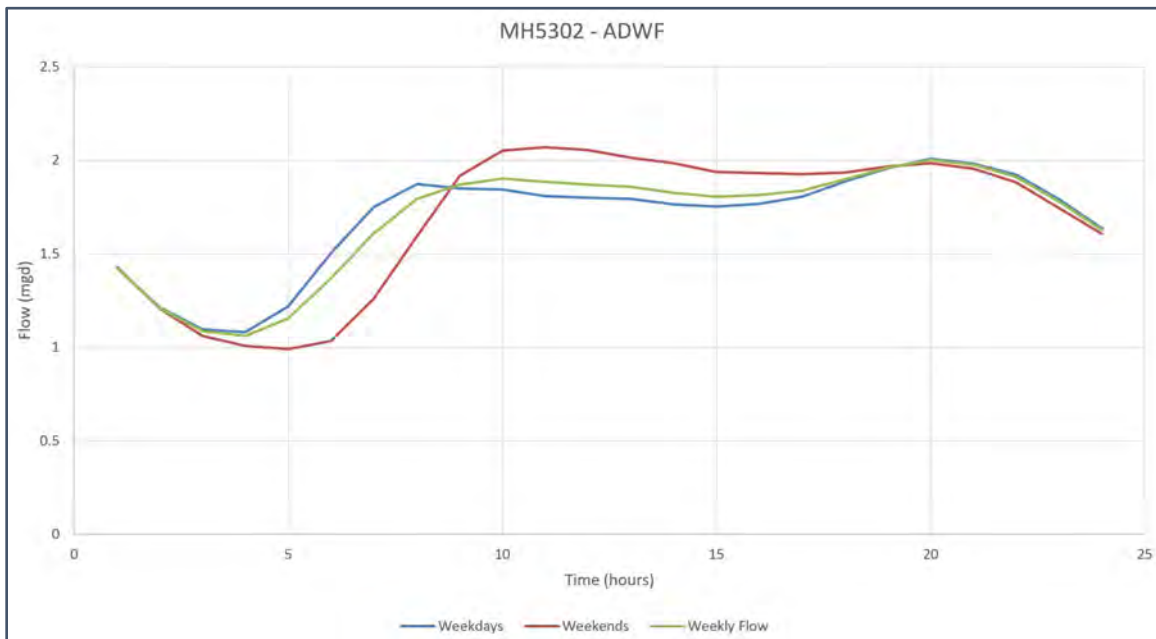
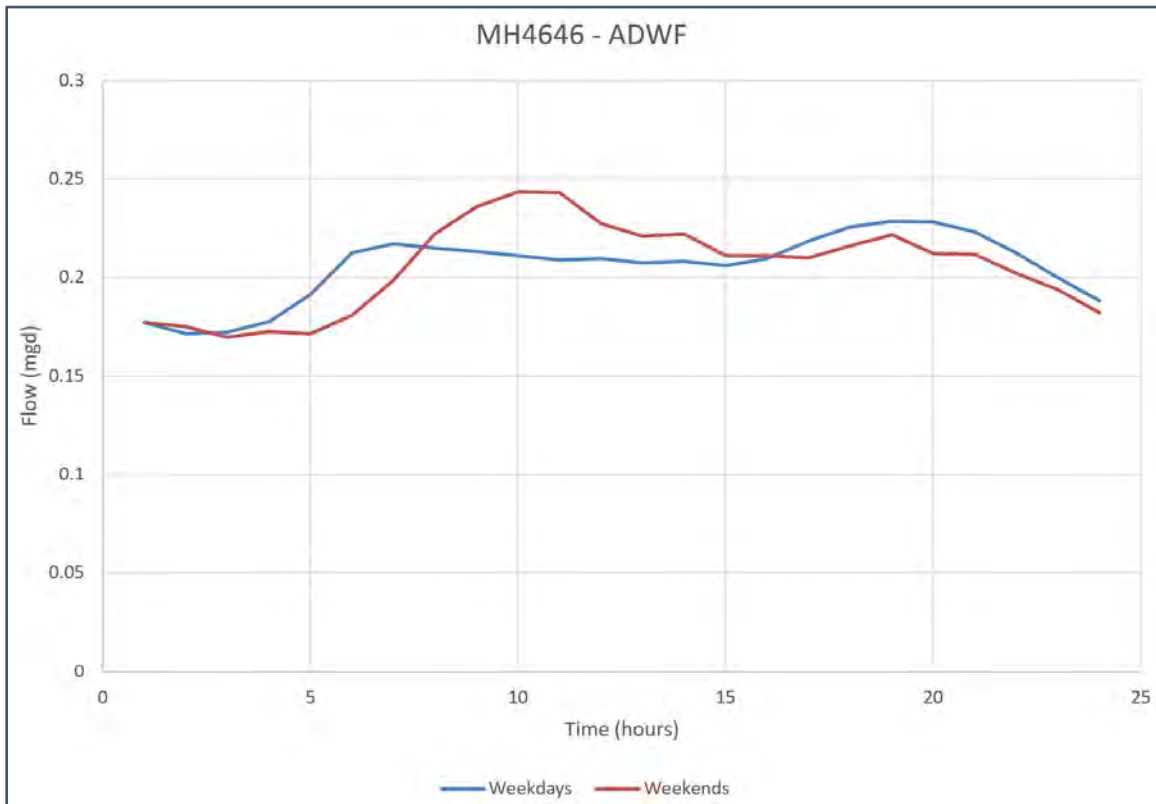

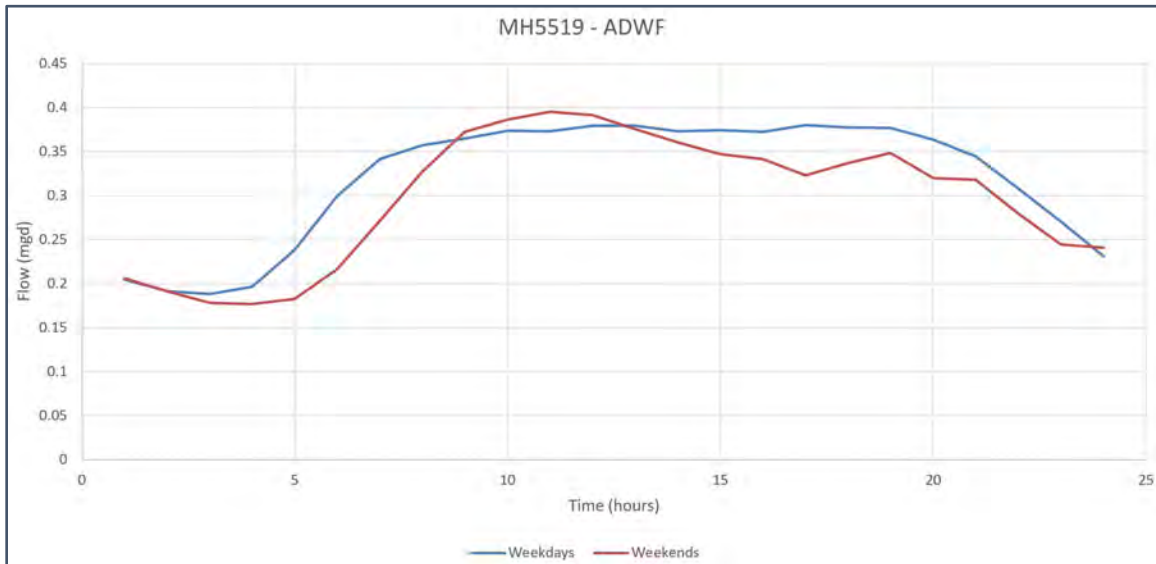
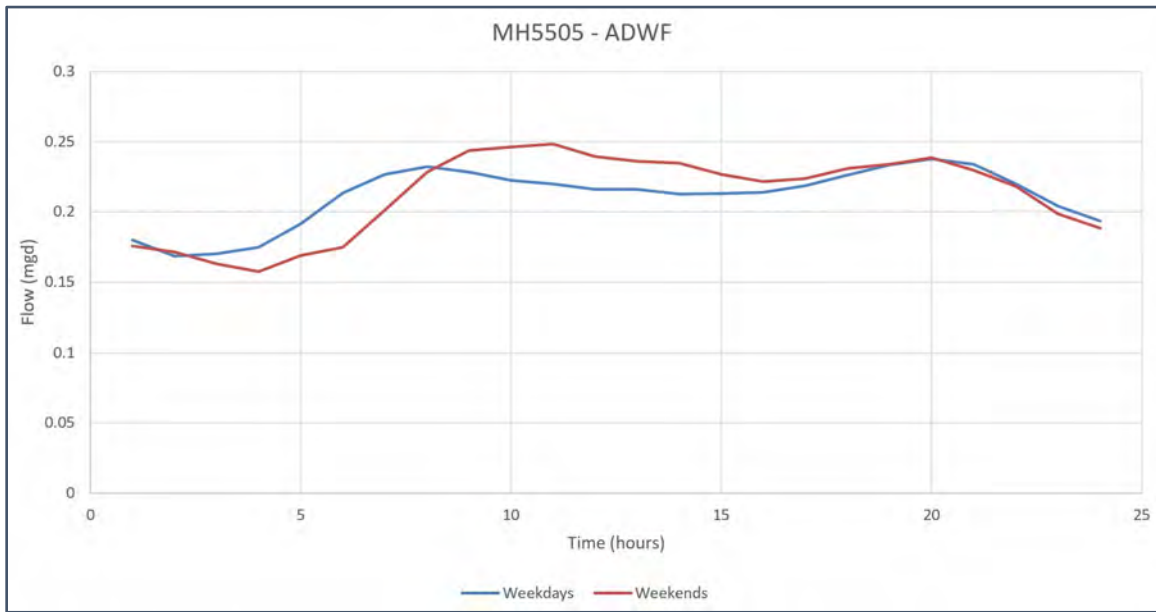

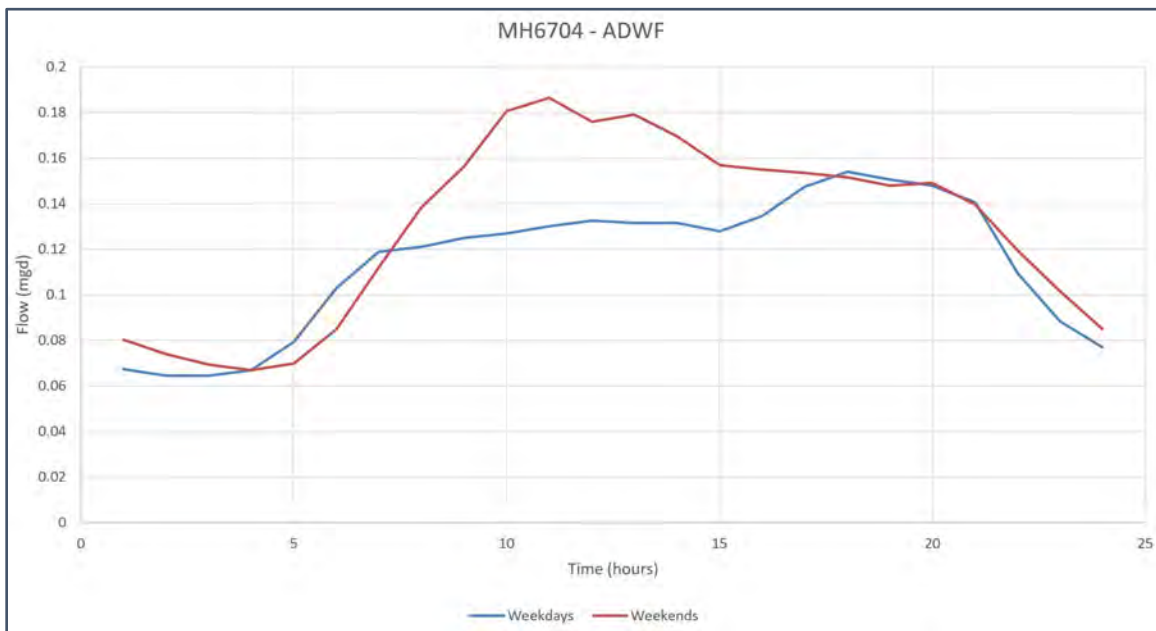

Appendix H
TM 2 - MODEL DEVELOPMENT AND
CALIBRATION



City of Renton
LRWWMP

Technical Memorandum 2 MODEL DEVELOPMENT AND CALIBRATION

DRAFT | September 2019





City of Renton
LRWWMP

Technical Memorandum 2 MODEL DEVELOPMENT AND CALIBRATION

DRAFT | September 2019

This document is released for the purpose of information exchange review and planning only under the authority of Daniel L. Reisinger, September 20, 2019 Washington PE License No. 53657.

Contents

Technical Memorandum 2 Model Development and Calibration	2-1
2.1 Hydraulic Model Overview	2-1
2.1.1 Hydraulic Modeling Software	2-1
2.1.2 Elements of the Hydraulic Model	2-1
2.2 Hydraulic Model Expansion and refinement	2-2
2.2.1 Model Update Process	2-3
2.2.2 Wastewater Flow Allocation	2-4
2.2.3 Inflow and Infiltration: Time-Area Model A and RDI	2-5
2.3 Hydraulic Model Calibration	2-7
2.3.1 Calibration Standards	2-7
2.3.2 Wet Weather Calibration Standards	2-7
2.3.3 Dry Weather Flow Calibration	2-8
2.3.4 Wet Weather Flow Calibration	2-10
2.3.5 Hydraulic Model Calibration Summary	2-15

Attachments

Attachment C	RDII Parameters
Attachment D	Negative Slope Pipelines List
Attachment E	Basin Diurnal Patterns
Attachment F	Dry Weather Calibration Results
Attachment G	Wet Weather Calibration Results

Tables

Table 2.1	Dry Weather Flow Calibration Results	2-9
Table 2.2	Wet Weather Flow Calibration Results	2-13

Figures

Figure 2.1	Updated Model	2-3
Figure 2.2	Model A and RDI Model	2-6
Figure 2.3	Example of Dry Weather Calibration (Site MH5302)	2-10
Figure 2.4	Example of Wet Weather Calibration (Site MH5302)	2-14

Abbreviations

ADWF	Average Dry Weather Flow
BWF	base wastewater flow
City	City of Renton
CIWEM	Chartered Institution of Water and Environmental Management
DWF	dry weather flow
FRC	fast response corresponding
gpd/ac	gallons per day per acre
I/I	Inflow and Infiltration
LRWWMP	Long Range Wastewater Management Plan
mgd	million gallons per day
PE	Person Equivalent
RDI	Rainfall Dependent Infiltration
RDII	Rainfall Derived Infiltration and Inflows
SRC	slow response corresponding
TM	Technical Memorandum
TP	treatment plant
UDG	Urban Drainage Group
WaPUG	Wastewater Planning Users Group
WWF	wet weather flow

Technical Memorandum 2

MODEL DEVELOPMENT AND CALIBRATION

This Technical Memorandum (TM) describes the City of Renton's (City) collection system infrastructure, as well as the update and calibration of the City's collection system hydraulic model.

2.1 Hydraulic Model Overview

A wastewater collection system model is a simplified representation of the real sewer system. Wastewater system models can assess the conveyance capacity of the collection system. The model can be used to size new infrastructure. In addition, sewer system models can perform "what if" scenarios to assess the impacts of future developments and land use changes. The City's collection system hydraulic model was updated and expanded using a multi-step process utilizing data from a variety of sources. This section summarizes the hydraulic model development process, including a description of the modeled collection system, the hydraulic model elements, and the model creation process.

2.1.1 Hydraulic Modeling Software

The City's system hydraulic model was developed using the Mike Urban hydraulic modeling software package, developed by DHI. The latest version (2016) of Mike Urban was used for the hydraulic model update. More information about the modeling software can be found in the Mike Urban Collection Systems Guide¹. The Mike Urban model is a full pipe model including all of the City's GIS. The hydraulic modeling engine used within the Mike Urban software package is MOUSE, which is widely used throughout the world for planning, analysis, and design related to stormwater runoff, combined sewers, sanitary sewers, and other drainage systems.

2.1.2 Elements of the Hydraulic Model

The following provides a brief overview of the various elements of the hydraulic model and the required input parameters associated with each. Figure 2.1 shows the hydraulic model, and associated infrastructure described above.

- **Junctions:** Sewer manholes, cleanouts, and other locations where pipe sizes change or where pipelines intersect are represented by junctions in the hydraulic model. Required inputs for junctions include rim elevation, invert elevation, diameter, and surcharge depth (used to represent pressurized systems). Junctions are also used at locations where flows are split or diverted between two or more downstream links.
- **Pipes:** Gravity sewers and force mains are represented as pipes in the hydraulic model. Input parameters for pipes include length, friction factor (e.g., Manning's n for gravity

¹ Collection System Guide, Mike Urban 2016.

mains, Hazen Williams C for force mains), invert elevations, diameter, shape, and whether or not the pipe is a force main.

- **Storage Nodes:** For sewer system modeling, storage nodes typically are used to represent pump station wet wells (although other storage basins, etc., can be modeled as storage nodes). Input parameters for storage nodes include invert elevation, wet well depth, and wet well cross section or a depth area relationship.
- **Pumps:** Pumps are included in the hydraulic model as links. Input parameters for pumps include pump curves and operational controls.
- **Outfalls:** Outfalls represent areas where flow leaves the system. For sewer system modeling, an outfall typically represents an overflow point or the connection to the influent pump station at a wastewater treatment plant (TP).
- **Rain Gauges:** Rain gauges are rainfall input locations for the hydraulic model for simulation of wet weather flows (WWF) that are historical, projected, or theoretical hourly rainfall events.
- **Subcatchments:** Subcatchments represent the hydrologic units of land area whose topography and drainage characteristics direct flow into a single discharge point in the sewer system. Subcatchments can be used to route rainfall runoff to the system, using parameters that determine how much and how fast stormwater inflow and infiltration (I/I) enters the sewer system.
- **Inflows:** There are two primary flow sources that enter into the collection system, which are input through individual junctions (and storage nodes) in the model:
 - **Dry Weather.** Dry weather inflows simulate base sanitary wastewater flows and represent the average flow. The dry weather flows (DWF) can be multiplied by up to four patterns that vary the flow by month, day, hour, and day of the week (e.g., weekday or weekend). The dry weather diurnal patterns are adjusted during the dry weather calibration process to match the known daily flow fluctuations. Two diurnal patterns were developed for each basin, respectively representing weekday and weekend days (see Appendix G, TM 1).
 - **Rainfall Derived Infiltration and Inflows (RDII).** RDII are flows into the collection system originating from rainfall. Several models are available in Mike Urban to capture these effects. The models have a number of parameters that are adjusted during the wet weather calibration process (see Section 2.2.3) to model the flows into the collection during different storm events.

2.2 Hydraulic Model Expansion and refinement

This section describes the multi-step process used to update the hydraulic model using recent GIS data information and other sources, such as field surveys and as-built drawings.

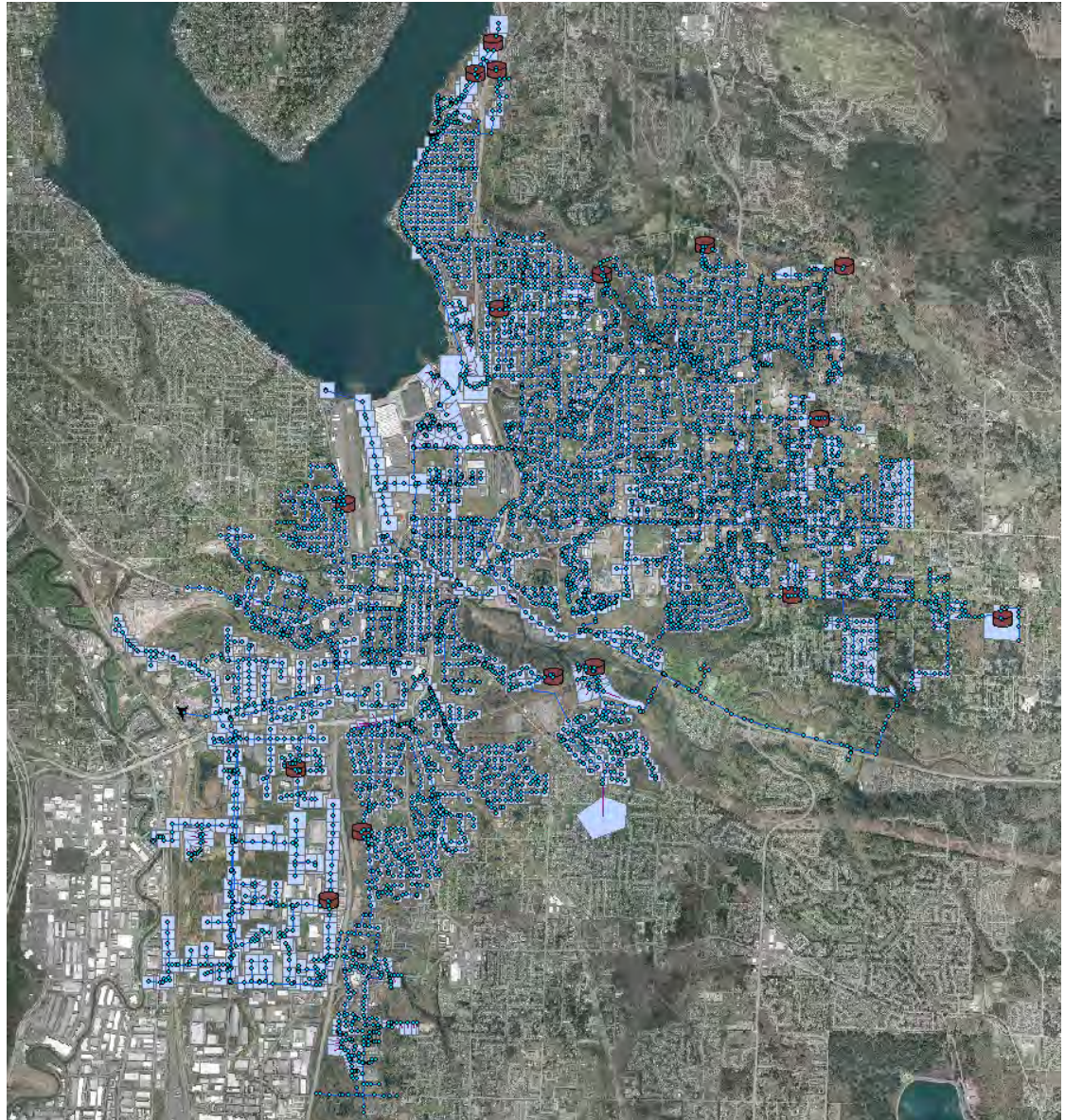

Figure 2.1 Updated Model

2.2.1 Model Update Process

The City's hydraulic model combines information on the physical and operational characteristics of the wastewater collection system, and performs calculations to solve a series of mathematical equations to simulate flows in pipes. The model update focused on adding new infrastructure and updating diameter and material information based on the City's GIS.

- Step 1: The City's GIS shape files for the wastewater collection system were obtained.
- Step 2: The GIS data was reviewed and formatted in Excel to allow easy update of the Mike Urban modeling platform.
- Step 3: The City's GIS data was separated based on existing, modeled pipes to be updated to match GIS data and new pipes to import into the model.

- Step 4: The collection system pipeline data and facility data were imported into the modeling software and verified. Physical and operational data for the City's wastewater collection facilities was not available from the GIS data. This type of data, such as wet well dimensions, pump stations, and other special features, was verified manually based on calibration.
 - Once all the relevant data was updated and input into the hydraulic model, the model was reviewed to verify that the model data was input correctly and that the flow direction and size of the modeled pipelines were logical. Additionally, the modeled pump stations were checked to verify that they operated correctly.
 - The GIS data showed several negative slope pipes. These pipelines are listed in Attachment D. The City should field check these pipe inverts when the opportunity arises. If numerous deficiencies are predicted in the vicinity of these pipes, a field investigation may be warranted prior to developing projects to verify the system deficiency.
- Step 5: Dry weather wastewater flows were then allocated to the appropriate model junctions. Eighteen separate flow factors were used and updated for flow monitoring basins. These flows were scaled up or down, as necessary, to match the DWFs recorded during the flow monitoring period during the dry weather calibration. Unmetered basins were not updated at this time.
- Step 6: The hydraulic model contains run parameters that need to be set by the user at the beginning of the project. These include run dates, time steps, reporting parameters, output units, and flow routing method. Once the run parameters were established, the model was debugged to ensure that it ran without errors or critical warnings.

2.2.2 Wastewater Flow Allocation

Defining the quantity of dry weather wastewater flows generated by a municipality and how the flows are distributed throughout the collection system is an important component of the hydraulic modeling process. Various techniques can be used to assign wastewater flows to individual model junctions, depending on the type of data that is available. Adequate estimates of the volume of sanitary wastewater flows are important in maintaining and sizing sewer system facilities, both for present and future conditions. Baseline wastewater flows were allocated (assigned to specific nodes) in the hydraulic model based on land use data provided by the City and wastewater flow coefficients developed previously (these are described in detail in TM01).

The flow coefficients for specific land use category were used to estimate an average DWF, as described below:

- Step 1: The City's service area was broken up into 5,478 catchments based on tax parcels and land use. Figure 2.1 shows the catchments developed to allocate flows in the hydraulic model, and the entirety of the hydraulic model. Each catchment represents the geographic area that contributes flows into a single model node (i.e., trunk system manhole).
- Step 2: The baseline flows were calculated for each loading polygon using a Person Equivalent (PE). The PE for each catchment was based on zoning and employment data developed in Stantec's 2015 Model Update Report, Appendix F, and additional information can be found in Chapter 4 of the Long Range Wastewater Management

Plan (LRWWMP). The total PE for each flow monitoring basin was determined based on upstream catchments. Using the total PE in each basin, a flow factor was developed for every basin to relate PE to Average Dry Weather Flow (ADWF) (see Appendix G, TM 1 for additional detail).

- Step 3: The hydraulic model's load allocation assigned the calculated average DWF to the appropriate node in the sewer system model.
- Step 4: The allocated flows were adjusted as necessary during the DWF calibration process (see Section 2.3.3) to closely match the actual measured DWFs recorded during the flow monitoring period.

2.2.3 Inflow and Infiltration: Time-Area Model A and RDI

Mike Urban has several modules to estimate the wet weather I/I in each basin. For this study, the MOUSE Time-Area Model A (Inflow) and Rainfall Dependent Infiltration (RDI) methods were chosen to model I/I respectively. The MOUSE Model A includes three primary factors including: time of concentration, a reduction factor representing flow losses, and an initial loss. The model also includes curves representing basin rain response. Basin rain response is essentially how fast flow from different parts of the catchment basin reaches the collection system.

The infiltration component of the RDI flow comes from three sources, conceptually represented by different storage zones through the soil column. Figure 2.2 shows the conceptual RDI model, from DHI (2016). The three sources of flow that enter the collection system as RDI are Overland Flow that enters the system rapidly after a storm, Interflow with a medium response time, and Base Flow with a slower response, which is different than the sanitary Base Flow coming from wastewater customers.

The volume of water stored in each zone, the response time, and how water moves between the zones are described by a series of related equations. The equations include 19 parameters that are not directly measurable and must be determined through model calibration. An evapotranspiration term is included to simulate drying of the zones. Attachment C present the resulting parameters after model calibration.

Two important I/I parameters are the areas of "connected pervious" and "connected impervious" land contributing flow to each basin's collection system. These areas represent the equivalent area of land accumulating rainfall that produce the WWF measured at the downstream flow meter. For example, if a flow meter measures a fast response to a storm event, there may be a lot of impervious land that is accumulating rainfall and contributing surface runoff to the collection system. Connected pervious land represents the equivalent amount of land absorbing rainfall and slowly contributing WWF to the collection system when the ground is saturated.

The RDI and Model A flow components combine to create a continuous hydrograph of rainfall derived flows (RDII) for each basin from each storm event. Often during wet periods, additional storms occur while tailing components of the preceding storm are still entering the system, creating complex hydrographs.

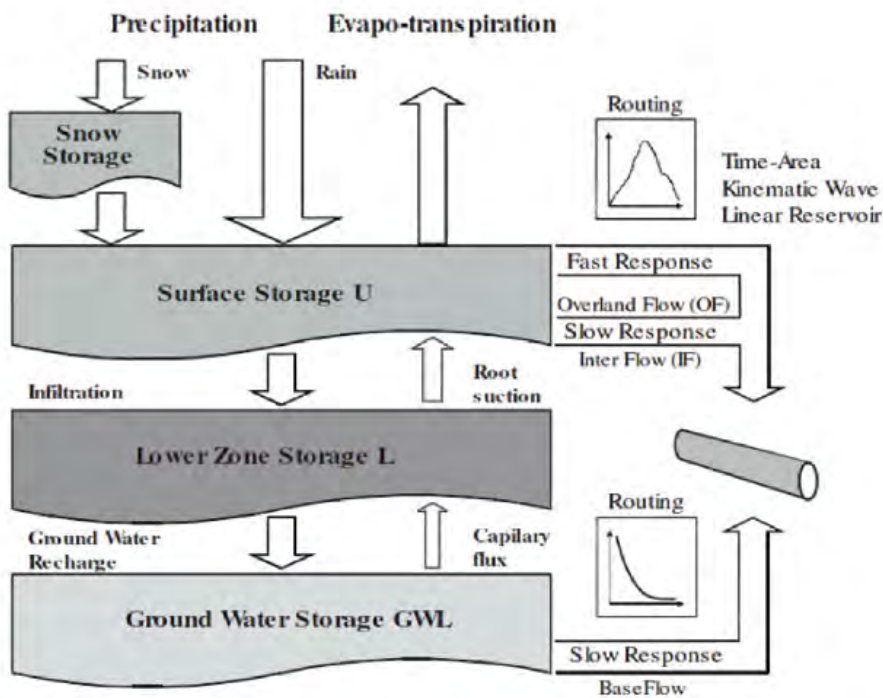
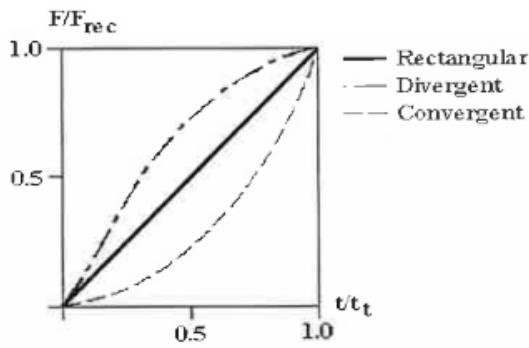
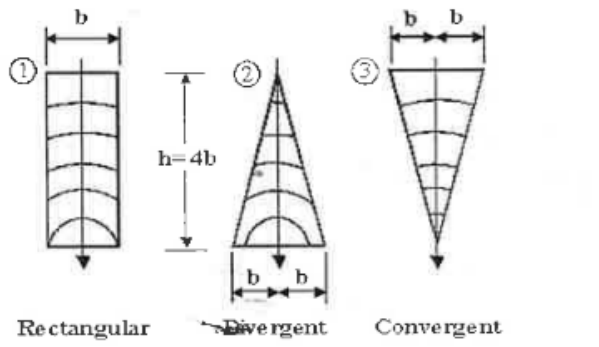

Figure 2.2 Model A and RDI Model

2.3 Hydraulic Model Calibration

Hydraulic model calibration is a crucial component of the hydraulic modeling effort. Calibrating the model to match data collected during the flow monitoring program ensures the most accurate results possible. The calibration process consists of calibrating to both dry and wet weather conditions.

For this project, both dry and wet weather monitoring were conducted at the 18 metering sites presented in Appendix G, TM 1. DWF calibration ensures an accurate depiction of base wastewater flow (BWF) generated within the study area. WWF calibration consists of calibrating the hydraulic model to a specific storm event or events to accurately simulate the peak flow and volume of I/I into the sewer system. The amount of I/I is essentially the difference between the WWF and DWF components.

2.3.1 Calibration Standards

The hydraulic model was calibrated in accordance with international modeling standards. The Urban Drainage Group (UDG), formerly known as Wastewater Planning Users Group (WaPUG), a section of the Chartered Institution of Water and Environmental Management (CIWEM), has established generally agreed upon principles for model verification. The dry weather and wet weather calibration focused on meeting the recommendations on model verification contained in the "Code of Practice for the Hydraulic Modeling of Urban Drainage Systems," published by the CIWEM UDG², as summarized below.

2.3.1.1 Dry Weather Calibration Standards

Dry weather calibration should be carried out for two dry weather days and the modeled flows and depths should be compared to the field-measured flows and depths. Both the modeled and field-measured flow hydrographs should closely follow each other in both shape and magnitude.

In addition to the shape, the flow hydrographs should also meet the following criteria as a general guide:

- The timing of flow peaks and troughs should be within 1 hour.
- The peak flow rate should be within the range of ± 10 percent.
- The volume of flow (or the average rate of flow) should be within the range of ± 10 percent. If applicable, care should be taken to exclude periods of missing or inaccurate data.

2.3.2 Wet Weather Calibration Standards

For each meter, three separate storms need to be run through the model. For at least two storms out of the three events from the flow monitoring period, the model-simulated flows and depths should match the field-measured flows and depths within the accepted criteria. The modeled and field flow hydrographs for the calibration storms should closely follow each other in both shape and magnitude, until the flow has substantially returned to DWF rates.

² UDG, Code of Practice for the Hydraulic Modelling of Urban Drainage Systems, 1st Edition CIWEM 2017 www.ciwem.org.

In addition to the shape, the flow hydrographs should also meet the following criteria as a general guide:

- The timing of the peaks and troughs should be similar with regard to the duration of the events.
- The peak flow rates at significant peaks should be in the range of +25 percent to -15 percent and should be generally similar throughout.
- Modeled volume of flow should be within +20 percent to -10 percent of measured volume of flow.
- The depth of surcharge should be in the range of +20-inches to -4-inches.
- The unsurcharged depth should be within the range of \pm 4-inches.

The UDG recommends that for wet weather calibration, the use of a single calibration period incorporating a number of rainfall events should be considered whenever possible. In other words, if the flow monitoring program captured several back to back storms, it may be preferable to use the back to back storms events as the calibration storms, as opposed to calibrating to two separate storms that have occurred weeks or months apart.

Model calibration simulations should be run for a duration long enough that the I/I response is no longer apparent in the measured data.

2.3.3 Dry Weather Flow Calibration

2.3.3.1 Dry Weather Calibration Process

The DWF calibration process consists of several elements:

- Divide the system into areas tributary to each flowmeter. The first step in the calibration process was to divide the City into flow meter tributary areas. Eighteen tributary areas were created, one for each flowmeter from the flow monitoring program. A map showing the locations of each flow monitoring site and their associated tributary area is provided in Appendix G, TM 1, along with a schematic of the flow meters.
- Define flow volumes within each area. The next step was to define the flow volumes within each area, which was accomplished in the flow allocation step (see Section 2.2.2).
- Create diurnal patterns to match the temporal distribution of flow. A diurnal curve is a pattern of hourly multipliers that are applied to the base flow to simulate the variation in flow that occurs throughout the day. Two diurnal curves were developed for each flow monitoring tributary area, one representing weekday flow and one representing weekend flow. The diurnal patterns were initially developed based on the flow monitoring data and adjusted as part of the calibration process until the model-simulated flows closely matched the field-measured flows. Figure 2.3 shows the calibrated weekday and weekend diurnal patterns for the area tributary to Meter Site MH5302. Similar diurnal curves were developed for each of the meters and its tributary area. These additional curves are available in Attachment E.

2.3.3.2 Dry Weather Calibration Results

Table 2.1 provides a summary of the DWF calibration using the average and daily peak flow results for both weekday and weekend conditions. As shown on Table 2.1, with a few exceptions, the model-simulated average and peak flows for both weekday and weekend DWF were all

within 10 percent. In general, the percent difference between the overall modeled and measured DWF ranged between -8.7 and 9.6 percent, with most differences being less than 5 percent.

Attachment F contains a detailed DWF calibration summary sheet for each of the 18 metering sites. Each calibration sheet provides plots that compare the model-simulated and field-measured flow data for both weekday and weekend conditions. An example of the dry weather calibration for Meter Site MH5302 is shown on Figure 2.3.

Modeled level results were also checked against the recorded flow monitoring data at each of the 18 sites. All sites meet the DUG criteria and are within 4 inches during uncharged conditions. Of the 18 sites, ten of the flow meters were located on segments with steep slopes causing supercritical hydraulic conditions. These supercritical conditions are difficult to measure in the field, as well as simulate in the model. During calibration, modeling parameters, such as the node headlosses, were adjusted to meet calibration criteria. However, the model remains highly sensitivity at these sites to changes in level and flow changes.

There is good overall correlation of the field-measured data to the model output results. All 18 of the sites are within a 10 percent range of both peak and volume, and therefore meet CiWEM criteria. Therefore the model was considered calibrated for DWF.

Table 2.1 Dry Weather Flow Calibration Results

Flow Meter ID	Weekday Flow Volume Difference (%)	Weekday Peak Flow Difference (%)	Weekday Max Level Diff (in)	Weekend Flow Volume Difference (%)	Weekend Peak Flow Difference (%)	Weekend Max Level Diff (in)
MH0166	-1.3	-6.4	0.24	7.8	-1.7	0.45
MH0286	0.7	0.6	0.76	2.1	1.5	0.78
MH0537	-0.7	-3.1	0.47	-0.7	-7.0	0.47
MH1360	6.1	2.3	1.55	2.4	-3.1	1.57
MH1763	0.9	1.7	3.59	-5.6	-6.4	3.67
MH2116	-8.5	0.1	1.54	-7.1	2.9	1.83
MH2171	-0.4	-1.7	1.30	-0.5	-1.2	0.76
MH2252	0.2	-1.0	0.21	-3.4	-4.1	0.23
MH2999	-8.4	6.5	0.75	-4.4	-0.9	0.69
MH3216	-2.4	-3.3	0.38	5.0	4.3	0.57
MH3625	0.4	-7.7	0.87	-9.1	-5.4	1.20
MH4628	1.4	1.1	0.28	-3.4	-3.7	0.32
MH4646	0.0	-0.1	3.72	0.0	-0.2	3.74
MH5302	-8.7	-1.7	2.16	-8.5	9.8	2.43
MH5505	0.6	1.3	0.56	-0.1	0.5	0.57
MH5519	1.7	1.5	0.91	9.1	8.9	1.05
MH6041	-3.5	-4.5	1.52	9.6	9.0	1.62
MH6704	3.6	2.7	1.24	-8.6	-9.7	1.21

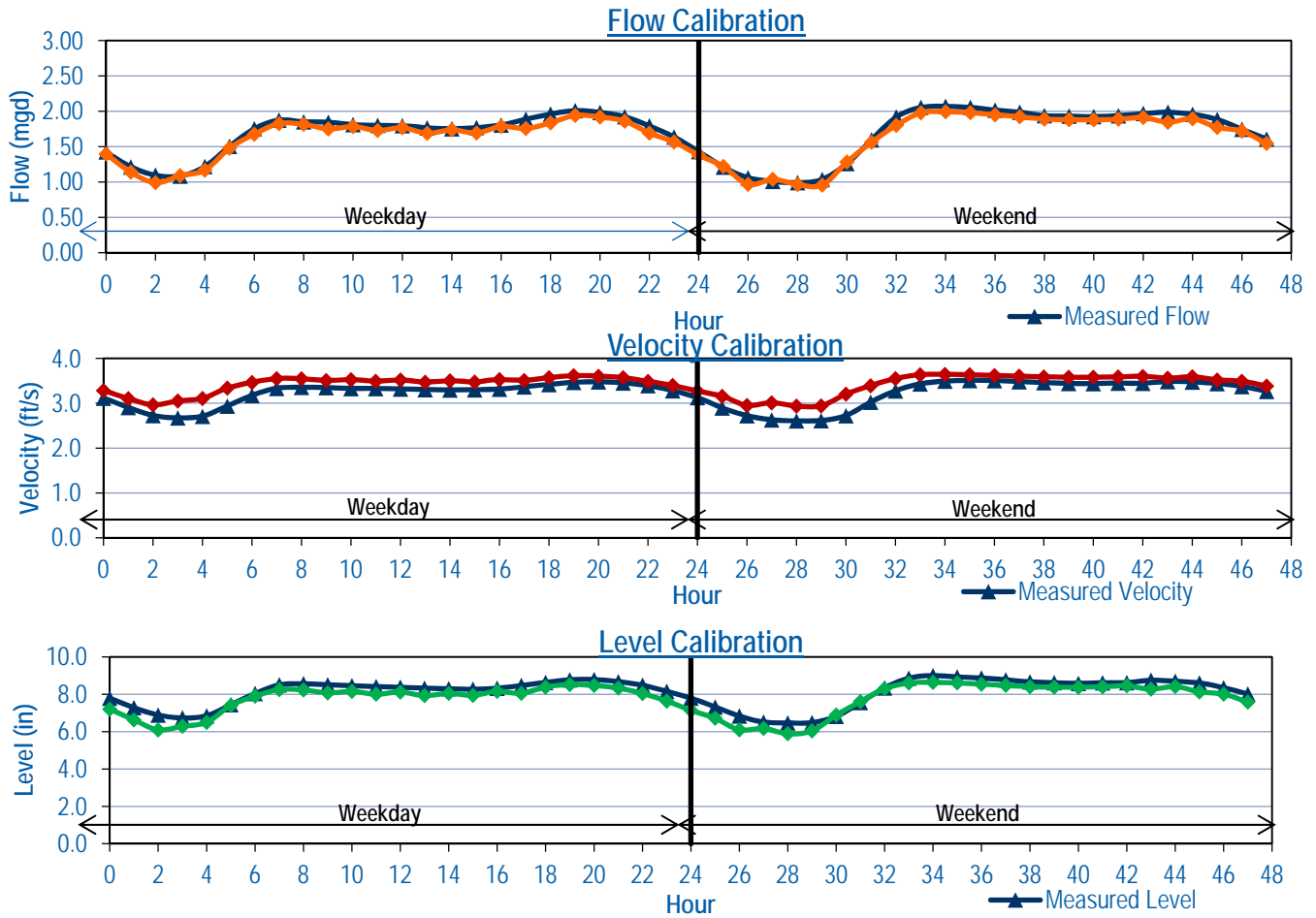

Figure 2.3 Example of Dry Weather Calibration (Site MH5302)

2.3.4 Wet Weather Flow Calibration

2.3.4.1 Wet Weather Calibration Process

The WWF calibration enables the hydraulic model to accurately simulate I/I entering the collection system during a large storm. As outlined below, the WWF calibration process consists of several elements:

- Identify calibration rainfall events. The WWF calibration process consists of running model simulations of historic rainfall events based on data collected as part of a system flow monitoring program. The goal of any WWF monitoring program is to capture and characterize a system's response to a significant rainfall event, preferably during wet antecedent moisture conditions.
- The selection of a particular calibration storm or group of storms is based on a review of the flow and rainfall data. There is a good range of different event types available for the different meters. Major events were identified as part of Chapter No. 2. This section refines the analysis and shows the different storms selected for calibration for all meter sites. Data was recorded between 2017 and 2018.

- Define RDII tributary areas. For the WWF calibration, RDII flows are added to the DWF. The model calculates two types of response: a slow response corresponding (SRC) mainly to infiltration and a fast response corresponding (FRC) mainly to direct inflow. Impervious area, which is the fraction of the catchment considered to contribute to FRC runoff, and RDI Area, which is the fraction of the total catchment area that contributes to the SRC runoff component are two major model-specific data in the model calculation of WWFs. These values were initially set based on engineering judgment, as well as the previously used values, and then adjusted until the model-simulated flows (both peak flows and total volume) matched closely with the field-measured flows.
- Create I/I parameter database and modify to match field-measured flows. The main step in the WWF calibration process involves adjusting both Model A and RDI parameters for each flow monitoring tributary area. The most important parameters were described in Section 2.2.3 and Attachment C summarizes all calibrated parameters by flow monitoring site. As with the dry weather calibration, the wet weather calibration process compared the meter data with the model output. Comparisons were made for average and peak flows as well as the temporal distribution of flow until flows returned to their baseline levels. According to the UDG, a hydraulic model is generally considered to be satisfactorily calibrated to WWF conditions if the modeled peak flows are within +25 percent to -15 percent of the field-measured data, and if the average modeled flows are within +20 percent to -10 percent of the field-measured data.
- Adjust model variables to match field-measured velocity and flow depths. Once the model-simulated flows matched the field-measured flows within the acceptable limits, the model-simulated velocity and flow depth were compared to the field-measured velocity and flow depth. Adjustments were made to various model parameters until the modeled and measured velocity and depth closely matched one another. The primary varied parameters for this process are pipeline roughness (Manning's n), although other parameters can also be adjusted as calibration results are generated. Sediment buildup and movement in the pipe will also influence the level and depth, but these are very difficult to quantify and can change frequently, therefore they are not included in the calibration.
 - Manning's roughness coefficients, or n values, have industry accepted ranges based on a number of variables. Roughness coefficients can increase over time depending on the construction methods, installation quality, system maintenance, and other environmental factors. Certain factors can result in roughness coefficients that differ from the typical range. These could include joint misalignment, cracks, and debris (e.g., root intrusion, etc.) that lead to increased turbulence in a pipe and an increase in the apparent Manning's n factor.
 - If the model is unable to reasonably match the field-measured flow depth and velocity within the acceptable range of Manning's roughness coefficients, further investigation should be conducted to help determine the cause of the discrepancy. Some issues that could cause such a discrepancy can include errors in the slope or diameter of a pipeline, downstream blockages, pipeline sags, and, in some cases, influences from downstream pump station operations.

2.3.4.2 Wet Weather Calibration Results

Attachment H contains a detailed WWF calibration summary sheet for each of the 18 meter sites. Each calibration sheet provides plots that compare the model-simulated and field-measured flow, velocity, and level data for the calibration storms. An example of the wet weather calibration for Meter Site MH5302 is shown on Figure 2.4.

Table 2.2 provides a summary of the WWF calibration using the average and peak flow results. As shown on Table 2.2, the model-simulated average and peak flows at 16 of 18 meter sites were within the acceptable tolerances for the calibration storms, and therefore the model was considered calibrated and ready to use for capacity analysis purposes.

Table 2.2 Wet Weather Flow Calibration Results

Flow Meter ID	Pipe Dia. (in)	Storm 1			Storm 2			Storm 3		
		Vol. Flow (%)	Peak Flow (%)	Level Diff. (ins)	Vol. Flow (%)	Peak Flow (%)	Level Diff. (ins)	Vol. Flow (%)	Peak Flow (%)	Level Diff. (ins)
MH0166	12	31.1	-1.5	5.1	-3.0	11.9	21.0	15.4	-0.9	7.4
MH0286	10	7.2	-1.8	1.5	0.1	-11.9	1.7	-7.8	-25.8	1.8
MH0537	8	10.1	2.0	0.2	5.2	-6.6	0.9	17.2	13.3	1.1
MH1360	10.75	18.1	9.7	5.7	-12.8	7.2	5.8	15.1	2.5	6.0
MH1763	15	13.0	13.7	6.2	-38.9	-15.0	6.4	-0.3	-5.0	5.3
MH2116	14.5	-	-	-	-9.5	-12.6	6.0	3.7	7.3	4.0
MH2171	11.25	6.8	10.9	3.5	-6.7	7.7	2.4	17.3	19.5	3.8
MH2252	18	-2.5	-5.8	1.6	-9.4	12.2	1.6	8.1	58.3	2.0
MH2999	8	11.0	-10.9	1.3	11.3	1.8	1.3	16.8	7.0	1.4
MH3216	7.38	18.8	-4.4	2.9	-11.3	25.2	1.7	13.5	47.8	1.9
MH3625	12	4.7	5.0	3.1	-14.7	-6.1	3.8	-1.7	-8.5	3.7
MH4628	10.38	10.4	3.5	2.2	-21.2	15.0	2.6	10.9	-1.6	2.3
MH4646	8	-1.9	-6.6	5.4	-18.3	-19.7	5.4	-2.2	1.9	5.6
MH5302	14	-4.3	-8.7	3.8	-7.9	6.7	4.5	-1.6	0.8	4.3
MH5505	10	6.6	-1.9	1.5	-9.5	6.3	1.2	-2.2	-14.7	2.8
MH5519	10.25	12.2	33.1	1.5	10.9	24.0	1.4	9.8	1.3	21.3
MH6041	8	-14.5	-8.9	2.6	16.5	19.7	2.6	39.3	140.3	3.5
MH6704	12	-8.4	-19.1	1.9	16.7	21.8	2.0	15.2	3.0	1.9

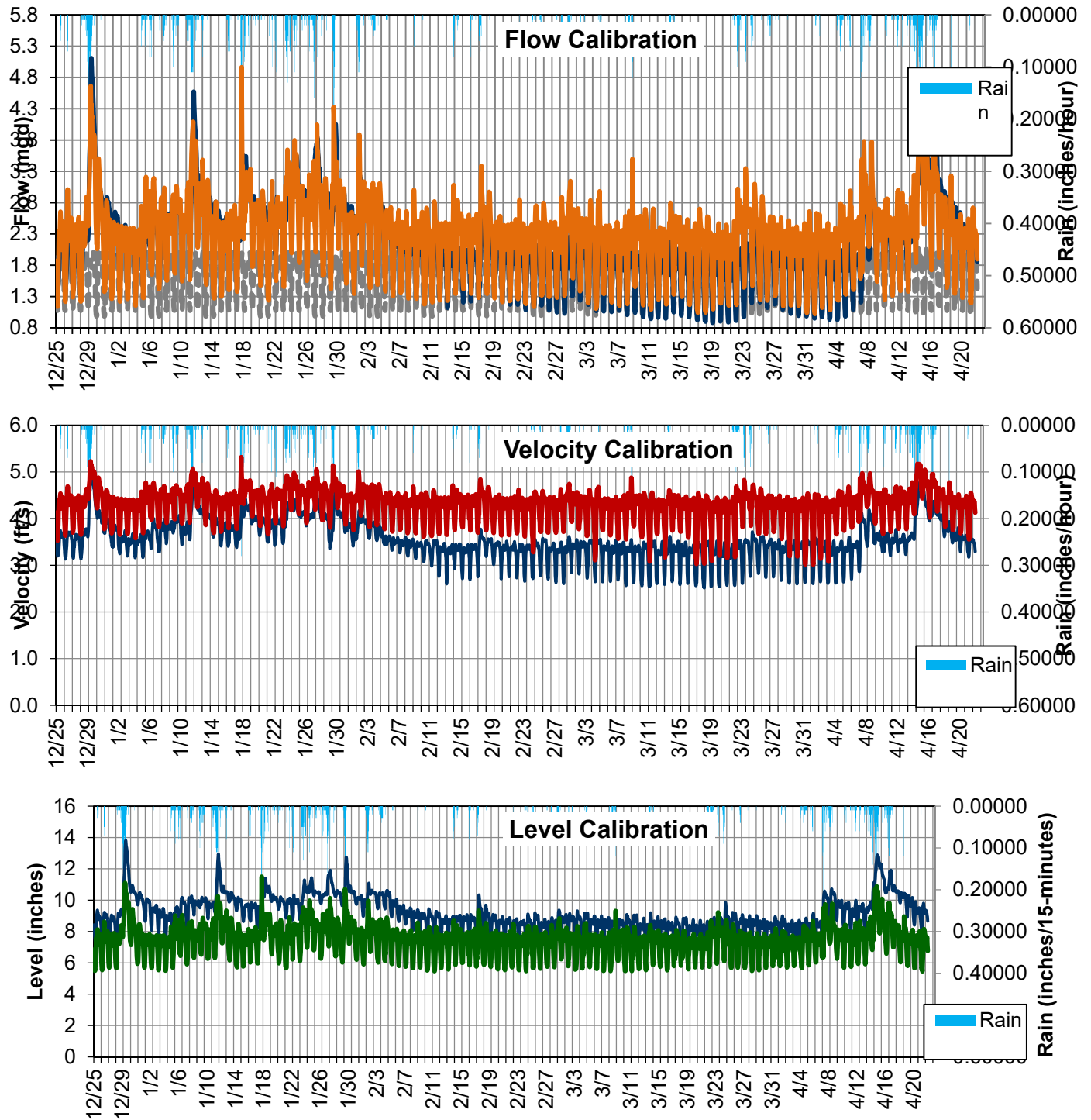

Figure 2.4 Example of Wet Weather Calibration (Site MH5302)

2.3.4.3 Wet Weather Calibration Discussion

Every meter data was compared to three storms recorded during the flow monitoring period for calibration, with the exception of MH2116 which had two, because the meter failed to record data during the initial storm event.

Of the 18 meters, 16 had two or more storm events response within calibration standards for flows. Of the 18 meters, 12 met the level calibration standard of a maximum difference of four inches. As discussed previously in the dry weather calibration section, sites with super critical remain sensitive to flow and level changes in the hydraulic model.

The following are discussions on specific sites:

- Site MH3216 only reached calibration standards for one of the three storms. In general the model could not match the peak flows measured for the first two upfront storm events. The City's collection system showed a more significant rainfall response in the first half of the flow monitoring period. Note, the flow monitoring was stopped for a two week period in January, and following this the meter showed less response than before the period of inactivity. Calibration parameters were calibrated to match Storm 1 response, so the hydraulic model is more conservative.
- Site MH6041 also only met calibration standards for one of the three calibration storms. Similar to Site MH3216, MH6041 had significant changes in rainfall response throughout the flow monitoring period. Storm 1 occurred in December and caused significant I/I response in the collection system, while Storms 2 and 3 showed almost no response in the later part of the season. The change in rainfall response made it difficult to match across the season, for this reason conservative parameters were used and the hydraulic model was calibrated to Storm 1.

As a result of calibration, I/I metrics were estimated from the model results for existing conditions at the 18 flow monitoring sites. Results show a large variation of I/I response throughout the system, from 12 gallons per day per acre (gpd/ac) to 13,400 gpd/.

2.3.5 Hydraulic Model Calibration Summary

Calibration of the City's hydraulic model was a multi-step process that involved comparing model-simulated flow to the actual field-measured data for both dry and wet weather conditions. Results indicated that the model correlated well with the field-measured data for flows. All sites met the DUG standards for ADWF. PWWF calibration was achieved at 16 of the 18 meter sites used for model calibration, which is typical for this level of calibration. This provides a high level of confidence in the model's accuracy such that the model can be considered calibrated and ready to use for subsequent capacity analysis.

Attachment C
RDII PARAMETERS

Table 1 Connected Basin Area

Basin	Area (acres)	Connected Impervious (acres)	Connected Pervious	Total Connected	Total Connected
			(acres)	(acres)	(%)
MH0166	195.7	18.1	9.8	27.9	14.3%
MH0286	374.5	0.4	1.9	2.2	0.6%
MH0537	904.8	1.8	18.1	19.9	2.2%
MH1360	757.8	2.3	47.7	50.0	6.6%
MH1763	425.0	3.0	19.6	22.5	5.3%
MH2116	418.6	8.8	79.1	87.9	21.0%
MH2171	251.1	5.5	23.9	29.4	11.7%
MH2252	760.5	16.7	47.1	63.9	8.4%
MH2999	391.5	2.0	32.3	34.3	8.8%
MH3216	46.0	0.0	2.1	2.1	4.5%
MH3625	643.1	6.4	20.6	27.0	4.2%
MH4628	187.7	7.5	33.8	41.3	22.0%
MH4646	173.4	0.5	3.1	3.6	2.1%
MH5302	698.5	6.3	52.4	58.7	8.4%
MH5505	224.9	4.0	15.5	19.6	8.7%
MH5519	47.6	0.0	2.5	2.5	5.3%
MH6041	122.7	0.2	9.4	9.6	7.8%
MH6704	180.0	1.2	9.7	10.9	6.1%

Table 2 Model A Parameters

Basin	Impervious	Time of Concentration	Reduction Factor	Initial Loss
	(%)	(min)		(in)
MH0166	9.25	15	0.9	0.024
MH0286	0.1	15	0.9	0.024
MH0537	0.195	15	0.9	0.024
MH1360	0.3	15	0.9	0.024
MH1763	0.7	15	0.9	0.024
MH2116	2.1	15	0.9	0.024
MH2171	2.2	15	0.9	0.024
MH2252	2.2	15	0.9	0.024
MH2999	0.5	15	0.9	0.024
MH3216	0	15	0.9	0.024
MH3625	1	15	0.9	0.024
MH4628	4	15	0.9	0.024
MH4646	0.3	15	0.9	0.024
MH5302	0.9	15	0.9	0.024
MH5505	1.8	15	0.9	0.024
MH5519	0	15	0.9	0.024
MH6041	0.17	15	0.9	0.024
MH6704	0.65	15	0.9	0.024

Table 3 RDI Parameters

Basin	Percent RDI Area (%)	Surface Storage (Umax)	Root Zone Storage (Lmax)	Overland Coefficient (CQof)	Groundwater Coefficient (Carea)	TC Overland Flow (CKof)	TC Interflow (CKif)	TC Baseflow (CKbf)	Overland Flow Threshold (Tof)	Interflow Threshold (Tif)	Groundwater Threshold (Tg)	Initial Surface Storage (U)	Initial Root Zone Moisture (L)	Initial Groundwater Depth (GWL)	Initial Overland Flow (OF)	Initial Interflow (IF)	Specific Yield (Sy)	Minimum Groundwater Depth (GWLmin)	Max GW depth causing Baseflow (GWLbf0)	GW Depth for Unit Capillary flux (GWLf1)
MH0166	5	0.5	4	0.45	1	12	360	1000	85	85	0	0.3	3	7	0	0	0.2	0	7	1
MH0286	0.5	0.5	4	0.45	1	12	360	1000	85	85	0	0.3	3	7	0	0	0.2	0	7	1
MH0537	2	0.5	4	0.3	1	10	160	1000	60	60	10	0.25	2.5	14	0	0	0.2	0	14	0.8
MH1360	6.3	0.5	8	0.3	1	10	80	1000	0	0	0	0.3	3	10	0	0	0.2	0	10	1
MH1763	4.6	0.55	6	0.25	1	7	210	1000	5	38	6	0.27	3.4	17	0	0	0.2	0	17	0.66
MH2116	18.9	0.5	4	0.35	1	7	80	2300	52	80	22	0.28	2.8	11.5	0	0	0.2	0	9	0.93
MH2171	9.5	0.48	4	0.35	1	6	165	2400	0	71	75	0.25	2.5	14	0	0	0.2	0	11	0.84
MH2252	6.2	0.3	3	0.2	1	8	790	3000	0.5	0.5	0	0.1	2.4	10	0	0	0.2	0	10	0
MH2999	8.25	0.5	4	0.2	1	7	100	3000	0	0	0	0.3	3	7	0	0	0.2	0	7	1
MH3216	4.5	0.5	4	0.9	1	8	200	2000	0	0	0	0.3	3	10	0	0	0.2	0	20	1
MH3625	3.2	0.6	4.8	0.18	1	15	340	3055	52	52	46	0.2	2	18	0	0	0.2	0	18	0.66
MH4628	18	0.5	4	0.3	1	15	100	1000	0	0	0	0.3	3	10	0	0	0.2	0	10	1
MH4646	1.8	0.6	7	0.4	1	7	20	300	60	80	10	0.4	5	10	0	0	0.2	0	10	1
MH5302	7.5	0.5	4	0.3	1	20	375	1150	0	25	0	0.3	3	10	0	0	0.2	0	10	1
MH5505	6.9	0.5	4	0.3	1	20	300	600	20	20	10	0.3	3	10	0	0	0.2	0	10	1
MH5519	5.3	0.5	4	0.6	1	6.4	260	1400	0	0	0	0.18	1.8	17	0	0	0.16	0	17	0.6
MH6041	7.65	0.8	4	0.9	1	15	600	6000	0	95	0	0.3	3	10	0	0	0.1	0	10	1
MH6704	5.4	0.5	4	0.3	1	8	400	5000	58	0	0	0.3	3	10	0	0	0.2	0	10	1

Attachment D
NEGATIVE SLOPE PIPELINES LIST

MUID	FROMNODE	TONODE	Up Level	Down Level	Diameter (ft)	Length (ft)	Slope
18611	186	RE*SINT.R18A-09	0.7	0.8	9.00	41.00	0.00
18811	188	RE*SINT.R18A-08	0.7	0.8	9.00	38.80	0.00
323413	MH1130	3234	357.6	357.7	0.67	35.05	0.00
43911	439	440	2.3	2.4	7.00	13.52	-0.01
43912	439	441	2.3	2.4	7.00	13.89	-0.01
44311	443	444	2.3	2.4	7.00	13.52	-0.01
44411	444	445	2.3	2.4	7.00	13.90	-0.01
530427511	5304275	MH5935	308.6	308.7	0.67	53.70	0.00
8111	81	RE*SINT.R18-09	0.8	0.9	6.00	27.47	0.00
GM00020	MH0470	MH1376	314.9	315.0	1.33	16.13	0.00
GM00106	MH0204	MH0203	6.2	6.3	2.00	79.02	0.00
GM00117	MH4744	MH0051	339.6	339.7	1.25	93.40	0.00
GM00269	MH0820	MH6710	325.6	326.9	0.67	181.69	-0.01
GM00318	8bend	MH3694	415.9	415.9	0.67	48.74	0.00
GM00378	MH4425	MH4463	434.0	434.0	0.67	50.04	0.00
GM00406	MH4367	MH4366	395.7	395.8	0.67	62.73	0.00
GM00506	MH0245	MH0244	2.3	2.4	1.00	54.42	0.00
GM00589	MH4366	MH4701	395.7	395.8	0.67	21.03	-0.01
GM00644	MH0285	MH0286	3.3	3.4	0.83	6.54	-0.02
GM00676	MH2239	MH2241	12.7	12.8	0.67	119.97	0.00
GM00727	MH0105	5318252	63.1	63.2	0.67	143.00	0.00
GM00757	MH0135	MH0134	21.5	21.6	1.00	64.40	0.00
GM00856	MH0526	MH2756	230.1	230.2	1.50	57.18	0.00
GM00886	MH3702	MH3636	385.4	385.4	0.67	43.68	0.00
GM01147	MH3631	MH3630	410.9	410.9	0.67	19.58	0.00
GM01258	MH3060	MH3601	411.8	411.9	0.67	49.21	0.00
GM01413	MH0460	MH0459	362.6	362.7	0.67	153.13	0.00
GM01479	MH1130	3234	357.6	357.7	0.67	35.05	0.00
GM01514	MH0839	MH0738	270.6	273.7	0.67	341.55	-0.01
GM01571	MH0520	MH0383	43.1	43.1	0.67	48.96	0.00
GM01609	MH1039	MH1040	420.1	420.2	0.67	47.36	0.00
GM01757	MH0678	MH0677	225.6	225.7	0.67	59.30	0.00
GM01797	MH0719	MH0445	21.7	21.7	0.83	38.71	0.00
GM01852	MH1064	MH1153	360.1	360.2	0.67	93.00	0.00
GM01896	MH0996	MH0995	406.7	406.8	0.67	126.24	0.00
GM01916	MH1007	MH1008	407.1	407.2	0.67	152.94	0.00
GM01922	MH1131	MH1129	363.6	363.7	0.67	86.83	0.00
GM02810	MH1862	MH1861	38.6	38.6	0.83	15.00	0.00
GM03035	MH2541	MH2539	14.4	14.4	0.50	70.34	0.00
GM03145	MH2373	MH0066	17.9	21.6	1.00	62.41	-0.06
GM03252	MH2127	MH2128	18.7	18.8	2.00	70.08	0.00
GM03254	MH2129	MH2130	18.4	18.4	2.00	50.00	0.00
GM03258	MH2133	MH2134	17.9	17.9	2.00	60.42	0.00
GM03323	MH2162	MH2161	31.6	31.7	1.00	84.99	0.00
GM03375	MH2418	MH2194	12.8	12.9	1.50	34.74	0.00
GM03787	MH3214	MH3213	142.2	142.3	0.67	157.69	0.00
GM03855	MH2907	MH2906	383.0	383.1	0.67	134.02	0.00
GM03960	MH3042	MH3034	105.8	105.9	0.67	128.45	0.00
GM04264	MH3307	MH3308	96.4	96.4	0.67	89.84	0.00
GM04664	MH4862	MH2210	307.5	307.7	0.67	86.65	0.00
GM04975	MH5053	MH5052	359.2	359.3	0.67	160.69	0.00
GM04976	MH5052	MH6825	359.2	359.3	0.83	160.43	0.00
GM04978	MH5050	MH5049	304.4	318.3	0.83	300.22	-0.05
GM04979	MH5049	MH2715	318.2	327.9	0.83	351.34	-0.03
GM05144	MH5167	MH5168	407.0	409.9	0.67	68.10	-0.04
GM05191	MH5195	MH5194	416.4	416.5	0.67	55.50	0.00
GM05245	MH5240	MH3726	319.9	322.0	0.67	134.80	-0.02
GM05417	MH5331	MH5332	28.5	28.6	1.00	89.96	0.00

MUID	FROMNODE	TONODE	Up Level	Down Level	Diameter (ft)	Length (ft)	Slope
GM05425	MH5330	MH5339	16.9	17.0	1.25	61.76	0.00
GM05478	MH2134	RE*BOERENT.RO1-36	17.8	17.9	2.00	56.61	0.00
GM05481	MH1762	RE*CEDAR2.R10-26A	52.1	55.8	1.25	50.03	-0.07
GM05760	MH5543	MH5542	150.6	150.7	0.67	138.22	0.00
GM05890	MH6259	MH5672	478.2	489.0	0.67	117.05	-0.09
GM05974	MH5738	MH5898	286.2	286.2	0.67	62.40	0.00
GM06289	MH5940	MH5943	315.9	317.2	0.67	265.23	0.00
GM06311	MH5959	MH5958	376.3	376.4	0.67	77.18	0.00
GM06618	MH6212	MH6217	390.1	390.2	0.67	195.30	0.00
GM06803	MH1638	MH1637	369.7	370.4	1.00	75.97	-0.01
GM06889	MH0924	MH0761	357.7	360.4	0.67	15.78	-0.17
GM07042	MH6360	MH6361	394.8	395.9	0.67	91.44	-0.01
GM07332	MH6612	MH6613	439.0	454.9	0.67	282.49	-0.06
GM07333	MH6613	MH6614	454.8	456.1	0.67	121.59	-0.01
GM07334	MH6614	MH6615	456.0	458.0	0.67	207.78	-0.01
GM07355	MH6626	MH6356	393.7	399.4	0.67	45.41	-0.13
Link_91	MH3090	FM0043-TEE	404.8	404.9	1.25	32.00	0.00
R18-0111	R18-01	RE*SINT.RO1-68	-2.3	-2.1	7.50	123.83	0.00
R18A-1311	RE*SINT.R18A-13	184	0.9	1.1	9.00	9.97	-0.01
RE*BOERENT.RO1-3411	RE*BOERENT.RO1-34	RE*BOERENT.RO1-33	17.2	17.2	2.00	65.37	0.00
RE*CEDAR1.R10-2511	RE*CEDAR1.R10-25	RE*CEDAR1.R10-24A	55.3	55.4	3.50	73.94	0.00
RE*CEDAR2.R10-26A11	RE*CEDAR2.R10-26A	RE*CEDAR1.R10-26	52.0	55.8	3.50	73.03	-0.05
RE*CEDAR3.R10-32A11	RE*CEDAR3.R10-32A	RE*CEDAR2.R10-32	61.5	61.6	3.50	84.06	0.00
RE*CEDAR3.R10-3611	RE*CEDAR3.R10-36	RE*CEDAR3.R10-35	62.8	62.9	3.50	110.68	0.00
RE*ESI1.RO1-01A11	1814	RE*ESI1.RO1-01	-2.3	-2.2	9.00	152.67	0.00
RE*ESI1.RO1-01B11	1735	RE*ESI1.RO1-01A	-2.3	-2.2	9.00	43.26	0.00
RE*ESI1.RO1-1811	RE*ESI1.RO1-18	RE*ESI1.RO1-17	4.0	4.1	9.00	76.23	0.00
RE*ESI1.RO1-2511	RE*ESI1.RO1-25	RE*ESI1.RO1-25A	5.9	6.0	9.00	32.09	0.00
RE*ESI1.RO1-3211	RE*ESI1.RO1-32	RE*ESI1.RO1-32A	6.8	6.8	9.00	61.79	0.00
RE*ESI2.RO2-1611	RE*ESI2.RO2-16	RE*ESI2.RO2-15A	14.0	14.1	8.00	72.17	0.00
RE*SINT.R18-0111	RE*SINT.R18-01	R18-01	-2.3	-2.2	7.50	21.63	-0.01
RE*SINT.R18-0211	RE*SINT.R18-02	RE*SINT.R18-01	-2.3	-2.2	6.00	74.93	0.00
RE*SINT.R18-0911	RE*SINT.R18-09	RE*SINT.R18-08B	0.8	0.8	6.00	73.99	0.00
RE*SINT.R18-18**	RE*SINT.R18-18	RE*SINT.R18A-21	2.7	3.2	6.00	50.90	-0.01
RE*SINT.R18A-0911	RE*SINT.R18A-09	188	0.7	0.8	9.00	106.38	0.00
RE*SINT.R18A-1211	RE*SINT.R18A-12	RE*SINT.R18A-11	1.2	1.3	9.00	26.86	0.00
RE*SINT.R18A-1311	184	RE*SINT.R18A-12	1.0	1.3	9.00	85.28	0.00
RE*SINT.R18A-1811	RE*SINT.R18A-18	439	2.3	2.4	9.00	29.97	0.00
RE*SINT.R18A-2111	RE*SINT.R18A-21	RE*SINT.R18A-20	3.1	3.2	4.50	20.25	0.00
RE*TUK.R18-20A11	RE*TUK.R18-20A	RE*TUK.R18-20	6.3	6.5	3.00	72.38	0.00

Attachment E
BASIN DIURNAL PATTERNS

MH 0166

Weekday Diurnal Pattern

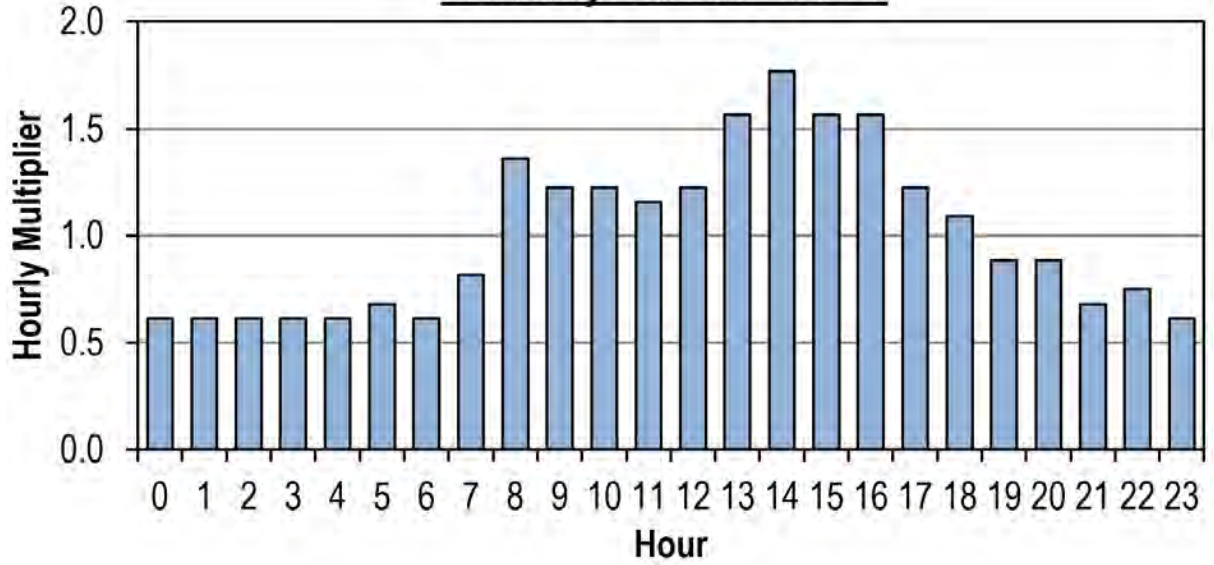

Weekend Diurnal Pattern

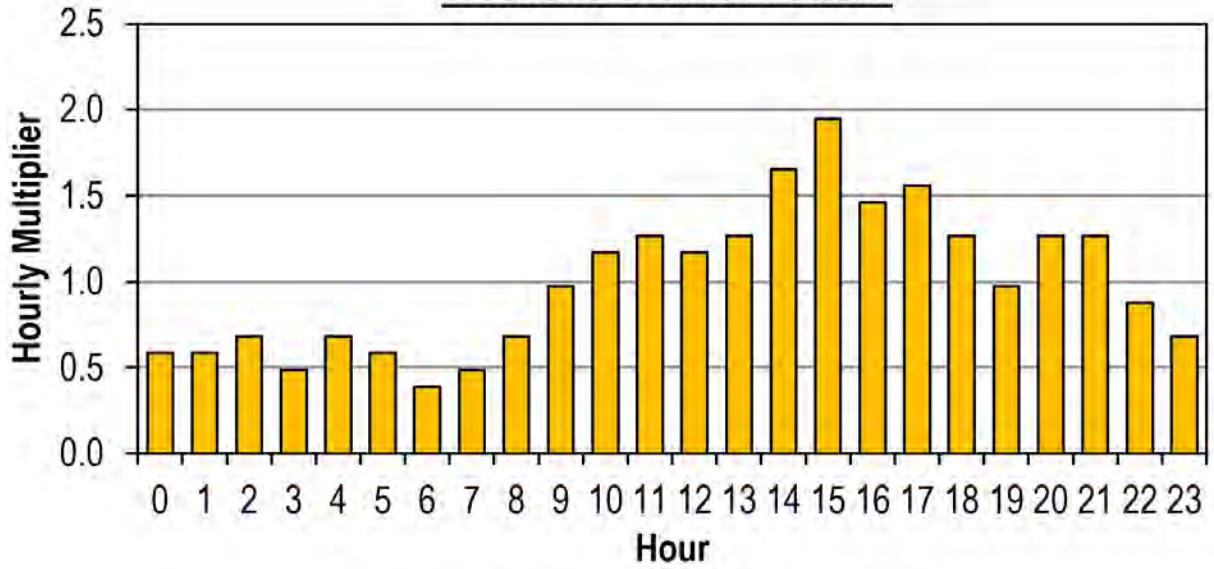

MH 0286

Weekday Diurnal Pattern

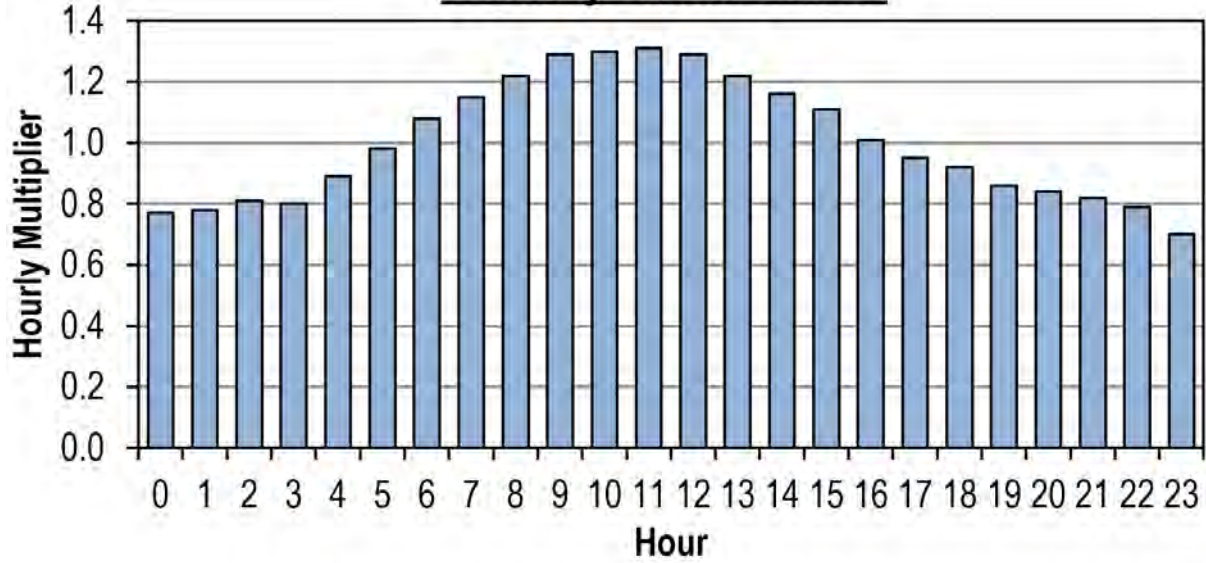

Weekend Diurnal Pattern

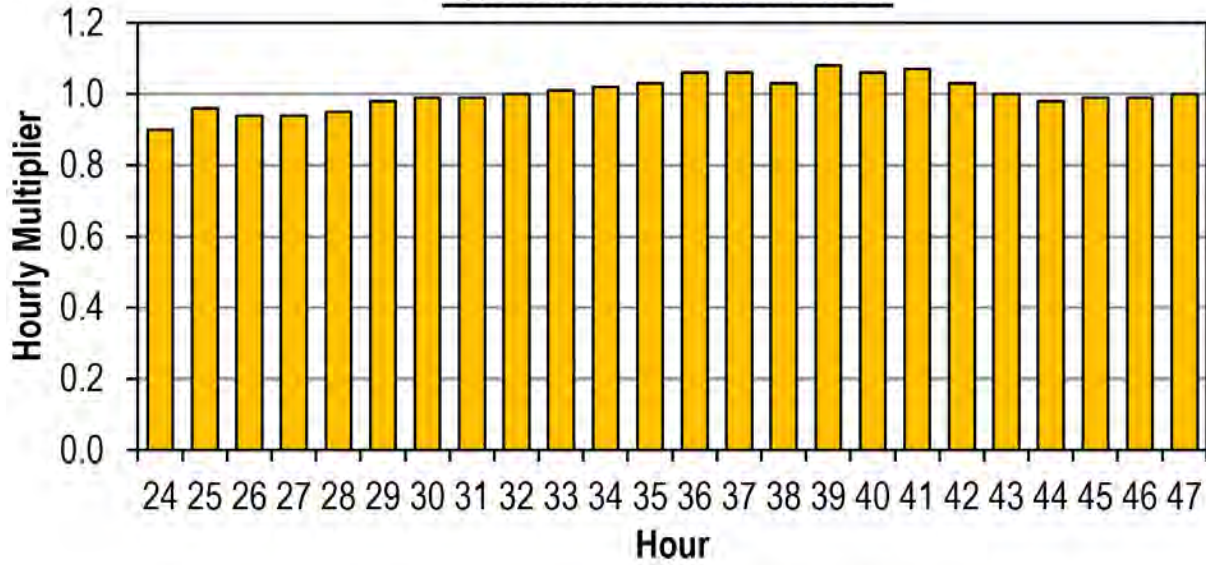

MH 0537

Weekday Diurnal Pattern

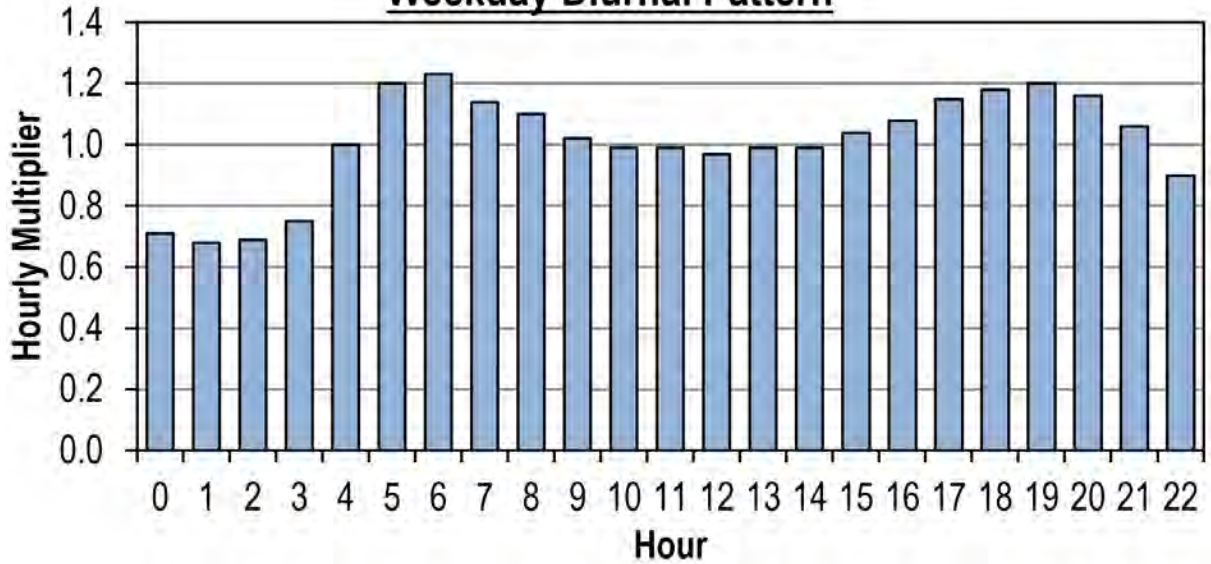

Weekend Diurnal Pattern

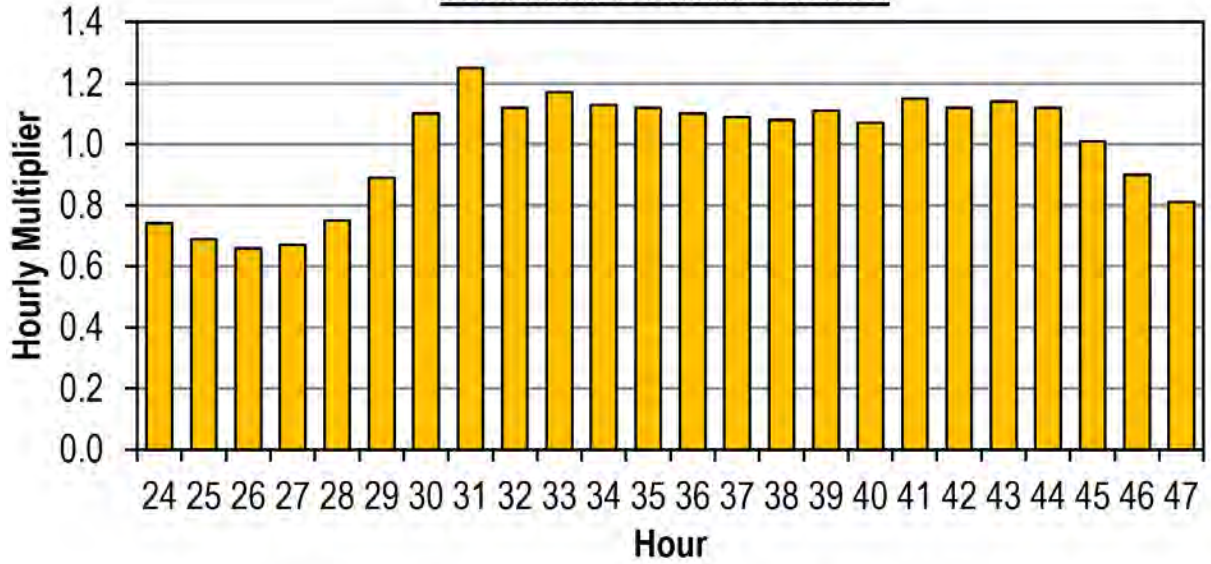

MH 1360

Weekday Diurnal Pattern

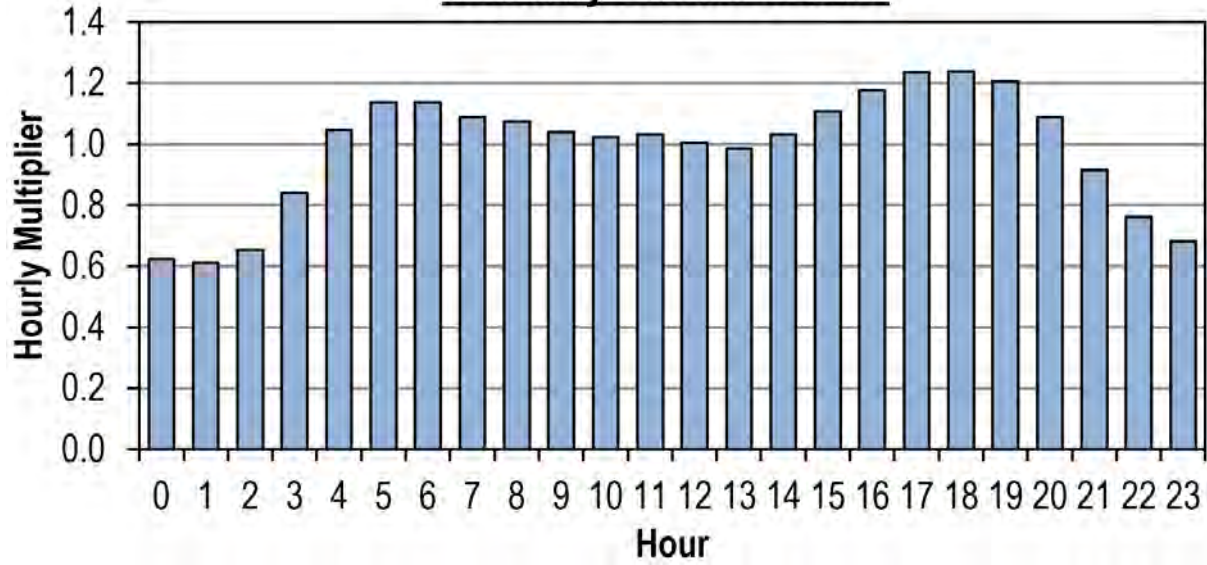

Weekend Diurnal Pattern

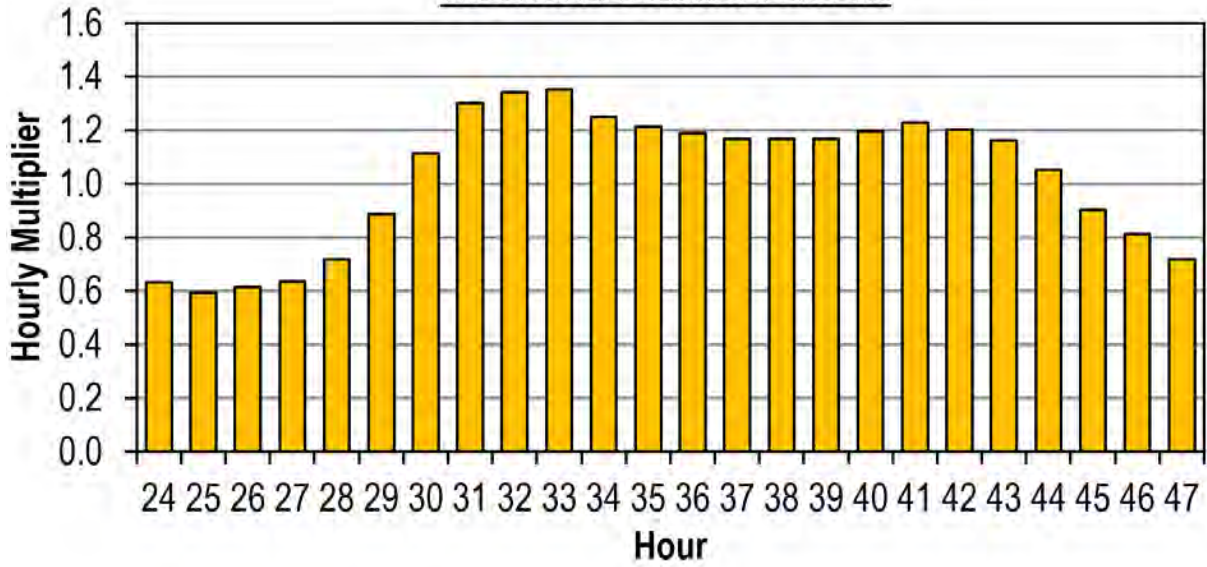

MH 1763

Weekday Diurnal Pattern

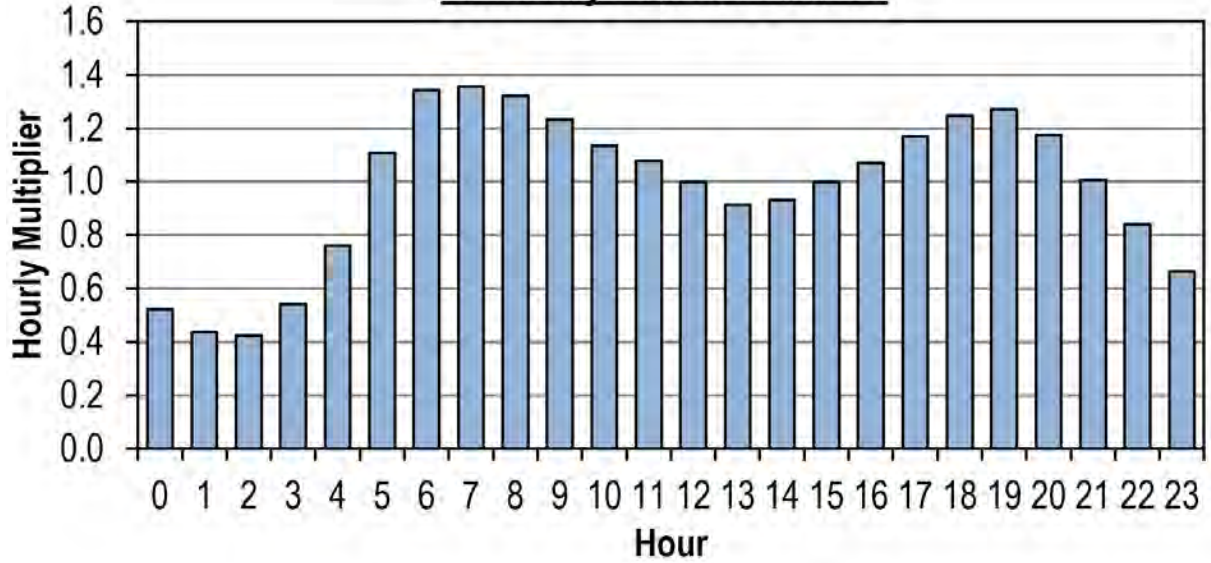

Weekend Diurnal Pattern

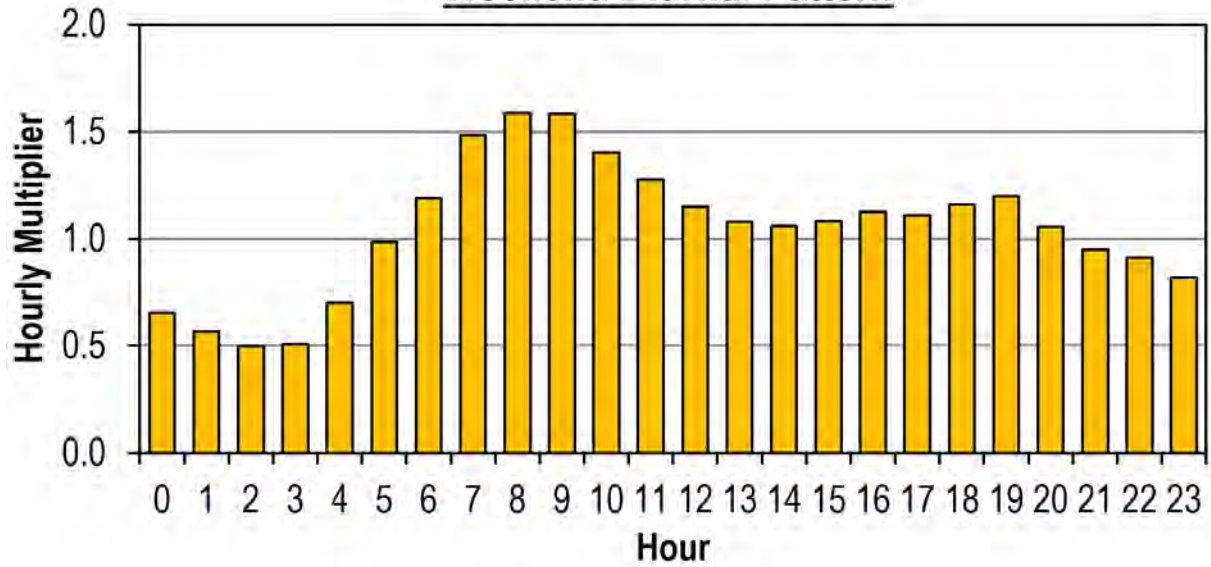

MH 2116

Weekday Diurnal Pattern

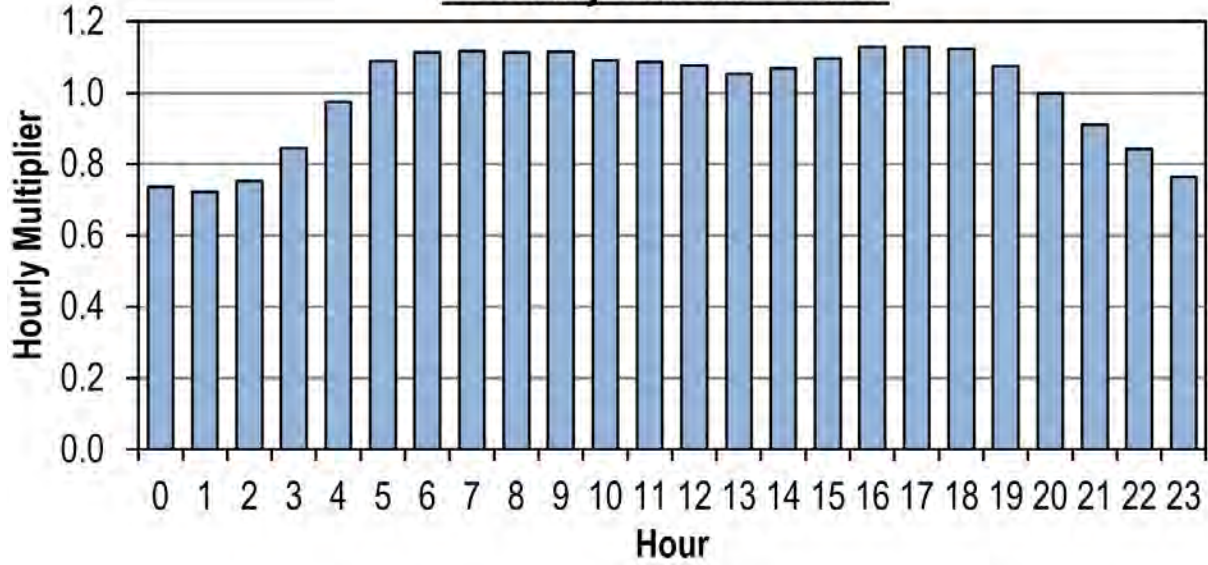

Weekend Diurnal Pattern

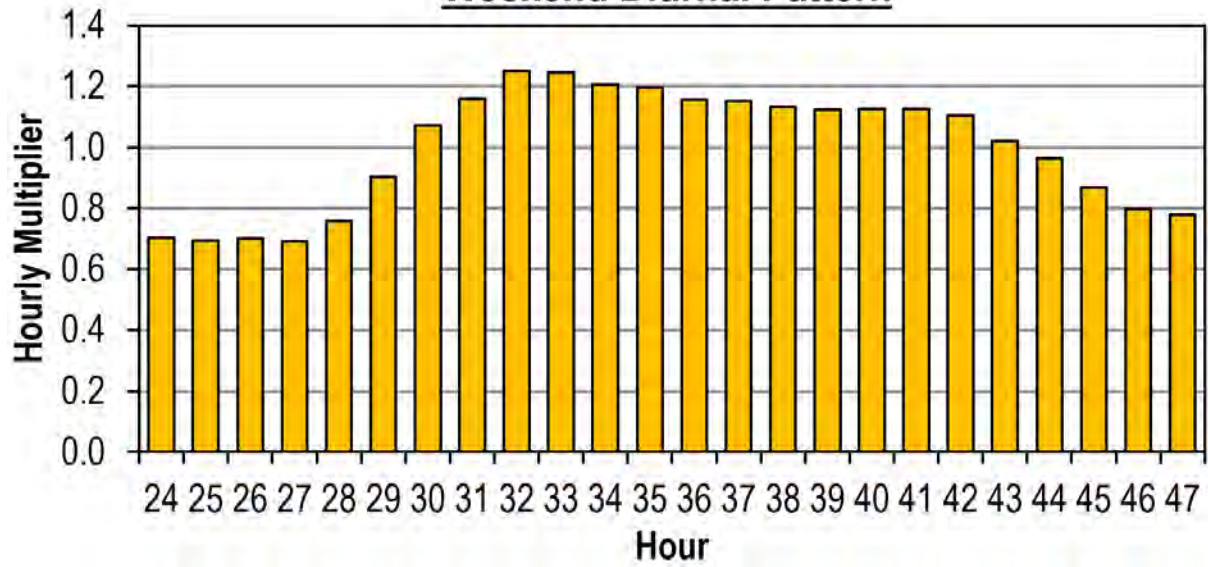

MH 2171

Weekday Diurnal Pattern

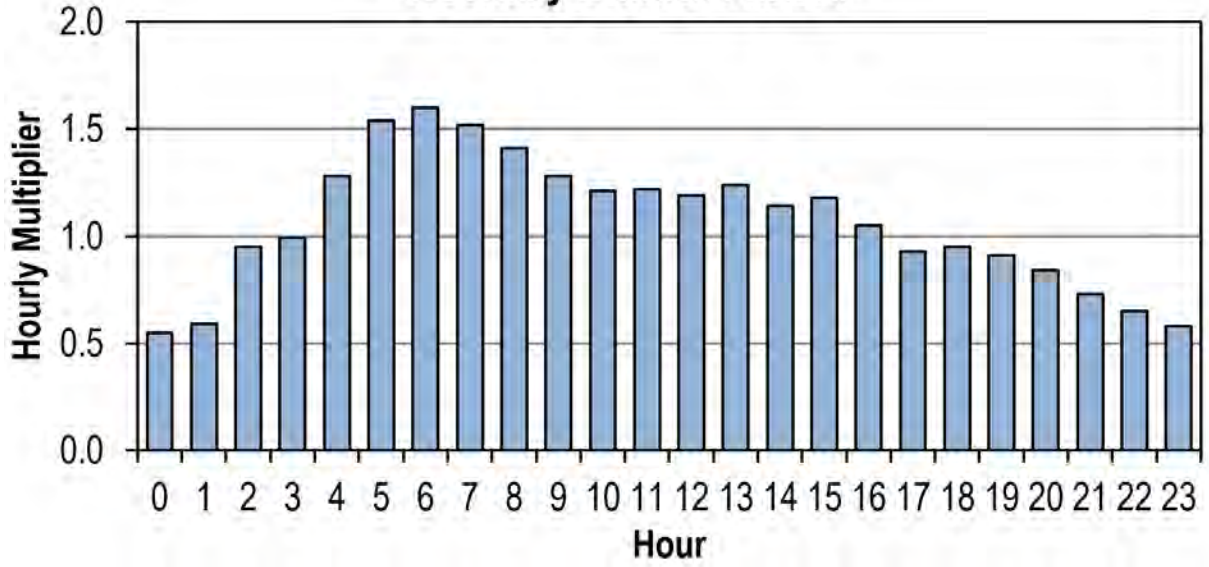

Weekday Diurnal Pattern

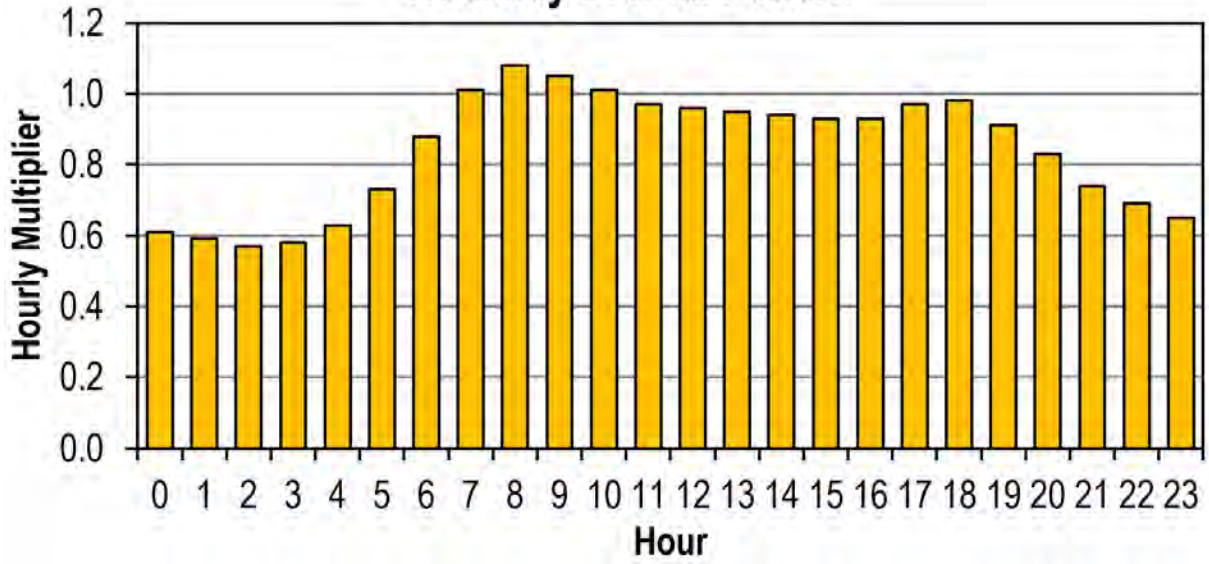

MH 2252

Weekday Diurnal Pattern

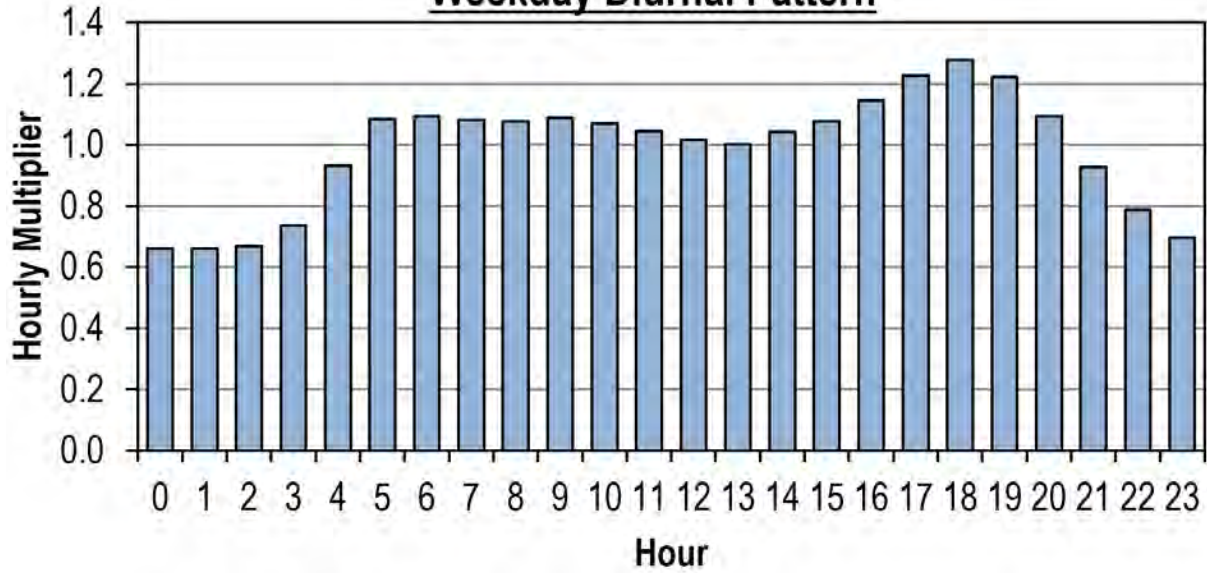

Weekend Diurnal Pattern

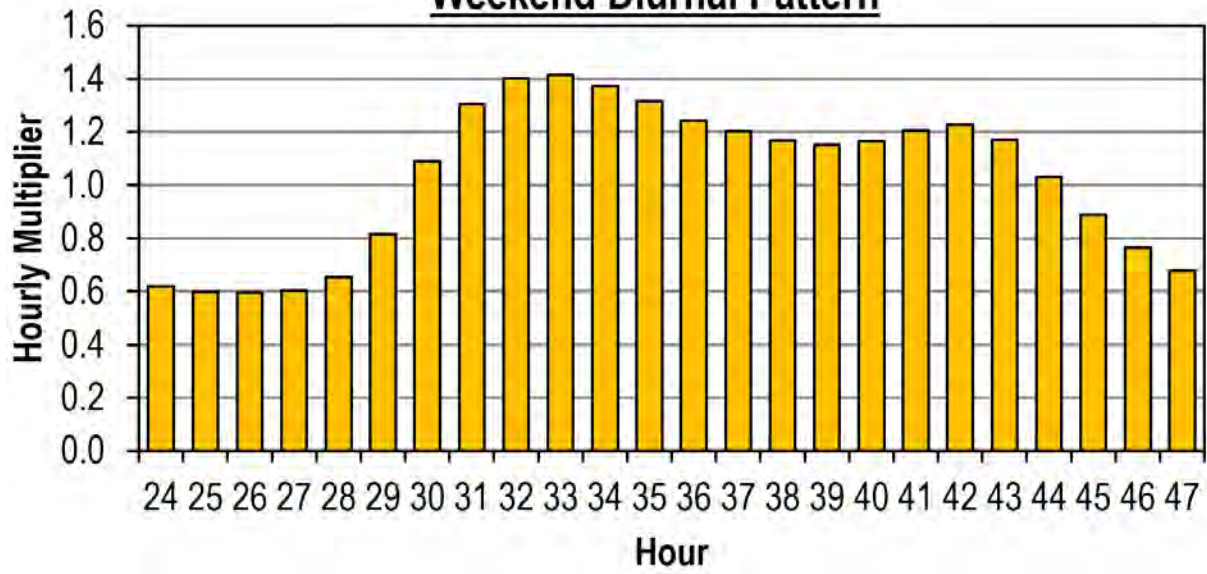

MH 2999

Weekday Diurnal Pattern

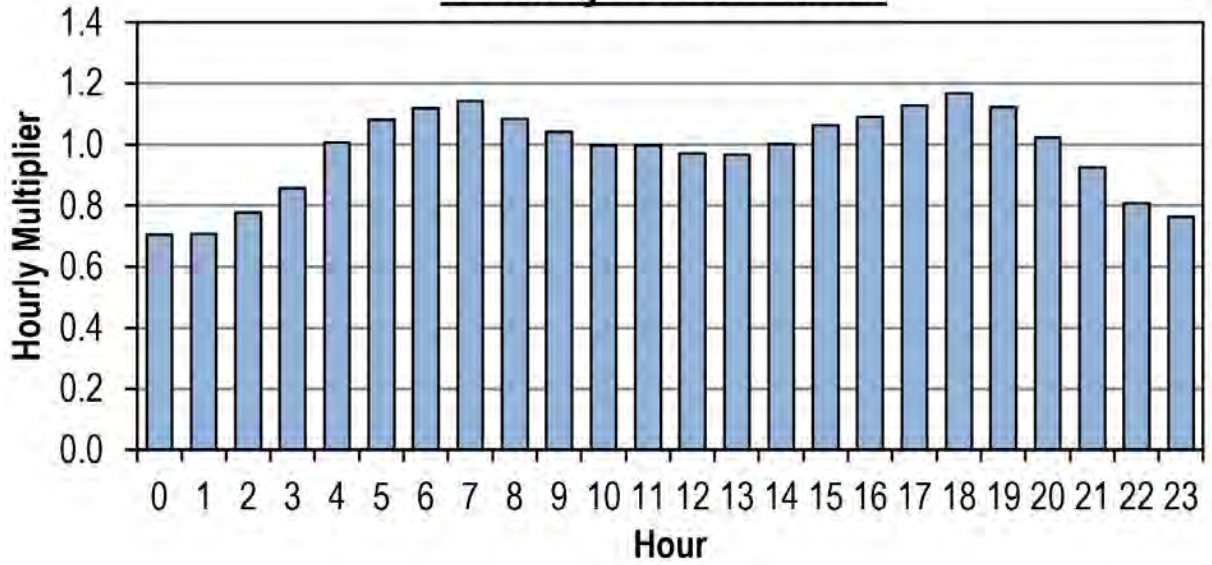

Weekend Diurnal Pattern

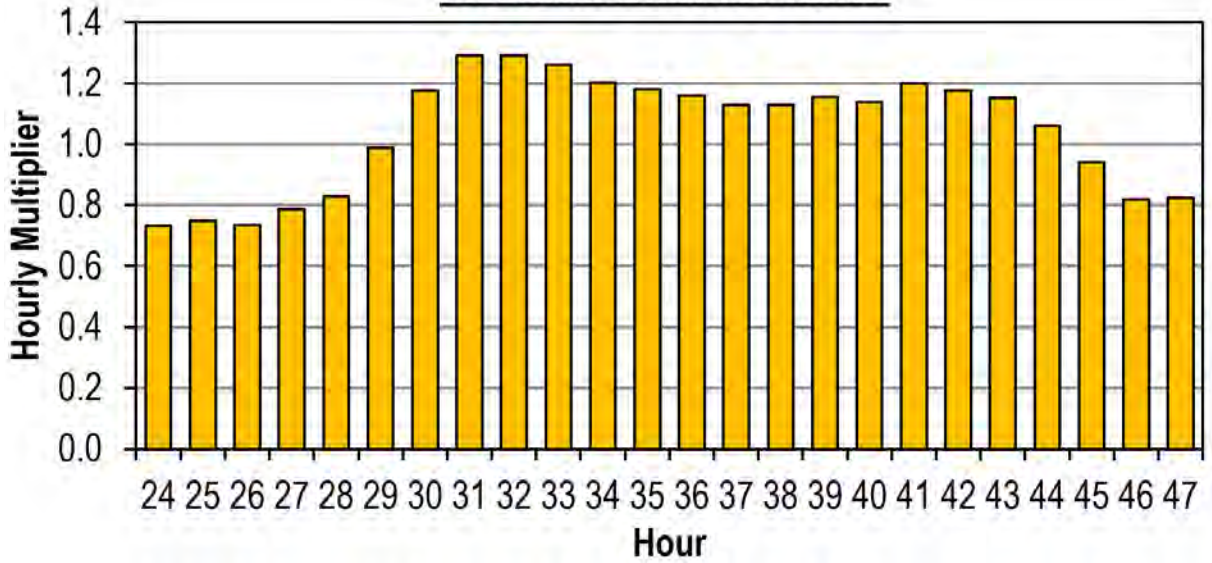

MH 3216

Weekday Diurnal Pattern

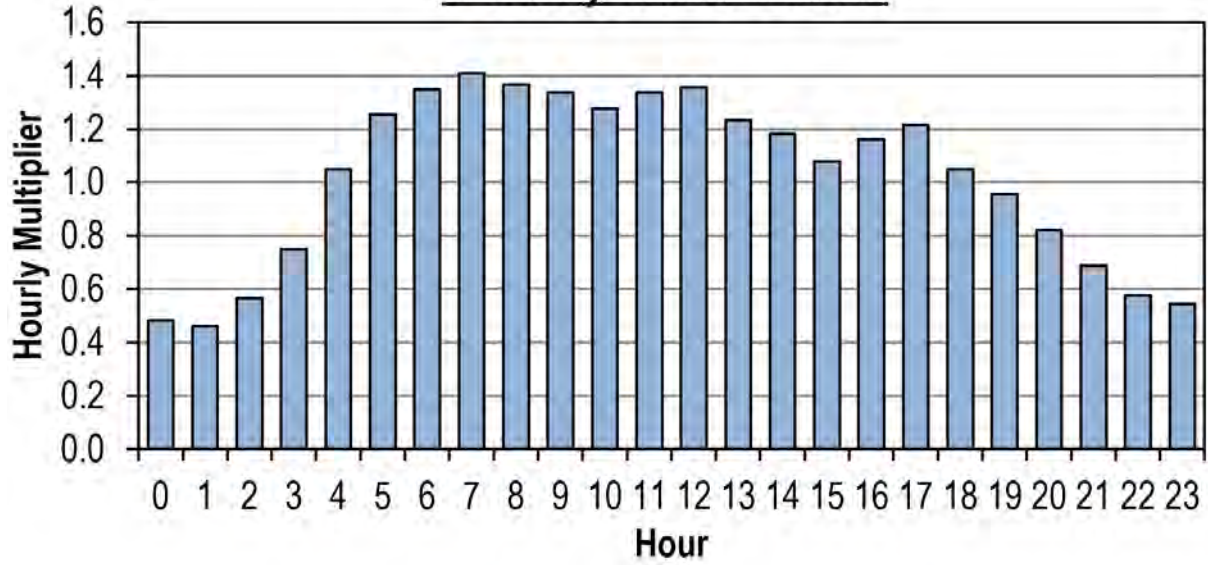

Weekend Diurnal Pattern

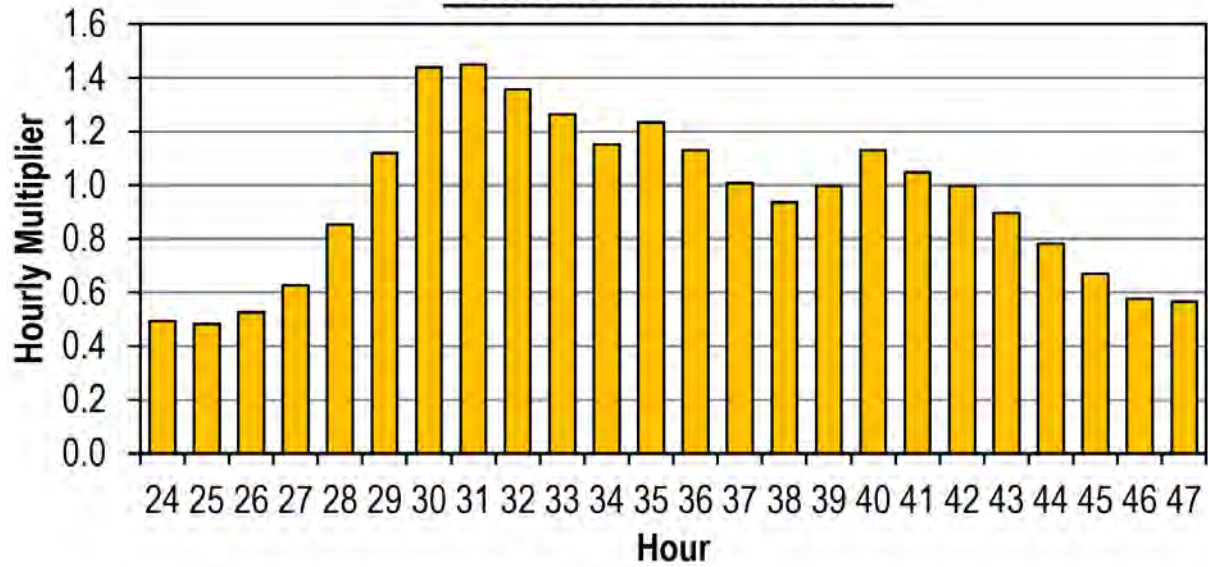

MH 3625

Weekday Diurnal Pattern

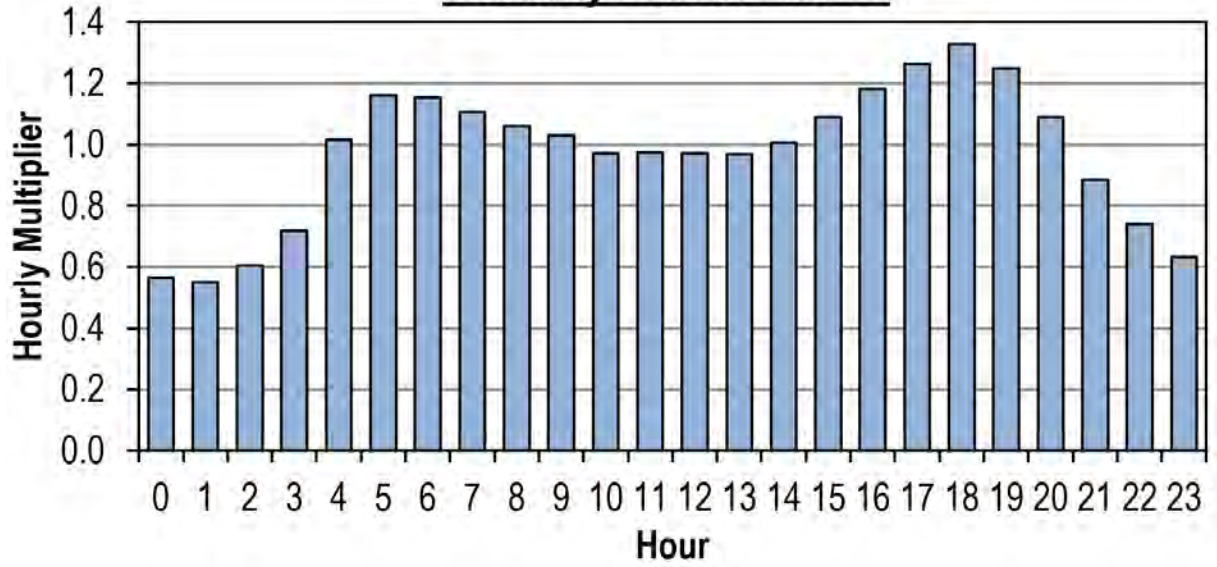

Weekend Diurnal Pattern

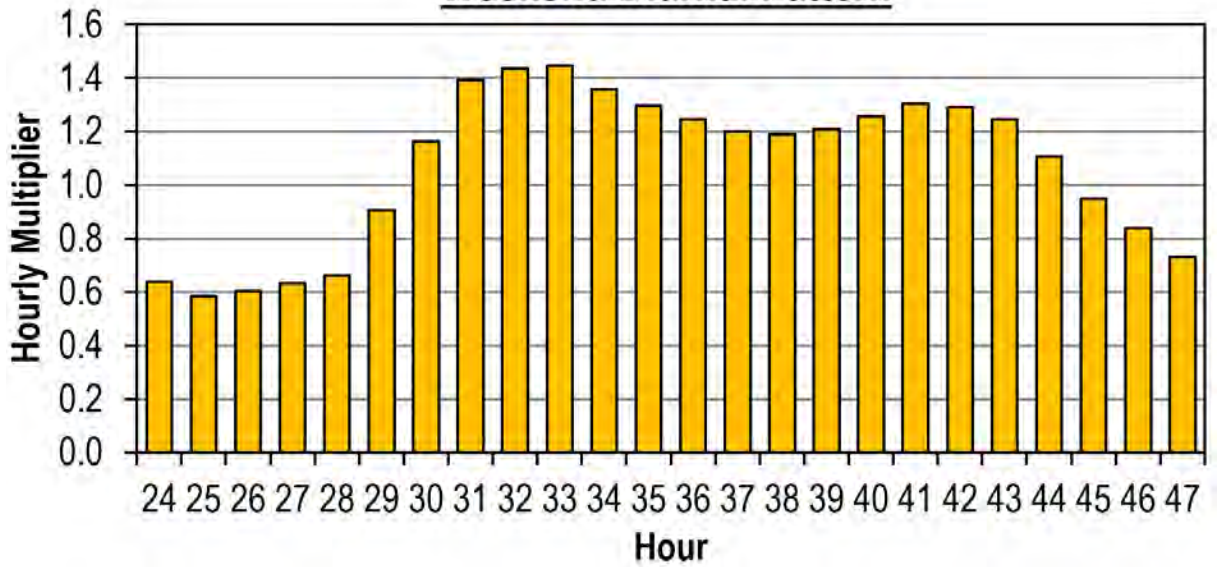

MH 4628

Weekday Diurnal Pattern

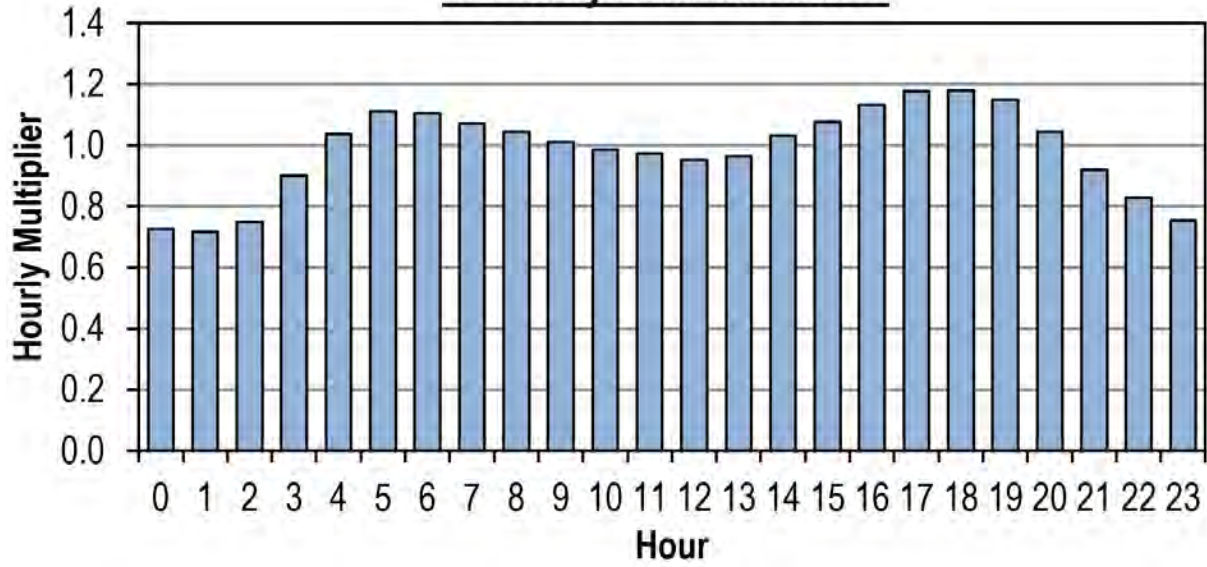

Weekend Diurnal Pattern

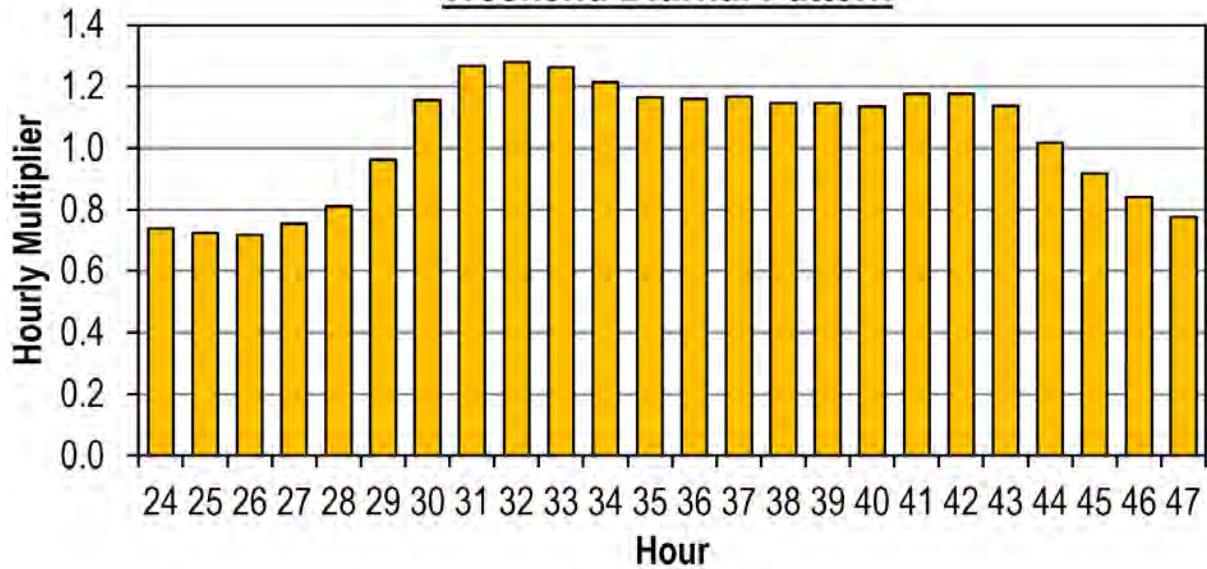

MH 4646

Weekday Diurnal Pattern

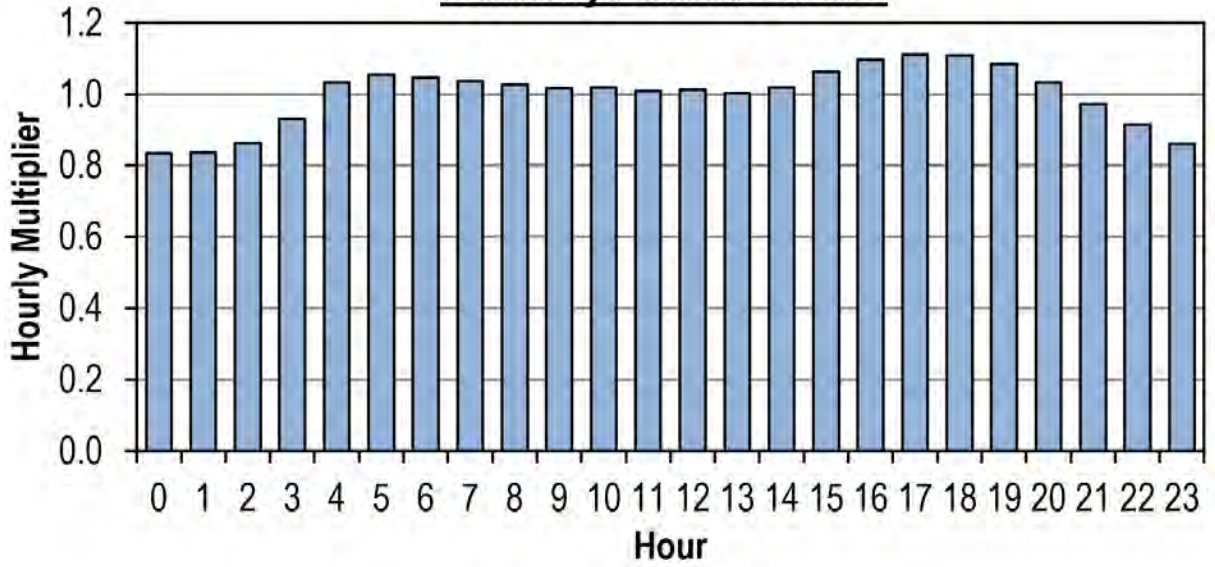

Weekend Diurnal Pattern

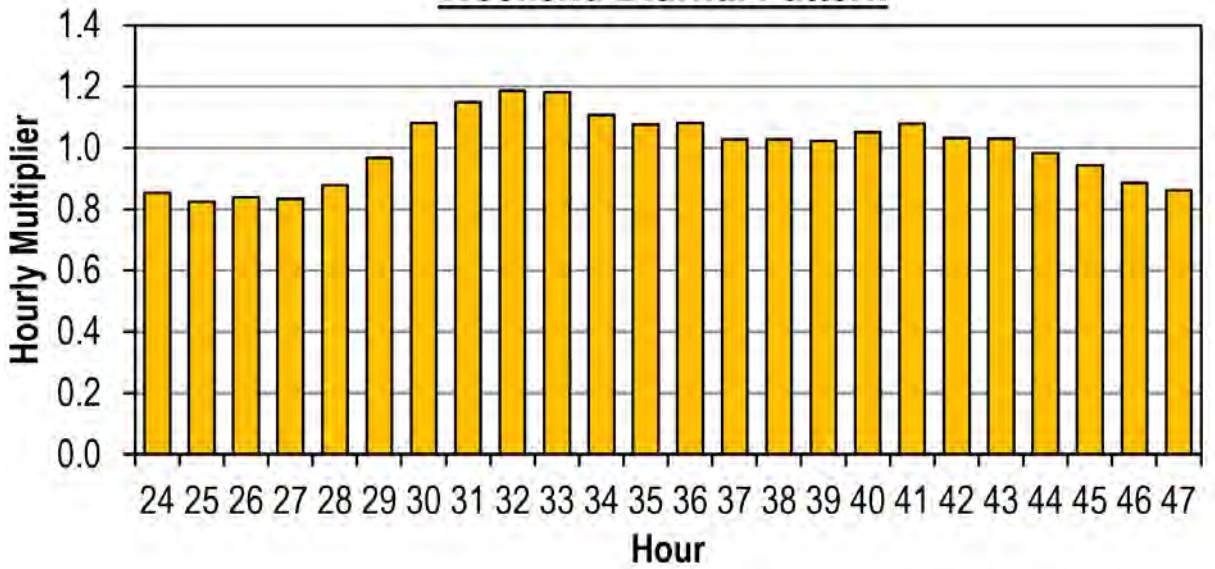

MH 5302

Weekday Diurnal Pattern

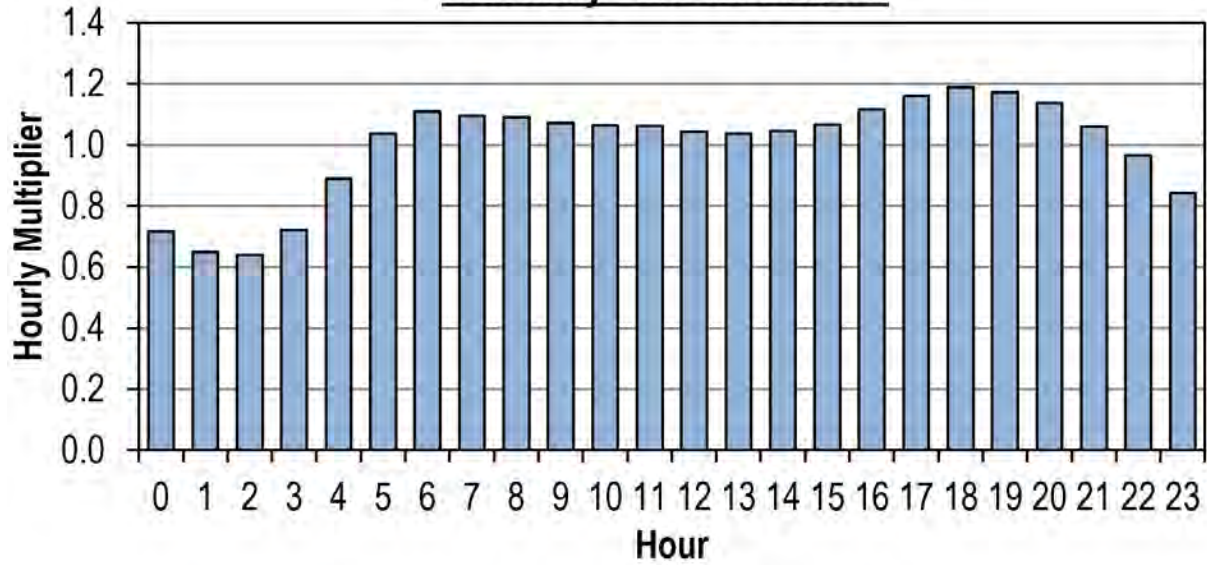

Weekend Diurnal Pattern

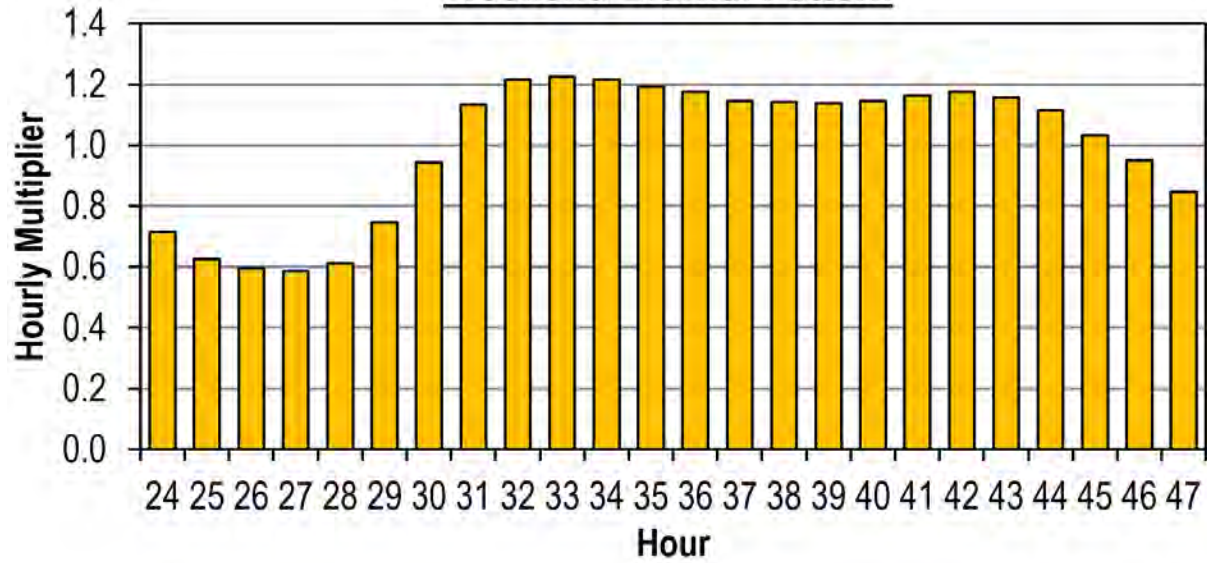

MH 5505

Weekday Diurnal Pattern

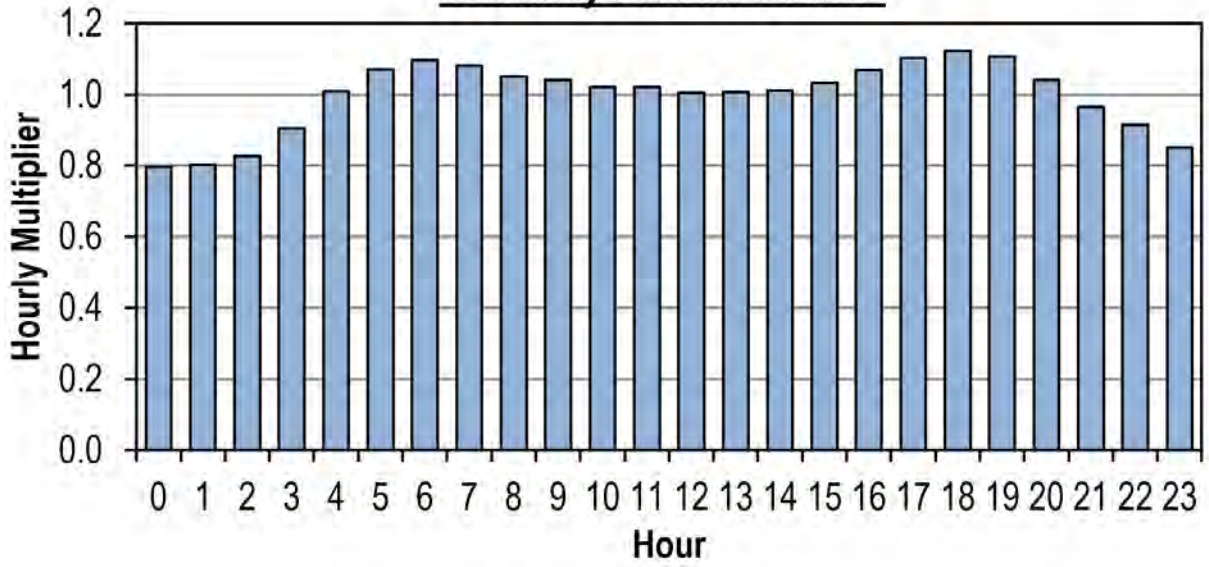

Weekend Diurnal Pattern

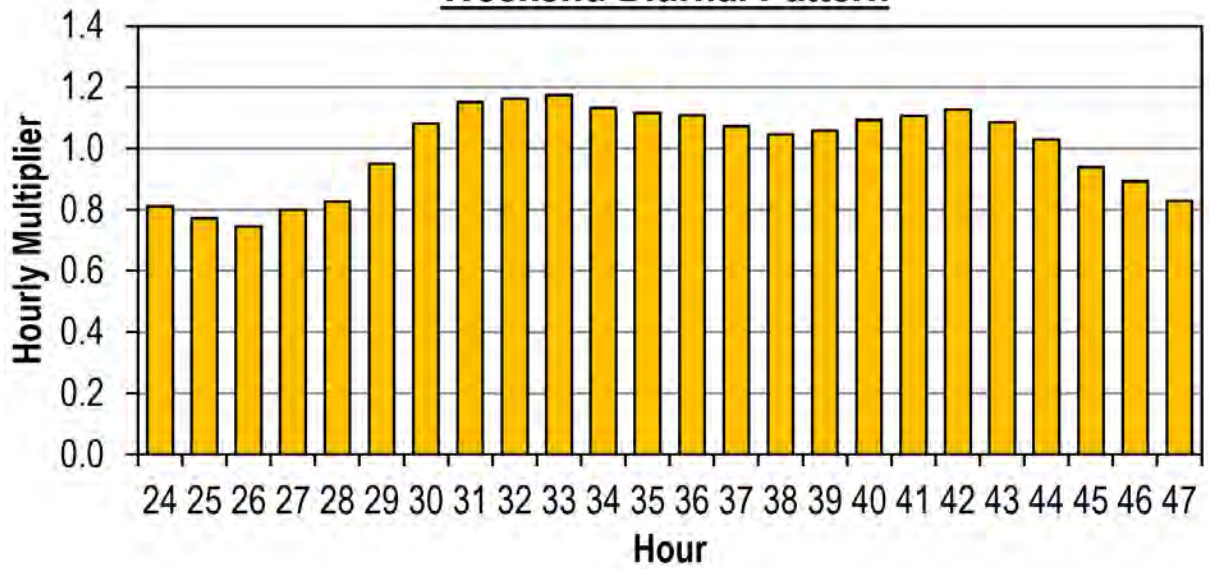

MH 5519

Weekday Diurnal Pattern

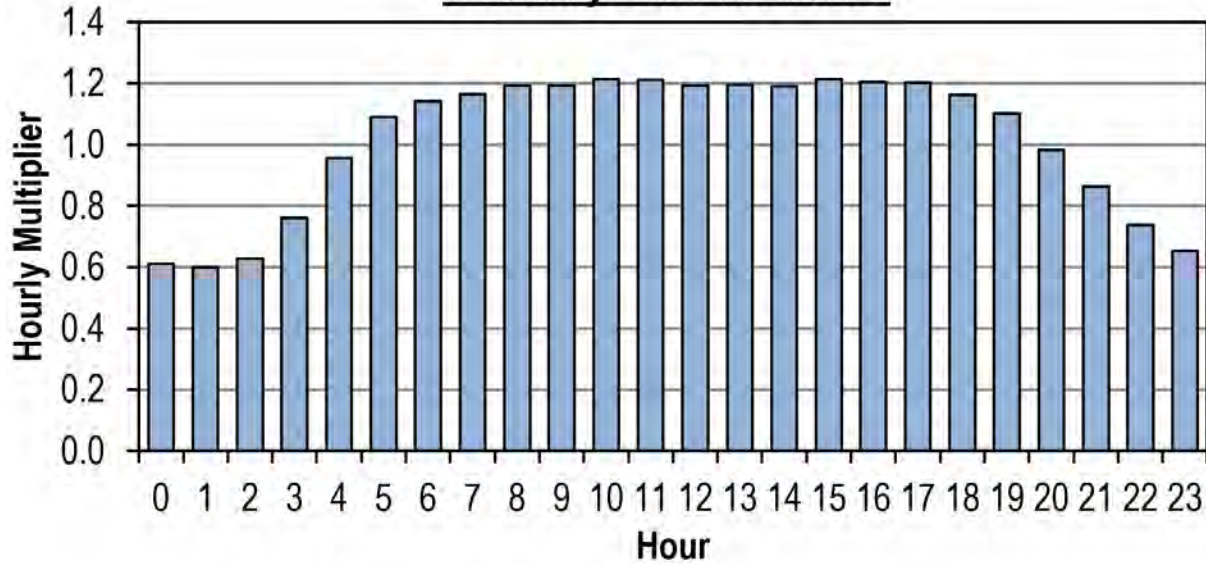

Weekend Diurnal Pattern

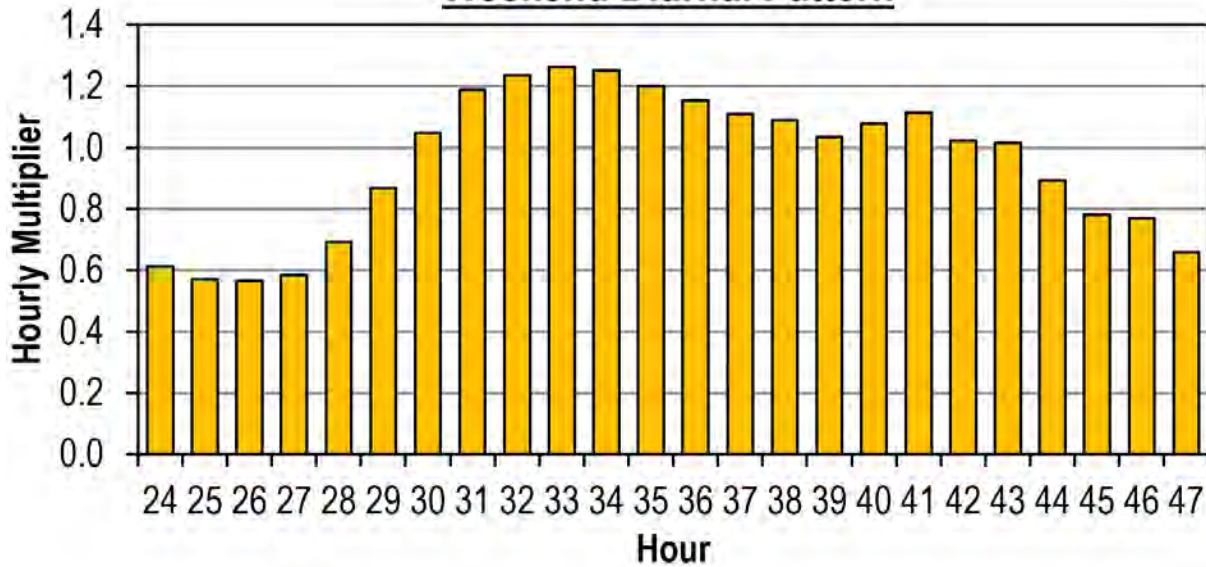

MH 6041

Weekday Diurnal Pattern

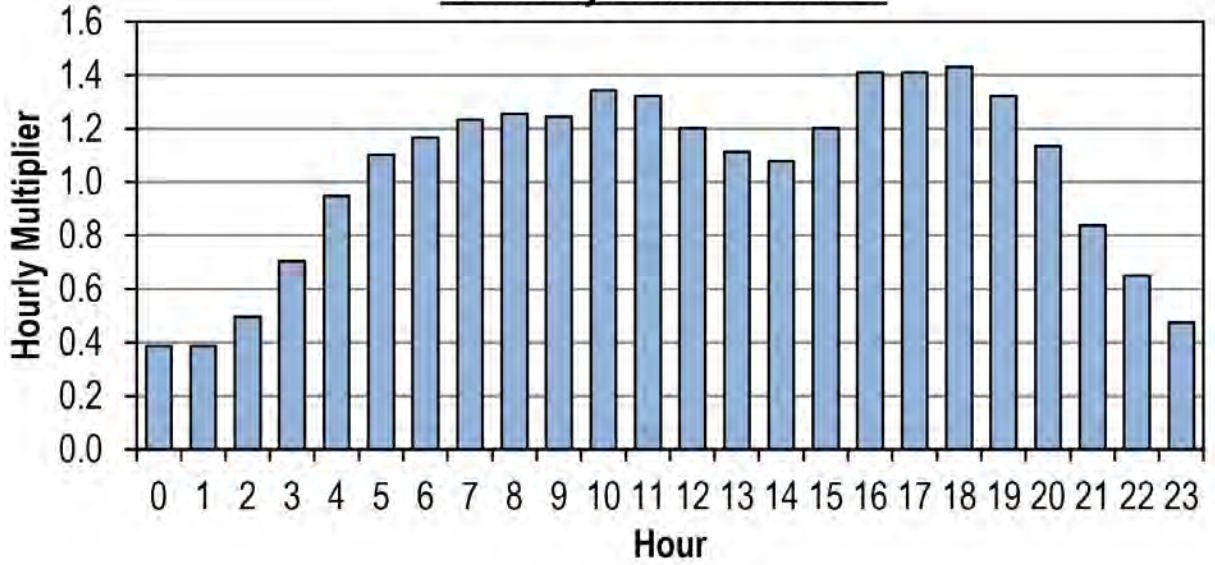

Weekend Diurnal Pattern

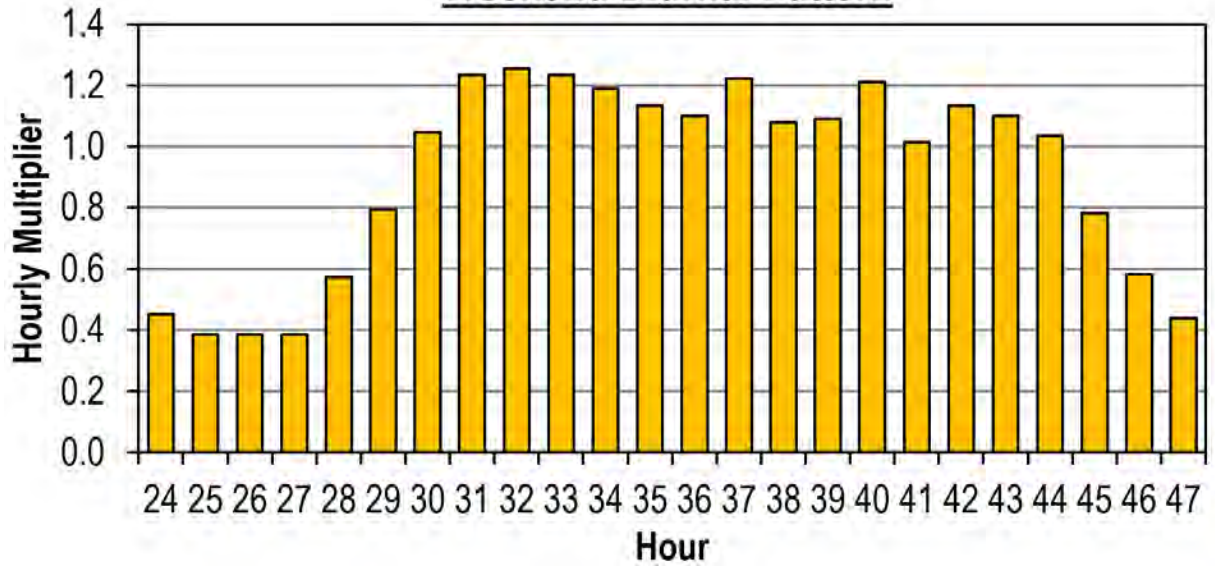

MH 6704

Weekday Diurnal Pattern

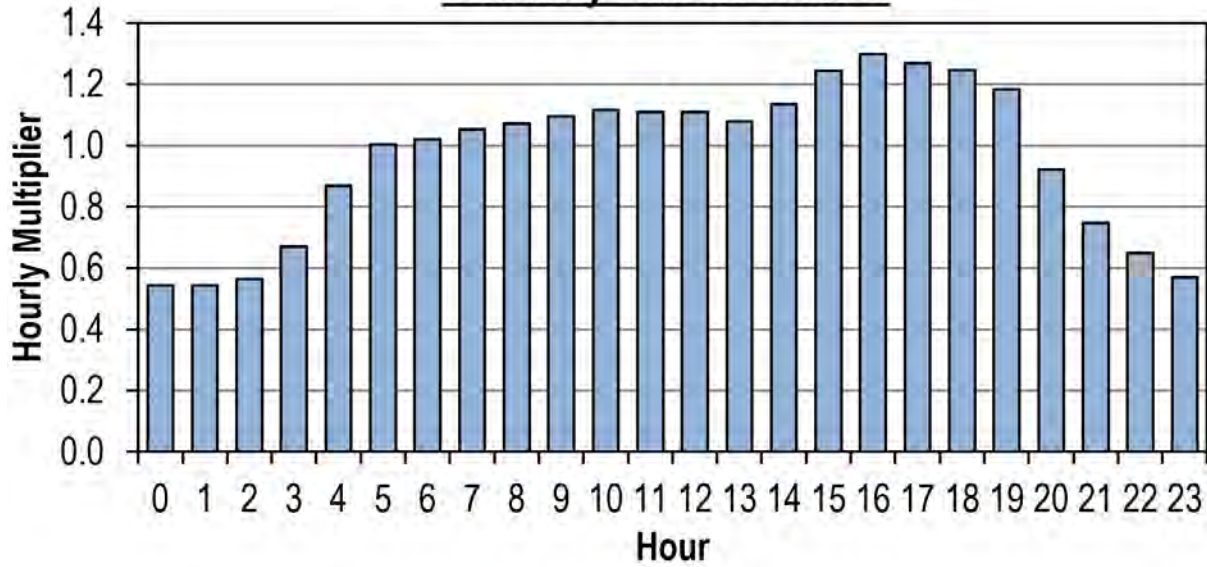

Weekend Diurnal Pattern

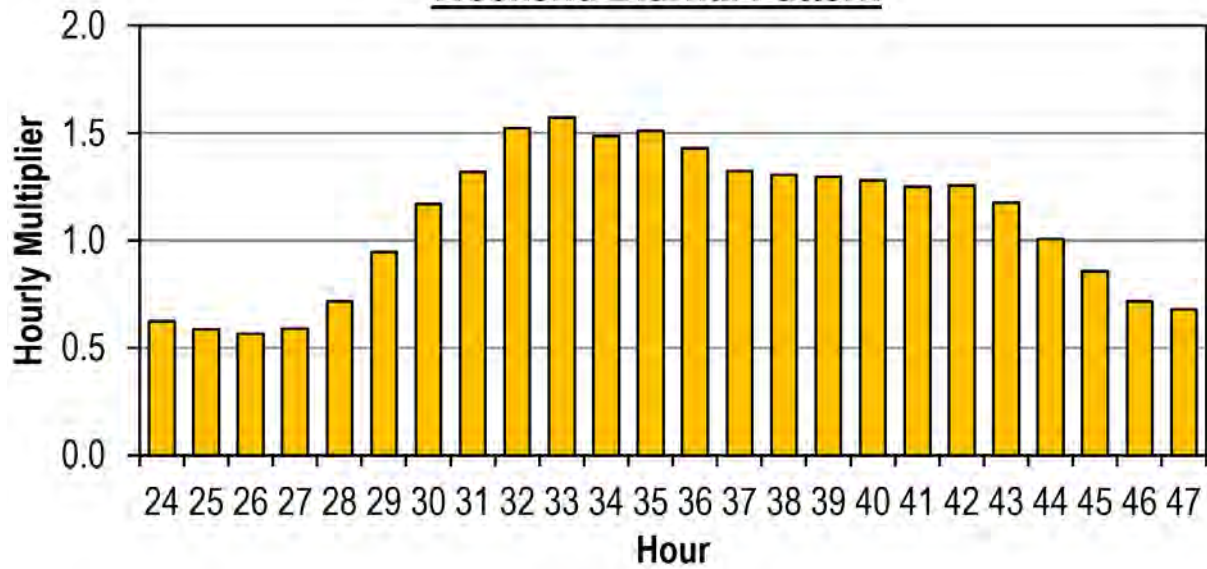

Attachment F

DRY WEATHER CALIBRATION RESULTS

Table 1 Dry Weather Flow Calibration Results
Long-range Wastewater Management Plan
City of Renton

Meter Number		Pipe Diameter (in)		Weekday Dry Weather Flow										
				Measured Data ⁽¹⁾				Modeled Data ⁽²⁾				Percent Error ⁽³⁾		
				Avg. Flow (mgd)	Peak Flow (mgd)	Avg. Velocity (ft/s)	Avg. Level (in)	Avg. Flow (mgd)	Peak Flow (mgd)	Avg. Velocity (ft/s)	Avg. Level (in)	Avg. Flow (%)	Peak Flow (%)	Max Level Diff (in)
MH0166	12	0.015	0.026	0.30	1.2	0.014	0.024	0.73	1.1	-1.3%	-6.4%	0.24		
MH0286	9.88	0.073	0.095	0.66	3.5	0.073	0.095	0.98	2.9	0.7%	0.6%	0.76		
MH0537	8	0.317	0.392	8.73	1.7	0.315	0.379	7.32	2.1	-0.7%	-3.1%	0.47		
MH1360	10.75	0.203	0.255	3.40	2.2	0.216	0.260	1.91	3.6	6.1%	2.3%	1.55		
MH1763	15	0.167	0.231	0.40	7.8	0.168	0.234	0.74	6.1	0.9%	1.7%	3.59		
MH2116	14.38	0.574	0.648	2.86	4.5	0.525	0.648	2.59	5.7	-8.5%	0.1%	1.54		
MH2171	11.25	0.184	0.278	1.25	4.0	0.184	0.273	1.29	4.7	-0.4%	-1.7%	1.30		
MH2252	18	0.648	0.837	4.62	3.2	0.649	0.829	2.79	3.3	0.2%	-1.0%	0.21		
MH2999	8	0.175	0.208	5.22	1.6	0.160	0.221	3.99	2.0	-8.4%	6.5%	0.75		
MH3216	7.38	0.050	0.069	0.89	2.4	0.048	0.066	1.02	2.5	-2.4%	-3.3%	0.38		
MH3625	12	0.533	0.729	2.57	5.0	0.535	0.673	2.74	4.7	0.4%	-7.7%	0.87		
MH4628	10.38	0.163	0.195	4.27	1.8	0.165	0.197	3.73	1.6	1.4%	1.1%	0.28		
MH4646	8	0.205	0.229	9.02	1.3	0.205	0.228	7.95	4.5	0.0%	-0.1%	3.72		
MH5302	19.88	1.689	2.009	3.22	8.1	1.542	1.974	3.76	6.4	-8.7%	-1.7%	2.16		
MH5505	10	0.211	0.238	5.85	1.6	0.212	0.241	4.03	2.1	0.6%	1.3%	0.56		
MH5519	10.25	0.319	0.380	5.84	2.1	0.325	0.386	5.14	2.8	1.7%	1.5%	0.91		
MH6041	8	0.047	0.065	3.75	0.8	0.045	0.062	1.53	2.1	-3.5%	-4.5%	1.52		
MH6704	12	0.114	0.154	5.58	1.0	0.118	0.158	5.57	2.0	3.6%	2.7%	1.24		

Notes:

1. Source: City of Renton 2018 Temporary Flow Monitoring Program, ADS
2. Average flow, level, and velocity are computed from hydraulic modeling results. Maximum flow values are hourly peaks.
3. Percent Difference = (Modeled - Measured)/Measured*100.



City of Renton
Long-range Wastewater Management Plan
FLOW MONITORING SITE MH0166 DRY WEATHER FLOW CALIBRATION



Hour	Measured Data			Modeled Data			Level Diff (in)	Diurnal		
	Flow (mgd)	Level (in)	Velocity (ft/s)	Flow (mgd)	Level (in)	Velocity (ft/s)		Initial Curve	Modified Curve	Calibrated Diurnal
Weekday										
0	0.009	0.9	0.12	0.010	0.9	0.66	0.06	0.75	0.61	0.61
1	0.009	0.9	0.10	0.009	0.8	0.64	0.06	0.75	0.61	0.61
2	0.009	0.9	0.09	0.009	0.8	0.64	0.04	0.75	0.61	0.61
3	0.009	0.9	0.08	0.009	0.8	0.64	0.03	0.75	0.61	0.61
4	0.009	0.9	0.07	0.009	0.8	0.64	0.02	0.75	0.61	0.61
5	0.009	0.8	0.07	0.009	0.8	0.64	0.00	0.84	0.68	0.68
6	0.010	0.9	0.07	0.009	0.9	0.65	-0.01	0.75	0.61	0.61
7	0.009	0.9	0.08	0.009	0.9	0.65	0.00	1.00	0.82	0.82
8	0.012	1.1	0.22	0.011	0.9	0.68	0.12	1.67	1.36	1.36
9	0.020	1.2	0.31	0.016	1.1	0.77	0.02	1.51	1.23	1.23
10	0.018	1.2	0.39	0.018	1.2	0.79	0.03	1.51	1.23	1.23
11	0.018	1.3	0.43	0.018	1.2	0.78	0.13	1.42	1.16	1.16
12	0.017	1.4	0.41	0.017	1.2	0.78	0.22	1.51	1.23	1.23
13	0.018	1.4	0.41	0.018	1.2	0.78	0.23	1.93	1.57	1.57
14	0.023	1.4	0.49	0.021	1.3	0.83	0.12	2.18	1.77	1.77
15	0.026	1.5	0.48	0.024	1.4	0.86	0.06	1.93	1.57	1.57
16	0.023	1.5	0.56	0.024	1.4	0.85	0.16	1.93	1.57	1.57
17	0.023	1.5	0.56	0.022	1.3	0.84	0.15	1.51	1.23	1.23
18	0.018	1.4	0.51	0.020	1.2	0.80	0.20	1.34	1.09	1.09
19	0.016	1.3	0.42	0.017	1.1	0.76	0.19	1.09	0.89	0.89
20	0.013	1.3	0.38	0.014	1.1	0.73	0.22	1.09	0.89	0.89
21	0.013	1.2	0.36	0.013	1.0	0.71	0.24	0.84	0.68	0.68
22	0.010	1.1	0.26	0.011	0.9	0.69	0.19	0.92	0.75	0.75
23	0.011	1.1	0.23	0.010	0.9	0.67	0.20	0.75	0.61	0.61
Weekend										
24	0.004	0.9	0.07	0.010	0.9	0.66	0.01	0.25	0.58	0.58
25	0.003	0.9	0.06	0.007	0.7	0.58	0.17	0.25	0.58	0.58
26	0.003	0.9	0.06	0.004	0.6	0.49	0.34	0.29	0.68	0.68
27	0.004	0.9	0.05	0.003	0.5	0.48	0.35	0.21	0.49	0.49
28	0.003	0.9	0.04	0.003	0.5	0.48	0.34	0.29	0.68	0.68
29	0.004	0.8	0.03	0.003	0.5	0.48	0.34	0.25	0.58	0.58
30	0.003	0.8	0.03	0.003	0.5	0.48	0.34	0.17	0.39	0.39
31	0.002	0.8	0.03	0.003	0.5	0.47	0.36	0.21	0.49	0.49
32	0.003	0.9	0.07	0.003	0.5	0.45	0.42	0.29	0.68	0.68
33	0.004	0.9	0.11	0.003	0.5	0.47	0.45	0.42	0.97	0.97
34	0.005	1.0	0.12	0.004	0.6	0.51	0.42	0.50	1.17	1.17
35	0.006	1.0	0.15	0.005	0.7	0.56	0.39	0.54	1.27	1.27
36	0.007	1.1	0.22	0.006	0.7	0.58	0.38	0.50	1.17	1.17
37	0.006	1.1	0.19	0.006	0.7	0.58	0.36	0.54	1.27	1.27
38	0.007	1.1	0.20	0.006	0.7	0.58	0.39	0.71	1.66	1.66
39	0.009	1.1	0.17	0.007	0.8	0.61	0.29	0.84	1.95	1.95
40	0.010	1.0	0.15	0.009	0.8	0.65	0.19	0.63	1.46	1.46
41	0.008	1.0	0.13	0.009	0.8	0.64	0.17	0.67	1.56	1.56
42	0.008	1.0	0.13	0.008	0.8	0.62	0.21	0.54	1.27	1.27
43	0.007	1.0	0.14	0.007	0.8	0.60	0.24	0.42	0.97	0.97
44	0.005	0.9	0.11	0.006	0.7	0.57	0.25	0.54	1.27	1.27
45	0.007	0.9	0.11	0.006	0.7	0.57	0.26	0.54	1.27	1.27
46	0.007	0.9	0.11	0.006	0.7	0.58	0.24	0.38	0.88	0.88
47	0.005	0.9	0.07	0.006	0.7	0.56	0.24	0.29	0.68	0.68
Average										
Weekday	0.015	1.2	0.30	0.014	1.1	0.73		1.23	1.00	1.00
Weekend	0.005	1.0	0.11	0.006	0.7	0.55		0.43	1.00	1.00
ADWF ⁽¹⁾	0.012	1.1	0.24	0.012	0.9	0.68		1.00	1.00	1.00
% Error										
Weekday					-1.3%		0.24			
Weekend					7.8%		0.45			
Note:										

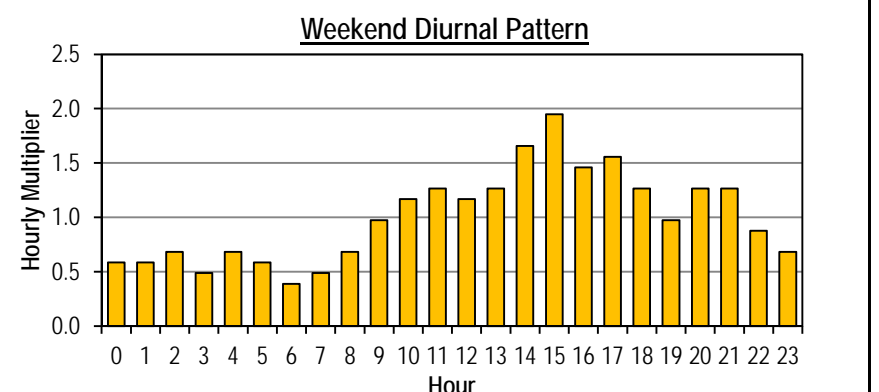
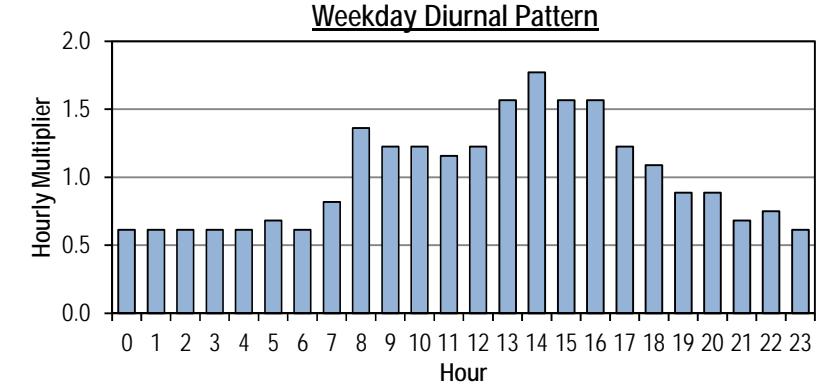
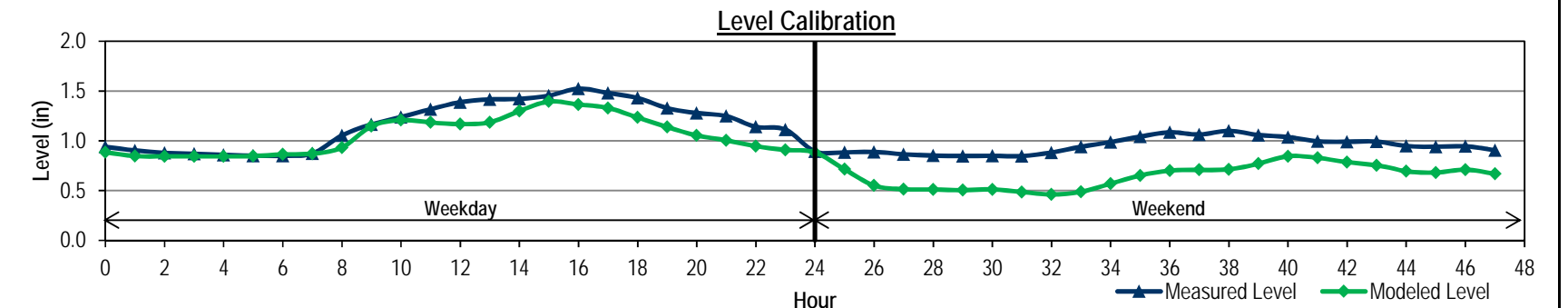
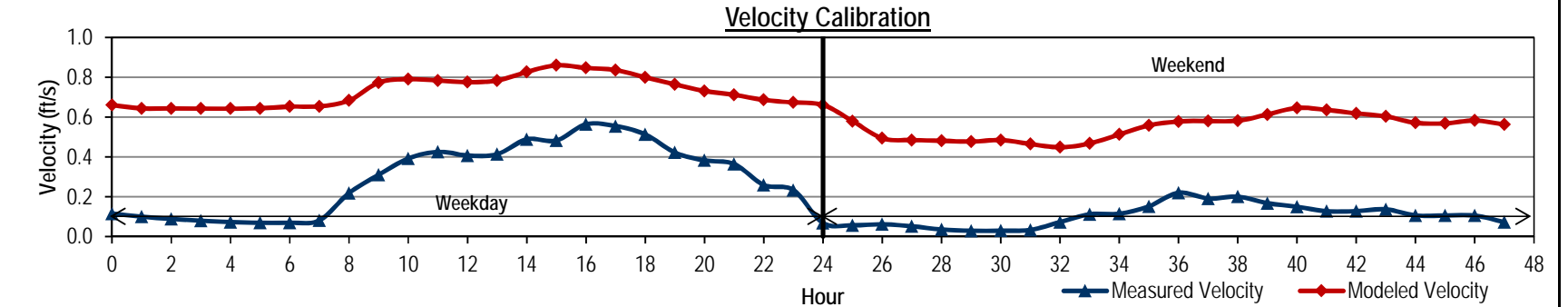
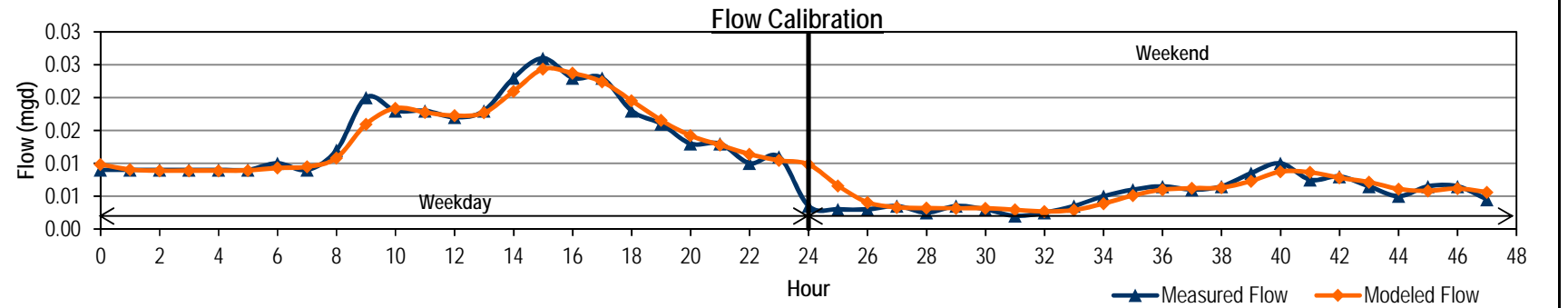



City of Renton
Long-range Wastewater Management Plan
FLOW MONITORING SITE MH0286 DRY WEATHER FLOW CALIBRATION



Hour	Measured Data			Modeled Data			Level Diff (in)	Diurnal		
	Flow (mgd)	Level (in)	Velocity (ft/s)	Flow (mgd)	Level (in)	Velocity (ft/s)		Initial Curve	Modified Curve	Calibrated Diurnal
Weekday										
0	0.058	3.2	0.58	0.051	2.465	0.75	0.76	0.84	0.76	0.77
1	0.056	3.2	0.58	0.056	2.553	0.91	0.66	0.86	0.77	0.78
2	0.057	3.2	0.57	0.058	2.579	0.92	0.61	0.89	0.80	0.81
3	0.059	3.2	0.58	0.060	2.604	0.92	0.61	0.88	0.79	0.80
4	0.058	3.2	0.59	0.061	2.630	0.84	0.60	0.97	0.88	0.89
5	0.064	3.3	0.60	0.064	2.766	0.89	0.50	1.08	0.97	0.98
6	0.071	3.4	0.64	0.070	2.902	0.99	0.48	1.19	1.07	1.08
7	0.078	3.5	0.67	0.080	3.009	1.03	0.49	1.26	1.14	1.15
8	0.083	3.6	0.71	0.085	3.098	1.07	0.52	1.35	1.21	1.22
9	0.089	3.7	0.72	0.090	3.184	1.10	0.50	1.42	1.28	1.29
10	0.094	3.8	0.75	0.094	3.251	1.12	0.51	1.43	1.29	1.30
11	0.094	3.8	0.75	0.095	3.265	1.13	0.52	1.44	1.29	1.31
12	0.095	3.8	0.76	0.095	3.266	1.13	0.54	1.41	1.27	1.29
13	0.093	3.8	0.76	0.093	3.226	1.11	0.58	1.34	1.21	1.22
14	0.088	3.8	0.75	0.088	3.140	1.08	0.61	1.27	1.14	1.16
15	0.084	3.7	0.72	0.084	3.064	1.06	0.60	1.22	1.10	1.11
16	0.081	3.6	0.71	0.080	2.977	1.03	0.65	1.11	1.00	1.01
17	0.073	3.5	0.68	0.074	2.851	0.99	0.69	1.05	0.95	0.95
18	0.069	3.4	0.65	0.070	2.771	0.96	0.68	1.01	0.91	0.92
19	0.067	3.4	0.64	0.067	2.708	0.92	0.70	0.95	0.86	0.86
20	0.063	3.4	0.62	0.063	2.639	0.94	0.71	0.92	0.83	0.84
21	0.061	3.3	0.60	0.062	2.613	0.88	0.66	0.90	0.82	0.82
22	0.060	3.3	0.60	0.060	2.587	0.90	0.67	0.87	0.78	0.79
23	0.057	3.2	0.58	0.058	2.528	0.84	0.68	0.87	0.70	0.70
Weekend										
24	0.048	3.1	0.53	0.050	2.425	0.75	0.64	0.71	0.97	0.90
25	0.047	3.0	0.51	0.046	2.273	0.75	0.77	0.71	0.96	0.96
26	0.047	3.0	0.51	0.048	2.315	0.80	0.71	0.69	0.93	0.94
27	0.046	3.0	0.51	0.047	2.306	0.71	0.70	0.69	0.93	0.94
28	0.046	3.0	0.51	0.046	2.310	0.75	0.69	0.70	0.95	0.95
29	0.046	3.0	0.51	0.048	2.324	0.76	0.67	0.71	0.97	0.98
30	0.047	3.0	0.51	0.049	2.338	0.81	0.69	0.72	0.98	0.99
31	0.048	3.0	0.52	0.049	2.334	0.88	0.71	0.72	0.98	0.99
32	0.048	3.1	0.52	0.050	2.323	0.86	0.73	0.73	0.99	1.00
33	0.048	3.1	0.52	0.048	2.320	0.83	0.74	0.74	1.00	1.01
34	0.049	3.1	0.53	0.050	2.327	0.74	0.74	0.75	1.01	1.02
35	0.049	3.1	0.52	0.051	2.331	0.74	0.74	0.75	1.02	1.03
36	0.050	3.1	0.53	0.051	2.348	0.82	0.75	0.78	1.05	1.06
37	0.051	3.1	0.53	0.052	2.376	0.82	0.75	0.78	1.05	1.06
38	0.051	3.1	0.53	0.050	2.374	0.82	0.75	0.75	1.02	1.03
39	0.050	3.1	0.53	0.052	2.370	0.82	0.74	0.79	1.07	1.08
40	0.052	3.1	0.54	0.051	2.407	0.80	0.71	0.78	1.05	1.06
41	0.051	3.1	0.55	0.050	2.396	0.82	0.72	0.78	1.06	1.07
42	0.052	3.1	0.55	0.053	2.393	0.87	0.73	0.75	1.02	1.03
43	0.050	3.1	0.54	0.051	2.355	0.75	0.77	0.73	0.99	1.00
44	0.048	3.1	0.52	0.047	2.325	0.71	0.76	0.71	0.97	0.98
45	0.047	3.1	0.52	0.049	2.309	0.79	0.78	0.72	0.98	0.99
46	0.048	3.0	0.52	0.047	2.330	0.77	0.72	0.72	0.98	0.99
47	0.048	3.0	0.51	0.049	2.336	0.79	0.69	0.73	0.99	1.00
Average										
Weekday	0.073	3.5	0.66	0.073	2.9	0.98		1.11	0.99	1.00
Weekend	0.048	3.1	0.52	0.049	2.3	0.79		0.74	0.99	1.00
ADWF ⁽¹⁾	0.066	3.4	0.62	0.066	2.7	0.93		1.00	0.99	1.00
% Error										
Weekday				0.7%			0.76			
Weekend				2.1%			0.78			
Note:										

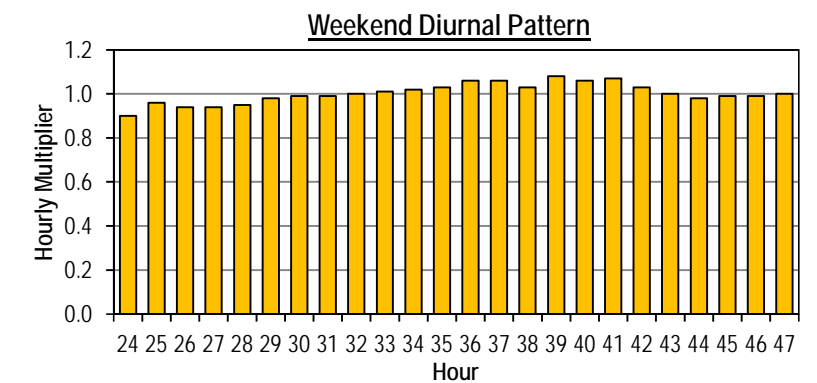
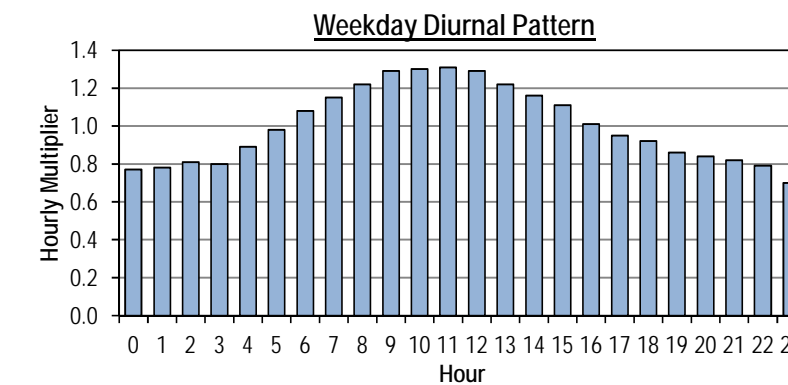
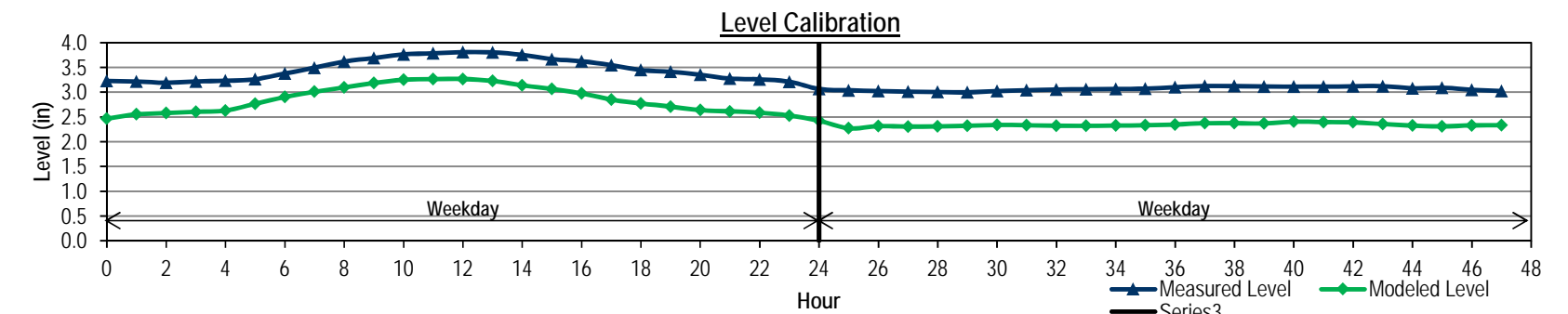
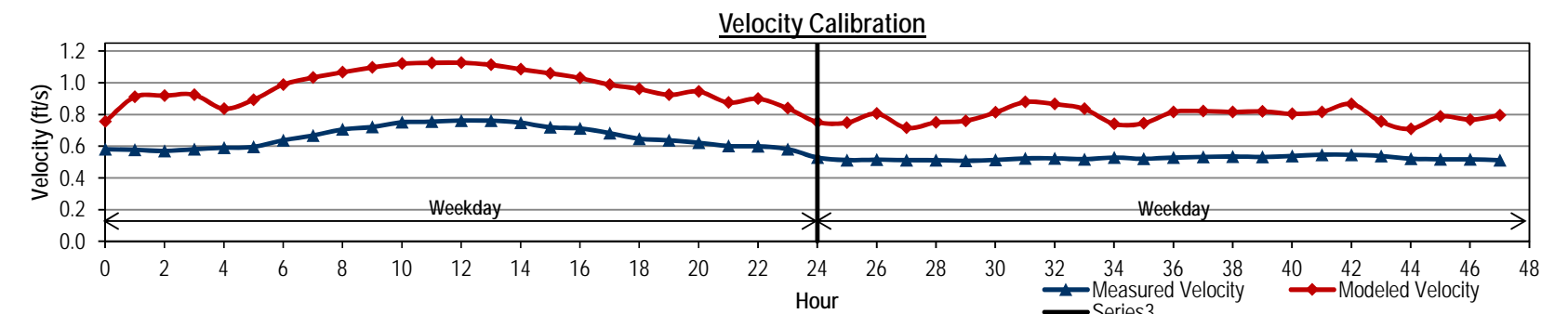
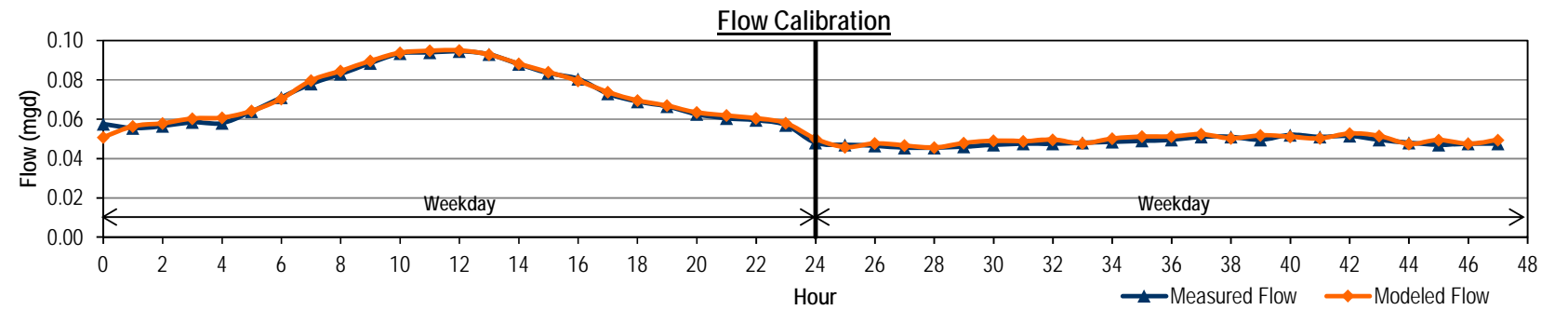



City of Renton
Long-range Wastewater Management Plan
FLOW MONITORING SITE MH0537 DRY WEATHER FLOW CALIBRATION



Hour	Measured Data			Modeled Data			Level Diff (in)	Diurnal		
	Flow (mgd)	Level (in)	Velocity (ft/s)	Flow (mgd)	Level (in)	Velocity (ft/s)		Initial Curve	Modified Curve	Calibrated Diurnal
0	0.247	1.6	8.22	0.266	1.9	6.95	-0.38	0.71		0.71
1	0.225	1.5	7.89	0.236	1.8	6.71	-0.34	0.68		0.68
2	0.217	1.4	7.65	0.219	1.8	6.56	-0.33	0.69		0.69
3	0.219	1.4	7.58	0.216	1.8	6.55	-0.33	0.75		0.75
4	0.240	1.5	7.90	0.231	1.8	6.69	-0.35	1.00		1.00
5	0.317	1.6	8.41	0.280	2.1	7.21	-0.47	1.20		1.20
6	0.380	1.8	9.04	0.347	2.3	7.62	-0.47	1.23		1.23
7	0.392	1.9	9.29	0.379	2.3	7.77	-0.43	1.14		1.14
8	0.363	1.9	9.20	0.370	2.3	7.65	-0.41	1.10		1.10
9	0.350	1.8	9.07	0.352	2.2	7.55	-0.42	1.02		1.02
10	0.325	1.8	8.98	0.332	2.2	7.43	-0.40	0.99		0.99
11	0.316	1.7	8.86	0.319	2.1	7.33	-0.40	0.99		0.99
12	0.313	1.7	8.78	0.314	2.1	7.29	-0.41	0.97		0.97
13	0.308	1.7	8.76	0.308	2.1	7.28	-0.41	0.99		0.99
14	0.313	1.7	8.76	0.310	2.1	7.32	-0.43	0.99		0.99
15	0.314	1.7	8.80	0.314	2.1	7.35	-0.43	1.04		1.04
16	0.329	1.7	8.85	0.321	2.2	7.43	-0.46	1.08		1.08
17	0.343	1.8	8.96	0.335	2.2	7.51	-0.46	1.15		1.15
18	0.364	1.8	9.13	0.353	2.3	7.63	-0.46	1.18		1.18
19	0.374	1.9	9.15	0.367	2.3	7.68	-0.45	1.20		1.20
20	0.382	1.9	9.20	0.374	2.3	7.71	-0.44	1.16		1.16
21	0.370	1.9	9.21	0.369	2.3	7.69	-0.41	1.06		1.06
22	0.336	1.8	9.01	0.346	2.2	7.50	-0.40	0.90		0.90
23	0.285	1.7	8.72	0.307	2.1	7.22	-0.37	0.78		0.78
24	0.257	1.6	8.39	0.266	1.9	6.93	-0.34	0.74		0.74
25	0.234	1.5	8.10	0.241	1.9	6.80	-0.36	0.69		0.69
26	0.220	1.5	7.84	0.225	1.8	6.64	-0.34	0.66		0.66
27	0.210	1.4	7.67	0.212	1.8	6.53	-0.32	0.67		0.67
28	0.214	1.4	7.61	0.210	1.8	6.53	-0.34	0.75		0.75
29	0.237	1.4	7.75	0.227	1.8	6.69	-0.38	0.89		0.89
30	0.283	1.5	8.27	0.261	2.0	6.99	-0.43	1.10		1.10
31	0.351	1.7	8.87	0.315	2.2	7.44	-0.47	1.25		1.25
32	0.397	1.9	9.19	0.367	2.3	7.72	-0.46	1.12		1.12
33	0.356	1.9	9.16	0.369	2.3	7.67	-0.43	1.17		1.17
34	0.373	1.9	9.10	0.364	2.3	7.67	-0.42	1.13		1.13
35	0.359	1.9	9.04	0.361	2.3	7.62	-0.41	1.12		1.12
36	0.356	1.8	9.01	0.356	2.2	7.57	-0.44	1.10		1.10
37	0.349	1.8	8.97	0.350	2.2	7.55	-0.42	1.09		1.09
38	0.346	1.8	9.02	0.346	2.2	7.54	-0.42	1.08		1.08
39	0.343	1.8	8.98	0.344	2.2	7.54	-0.43	1.11		1.11
40	0.353	1.8	8.98	0.347	2.2	7.57	-0.45	1.07		1.07
41	0.339	1.8	9.06	0.345	2.2	7.53	-0.41	1.15		1.15
42	0.364	1.8	8.95	0.353	2.3	7.59	-0.43	1.12		1.12
43	0.357	1.8	9.01	0.357	2.3	7.59	-0.44	1.14		1.14
44	0.363	1.8	9.00	0.358	2.3	7.62	-0.43	1.12		1.12
45	0.355	1.8	9.06	0.354	2.3	7.60	-0.43	1.01		1.01
46	0.320	1.8	8.98	0.333	2.2	7.43	-0.38	0.90		0.90
47	0.286	1.7	8.59	0.301	2.1	7.21	-0.40	0.81		0.81
Average										
Weekday	0.317	1.7	8.73	0.315	2.1	7.32		1.00	#DIV/0!	1.00
Weekend	0.317	1.7	8.69	0.315	2.1	7.31		1.00	#DIV/0!	1.00
ADWF ⁽¹⁾	0.317	1.7	8.72	0.315	2.1	7.32		1.00	#DIV/0!	1.00
% Error										
Weekday				-0.7%			0.47			
Weekend				-0.7%			0.47			
Note:										

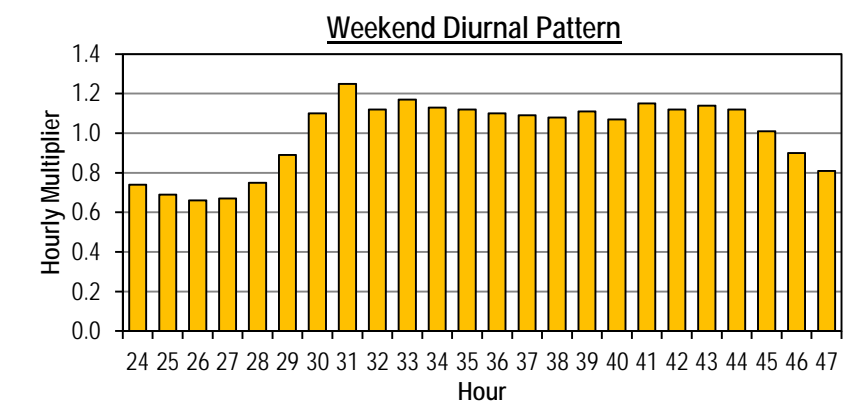
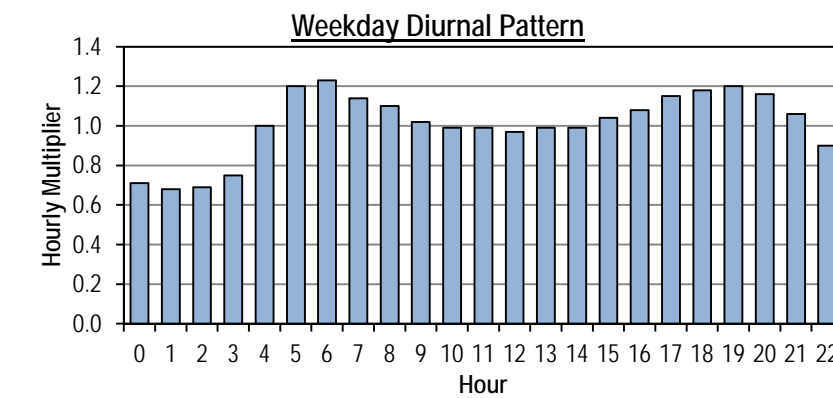
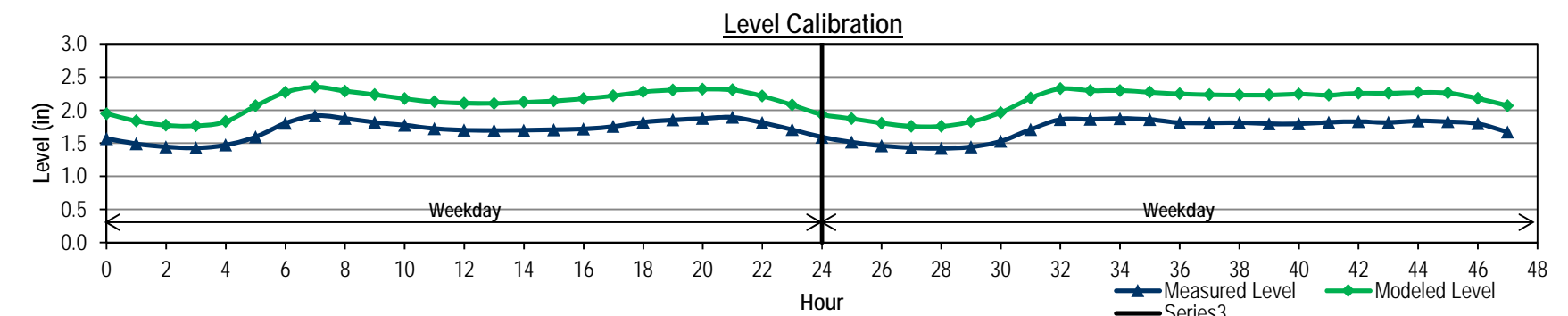
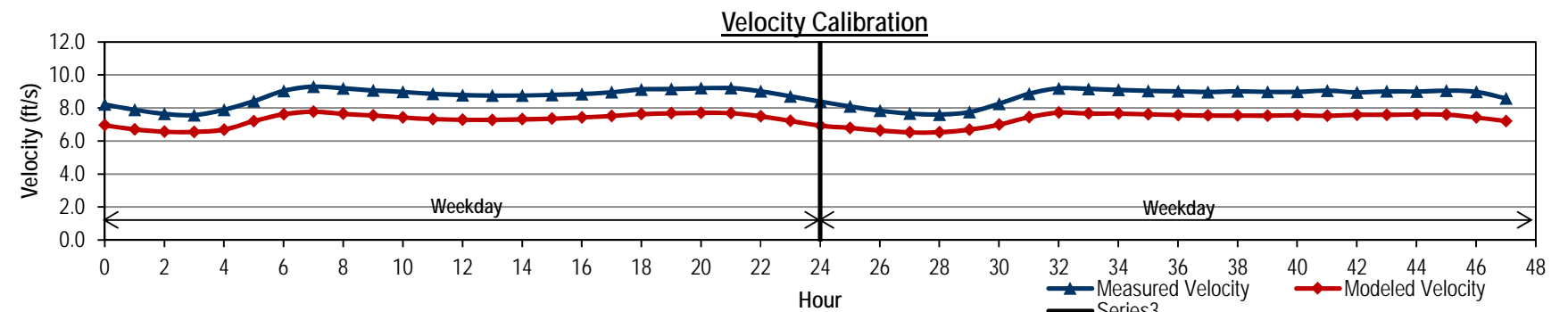
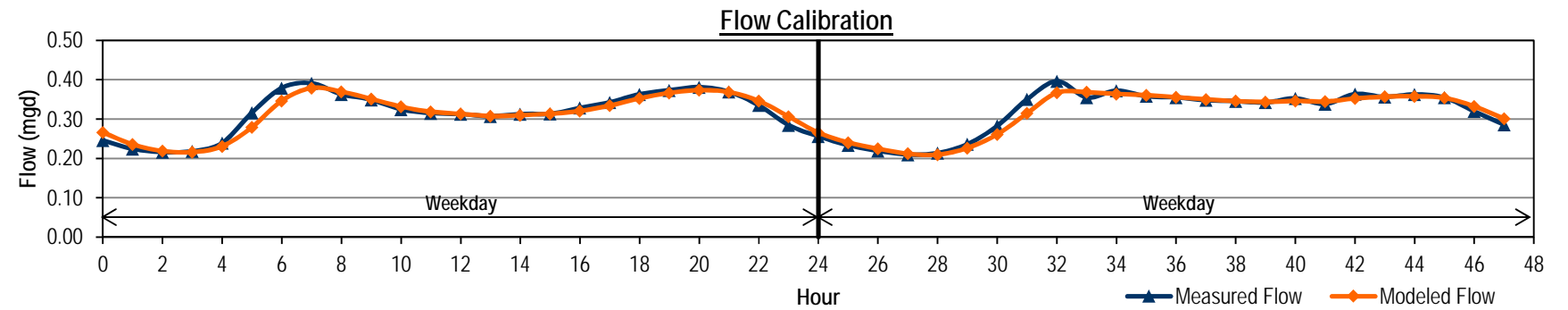



City of Renton
Long-range Wastewater Management Plan
FLOW MONITORING SITE MH1360 DRY WEATHER FLOW CALIBRATION



Hour	Measured Data			Modeled Data			Level Diff (in)	Diurnal		
	Flow (mgd)	Level (in)	Velocity (ft/s)	Flow (mgd)	Level (in)	Velocity (ft/s)		Initial Curve	Modified Curve	Calibrated Diurnal
0	0.140	1.9	3.06	0.166	3.2	1.76	-1.29	0.62		0.62
1	0.128	1.8	2.92	0.156	3.1	1.73	-1.30	0.61		0.61
2	0.126	1.8	2.89	0.153	3.1	1.72	-1.32	0.65		0.65
3	0.135	1.8	2.92	0.160	3.2	1.76	-1.39	0.84		0.84
4	0.173	1.9	3.16	0.188	3.4	1.85	-1.55	1.05		1.05
5	0.215	2.1	3.45	0.221	3.7	1.94	-1.55	1.14		1.14
6	0.234	2.3	3.61	0.240	3.8	1.98	-1.50	1.14		1.14
7	0.234	2.3	3.62	0.243	3.8	1.98	-1.45	1.09		1.09
8	0.224	2.3	3.57	0.237	3.7	1.96	-1.42	1.07		1.07
9	0.221	2.3	3.52	0.231	3.7	1.95	-1.41	1.04		1.04
10	0.214	2.3	3.49	0.224	3.6	1.93	-1.37	1.02		1.02
11	0.211	2.2	3.44	0.219	3.6	1.92	-1.38	1.03		1.03
12	0.213	2.2	3.46	0.216	3.6	1.91	-1.34	1.00		1.00
13	0.207	2.2	3.45	0.212	3.6	1.90	-1.34	0.98		0.98
14	0.203	2.2	3.43	0.213	3.6	1.91	-1.37	1.03		1.03
15	0.213	2.2	3.39	0.224	3.7	1.94	-1.46	1.11		1.11
16	0.228	2.3	3.51	0.236	3.7	1.97	-1.46	1.18		1.18
17	0.242	2.4	3.56	0.248	3.8	2.00	-1.48	1.24		1.24
18	0.254	2.4	3.62	0.258	3.9	2.02	-1.47	1.24		1.24
19	0.255	2.5	3.65	0.260	3.9	2.02	-1.44	1.21		1.21
20	0.248	2.4	3.62	0.254	3.8	2.00	-1.41	1.09		1.09
21	0.224	2.4	3.57	0.234	3.7	1.95	-1.32	0.92		0.92
22	0.189	2.2	3.42	0.207	3.5	1.87	-1.27	0.76		0.76
23	0.157	2.0	3.21	0.183	3.3	1.81	-1.29	0.68		0.68
24	0.148	2.0	3.15	0.166	3.2	1.75	-1.21	0.63		0.63
25	0.130	1.8	3.00	0.153	3.1	1.72	-1.23	0.59		0.59
26	0.122	1.8	2.78	0.147	3.0	1.70	-1.25	0.62		0.62
27	0.127	1.8	2.86	0.146	3.0	1.70	-1.27	0.63		0.63
28	0.131	1.8	2.89	0.151	3.1	1.72	-1.32	0.72		0.72
29	0.148	1.8	3.00	0.163	3.2	1.77	-1.39	0.89		0.89
30	0.183	1.9	3.29	0.192	3.4	1.87	-1.50	1.12		1.12
31	0.230	2.2	3.48	0.232	3.7	1.97	-1.57	1.30		1.30
32	0.268	2.4	3.67	0.261	3.9	2.03	-1.53	1.34		1.34
33	0.276	2.5	3.75	0.269	4.0	2.05	-1.43	1.35		1.35
34	0.278	2.6	3.75	0.267	3.9	2.04	-1.39	1.25		1.25
35	0.258	2.5	3.67	0.257	3.9	2.01	-1.35	1.21		1.21
36	0.250	2.4	3.63	0.248	3.8	1.99	-1.35	1.19		1.19
37	0.245	2.4	3.60	0.244	3.8	1.98	-1.37	1.17		1.17
38	0.241	2.4	3.61	0.244	3.8	1.98	-1.39	1.17		1.17
39	0.240	2.4	3.57	0.241	3.8	1.98	-1.39	1.17		1.17
40	0.240	2.4	3.58	0.241	3.8	1.98	-1.40	1.20		1.20
41	0.247	2.4	3.59	0.241	3.8	1.98	-1.39	1.23		1.23
42	0.253	2.4	3.64	0.246	3.8	1.99	-1.38	1.20		1.20
43	0.248	2.4	3.62	0.247	3.8	1.99	-1.37	1.16		1.16
44	0.239	2.4	3.58	0.239	3.7	1.97	-1.33	1.05		1.05
45	0.217	2.3	3.53	0.218	3.6	1.91	-1.24	0.90		0.90
46	0.186	2.2	3.39	0.196	3.4	1.84	-1.21	0.81		0.81
47	0.167	2.0	3.19	0.178	3.3	1.79	-1.24	0.72		0.72
Average										
Weekday	0.203	2.2	3.40	0.216	3.6	1.91		0.99	#DIV/0!	0.99
Weekend	0.211	2.2	3.41	0.216	3.6	1.90		1.03	#DIV/0!	1.03
ADWF ⁽¹⁾	0.206	2.2	3.40	0.216	3.6	1.91		1.00	#DIV/0!	1.00
% Error										
Weekday				6.1%			1.55			
Weekend				2.4%			1.57			

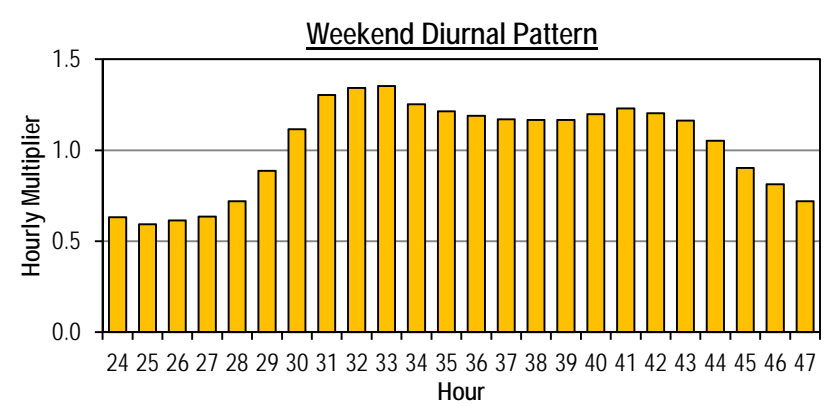
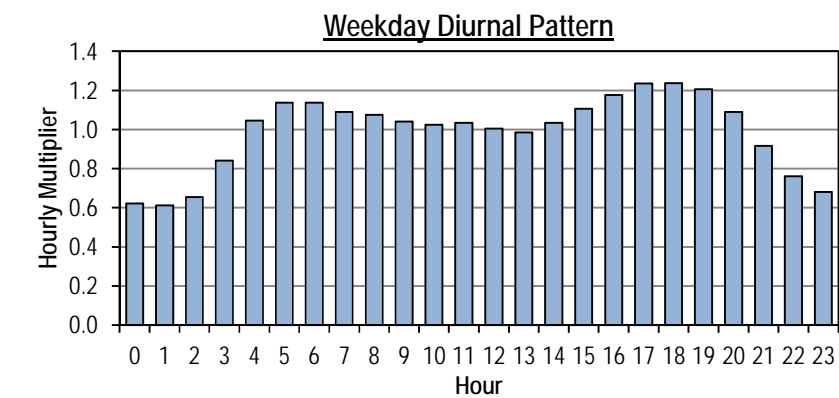
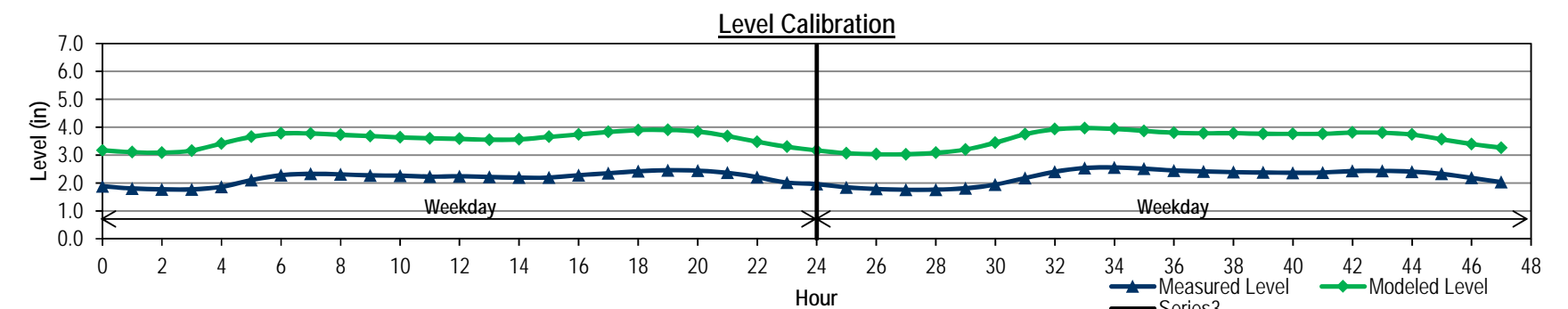
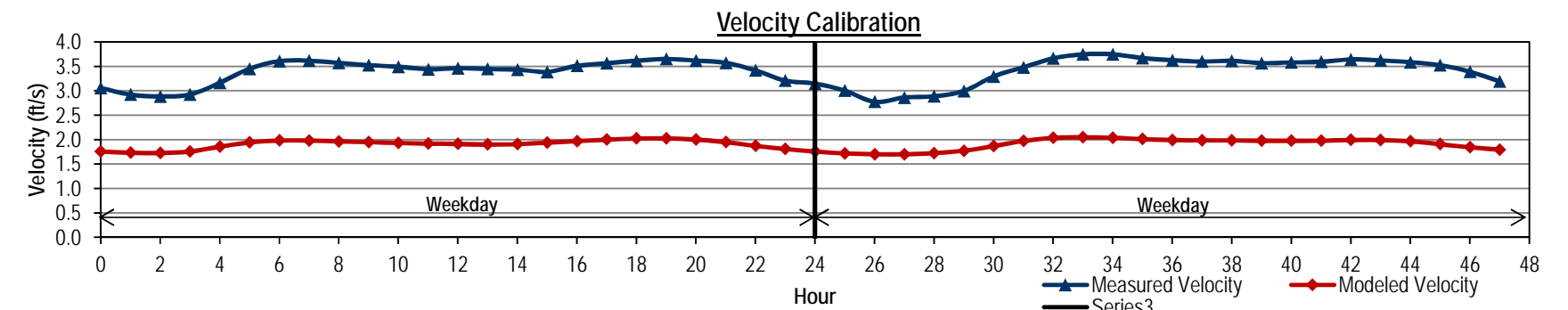
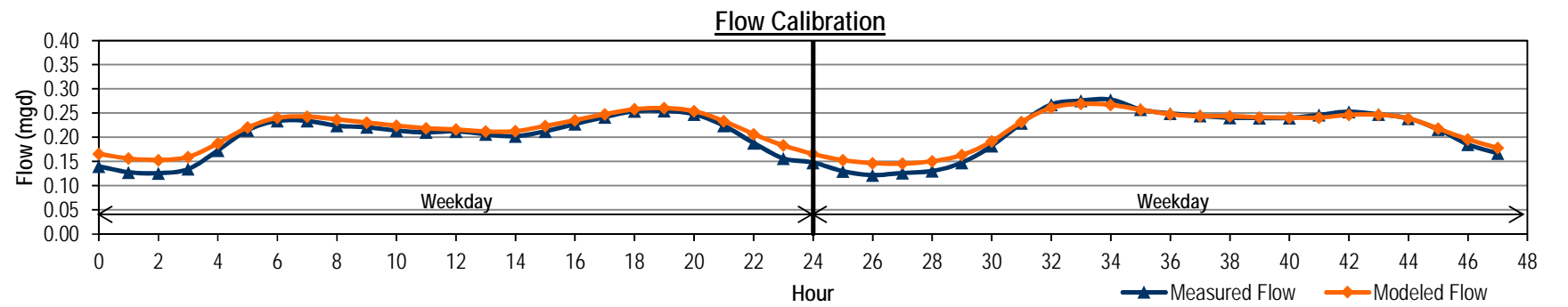



City of Renton
Long-range Wastewater Management Plan
FLOW MONITORING SITE MH1763 DRY WEATHER FLOW CALIBRATION



Hour	Measured Data			Modeled Data			Level Diff (in)	Diurnal		
	Flow (mgd)	Level (in)	Velocity (ft/s)	Flow (mgd)	Level (in)	Velocity (ft/s)		Initial Curve	Modified Curve	Calibrated Diurnal
0	0.113	6.5	0.39	0.149	5.5	0.71	0.95		0.52	
1	0.089	5.7	0.35	0.119	4.8	0.69	0.92		0.44	
2	0.075	5.2	0.32	0.096	4.3	0.65	0.91		0.42	
3	0.072	5.0	0.31	0.083	4.1	0.61	0.83		0.54	
4	0.092	5.0	0.33	0.077	4.3	0.58	0.73		0.76	
5	0.130	5.7	0.40	0.093	5.1	0.58	0.58		1.11	
6	0.189	7.3	0.42	0.127	5.8	0.69	1.48		1.34	
7	0.229	9.2	0.43	0.182	6.5	0.77	2.65		1.35	
8	0.231	10.2	0.40	0.221	6.8	0.84	3.44		1.32	
9	0.225	10.3	0.40	0.234	6.7	0.85	3.59		1.23	
10	0.210	9.9	0.39	0.221	6.7	0.83	3.22		1.13	
11	0.193	9.3	0.39	0.207	6.5	0.82	2.81		1.08	
12	0.184	8.8	0.39	0.200	6.5	0.77	2.31		1.00	
13	0.170	8.3	0.40	0.181	6.3	0.77	2.00		0.91	
14	0.156	7.8	0.40	0.168	6.3	0.72	1.46		0.93	
15	0.159	7.5	0.39	0.162	6.2	0.72	1.33		1.00	
16	0.170	7.5	0.42	0.163	6.3	0.71	1.22		1.07	
17	0.182	7.7	0.43	0.172	6.5	0.72	1.22		1.17	
18	0.199	8.1	0.44	0.185	6.8	0.74	1.36		1.25	
19	0.212	8.5	0.44	0.201	6.9	0.77	1.61		1.27	
20	0.216	8.8	0.45	0.214	6.9	0.80	1.91		1.18	
21	0.200	8.7	0.44	0.214	6.8	0.80	1.89		1.01	
22	0.171	8.2	0.42	0.195	6.5	0.78	1.69		0.84	
23	0.143	7.4	0.40	0.176	6.1	0.74	1.27		0.66	
24	0.140	6.8	0.45	0.141	5.5	0.72	1.28		0.66	
25	0.112	6.0	0.42	0.127	4.9	0.70	1.11		0.57	
26	0.097	5.3	0.40	0.107	4.3	0.72	1.06		0.50	
27	0.085	5.0	0.38	0.096	4.0	0.70	0.99		0.51	
28	0.087	4.8	0.37	0.087	3.9	0.67	0.93		0.70	
29	0.120	5.6	0.37	0.087	3.9	0.70	1.64		0.98	
30	0.168	7.3	0.38	0.109	4.6	0.74	2.71		1.19	
31	0.202	8.5	0.39	0.149	5.5	0.79	3.06		1.48	
32	0.252	9.8	0.41	0.197	6.6	0.80	3.27		1.59	
33	0.270	10.7	0.44	0.235	7.1	0.84	3.67		1.58	
34	0.270	10.6	0.46	0.253	7.4	0.85	3.19		1.40	
35	0.239	10.0	0.47	0.246	7.3	0.84	2.73		1.28	
36	0.217	9.3	0.44	0.225	7.1	0.80	2.19		1.15	
37	0.196	8.8	0.43	0.203	6.9	0.77	1.95		1.08	
38	0.184	8.5	0.40	0.188	6.7	0.74	1.84		1.06	
39	0.180	8.3	0.41	0.177	6.6	0.71	1.67		1.08	
40	0.184	8.2	0.40	0.172	6.5	0.72	1.62		1.13	
41	0.192	8.2	0.42	0.175	6.7	0.72	1.53		1.11	
42	0.189	8.3	0.42	0.179	6.6	0.73	1.68		1.16	
43	0.197	8.4	0.42	0.181	6.8	0.72	1.59		1.20	
44	0.204	8.6	0.44	0.186	6.8	0.74	1.80		1.06	
45	0.180	8.5	0.42	0.186	6.7	0.74	1.77		0.95	
46	0.162	7.9	0.40	0.171	6.3	0.73	1.67		0.91	
47	0.155	7.2	0.41	0.159	5.9	0.72	1.30		0.82	
Average										
Weekday	0.167	7.8	0.40	0.168	6.1	0.74		0.98	#DIV/0!	0.98
Weekend	0.178	7.9	0.41	0.168	6.0	0.75		1.05	#DIV/0!	1.05
ADWF ⁽¹⁾	0.170	7.8	0.40	0.168	6.0	0.74		1.00	#DIV/0!	1.00
% Error										
Weekday				0.9%			3.59			
Weekend				-5.6%			3.67			

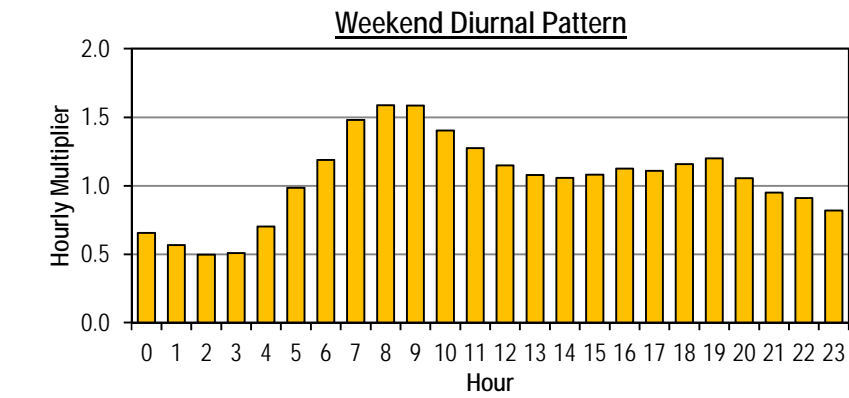
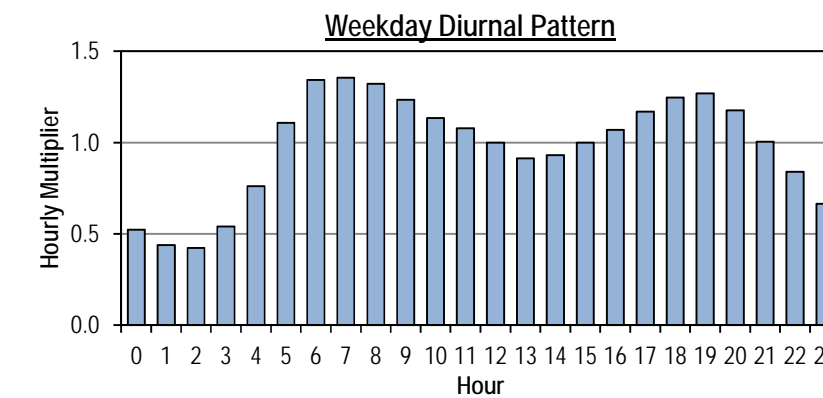
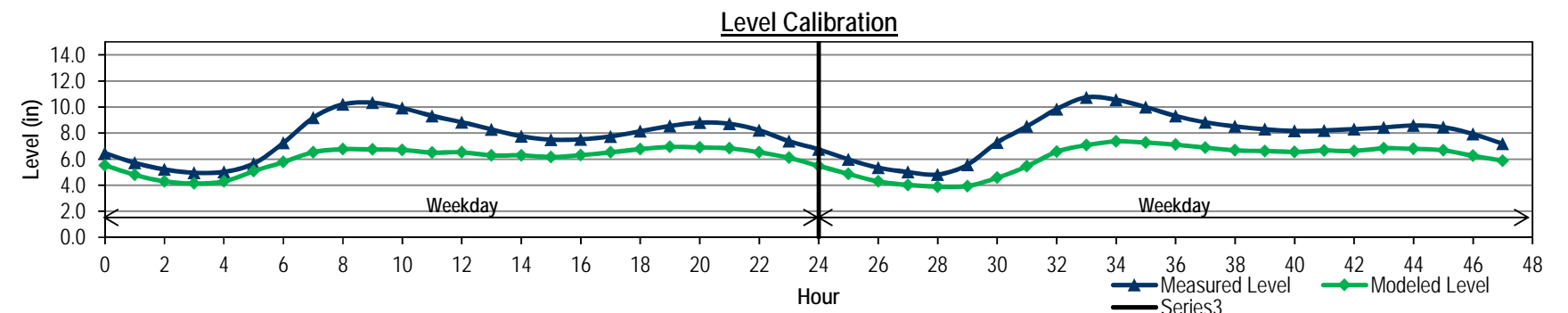
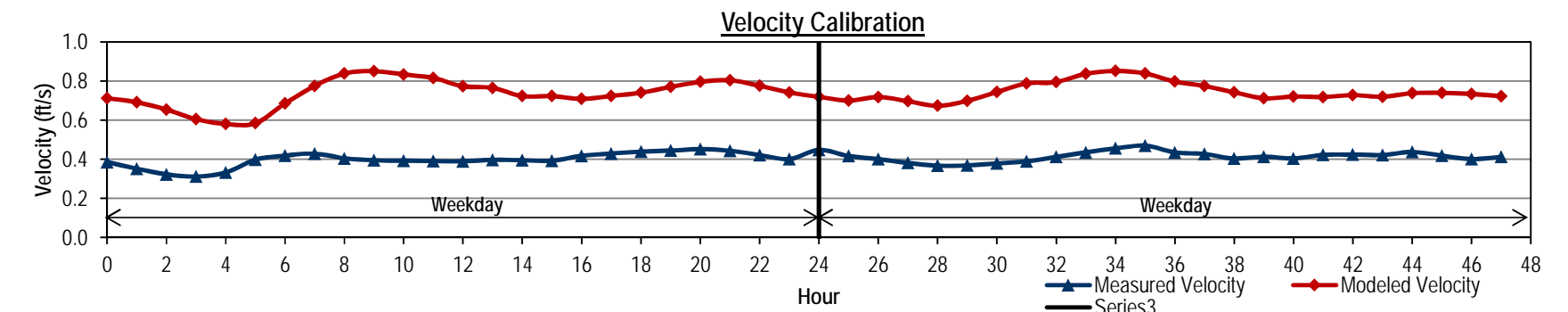
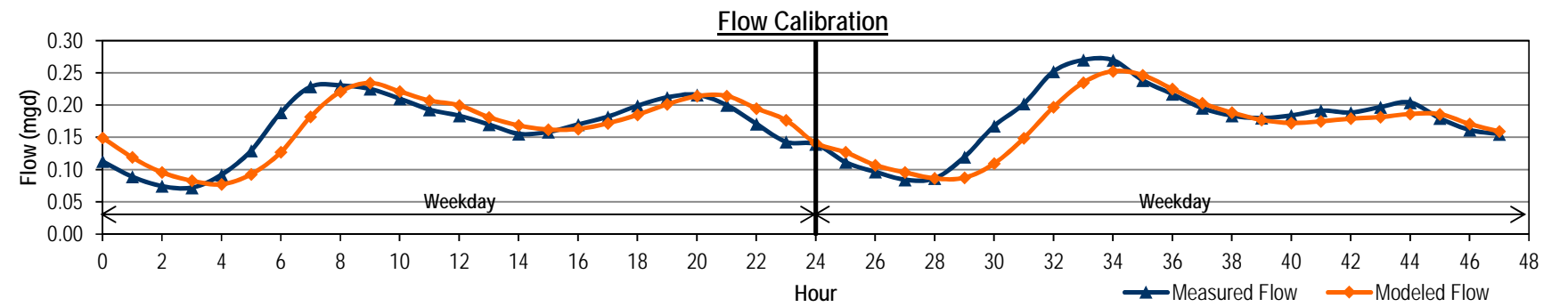

Note:



**City of Renton
Long-range Wastewater Management Plan
FLOW MONITORING SITE MH2116 DRY WEATHER FLOW CALIBRATION**



Hour	Measured Data			Modeled Data			Level Diff (in)	Diurnal		
	Flow (mgd)	Level (in)	Velocity (ft/s)	Flow (mgd)	Level (in)	Velocity (ft/s)		Initial Curve	Modified Curve	Calibrated Diurnal
0	0.439	4.1	2.66	0.399	4.8	2.46	-0.74	0.74		0.74
1	0.422	4.0	2.59	0.385	4.6	2.40	-0.68	0.72		0.72
2	0.414	3.9	2.56	0.344	4.9	2.50	-0.98	0.75		0.75
3	0.432	3.9	2.59	0.405	4.6	2.37	-0.65	0.85		0.85
4	0.485	4.1	2.65	0.377	4.8	2.44	-0.73	0.98		0.98
5	0.560	4.3	2.78	0.427	5.1	2.52	-0.82	1.09		1.09
6	0.624	4.6	2.94	0.482	5.5	2.57	-0.90	1.11		1.11
7	0.639	4.8	2.97	0.537	5.8	2.62	-1.01	1.12		1.12
8	0.640	4.8	2.96	0.585	6.1	2.71	-1.33	1.11		1.11
9	0.639	4.8	2.97	0.588	6.2	2.66	-1.36	1.11		1.11
10	0.639	4.8	2.97	0.648	6.0	2.64	-1.20	1.09		1.09
11	0.626	4.8	2.96	0.584	6.3	2.69	-1.54	1.09		1.09
12	0.623	4.8	2.95	0.570	6.0	2.64	-1.20	1.08		1.08
13	0.618	4.7	2.94	0.625	5.9	2.63	-1.16	1.05		1.05
14	0.604	4.7	2.93	0.565	6.2	2.67	-1.50	1.07		1.07
15	0.613	4.7	2.94	0.553	5.9	2.62	-1.23	1.10		1.10
16	0.629	4.7	2.96	0.559	5.9	2.63	-1.17	1.13		1.13
17	0.648	4.8	2.98	0.615	5.9	2.64	-1.14	1.13		1.13
18	0.648	4.8	2.98	0.633	6.2	2.71	-1.36	1.12		1.12
19	0.644	4.8	2.98	0.595	6.2	2.66	-1.36	1.08		1.08
20	0.617	4.8	2.96	0.561	5.9	2.63	-1.11	1.00		1.00
21	0.573	4.6	2.90	0.526	5.6	2.60	-1.01	0.91		0.91
22	0.523	4.5	2.83	0.559	5.8	2.65	-1.35	0.84		0.84
23	0.483	4.2	2.72	0.484	5.4	2.55	-1.15	0.77		0.77
24	0.447	4.1	2.67	0.444	5.2	2.52	-1.06	0.70		0.70
25	0.403	3.9	2.58	0.353	4.6	2.37	-0.66	0.69		0.69
26	0.398	3.8	2.56	0.332	4.4	2.33	-0.60	0.70		0.70
27	0.403	3.8	2.53	0.321	4.4	2.32	-0.58	0.69		0.69
28	0.397	3.8	2.56	0.319	4.4	2.31	-0.52	0.76		0.76
29	0.434	3.8	2.56	0.345	4.8	2.44	-1.01	0.90		0.90
30	0.518	4.1	2.72	0.395	4.9	2.48	-0.84	1.07		1.07
31	0.615	4.4	2.91	0.469	5.4	2.56	-0.97	1.16		1.16
32	0.664	4.8	3.00	0.537	5.9	2.65	-1.08	1.25		1.25
33	0.716	5.1	3.03	0.618	6.3	2.72	-1.27	1.24		1.24
34	0.714	5.2	3.03	0.737	6.6	2.71	-1.40	1.21		1.21
35	0.692	5.1	3.03	0.673	6.8	2.75	-1.75	1.20		1.20
36	0.686	5.0	3.02	0.678	6.8	2.78	-1.83	1.16		1.16
37	0.663	4.9	3.00	0.682	6.7	2.78	-1.75	1.15		1.15
38	0.660	4.9	3.01	0.687	6.3	2.71	-1.47	1.13		1.13
39	0.650	4.8	3.00	0.681	6.2	2.67	-1.41	1.12		1.12
40	0.644	4.8	3.01	0.615	6.4	2.69	-1.59	1.13		1.13
41	0.646	4.8	2.99	0.608	6.1	2.65	-1.25	1.13		1.13
42	0.646	4.8	3.00	0.632	6.4	2.71	-1.61	1.10		1.10
43	0.633	4.8	3.00	0.583	6.0	2.64	-1.24	1.02		1.02
44	0.585	4.7	2.94	0.556	5.8	2.62	-1.11	0.96		0.96
45	0.553	4.5	2.89	0.562	6.0	2.64	-1.41	0.87		0.87
46	0.497	4.3	2.77	0.478	5.4	2.56	-1.06	0.80		0.80
47	0.457	4.2	2.67	0.433	5.1	2.52	-0.95	0.78		0.78
Average										
Weekday	0.574	4.5	2.86	0.525	5.7	2.59		1.00	#DIV/0!	1.00
Weekend	0.572	4.5	2.85	0.531	5.7	2.59		1.00	#DIV/0!	1.00
ADWF ⁽¹⁾	0.573	4.5	2.86	0.527	5.7	2.59		1.00	#DIV/0!	1.00
% Error										
Weekday				-8.5%			1.54			
Weekend				-7.1%			1.83			

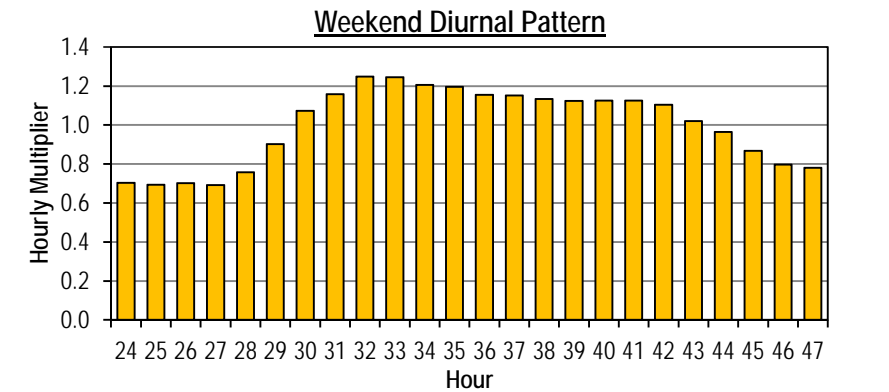
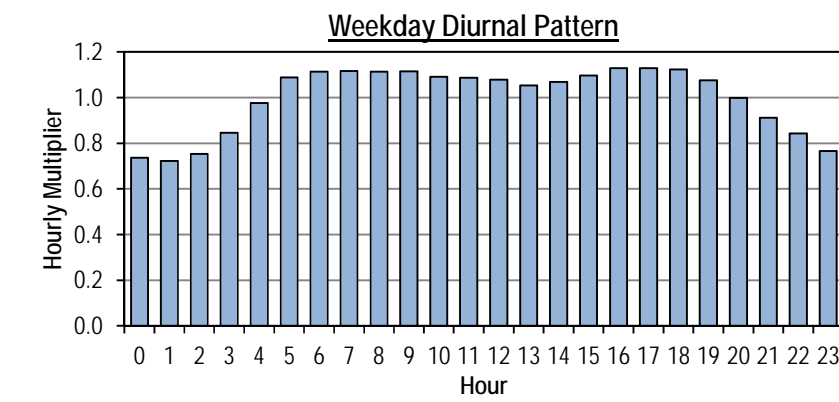
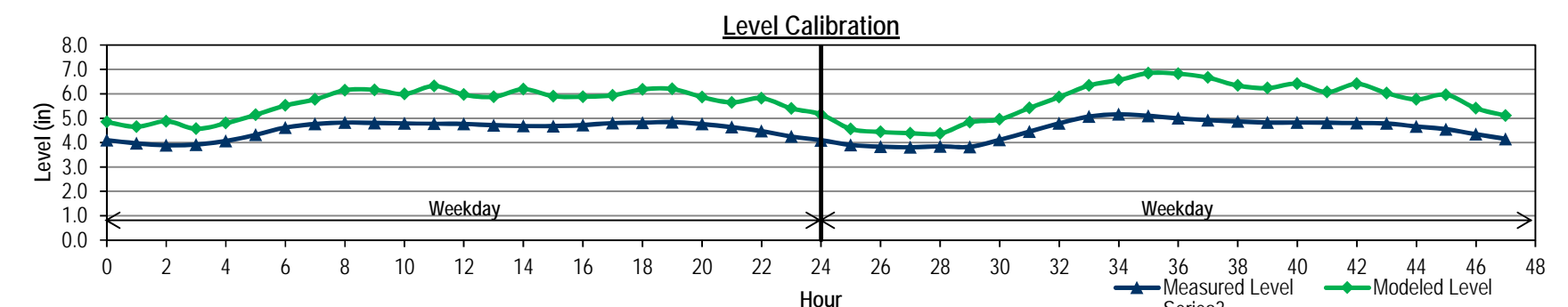
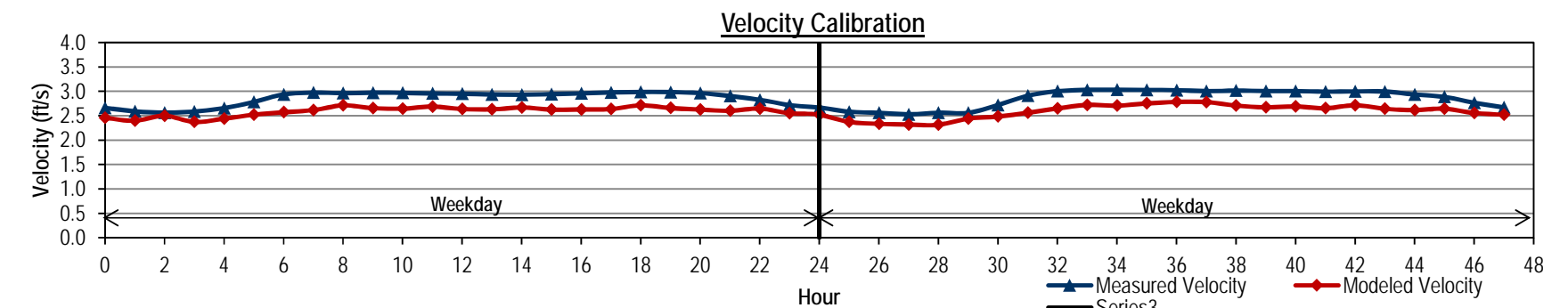
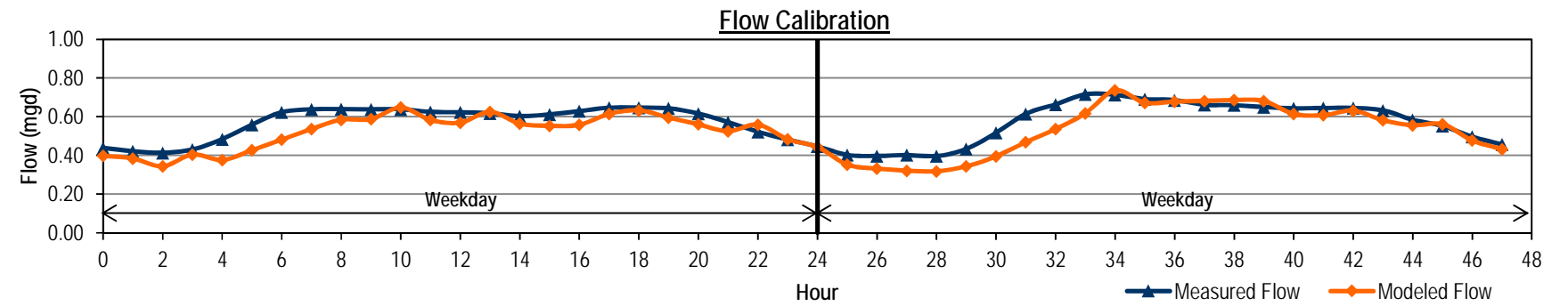

Note:



**City of Renton
Long-range Wastewater Management Plan
FLOW MONITORING SITE MH2171 DRY WEATHER FLOW CALIBRATION**



Hour	Measured Data			Modeled Data			Level Diff (in)	Diurnal		
	Flow (mgd)	Level (in)	Velocity (ft/s)	Flow (mgd)	Level (in)	Velocity (ft/s)		Initial Curve	Modified Curve	Calibrated Diurnal
0	0.101	3.2	1.00	0.101	3.4	1.12	-0.22	0.55	0.52	0.55
1	0.095	3.1	0.97	0.097	3.4	1.11	-0.26	0.59	0.56	0.59
2	0.103	3.0	0.96	0.110	3.6	1.16	-0.58	0.95	0.89	0.95
3	0.165	3.5	1.09	0.160	4.5	1.26	-1.01	0.99	0.93	0.99
4	0.171	3.9	1.23	0.179	4.7	1.29	-0.84	1.28	1.21	1.28
5	0.223	4.1	1.27	0.226	5.4	1.37	-1.30	1.54	1.46	1.54
6	0.268	4.6	1.44	0.266	5.8	1.42	-1.19	1.60	1.51	1.60
7	0.278	4.9	1.50	0.273	5.9	1.43	-1.03	1.52	1.44	1.52
8	0.264	4.8	1.49	0.260	5.7	1.41	-0.92	1.41	1.33	1.41
9	0.244	4.7	1.43	0.240	5.5	1.38	-0.84	1.28	1.21	1.28
10	0.223	4.5	1.39	0.220	5.2	1.35	-0.74	1.21	1.15	1.21
11	0.211	4.3	1.34	0.210	5.1	1.34	-0.78	1.22	1.15	1.22
12	0.212	4.3	1.33	0.210	5.1	1.34	-0.86	1.19	1.12	1.19
13	0.206	4.3	1.32	0.207	5.1	1.34	-0.83	1.24	1.17	1.24
14	0.215	4.3	1.32	0.211	5.1	1.34	-0.86	1.14	1.07	1.14
15	0.197	4.3	1.32	0.199	5.0	1.32	-0.72	1.18	1.11	1.18
16	0.204	4.2	1.30	0.199	5.0	1.32	-0.79	1.05	0.99	1.05
17	0.183	4.2	1.30	0.179	4.7	1.28	-0.53	0.93	0.88	0.93
18	0.161	3.9	1.20	0.163	4.5	1.26	-0.57	0.95	0.90	0.95
19	0.165	3.9	1.20	0.163	4.5	1.26	-0.60	0.91	0.86	0.91
20	0.159	3.9	1.19	0.156	4.4	1.24	-0.51	0.84	0.79	0.84
21	0.146	3.8	1.17	0.143	4.2	1.21	-0.39	0.73	0.69	0.73
22	0.126	3.6	1.11	0.126	3.9	1.17	-0.31	0.65	0.61	0.65
23	0.112	3.4	1.05	0.112	3.6	1.14	-0.28	0.58	0.55	0.58
24	0.113	3.3	1.06	0.102	3.4	1.12	-0.12	0.61	0.72	0.61
25	0.106	3.2	1.03	0.105	3.5	1.13	-0.30	0.59	0.70	0.59
26	0.102	3.2	1.00	0.102	3.5	1.12	-0.30	0.57	0.68	0.57
27	0.099	3.1	0.99	0.099	3.4	1.11	-0.30	0.58	0.69	0.58
28	0.100	3.1	0.99	0.101	3.5	1.12	-0.36	0.63	0.75	0.63
29	0.110	3.2	1.00	0.111	3.6	1.15	-0.49	0.73	0.87	0.73
30	0.127	3.3	1.05	0.129	4.0	1.19	-0.62	0.88	1.05	0.88
31	0.153	3.6	1.12	0.154	4.4	1.25	-0.75	1.01	1.21	1.01
32	0.176	3.9	1.22	0.175	4.7	1.28	-0.76	1.08	1.29	1.08
33	0.188	4.0	1.26	0.185	4.8	1.30	-0.76	1.05	1.25	1.05
34	0.182	4.1	1.28	0.181	4.7	1.29	-0.65	1.01	1.21	1.01
35	0.176	4.0	1.26	0.174	4.6	1.28	-0.64	0.97	1.16	0.97
36	0.169	3.9	1.24	0.168	4.5	1.27	-0.62	0.96	1.14	0.96
37	0.166	3.9	1.22	0.166	4.5	1.26	-0.63	0.95	1.13	0.95
38	0.165	3.9	1.22	0.164	4.5	1.26	-0.62	0.94	1.12	0.94
39	0.163	3.8	1.21	0.163	4.5	1.26	-0.62	0.93	1.11	0.93
40	0.162	3.8	1.21	0.161	4.4	1.25	-0.59	0.93	1.11	0.93
41	0.161	3.8	1.21	0.162	4.5	1.26	-0.64	0.97	1.15	0.97
42	0.168	3.9	1.20	0.168	4.5	1.27	-0.67	0.98	1.17	0.98
43	0.170	3.9	1.22	0.167	4.5	1.26	-0.61	0.91	1.09	0.91
44	0.159	3.9	1.22	0.156	4.4	1.24	-0.49	0.83	0.99	0.83
45	0.144	3.7	1.17	0.142	4.1	1.21	-0.40	0.74	0.88	0.74
46	0.129	3.6	1.12	0.128	3.9	1.18	-0.35	0.69	0.82	0.69
47	0.120	3.4	1.06	0.119	3.8	1.16	-0.36	0.65	0.77	0.65
Average										
Weekday	0.184	4.0	1.25	0.184	4.7	1.29		1.06	1.00	1.06
Weekend	0.146	3.6	1.15	0.145	4.2	1.22		0.84	1.00	0.84
ADWF ⁽¹⁾	0.173	3.9	1.22	0.173	4.6	1.27		1.00	1.00	1.00
% Error										
Weekday				-0.4%			1.30			
Weekend				-0.5%			0.76			

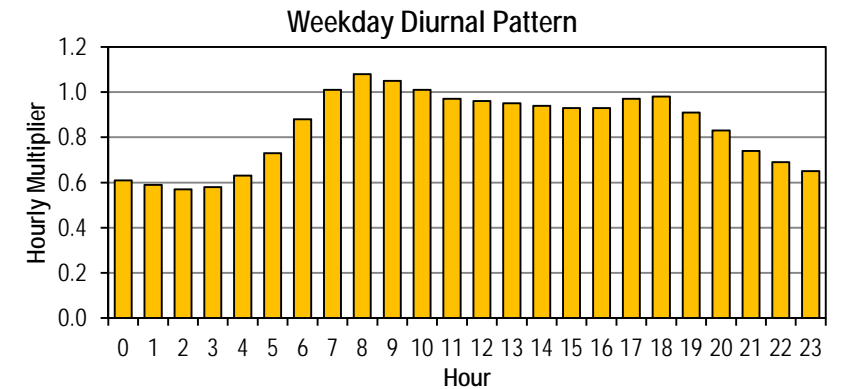
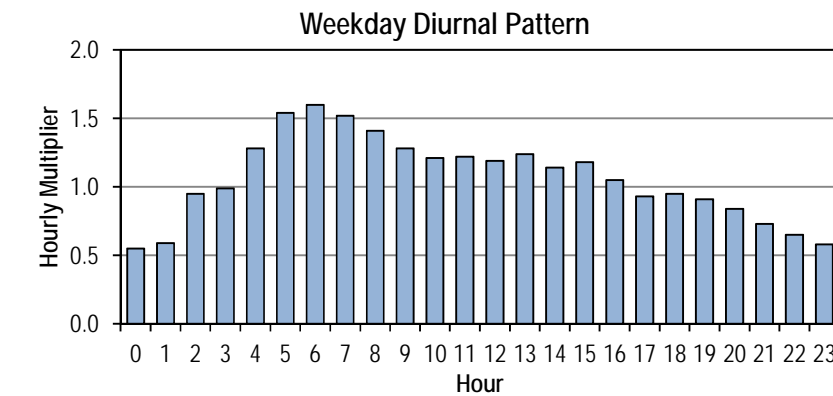
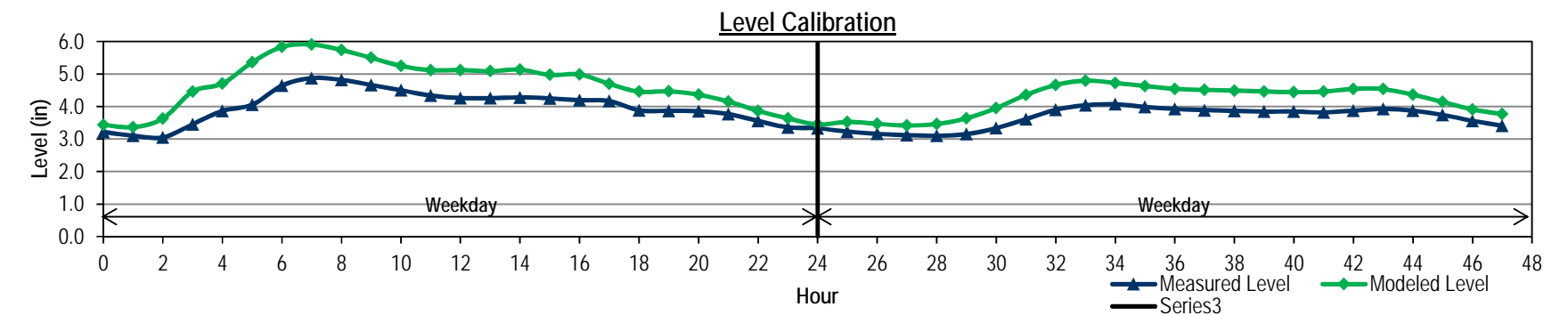
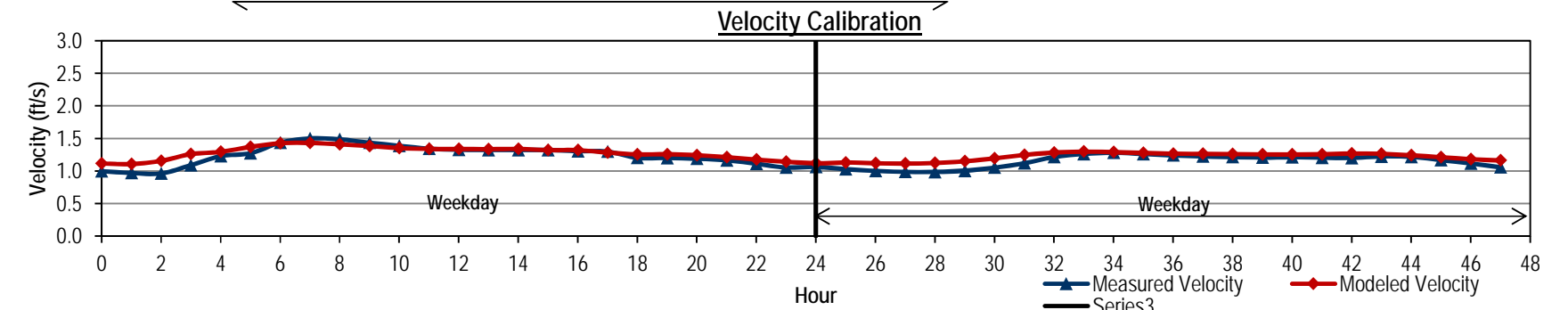
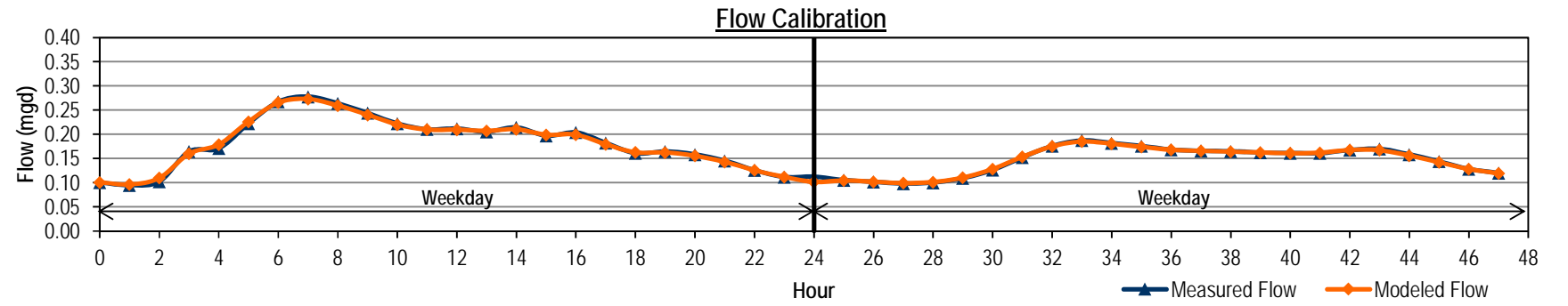



City of Renton
Long-range Wastewater Management Plan
FLOW MONITORING SITE MH2252 DRY WEATHER FLOW CALIBRATION



Hour	Measured Data			Modeled Data			Level Diff (in)	Diurnal		
	Flow (mgd)	Level (in)	Velocity (ft/s)	Flow (mgd)	Level (in)	Velocity (ft/s)		Initial Curve	Modified Curve	Calibrated Diurnal
0	0.457	2.8	4.13	0.474	2.9	2.54	-0.04	0.66		0.66
1	0.434	2.8	3.97	0.443	2.8	2.50	-0.06	0.66		0.66
2	0.433	2.7	3.96	0.435	2.8	2.49	-0.07	0.67		0.67
3	0.438	2.7	3.95	0.440	2.8	2.50	-0.08	0.74		0.74
4	0.483	2.8	4.00	0.479	2.9	2.58	-0.16	0.93		0.93
5	0.611	3.0	4.31	0.590	3.2	2.74	-0.21	1.09		1.09
6	0.711	3.3	4.68	0.688	3.4	2.87	-0.12	1.09		1.09
7	0.716	3.4	4.83	0.715	3.5	2.88	-0.07	1.08		1.08
8	0.710	3.4	4.82	0.712	3.5	2.88	-0.09	1.08		1.08
9	0.707	3.4	4.78	0.710	3.5	2.88	-0.10	1.09		1.09
10	0.714	3.4	4.81	0.713	3.5	2.88	-0.10	1.07		1.07
11	0.702	3.4	4.80	0.705	3.5	2.87	-0.09	1.05		1.05
12	0.685	3.3	4.79	0.689	3.4	2.85	-0.10	1.02		1.02
13	0.667	3.3	4.74	0.672	3.4	2.83	-0.10	1.00		1.00
14	0.658	3.2	4.68	0.663	3.4	2.82	-0.12	1.04		1.04
15	0.683	3.3	4.71	0.680	3.4	2.85	-0.13	1.08		1.08
16	0.706	3.3	4.78	0.705	3.5	2.88	-0.13	1.14		1.14
17	0.750	3.4	4.83	0.746	3.5	2.92	-0.15	1.23		1.23
18	0.805	3.5	4.97	0.797	3.6	2.98	-0.14	1.28		1.28
19	0.837	3.6	5.11	0.829	3.7	3.02	-0.11	1.22		1.22
20	0.800	3.6	5.12	0.802	3.6	2.98	-0.05	1.09		1.09
21	0.716	3.5	4.97	0.727	3.5	2.88	-0.02	0.93		0.93
22	0.608	3.2	4.69	0.628	3.3	2.75	-0.01	0.79		0.79
23	0.517	3.0	4.39	0.538	3.0	2.63	-0.02	0.70		0.70
24	0.445	2.8	4.09	0.471	2.9	2.53	-0.05	0.62		0.62
25	0.405	2.7	3.91	0.411	2.7	2.43	-0.02	0.60		0.60
26	0.392	2.6	3.83	0.383	2.6	2.40	-0.01	0.60		0.60
27	0.391	2.6	3.80	0.377	2.6	2.39	-0.01	0.60		0.60
28	0.395	2.6	3.80	0.381	2.6	2.40	-0.02	0.65		0.65
29	0.428	2.6	3.87	0.409	2.7	2.46	-0.10	0.81		0.81
30	0.534	2.8	4.11	0.496	3.0	2.62	-0.19	1.09		1.09
31	0.714	3.1	4.62	0.655	3.4	2.84	-0.23	1.31		1.31
32	0.855	3.5	5.03	0.798	3.6	3.00	-0.13	1.40		1.40
33	0.918	3.7	5.24	0.872	3.8	3.06	-0.04	1.41		1.41
34	0.927	3.8	5.34	0.888	3.8	3.07	-0.02	1.37		1.37
35	0.900	3.8	5.32	0.868	3.8	3.05	-0.01	1.32		1.32
36	0.862	3.7	5.26	0.834	3.7	3.01	-0.03	1.24		1.24
37	0.814	3.6	5.16	0.792	3.6	2.97	-0.03	1.20		1.20
38	0.788	3.5	5.05	0.763	3.6	2.93	-0.05	1.17		1.17
39	0.766	3.5	5.02	0.742	3.5	2.91	-0.04	1.15		1.15
40	0.754	3.4	4.93	0.730	3.5	2.90	-0.06	1.17		1.17
41	0.764	3.5	4.94	0.736	3.5	2.91	-0.06	1.21		1.21
42	0.790	3.5	4.97	0.756	3.6	2.93	-0.07	1.23		1.23
43	0.804	3.5	5.04	0.768	3.6	2.95	-0.04	1.17		1.17
44	0.767	3.5	5.02	0.739	3.5	2.90	0.00	1.03		1.03
45	0.676	3.4	4.86	0.664	3.3	2.80	0.06	0.89		0.89
46	0.582	3.2	4.58	0.578	3.1	2.69	0.03	0.76		0.76
47	0.501	3.0	4.34	0.500	3.0	2.58	0.01	0.68		0.68
Average										
Weekday	0.648	3.2	4.62	0.649	3.3	2.79		0.99	#DIV/0!	0.99
Weekend	0.674	3.3	4.67	0.650	3.3	2.78		1.03	#DIV/0!	1.03
ADWF ⁽¹⁾	0.655	3.2	4.63	0.649	3.3	2.79		1.00	#DIV/0!	1.00
% Error										
Weekday				0.2%			0.21			
Weekend				-3.4%			0.23			
Note:										

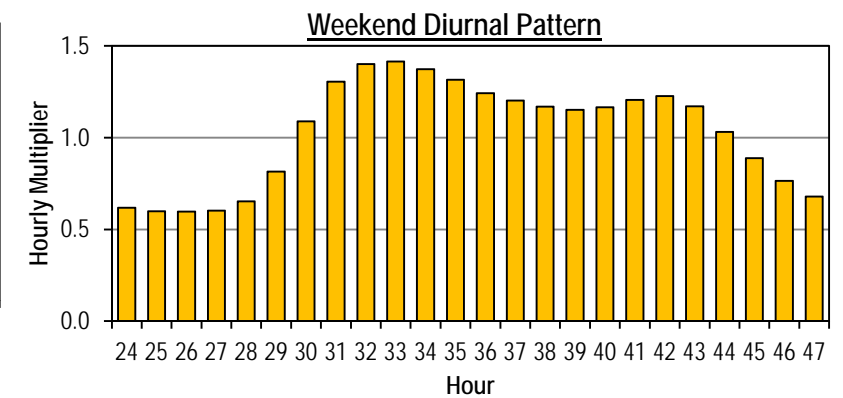
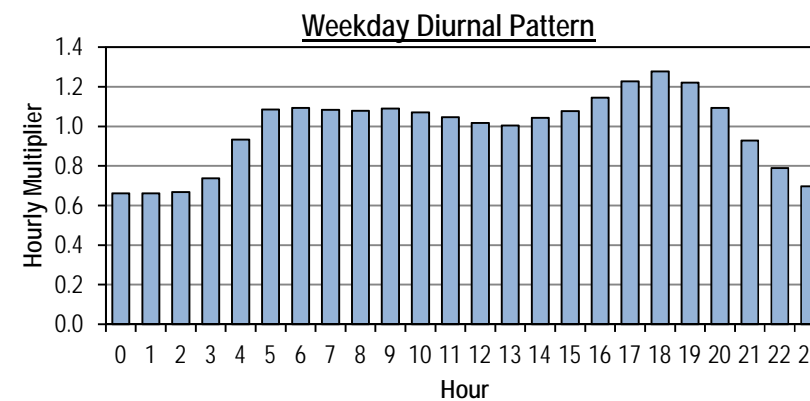
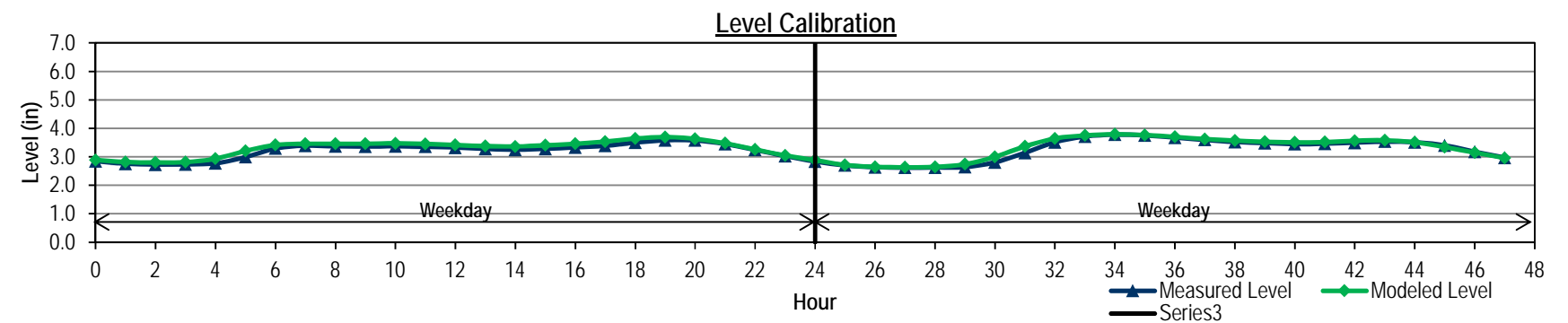
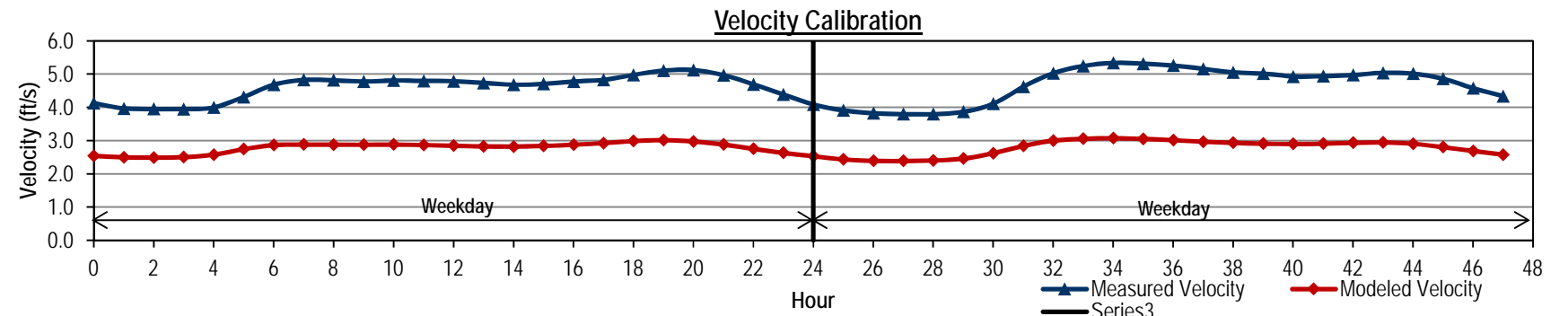
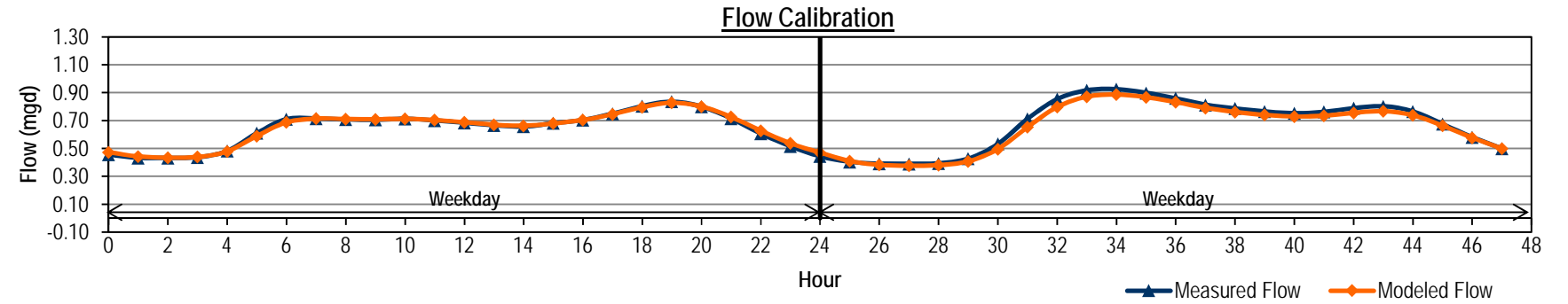



City of Renton
Long-range Wastewater Management Plan
FLOW MONITORING SITE MH2999 DRY WEATHER FLOW CALIBRATION



Hour	Measured Data			Modeled Data				Level Diff (in)	Diurnal		
	Flow (mgd)	Level (in)	Velocity (ft/s)	Flow (mgd)	Level (in)	Velocity (ft/s)	Initial Curve		Modified Curve	Calibrated Diurnal	
0	0.136	1.5	4.78	0.070	1.4	3.19	0.08	0.71		0.71	
1	0.126	1.5	4.64	0.065	1.4	3.13	0.09	0.71		0.71	
2	0.126	1.4	4.53	0.065	1.4	3.17	0.05	0.78		0.78	
3	0.139	1.5	4.72	0.070	1.4	3.23	0.03	0.86		0.86	
4	0.153	1.5	4.86	0.081	1.5	3.33	-0.01	1.01		1.01	
5	0.179	1.6	5.20	0.096	1.6	3.41	0.04	1.08		1.08	
6	0.193	1.7	5.34	0.187	2.2	4.25	-0.57	1.12		1.12	
7	0.199	1.7	5.49	0.212	2.3	4.28	-0.55	1.14		1.14	
8	0.204	1.7	5.51	0.200	2.3	4.31	-0.57	1.08		1.08	
9	0.193	1.7	5.48	0.189	2.4	4.43	-0.71	1.04		1.04	
10	0.186	1.7	5.40	0.179	2.3	4.24	-0.56	1.00		1.00	
11	0.178	1.7	5.31	0.174	2.2	4.16	-0.53	1.00		1.00	
12	0.178	1.6	5.30	0.188	2.2	4.15	-0.53	0.97		0.97	
13	0.173	1.6	5.25	0.193	2.1	4.12	-0.52	0.97		0.97	
14	0.172	1.6	5.26	0.187	2.1	4.11	-0.52	1.00		1.00	
15	0.179	1.6	5.29	0.185	2.2	4.21	-0.57	1.06		1.06	
16	0.189	1.7	5.34	0.187	2.4	4.41	-0.75	1.09		1.09	
17	0.194	1.7	5.41	0.188	2.3	4.30	-0.61	1.13		1.13	
18	0.201	1.7	5.54	0.193	2.3	4.30	-0.55	1.17		1.17	
19	0.208	1.8	5.56	0.221	2.3	4.35	-0.59	1.12		1.12	
20	0.200	1.7	5.50	0.211	2.4	4.43	-0.69	1.02		1.02	
21	0.182	1.7	5.46	0.185	2.2	4.20	-0.49	0.92		0.92	
22	0.165	1.6	5.21	0.165	2.1	4.06	-0.48	0.81		0.81	
23	0.144	1.5	5.00	0.148	2.0	3.92	-0.43	0.76		0.76	
24	0.147	1.5	4.88	0.142	1.9	3.85	-0.39	0.73		0.73	
25	0.131	1.5	4.74	0.143	1.9	3.86	-0.44	0.75		0.75	
26	0.134	1.5	4.63	0.120	1.9	3.83	-0.42	0.74		0.74	
27	0.131	1.5	4.64	0.120	1.8	3.74	-0.36	0.79		0.79	
28	0.140	1.5	4.72	0.128	1.9	3.80	-0.39	0.83		0.83	
29	0.148	1.5	4.85	0.143	1.9	3.87	-0.43	0.99		0.99	
30	0.176	1.6	5.07	0.170	2.1	4.07	-0.52	1.18		1.18	
31	0.210	1.7	5.43	0.193	2.3	4.27	-0.56	1.29		1.29	
32	0.230	1.8	5.68	0.206	2.5	4.54	-0.68	1.29		1.29	
33	0.230	1.9	5.74	0.211	2.4	4.43	-0.55	1.26		1.26	
34	0.225	1.9	5.69	0.228	2.4	4.36	-0.51	1.20		1.20	
35	0.214	1.8	5.65	0.203	2.4	4.44	-0.57	1.18		1.18	
36	0.210	1.8	5.56	0.192	2.4	4.36	-0.57	1.16		1.16	
37	0.207	1.8	5.51	0.187	2.3	4.27	-0.51	1.13		1.13	
38	0.201	1.8	5.44	0.191	2.2	4.22	-0.47	1.13		1.13	
39	0.201	1.8	5.46	0.207	2.2	4.23	-0.47	1.15		1.15	
40	0.206	1.8	5.46	0.196	2.5	4.45	-0.69	1.14		1.14	
41	0.203	1.8	5.46	0.188	2.3	4.29	-0.54	1.20		1.20	
42	0.214	1.8	5.48	0.191	2.3	4.29	-0.51	1.18		1.18	
43	0.210	1.8	5.57	0.190	2.3	4.26	-0.46	1.15		1.15	
44	0.205	1.8	5.50	0.210	2.4	4.44	-0.62	1.06		1.06	
45	0.189	1.8	5.43	0.190	2.3	4.26	-0.53	0.94		0.94	
46	0.168	1.7	5.18	0.167	2.1	4.08	-0.46	0.82		0.82	
47	0.146	1.6	4.96	0.155	2.1	4.01	-0.49	0.82		0.82	
Average											
Weekday	0.175	1.6	5.22	0.160	2.0	3.99		0.98	#DIV/0!	0.98	
Weekend	0.186	1.7	5.28	0.178	2.2	4.18		1.05	#DIV/0!	1.05	
ADWF ⁽¹⁾	0.178	1.6	5.24	0.165	2.1	4.04		1.00	#DIV/0!	1.00	
% Error											
Weekday				-8.4%			0.75				
Weekend				-4.4%			0.69				
Note:											

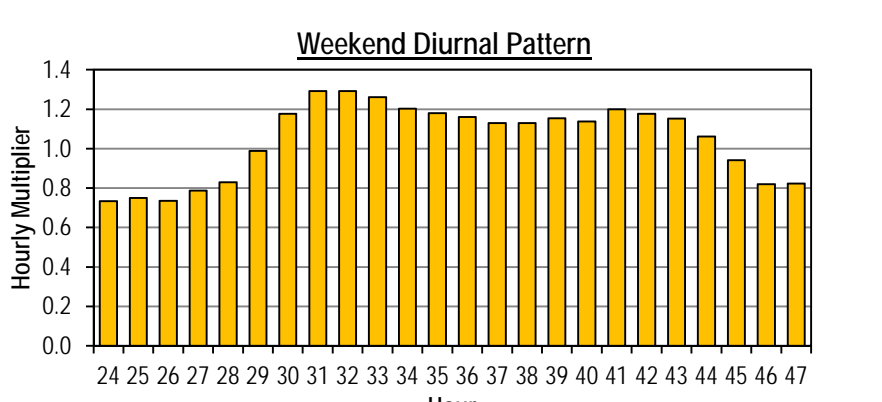
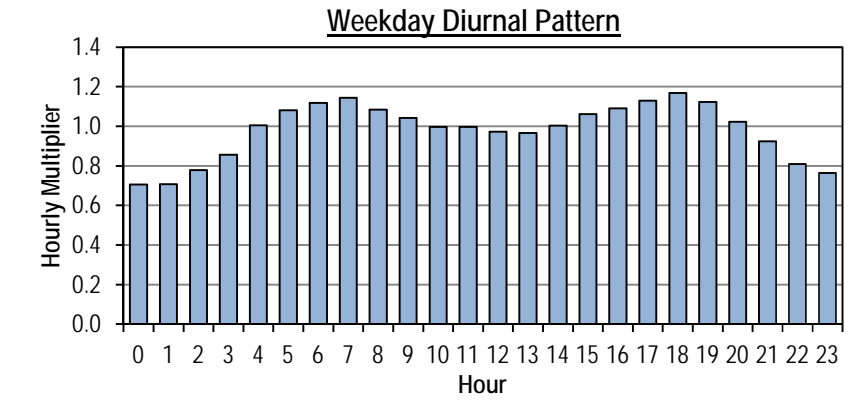
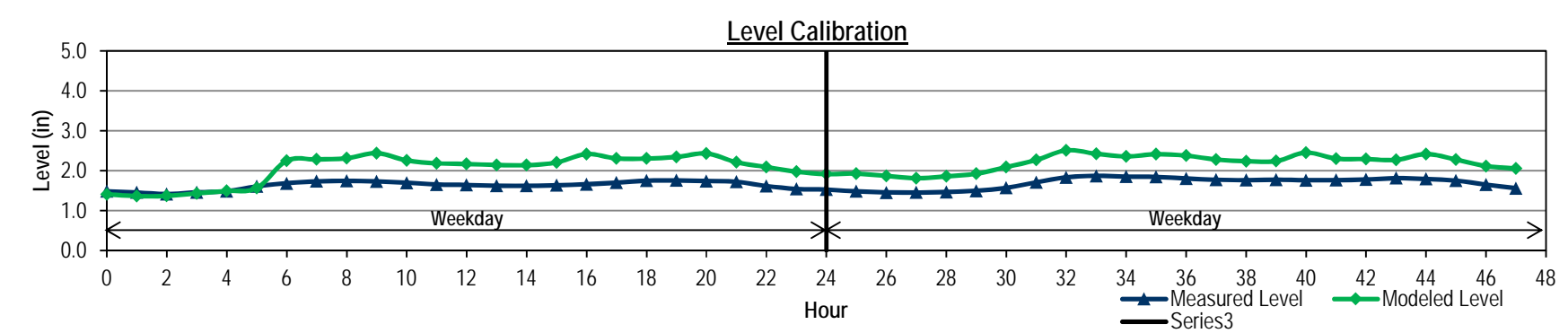
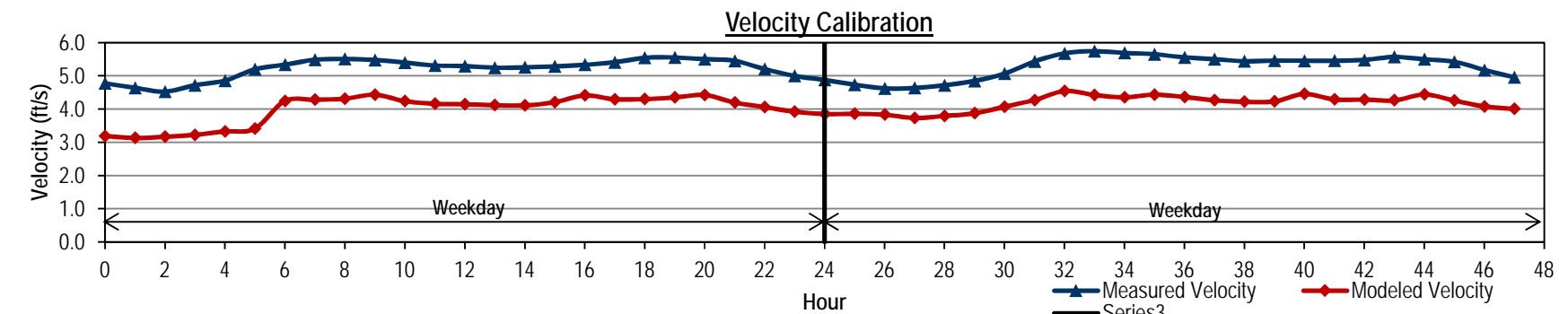
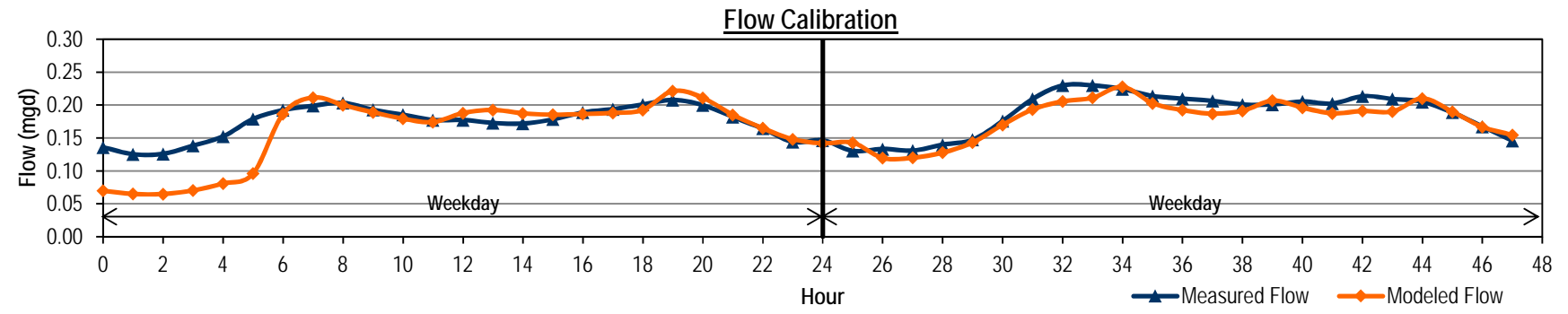



**City of Renton
Long-range Wastewater Management Plan
FLOW MONITORING SITE MH3216 DRY WEATHER FLOW CALIBRATION**



Hour	Measured Data			Modeled Data				Level Diff (in)	Diurnal		
	Flow (mgd)	Level (in)	Velocity (ft/s)	Flow (mgd)	Level (in)	Velocity (ft/s)	Initial Curve		Modified Curve	Calibrated Diurnal	
0	0.027	1.9	0.68	0.025	1.8	0.86	0.08	0.48		0.48	
1	0.024	1.8	0.65	0.023	1.7	0.85	0.13	0.46		0.46	
2	0.023	1.8	0.62	0.023	1.7	0.86	0.07	0.57		0.57	
3	0.028	1.8	0.64	0.029	1.9	0.92	-0.10	0.75		0.75	
4	0.037	2.0	0.73	0.039	2.3	0.99	-0.27	1.05		1.05	
5	0.051	2.3	0.86	0.052	2.6	1.07	-0.36	1.25		1.25	
6	0.061	2.5	0.96	0.061	2.9	1.11	-0.36	1.35		1.35	
7	0.066	2.6	1.02	0.065	3.0	1.12	-0.38	1.41		1.41	
8	0.069	2.7	1.04	0.066	3.0	1.12	-0.35	1.37		1.37	
9	0.067	2.7	1.06	0.065	3.0	1.11	-0.28	1.34		1.34	
10	0.065	2.7	1.03	0.063	2.9	1.10	-0.30	1.28		1.28	
11	0.062	2.6	1.02	0.061	2.9	1.10	-0.30	1.34		1.34	
12	0.065	2.6	1.02	0.064	3.0	1.11	-0.36	1.36		1.36	
13	0.066	2.7	1.03	0.063	2.9	1.10	-0.28	1.23		1.23	
14	0.060	2.6	1.01	0.058	2.8	1.08	-0.21	1.18		1.18	
15	0.058	2.6	0.99	0.055	2.7	1.06	-0.18	1.08		1.08	
16	0.053	2.5	0.94	0.052	2.7	1.05	-0.23	1.16		1.16	
17	0.057	2.5	0.95	0.056	2.8	1.07	-0.29	1.21		1.21	
18	0.059	2.6	0.98	0.055	2.7	1.07	-0.19	1.05		1.05	
19	0.051	2.5	0.95	0.049	2.6	1.03	-0.09	0.96		0.96	
20	0.047	2.4	0.91	0.044	2.4	1.00	-0.03	0.82		0.82	
21	0.040	2.3	0.85	0.038	2.2	0.96	0.03	0.69		0.69	
22	0.034	2.1	0.78	0.032	2.0	0.91	0.08	0.58		0.58	
23	0.028	2.0	0.72	0.027	1.9	0.88	0.09	0.55		0.55	
24	0.028	2.0	0.69	0.026	1.8	0.87	0.11	0.49		0.49	
25	0.024	1.9	0.66	0.025	1.8	0.87	0.07	0.48		0.48	
26	0.024	1.8	0.63	0.025	1.8	0.88	0.02	0.52		0.52	
27	0.026	1.8	0.64	0.028	1.9	0.91	-0.07	0.63		0.63	
28	0.031	1.9	0.67	0.035	2.1	0.96	-0.22	0.85		0.85	
29	0.042	2.1	0.76	0.047	2.5	1.04	-0.38	1.12		1.12	
30	0.055	2.4	0.89	0.062	2.9	1.12	-0.48	1.44		1.44	
31	0.070	2.6	0.98	0.074	3.2	1.17	-0.57	1.45		1.45	
32	0.071	2.8	1.06	0.073	3.2	1.16	-0.40	1.36		1.36	
33	0.066	2.8	1.06	0.068	3.1	1.13	-0.30	1.26		1.26	
34	0.062	2.6	0.98	0.063	2.9	1.10	-0.34	1.15		1.15	
35	0.056	2.6	0.98	0.060	2.9	1.09	-0.28	1.23		1.23	
36	0.060	2.6	0.96	0.061	2.9	1.09	-0.37	1.13		1.13	
37	0.055	2.6	0.98	0.056	2.8	1.06	-0.17	1.01		1.01	
38	0.049	2.5	0.91	0.051	2.6	1.03	-0.17	0.94		0.94	
39	0.046	2.3	0.87	0.049	2.6	1.03	-0.26	1.00		1.00	
40	0.049	2.3	0.87	0.053	2.7	1.05	-0.37	1.13		1.13	
41	0.055	2.5	0.93	0.056	2.8	1.07	-0.32	1.05		1.05	
42	0.051	2.5	0.93	0.053	2.7	1.05	-0.22	1.00		1.00	
43	0.049	2.4	0.91	0.050	2.6	1.03	-0.17	0.89		0.89	
44	0.044	2.3	0.86	0.044	2.4	1.00	-0.11	0.78		0.78	
45	0.038	2.3	0.83	0.039	2.3	0.97	-0.02	0.67		0.67	
46	0.033	2.1	0.77	0.033	2.1	0.93	0.02	0.58		0.58	
47	0.028	2.0	0.71	0.030	2.0	0.90	0.00	0.57		0.57	
Average											
Weekday	0.050	2.4	0.89	0.048	2.5	1.02		1.02	#DIV/0!	1.02	
Weekend	0.046	2.3	0.86	0.048	2.5	1.02		0.95	#DIV/0!	0.95	
ADWF ⁽¹⁾	0.049	2.3	0.88	0.048	2.5	1.02		1.00	#DIV/0!	1.00	
% Error											
Weekday				-2.4%			0.38				
Weekend				5.0%			0.57				
Note:											

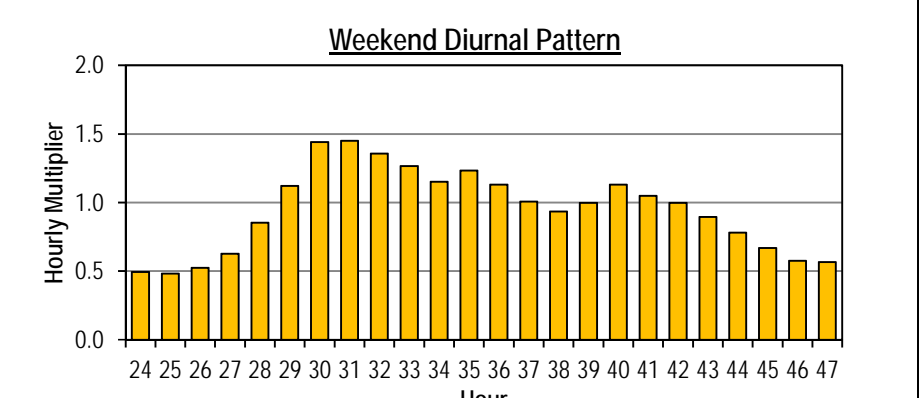
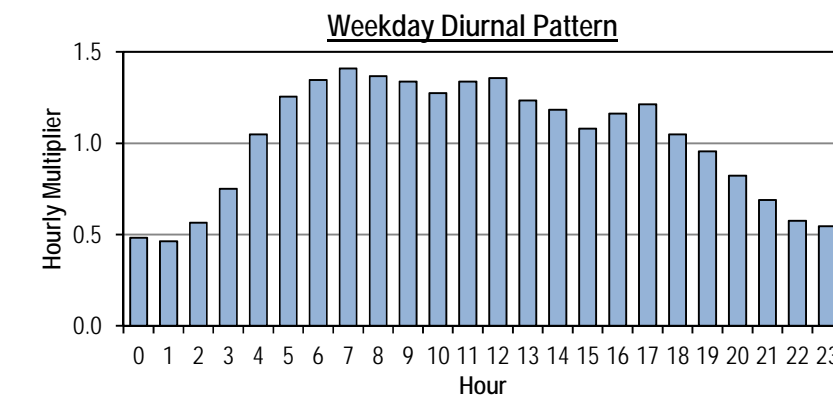
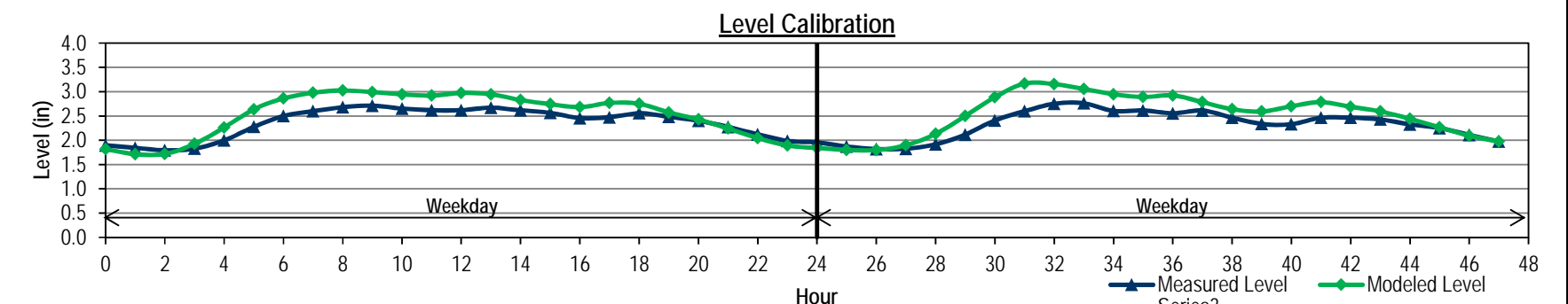
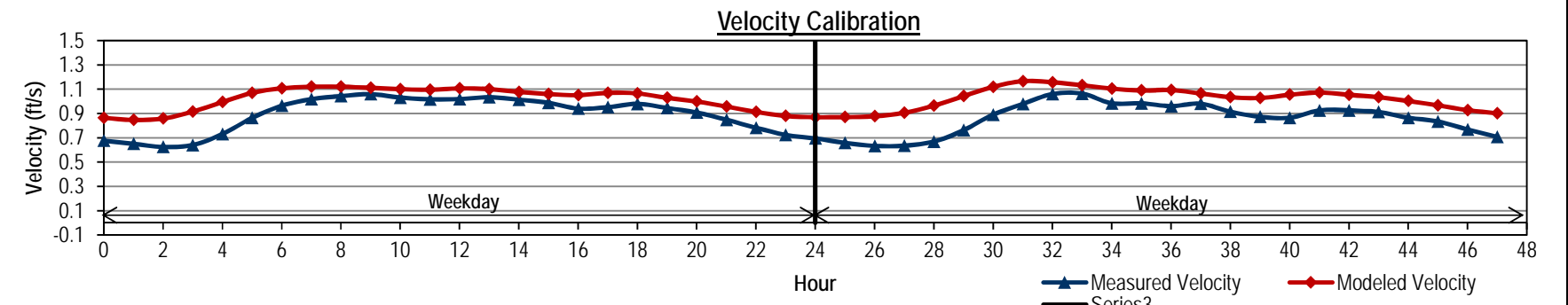
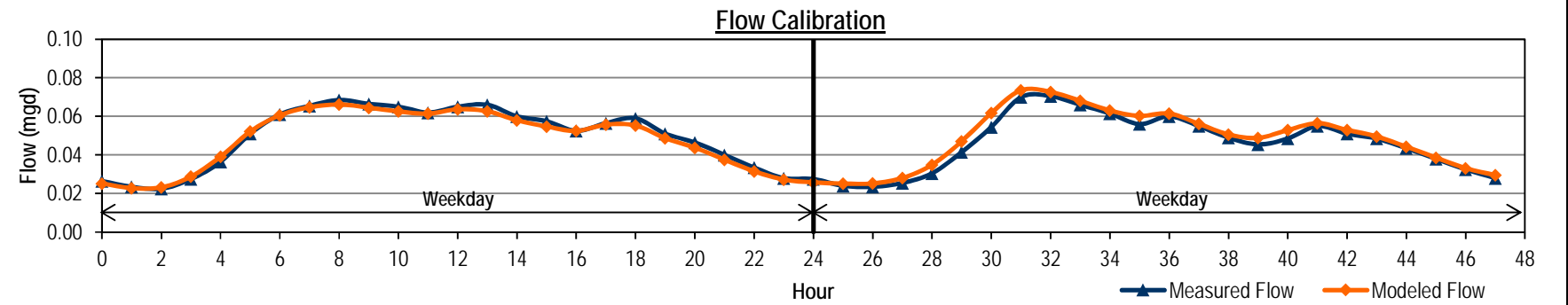



City of Renton
Long-range Wastewater Management Plan
FLOW MONITORING SITE MH3625 DRY WEATHER FLOW CALIBRATION



Hour	Measured Data			Modeled Data			Level Diff (in)	Diurnal		
	Flow (mgd)	Level (in)	Velocity (ft/s)	Flow (mgd)	Level (in)	Velocity (ft/s)		Initial Curve	Modified Curve	Calibrated Diurnal
0	0.347	4.2	2.30	0.339	3.6	2.35	0.66	0.57		0.57
1	0.310	3.9	2.19	0.313	3.4	2.28	0.57	0.55		0.55
2	0.303	3.8	2.13	0.336	3.5	2.33	0.35	0.60		0.60
3	0.331	3.9	2.15	0.312	3.6	2.36	0.32	0.72		0.72
4	0.395	4.2	2.26	0.365	3.7	2.43	0.41	1.01		1.01
5	0.557	4.8	2.47	0.481	4.3	2.62	0.51	1.16		1.16
6	0.637	5.4	2.69	0.491	4.6	2.71	0.87	1.15		1.15
7	0.633	5.6	2.75	0.646	5.0	2.85	0.58	1.11		1.11
8	0.607	5.5	2.70	0.561	5.1	2.90	0.41	1.06		1.06
9	0.581	5.4	2.68	0.589	4.9	2.85	0.48	1.03		1.03
10	0.565	5.2	2.64	0.540	5.3	2.94	-0.10	0.97		0.97
11	0.533	5.2	2.63	0.538	4.8	2.78	0.39	0.97		0.97
12	0.534	5.1	2.61	0.607	5.2	2.89	-0.08	0.97		0.97
13	0.533	5.0	2.59	0.570	4.8	2.79	0.29	0.97		0.97
14	0.532	5.0	2.59	0.613	5.2	2.90	-0.24	1.01		1.01
15	0.552	5.1	2.63	0.565	4.8	2.83	0.29	1.09		1.09
16	0.598	5.3	2.67	0.641	5.3	2.92	0.01	1.18		1.18
17	0.648	5.5	2.72	0.634	4.9	2.80	0.65	1.26		1.26
18	0.693	5.7	2.79	0.673	5.1	2.88	0.65	1.33		1.33
19	0.729	5.9	2.82	0.656	5.3	2.96	0.58	1.25		1.25
20	0.685	5.9	2.82	0.644	5.0	2.84	0.86	1.09		1.09
21	0.598	5.6	2.76	0.666	5.3	2.89	0.38	0.88		0.88
22	0.485	5.1	2.61	0.527	4.6	2.73	0.51	0.74		0.74
23	0.406	4.6	2.47	0.537	5.0	2.83	-0.39	0.63		0.63
24	0.402	4.5	2.45	0.354	3.5	2.35	0.97	0.64		0.64
25	0.350	4.3	2.36	0.361	4.0	2.54	0.22	0.58		0.58
26	0.320	4.0	2.25	0.435	4.2	2.54	-0.22	0.60		0.60
27	0.332	3.9	2.22	0.301	3.7	2.37	0.28	0.63		0.63
28	0.347	4.0	2.24	0.315	3.6	2.35	0.40	0.66		0.66
29	0.364	4.1	2.29	0.340	4.4	2.67	-0.27	0.90		0.90
30	0.496	4.4	2.43	0.444	4.4	2.70	0.00	1.16		1.16
31	0.638	5.1	2.68	0.525	4.8	2.78	0.36	1.39		1.39
32	0.764	6.0	2.83	0.667	5.3	2.96	0.72	1.44		1.44
33	0.787	6.3	2.90	0.751	6.0	3.13	0.39	1.45		1.45
34	0.794	6.4	2.88	0.675	5.2	2.92	1.20	1.36		1.36
35	0.745	6.2	2.85	0.677	5.3	2.94	0.86	1.30		1.30
36	0.711	6.0	2.83	0.634	5.0	2.83	1.06	1.25		1.25
37	0.683	5.9	2.83	0.619	4.9	2.81	0.93	1.20		1.20
38	0.659	5.8	2.77	0.603	5.7	3.06	0.05	1.19		1.19
39	0.653	5.7	2.76	0.596	4.9	2.84	0.81	1.21		1.21
40	0.662	5.7	2.77	0.670	5.1	2.90	0.54	1.26		1.26
41	0.689	5.8	2.79	0.612	4.7	2.76	1.07	1.31		1.31
42	0.716	5.8	2.79	0.621	4.9	2.83	0.89	1.29		1.29
43	0.709	6.0	2.82	0.613	4.8	2.80	1.19	1.25		1.25
44	0.683	5.9	2.78	0.628	4.7	2.77	1.17	1.11		1.11
45	0.608	5.6	2.76	0.513	5.2	2.94	0.41	0.95		0.95
46	0.521	5.2	2.66	0.450	4.3	2.65	0.96	0.84		0.84
47	0.460	4.7	2.50	0.400	3.9	2.54	0.80	0.73		0.73
Average										
Weekday	0.533	5.0	2.57	0.535	4.7	2.74		0.97	#DIV/0!	0.97
Weekend	0.587	5.3	2.64	0.534	4.7	2.75		1.07	#DIV/0!	1.07
ADWF ⁽¹⁾	0.548	5.1	2.59	0.535	4.7	2.74		1.00	#DIV/0!	1.00
% Error										
Weekday				0.4%			0.87			
Weekend				-9.1%			1.20			

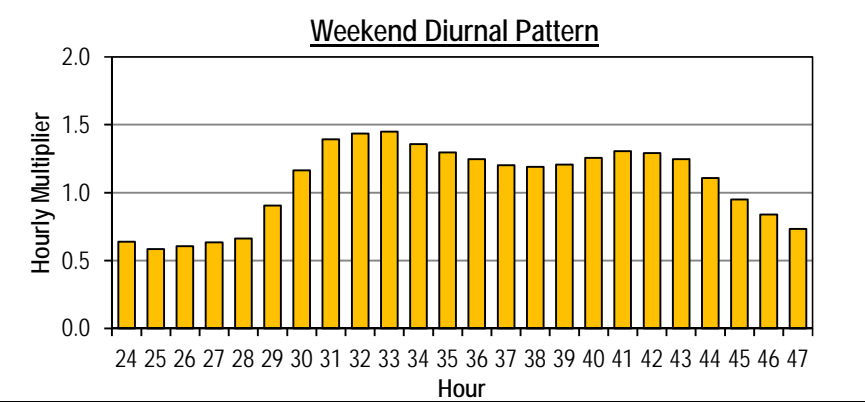
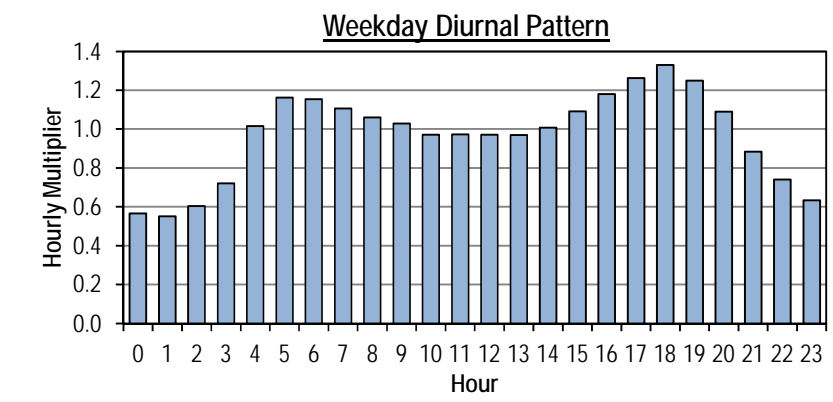
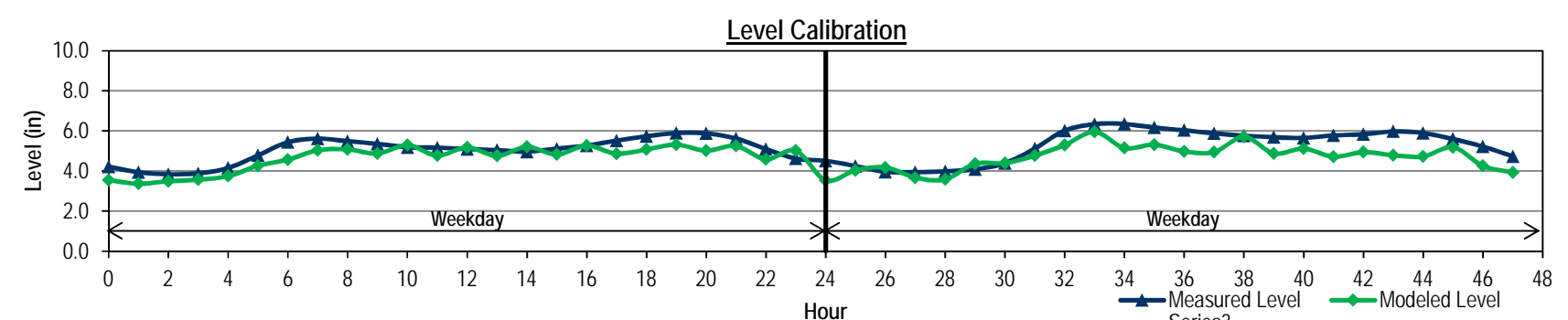
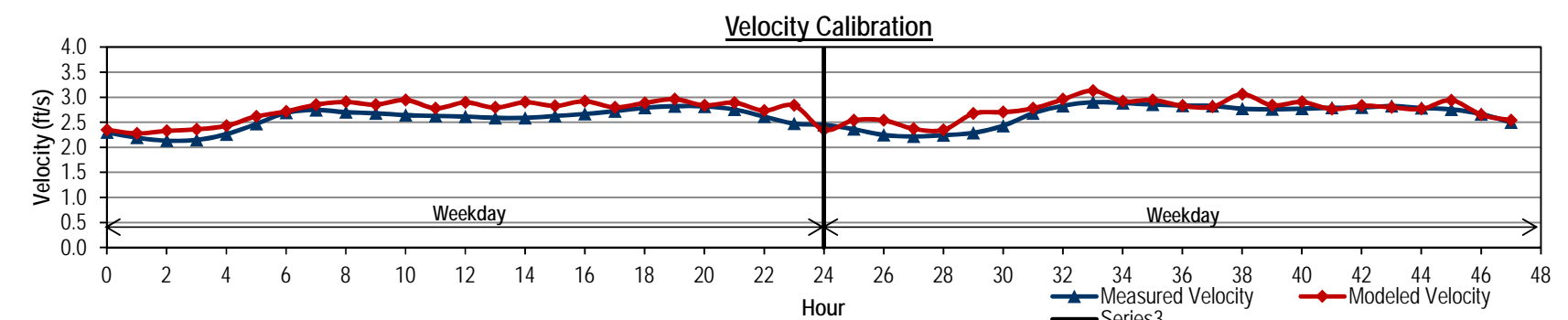
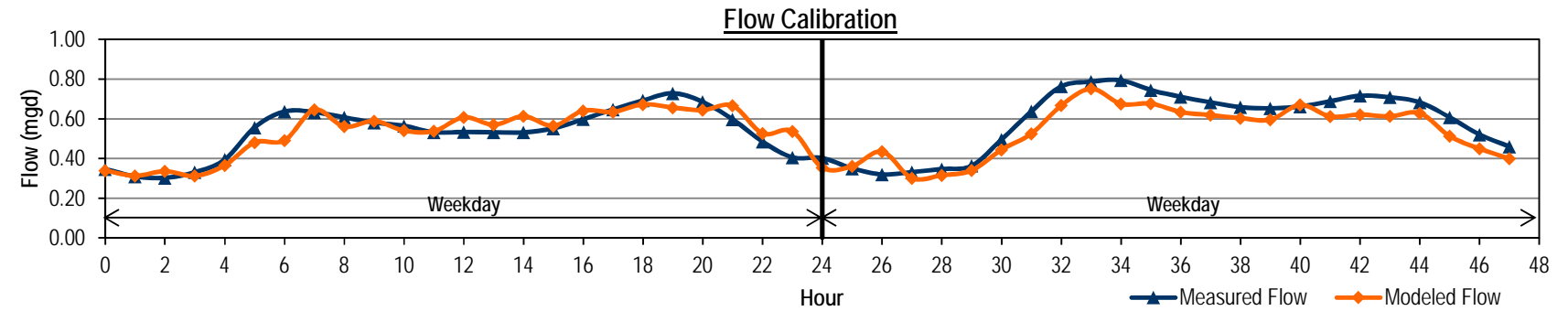



City of Renton
Long-range Wastewater Management Plan
FLOW MONITORING SITE MH4628 DRY WEATHER FLOW CALIBRATION



Hour	Measured Data			Modeled Data			Level Diff (in)	Diurnal		
	Flow (mgd)	Level (in)	Velocity (ft/s)	Flow (mgd)	Level (in)	Velocity (ft/s)		Initial Curve	Modified Curve	Calibrated Diurnal
0	0.125	1.7	4.06	0.127	1.4	3.45	0.28	0.73		0.73
1	0.120	1.7	3.93	0.122	1.4	3.42	0.27	0.72		0.72
2	0.119	1.7	3.83	0.121	1.4	3.41	0.27	0.75		0.75
3	0.124	1.7	3.84	0.128	1.4	3.48	0.23	0.90		0.90
4	0.149	1.7	3.91	0.151	1.5	3.67	0.14	1.04		1.04
5	0.172	1.8	4.24	0.174	1.6	3.81	0.11	1.11		1.11
6	0.184	1.8	4.45	0.185	1.7	3.87	0.12	1.10		1.10
7	0.183	1.8	4.34	0.184	1.7	3.86	0.16	1.07		1.07
8	0.177	1.8	4.41	0.179	1.7	3.83	0.16	1.04		1.04
9	0.173	1.8	4.36	0.175	1.6	3.80	0.17	1.01		1.01
10	0.167	1.8	4.38	0.169	1.6	3.77	0.17	0.99		0.99
11	0.163	1.8	4.29	0.165	1.6	3.74	0.17	0.97		0.97
12	0.161	1.8	4.26	0.163	1.6	3.73	0.17	0.95		0.95
13	0.158	1.8	4.18	0.160	1.6	3.71	0.17	0.97		0.97
14	0.160	1.7	4.24	0.163	1.6	3.73	0.15	1.03		1.03
15	0.171	1.8	4.28	0.173	1.6	3.80	0.12	1.08		1.08
16	0.178	1.8	4.58	0.181	1.7	3.85	0.12	1.13		1.13
17	0.187	1.8	4.56	0.190	1.7	3.90	0.11	1.18		1.18
18	0.195	1.9	4.51	0.197	1.7	3.94	0.12	1.18		1.18
19	0.195	1.9	4.54	0.197	1.7	3.94	0.13	1.15		1.15
20	0.190	1.9	4.47	0.191	1.7	3.90	0.16	1.04		1.04
21	0.173	1.8	4.42	0.174	1.6	3.78	0.21	0.92		0.92
22	0.152	1.8	4.27	0.154	1.5	3.65	0.23	0.83		0.83
23	0.137	1.7	4.12	0.139	1.5	3.54	0.25	0.75		0.75
24	0.128	1.7	4.09	0.127	1.4	3.45	0.31	0.74		0.74
25	0.122	1.7	3.83	0.119	1.4	3.39	0.31	0.72		0.72
26	0.120	1.7	3.81	0.116	1.3	3.36	0.32	0.72		0.72
27	0.119	1.7	3.70	0.115	1.3	3.37	0.32	0.75		0.75
28	0.125	1.7	3.56	0.121	1.4	3.42	0.30	0.81		0.81
29	0.134	1.7	3.85	0.131	1.4	3.51	0.25	0.96		0.96
30	0.159	1.7	3.95	0.155	1.6	3.69	0.16	1.16		1.16
31	0.191	1.8	4.28	0.184	1.7	3.88	0.12	1.27		1.27
32	0.210	1.9	4.49	0.201	1.8	3.97	0.14	1.28		1.28
33	0.212	1.9	4.60	0.204	1.8	3.98	0.17	1.26		1.26
34	0.209	1.9	4.54	0.200	1.8	3.96	0.18	1.21		1.21
35	0.201	1.9	4.54	0.193	1.7	3.91	0.20	1.17		1.17
36	0.193	1.9	4.47	0.186	1.7	3.87	0.20	1.16		1.16
37	0.192	1.9	4.57	0.185	1.7	3.87	0.18	1.17		1.17
38	0.193	1.9	4.42	0.186	1.7	3.87	0.19	1.15		1.15
39	0.190	1.9	4.34	0.183	1.7	3.86	0.20	1.15		1.15
40	0.190	1.9	4.36	0.183	1.7	3.85	0.19	1.14		1.14
41	0.188	1.9	4.43	0.182	1.7	3.85	0.18	1.18		1.18
42	0.195	1.9	4.46	0.187	1.7	3.88	0.17	1.18		1.18
43	0.195	1.9	4.46	0.187	1.7	3.88	0.19	1.14		1.14
44	0.188	1.9	4.42	0.179	1.7	3.82	0.21	1.02		1.02
45	0.168	1.8	4.37	0.162	1.6	3.71	0.26	0.92		0.92
46	0.152	1.8	4.24	0.146	1.5	3.60	0.26	0.84		0.84
47	0.139	1.7	4.12	0.134	1.4	3.51	0.29	0.77		0.77
Average										
Weekday	0.163	1.8	4.27	0.165	1.6	3.73		0.99	#DIV/0!	0.99
Weekend	0.171	1.8	4.24	0.165	1.6	3.73		1.04	#DIV/0!	1.04
ADWF ⁽¹⁾	0.165	1.8	4.26	0.165	1.6	3.73		1.00	#DIV/0!	1.00
% Error										
Weekday				1.4%			0.28			
Weekend				-3.4%			0.32			

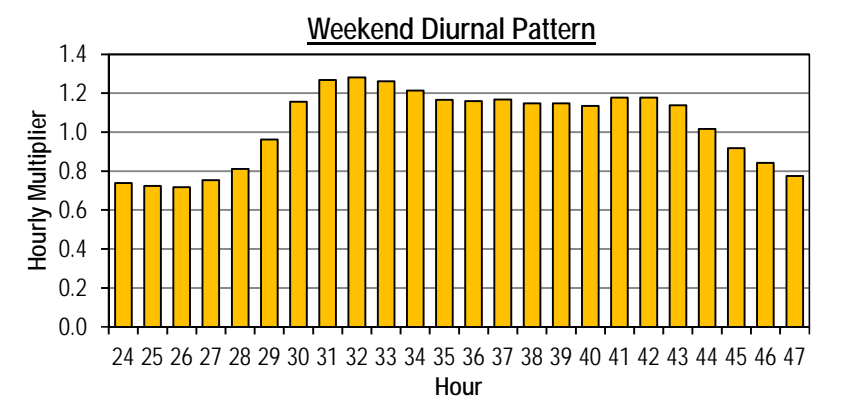
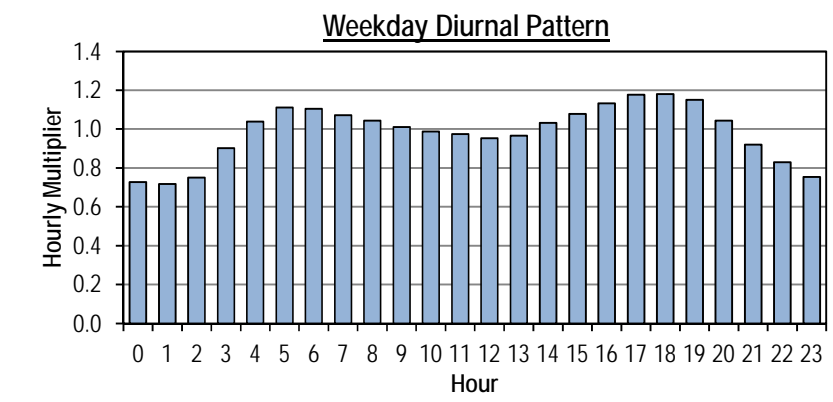
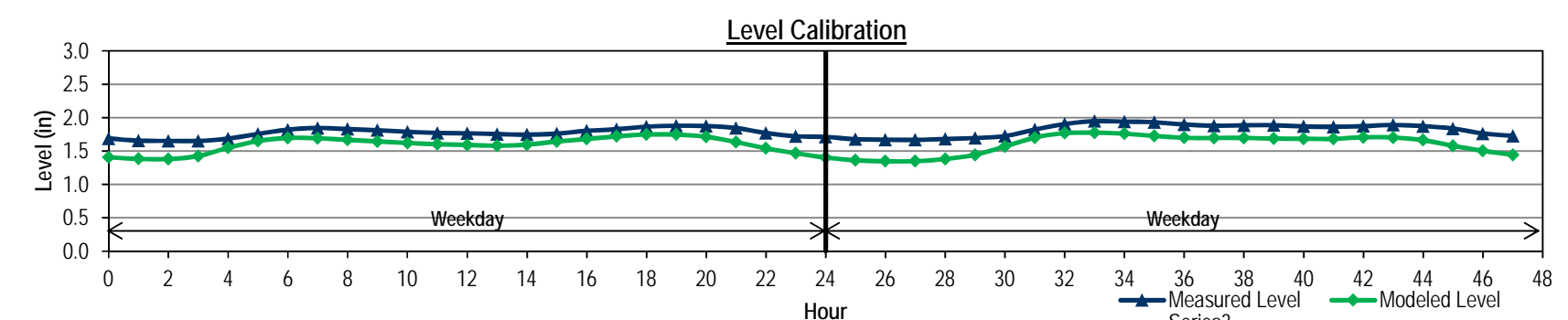
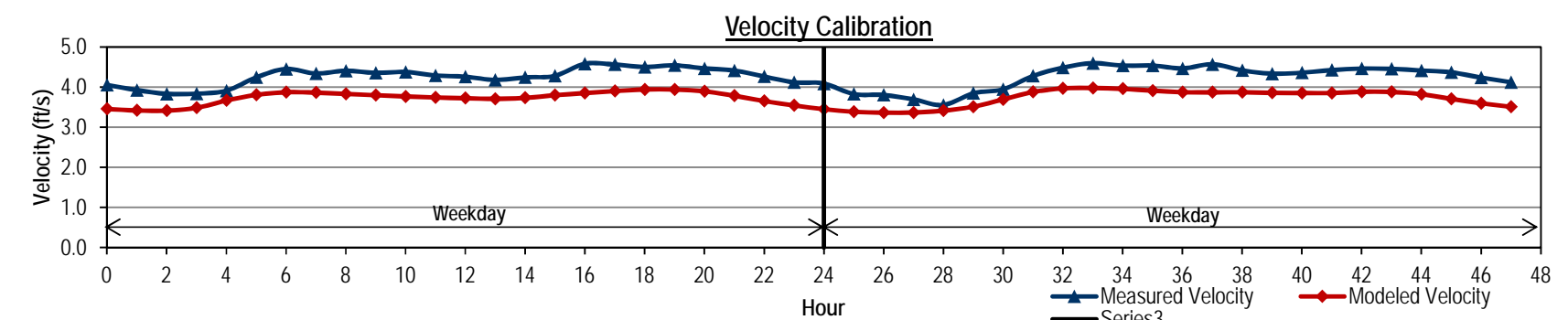
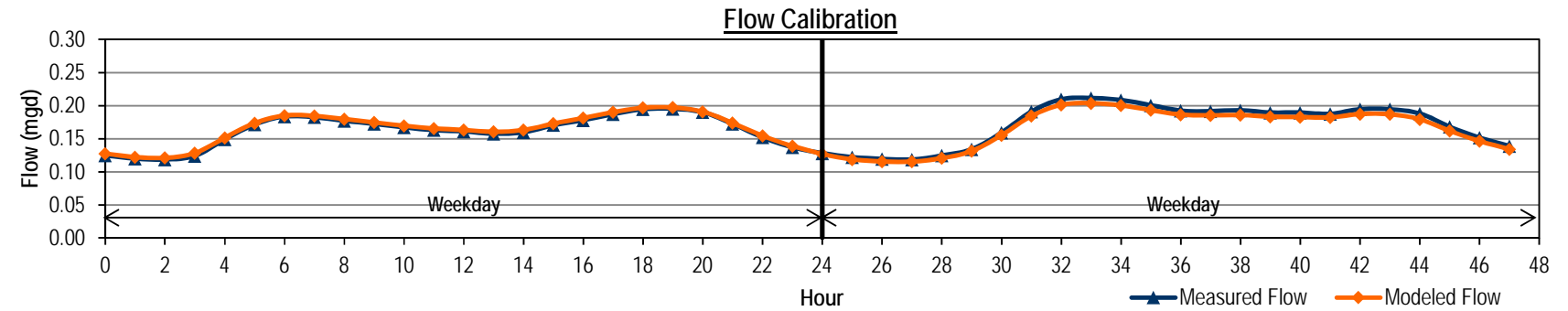



City of Renton
Long-range Wastewater Management Plan
FLOW MONITORING SITE MH4646 DRY WEATHER FLOW CALIBRATION



Hour	Measured Data			Modeled Data			Level Diff (in)	Diurnal		
	Flow (mgd)	Level (in)	Velocity (ft/s)	Flow (mgd)	Level (in)	Velocity (ft/s)		Initial Curve	Modified Curve	Calibrated Diurnal
0	0.177	1.2	8.38	0.177	4.1	7.60	-2.84	0.83		0.83
1	0.172	1.2	8.09	0.172	4.0	7.55	-2.73	0.84		0.84
2	0.172	1.2	7.99	0.173	3.9	7.57	-2.69	0.86		0.86
3	0.178	1.2	8.10	0.180	3.9	7.66	-2.69	0.93		0.93
4	0.192	1.2	8.43	0.194	4.0	7.85	-2.78	1.03		1.03
5	0.213	1.3	8.91	0.212	4.3	8.04	-3.00	1.06		1.06
6	0.217	1.3	9.30	0.216	4.4	8.08	-3.13	1.05		1.05
7	0.215	1.3	9.27	0.215	4.9	8.06	-3.57	1.04		1.04
8	0.213	1.3	9.25	0.213	4.8	8.04	-3.52	1.03		1.03
9	0.211	1.3	9.27	0.211	4.9	8.02	-3.62	1.02		1.02
10	0.209	1.3	9.21	0.209	4.7	8.00	-3.46	1.02		1.02
11	0.210	1.3	9.17	0.209	4.7	8.00	-3.44	1.01		1.01
12	0.208	1.3	9.14	0.208	4.6	7.98	-3.32	1.01		1.01
13	0.208	1.3	9.13	0.208	4.6	7.98	-3.36	1.00		1.00
14	0.206	1.3	9.10	0.207	4.6	7.97	-3.27	1.02		1.02
15	0.210	1.3	9.13	0.211	4.6	8.03	-3.35	1.06		1.06
16	0.219	1.3	9.29	0.219	4.6	8.12	-3.34	1.10		1.10
17	0.226	1.3	9.45	0.226	4.8	8.19	-3.44	1.11		1.11
18	0.229	1.3	9.56	0.228	4.8	8.21	-3.52	1.11		1.11
19	0.228	1.3	9.57	0.227	4.9	8.19	-3.59	1.09		1.09
20	0.223	1.3	9.54	0.221	5.0	8.13	-3.72	1.03		1.03
21	0.213	1.3	9.38	0.211	4.8	8.01	-3.49	0.97		0.97
22	0.200	1.3	9.08	0.199	4.6	7.87	-3.33	0.91		0.91
23	0.188	1.3	8.75	0.187	4.4	7.73	-3.09	0.86		0.86
24	0.177	1.2	8.36	0.178	4.2	7.61	-2.97	0.85		0.85
25	0.175	1.2	8.13	0.174	4.0	7.57	-2.79	0.82		0.82
26	0.170	1.2	8.03	0.171	3.9	7.53	-2.66	0.84		0.84
27	0.173	1.2	7.93	0.172	3.9	7.55	-2.65	0.83		0.83
28	0.172	1.2	7.94	0.173	3.9	7.57	-2.66	0.88		0.88
29	0.181	1.2	8.10	0.183	4.0	7.71	-2.81	0.97		0.97
30	0.199	1.3	8.60	0.202	4.3	7.94	-3.01	1.08		1.08
31	0.222	1.3	9.22	0.223	4.5	8.17	-3.17	1.15		1.15
32	0.236	1.3	9.62	0.237	4.9	8.31	-3.53	1.19		1.19
33	0.244	1.4	9.73	0.243	4.9	8.37	-3.49	1.18		1.18
34	0.243	1.4	9.69	0.240	5.0	8.32	-3.59	1.11		1.11
35	0.228	1.4	9.61	0.227	5.1	8.19	-3.73	1.08		1.08
36	0.221	1.3	9.48	0.222	4.9	8.14	-3.62	1.08		1.08
37	0.222	1.3	9.42	0.220	5.0	8.11	-3.70	1.03		1.03
38	0.211	1.3	9.36	0.212	4.9	8.02	-3.63	1.03		1.03
39	0.211	1.3	9.25	0.211	4.9	8.02	-3.61	1.02		1.02
40	0.210	1.3	9.31	0.211	4.9	8.03	-3.58	1.05		1.05
41	0.216	1.3	9.32	0.217	4.9	8.09	-3.60	1.08		1.08
42	0.222	1.3	9.50	0.219	5.0	8.11	-3.73	1.03		1.03
43	0.212	1.3	9.39	0.213	5.0	8.03	-3.66	1.03		1.03
44	0.212	1.3	9.38	0.210	5.0	8.00	-3.74	0.98		0.98
45	0.202	1.3	9.23	0.201	4.8	7.90	-3.53	0.94		0.94
46	0.194	1.3	8.96	0.192	4.6	7.79	-3.35	0.89		0.89
47	0.182	1.2	8.64	0.182	4.4	7.67	-3.13	0.86		0.86
Average										
Weekday	0.205	1.3	9.02	0.205	4.5	7.95		1.00	#DIV/0!	1.00
Weekend	0.205	1.3	9.01	0.205	4.6	7.95		1.00	#DIV/0!	1.00
ADWF ⁽¹⁾	0.205	1.3	9.02	0.205	4.6	7.95		1.00	#DIV/0!	1.00
% Error										
Weekday				0.0%			3.72			
Weekend				0.0%			3.74			

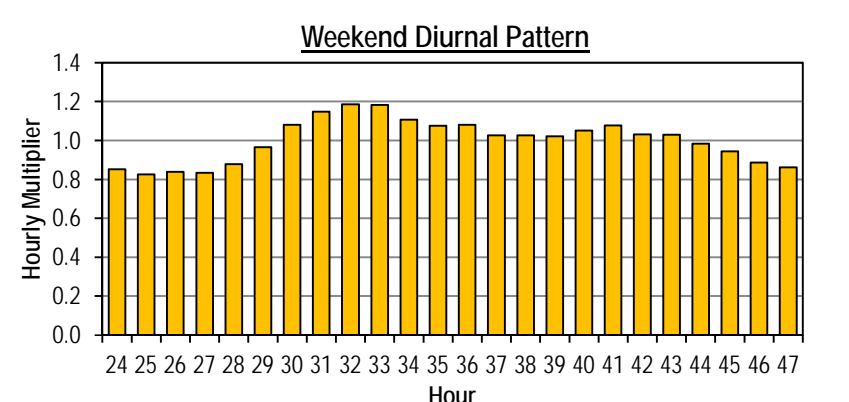
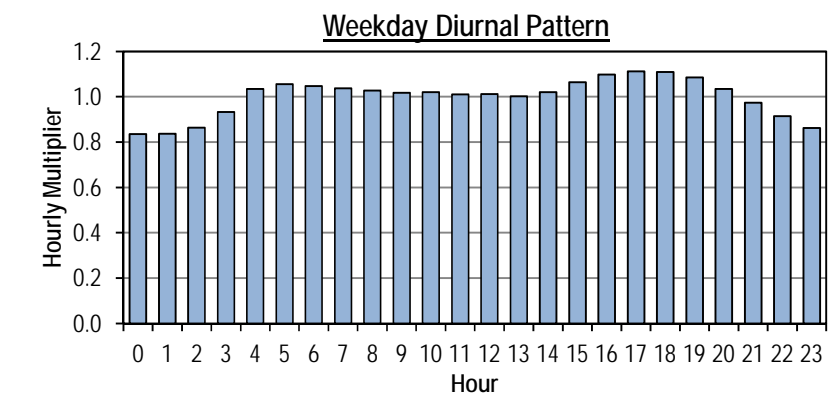
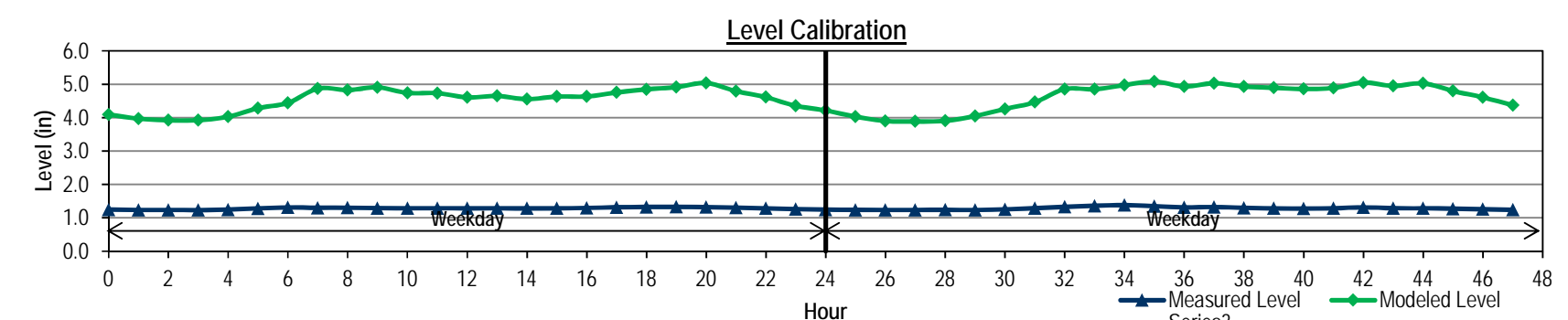
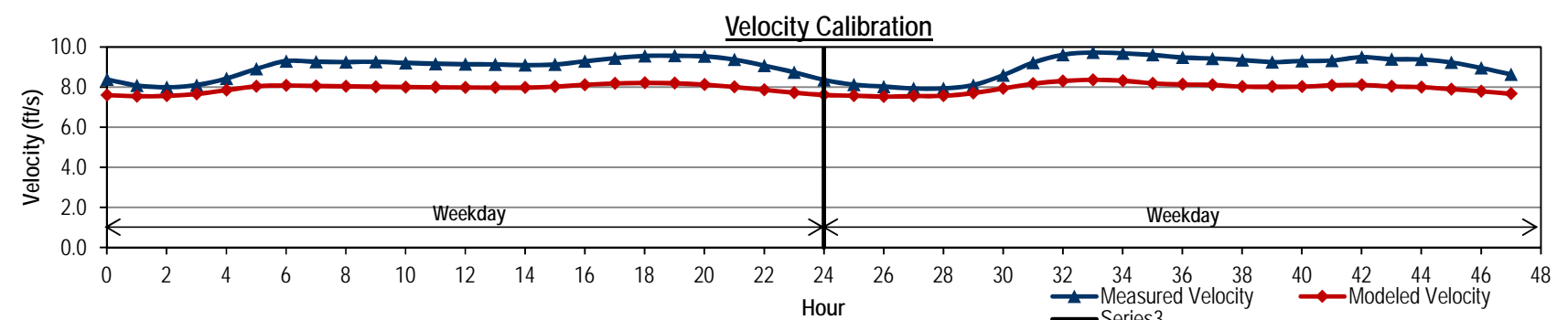
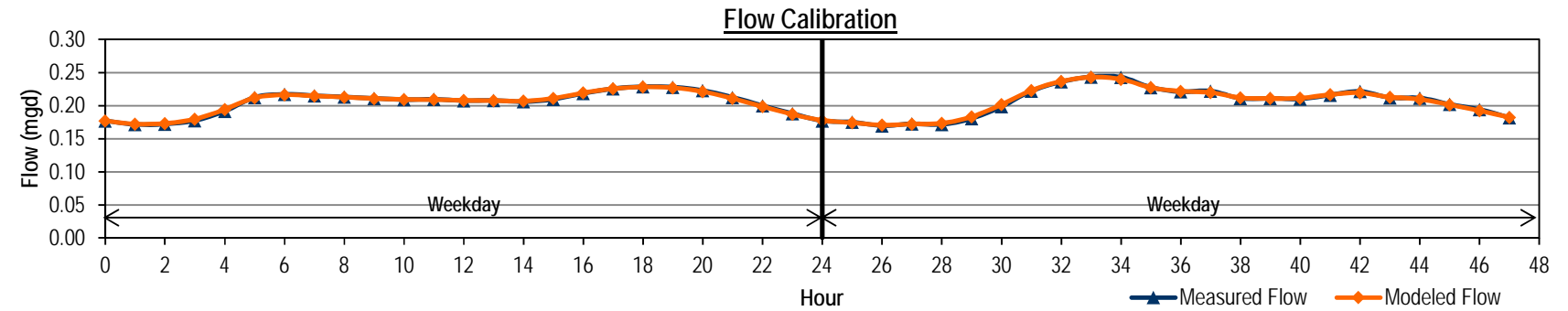



**City of Renton
Long-range Wastewater Management Plan
FLOW MONITORING SITE MH5302 DRY WEATHER FLOW CALIBRATION**



Hour	Measured Data			Modeled Data				Level Diff (in)	Diurnal		
	Flow (mgd)	Level (in)	Velocity (ft/s)	Flow (mgd)	Level (in)	Velocity (ft/s)	Initial Curve		Modified Curve	Calibrated Diurnal	
0	1.424	7.8	3.12	1.388	6.0	3.77	1.82	0.72		0.72	
1	1.213	7.3	2.91	1.089	5.8	2.97	1.50	0.65		0.65	
2	1.097	6.9	2.73	0.886	5.8	2.75	1.09	0.64		0.64	
3	1.082	6.7	2.67	0.747	5.4	2.73	1.36	0.72		0.72	
4	1.220	6.9	2.71	0.770	5.5	2.62	1.39	0.89		0.89	
5	1.503	7.4	2.94	0.891	5.7	2.88	1.76	1.04		1.04	
6	1.751	8.0	3.18	1.129	6.3	3.41	1.73	1.11		1.11	
7	1.874	8.5	3.34	1.424	6.8	3.97	1.72	1.10		1.10	
8	1.851	8.6	3.36	1.832	6.7	4.10	1.90	1.09		1.09	
9	1.845	8.5	3.35	1.908	7.0	4.13	1.55	1.07		1.07	
10	1.810	8.5	3.33	1.806	6.7	4.13	1.72	1.06		1.06	
11	1.799	8.4	3.33	1.897	6.8	4.06	1.66	1.06		1.06	
12	1.795	8.4	3.32	1.790	6.8	4.07	1.62	1.04		1.04	
13	1.765	8.3	3.31	1.681	6.5	4.00	1.81	1.04		1.04	
14	1.752	8.3	3.30	1.644	6.4	3.95	1.92	1.05		1.05	
15	1.769	8.3	3.30	1.687	6.4	3.99	1.87	1.07		1.07	
16	1.805	8.3	3.32	1.572	6.4	3.91	1.96	1.12		1.12	
17	1.887	8.5	3.37	1.580	6.3	4.00	2.16	1.16		1.16	
18	1.960	8.6	3.42	1.808	6.7	4.09	1.89	1.19		1.19	
19	2.009	8.8	3.47	1.813	6.7	4.14	2.05	1.17		1.17	
20	1.983	8.8	3.48	1.956	7.0	4.19	1.75	1.14		1.14	
21	1.923	8.7	3.45	1.954	7.0	4.21	1.69	1.06		1.06	
22	1.793	8.5	3.40	1.974	6.9	4.10	1.59	0.97		0.97	
23	1.636	8.2	3.28	1.791	6.6	3.95	1.57	0.84		0.84	
24	1.430	7.8	3.13	1.377	5.9	3.73	1.86	0.72		0.72	
25	1.209	7.3	2.90	1.121	6.0	2.99	1.35	0.63		0.63	
26	1.060	6.8	2.72	0.864	5.8	2.79	1.07	0.60		0.60	
27	1.007	6.5	2.63	0.716	5.4	2.59	1.14	0.59		0.59	
28	0.990	6.5	2.61	0.714	5.3	2.50	1.21	0.61		0.61	
29	1.035	6.5	2.61	0.710	5.2	2.52	1.28	0.75		0.75	
30	1.260	6.8	2.73	0.701	5.3	2.67	1.52	0.94		0.94	
31	1.596	7.6	3.03	0.909	5.7	2.97	1.85	1.14		1.14	
32	1.918	8.3	3.28	1.194	6.5	3.58	1.87	1.22		1.22	
33	2.053	8.9	3.43	1.733	6.4	4.19	2.43	1.22		1.22	
34	2.069	9.0	3.50	2.112	7.3	4.32	1.73	1.22		1.22	
35	2.054	8.9	3.51	2.244	7.6	4.33	1.38	1.19		1.19	
36	2.016	8.9	3.51	2.272	7.4	4.30	1.48	1.18		1.18	
37	1.986	8.8	3.48	2.108	7.3	4.25	1.49	1.15		1.15	
38	1.938	8.7	3.46	2.109	7.1	4.19	1.53	1.14		1.14	
39	1.931	8.6	3.44	1.882	6.9	4.13	1.72	1.14		1.14	
40	1.925	8.6	3.44	1.882	6.7	4.11	1.85	1.15		1.15	
41	1.936	8.6	3.45	1.752	6.7	4.14	1.94	1.16		1.16	
42	1.968	8.6	3.45	1.870	6.7	4.15	1.91	1.18		1.18	
43	1.986	8.8	3.49	1.768	6.7	4.15	2.07	1.16		1.16	
44	1.956	8.7	3.48	1.913	6.9	4.15	1.82	1.11		1.11	
45	1.884	8.6	3.44	1.817	6.8	4.10	1.84	1.03		1.03	
46	1.745	8.4	3.38	1.764	6.6	4.05	1.75	0.95		0.95	
47	1.607	8.0	3.27	1.583	6.3	3.88	1.73	0.85		0.85	
Average											
Weekday	1.689	8.1	3.22	1.542	6.4	3.76		1.00	#DIV/0!	1.00	
Weekend	1.690	8.1	3.22	1.546	6.4	3.70		1.00	#DIV/0!	1.00	
ADWF ⁽¹⁾	1.689	8.1	3.22	1.544	6.4	3.74		1.00	#DIV/0!	1.00	
% Error											
Weekday				-8.7%			2.16				
Weekend				-8.5%			2.43				
Note:											

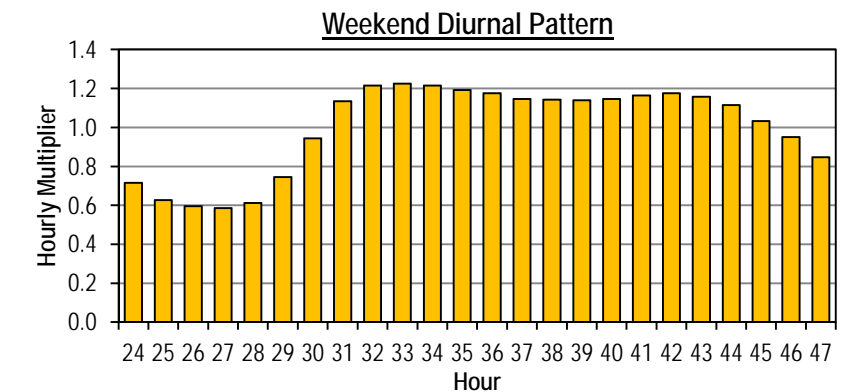
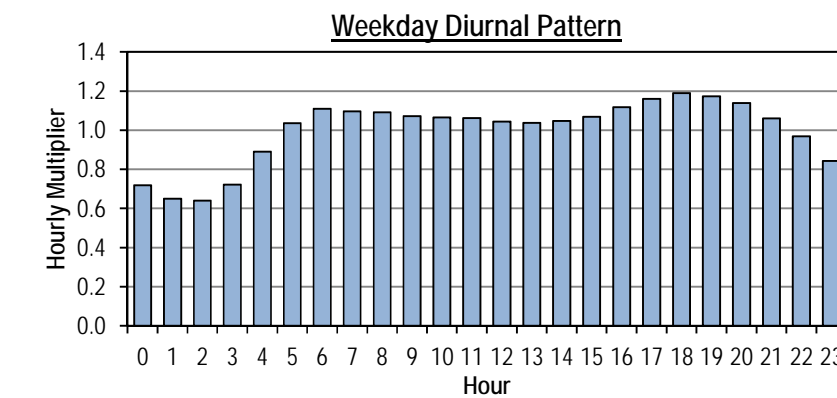
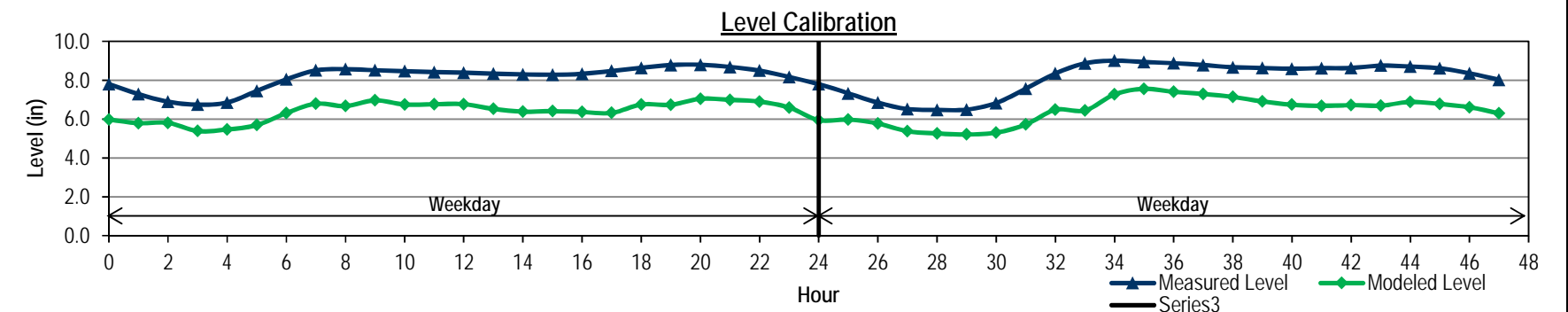
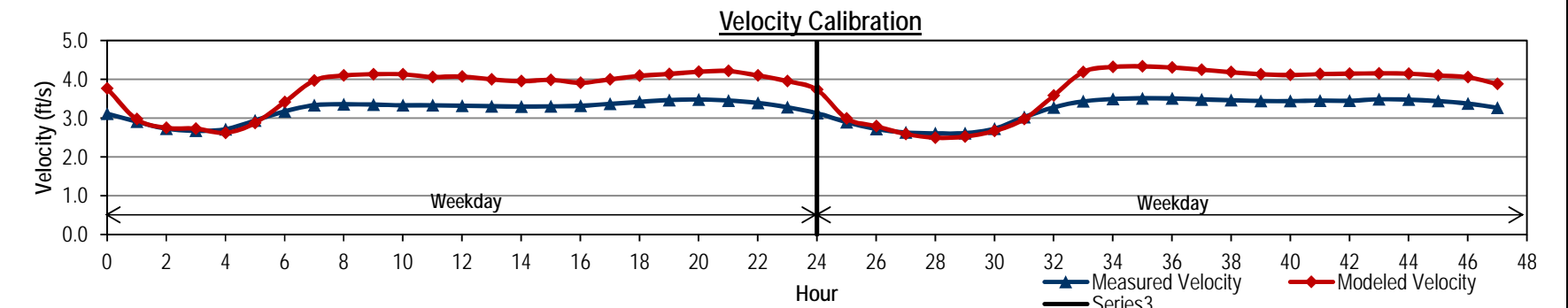
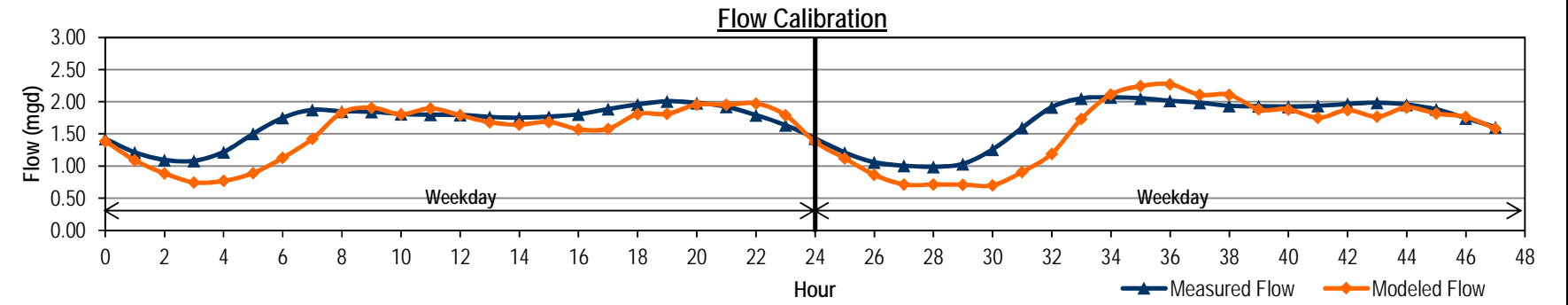



City of Renton
Long-range Wastewater Management Plan
FLOW MONITORING SITE MH5505 DRY WEATHER FLOW CALIBRATION



Hour	Measured Data			Modeled Data			Level Diff (in)	Diurnal		
	Flow (mgd)	Level (in)	Velocity (ft/s)	Flow (mgd)	Level (in)	Velocity (ft/s)		Initial Curve	Modified Curve	Calibrated Diurnal
0	0.180	1.5	5.57	0.191	1.9	3.81	-0.37	0.80		0.80
1	0.169	1.5	5.42	0.172	1.8	3.75	-0.36	0.80		0.80
2	0.170	1.4	5.38	0.165	1.9	3.88	-0.48	0.83		0.83
3	0.175	1.4	5.43	0.171	1.9	3.85	-0.46	0.91		0.91
4	0.192	1.5	5.53	0.198	1.9	3.87	-0.44	1.01		1.01
5	0.214	1.6	5.76	0.210	2.1	4.09	-0.53	1.07		1.07
6	0.227	1.6	6.00	0.225	2.1	4.08	-0.49	1.10		1.10
7	0.232	1.6	6.09	0.232	2.2	4.21	-0.56	1.08		1.08
8	0.229	1.6	6.11	0.232	2.1	4.08	-0.45	1.05		1.05
9	0.223	1.6	6.01	0.223	2.2	4.15	-0.52	1.04		1.04
10	0.220	1.6	5.95	0.223	2.1	4.03	-0.44	1.02		1.02
11	0.216	1.6	5.90	0.218	2.1	4.10	-0.50	1.02		1.02
12	0.216	1.6	5.90	0.216	2.0	4.01	-0.43	1.00		1.00
13	0.213	1.6	5.87	0.216	2.1	4.08	-0.49	1.01		1.01
14	0.213	1.6	5.81	0.210	2.0	3.99	-0.42	1.01		1.01
15	0.214	1.6	5.84	0.220	2.1	4.09	-0.50	1.03		1.03
16	0.219	1.6	5.88	0.213	2.0	4.02	-0.44	1.07		1.07
17	0.226	1.6	5.98	0.231	2.2	4.14	-0.53	1.10		1.10
18	0.234	1.6	6.09	0.228	2.2	4.14	-0.51	1.12		1.12
19	0.238	1.7	6.18	0.241	2.2	4.15	-0.50	1.11		1.11
20	0.234	1.7	6.15	0.235	2.2	4.22	-0.55	1.04		1.04
21	0.220	1.6	6.04	0.223	2.1	4.03	-0.41	0.96		0.96
22	0.204	1.6	5.83	0.206	2.1	4.07	-0.50	0.91		0.91
23	0.194	1.5	5.70	0.201	1.9	3.89	-0.39	0.85		0.85
24	0.176	1.5	5.56	0.179	1.9	3.86	-0.43	0.81		0.81
25	0.172	1.5	5.50	0.167	1.9	3.87	-0.47	0.77		0.77
26	0.163	1.4	5.44	0.169	1.8	3.73	-0.40	0.74		0.74
27	0.158	1.4	5.34	0.167	1.8	3.66	-0.36	0.80		0.80
28	0.169	1.4	5.40	0.171	1.8	3.70	-0.38	0.83		0.83
29	0.175	1.4	5.48	0.173	1.9	3.83	-0.45	0.95		0.95
30	0.201	1.5	5.65	0.189	2.0	4.01	-0.55	1.08		1.08
31	0.229	1.6	5.95	0.230	2.1	4.05	-0.48	1.15		1.15
32	0.244	1.6	6.27	0.234	2.2	4.22	-0.57	1.16		1.16
33	0.246	1.7	6.28	0.250	2.2	4.24	-0.55	1.18		1.18
34	0.249	1.7	6.33	0.247	2.2	4.17	-0.49	1.13		1.13
35	0.240	1.7	6.25	0.237	2.2	4.21	-0.53	1.12		1.12
36	0.236	1.7	6.18	0.243	2.2	4.17	-0.51	1.11		1.11
37	0.235	1.7	6.12	0.228	2.1	4.12	-0.47	1.07		1.07
38	0.227	1.6	6.05	0.234	2.2	4.18	-0.53	1.05		1.05
39	0.222	1.6	6.02	0.216	2.1	4.04	-0.43	1.06		1.06
40	0.224	1.6	5.95	0.229	2.2	4.16	-0.55	1.09		1.09
41	0.231	1.6	6.08	0.223	2.1	4.08	-0.46	1.11		1.11
42	0.234	1.7	6.13	0.239	2.2	4.18	-0.54	1.13		1.13
43	0.239	1.7	6.17	0.232	2.2	4.18	-0.51	1.09		1.09
44	0.230	1.7	6.11	0.232	2.1	4.10	-0.46	1.03		1.03
45	0.218	1.6	5.99	0.217	2.1	4.13	-0.50	0.94		0.94
46	0.199	1.6	5.79	0.206	2.0	3.93	-0.39	0.89		0.89
47	0.189	1.5	5.66	0.183	1.9	3.89	-0.40	0.83		0.83
Average										
Weekday	0.211	1.6	5.85	0.212	2.1	4.03		1.00	#DIV/0!	1.00
Weekend	0.212	1.6	5.90	0.212	2.1	4.03		1.00	#DIV/0!	1.00
ADWF ⁽¹⁾	0.211	1.6	5.87	0.212	2.1	4.03		1.00	#DIV/0!	1.00
% Error										
Weekday				0.6%			0.56			
Weekend				-0.1%			0.57			
Note:										

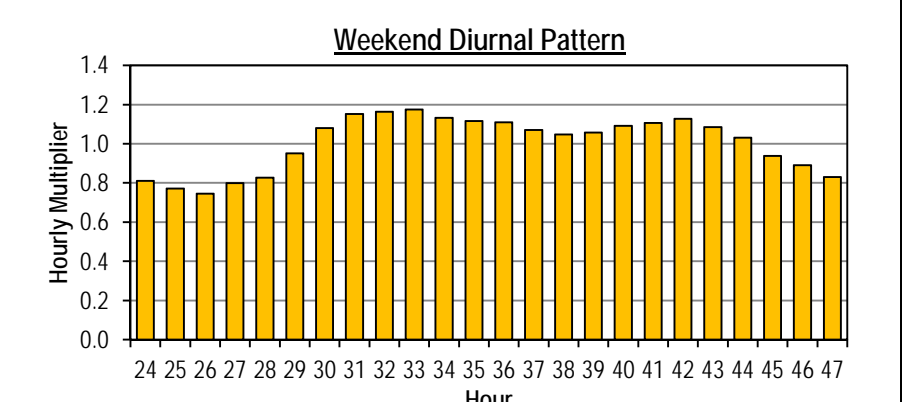
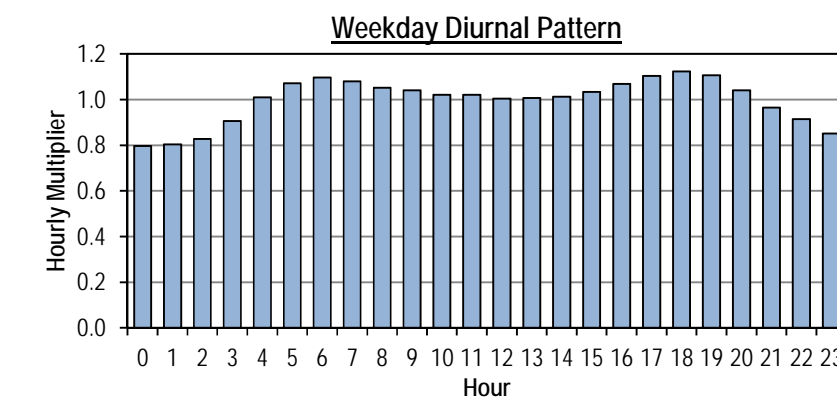
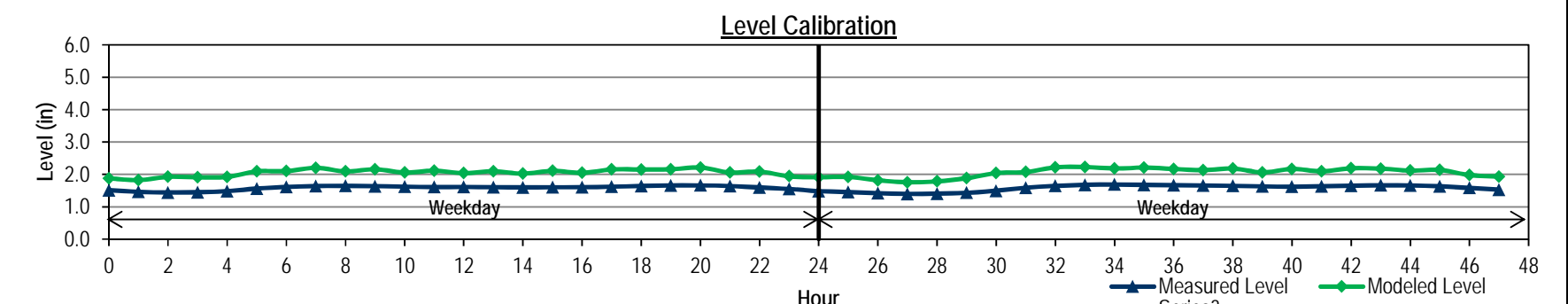
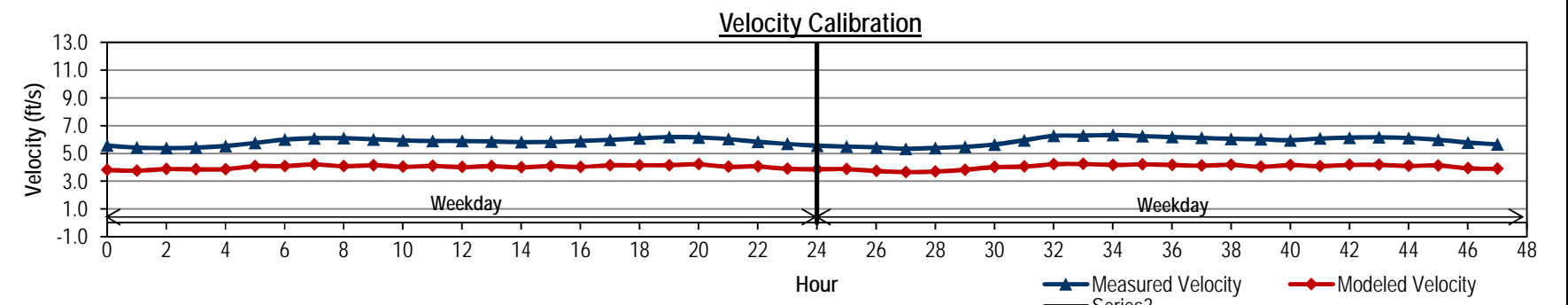
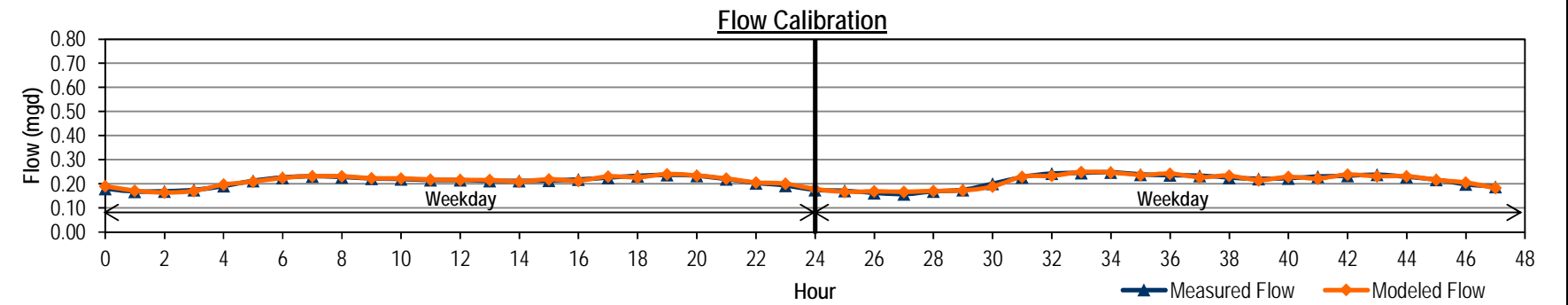



City of Renton
Long-range Wastewater Management Plan
FLOW MONITORING SITE MH5519 DRY WEATHER FLOW CALIBRATION



Hour	Measured Data			Modeled Data			Level Diff (in)	Diurnal		
	Flow (mgd)	Level (in)	Velocity (ft/s)	Flow (mgd)	Level (in)	Velocity (ft/s)		Initial Curve	Modified Curve	Calibrated Diurnal
0	0.205	1.8	4.91	0.208	2.3	4.52	-0.51	0.61		0.61
1	0.192	1.7	4.73	0.195	2.2	4.45	-0.50	0.60		0.60
2	0.188	1.7	4.64	0.193	2.2	4.44	-0.53	0.63		0.63
3	0.197	1.7	4.65	0.208	2.3	4.55	-0.63	0.76		0.76
4	0.238	1.8	4.96	0.252	2.6	4.82	-0.80	0.96		0.96
5	0.300	1.9	5.50	0.310	2.8	5.12	-0.91	1.09		1.09
6	0.341	2.1	5.98	0.348	2.9	5.26	-0.86	1.14		1.14
7	0.357	2.2	6.16	0.364	3.0	5.35	-0.86	1.17		1.17
8	0.365	2.2	6.19	0.373	3.1	5.38	-0.87	1.19		1.19
9	0.374	2.2	6.29	0.379	3.1	5.41	-0.87	1.19		1.19
10	0.373	2.2	6.31	0.381	3.1	5.42	-0.87	1.21		1.21
11	0.380	2.2	6.34	0.386	3.1	5.44	-0.87	1.21		1.21
12	0.379	2.2	6.38	0.384	3.1	5.43	-0.85	1.19		1.19
13	0.373	2.2	6.30	0.380	3.1	5.41	-0.85	1.20		1.20
14	0.374	2.2	6.30	0.380	3.1	5.41	-0.86	1.19		1.19
15	0.373	2.2	6.31	0.381	3.1	5.42	-0.86	1.22		1.22
16	0.380	2.2	6.30	0.386	3.1	5.43	-0.89	1.21		1.21
17	0.377	2.2	6.35	0.384	3.1	5.43	-0.86	1.20		1.20
18	0.377	2.2	6.32	0.380	3.1	5.41	-0.84	1.16		1.16
19	0.364	2.2	6.28	0.366	3.0	5.35	-0.80	1.10		1.10
20	0.345	2.2	6.19	0.343	2.9	5.25	-0.73	0.98		0.98
21	0.308	2.1	5.89	0.307	2.8	5.08	-0.65	0.87		0.87
22	0.271	2.0	5.63	0.269	2.6	4.88	-0.56	0.74		0.74
23	0.231	1.9	5.29	0.233	2.4	4.67	-0.49	0.65		0.65
24	0.206	1.8	5.17	0.211	2.3	4.54	-0.50	0.61		0.61
25	0.192	1.7	4.72	0.206	2.3	4.52	-0.58	0.57		0.57
26	0.178	1.7	4.54	0.196	2.2	4.45	-0.54	0.56		0.56
27	0.177	1.7	4.47	0.194	2.2	4.45	-0.58	0.58		0.58
28	0.183	1.7	4.54	0.206	2.3	4.54	-0.66	0.69		0.69
29	0.217	1.7	4.80	0.246	2.5	4.78	-0.82	0.87		0.87
30	0.271	1.8	5.32	0.306	2.8	5.10	-0.99	1.05		1.05
31	0.328	2.0	5.82	0.366	3.0	5.36	-1.05	1.19		1.19
32	0.372	2.2	6.22	0.408	3.2	5.53	-1.03	1.23		1.23
33	0.386	2.2	6.40	0.423	3.2	5.59	-1.01	1.26		1.26
34	0.395	2.3	6.50	0.430	3.3	5.61	-1.01	1.25		1.25
35	0.392	2.3	6.53	0.424	3.2	5.58	-0.98	1.20		1.20
36	0.376	2.2	6.48	0.407	3.2	5.52	-0.94	1.15		1.15
37	0.361	2.2	6.24	0.391	3.1	5.45	-0.93	1.11		1.11
38	0.347	2.2	6.21	0.378	3.1	5.40	-0.91	1.09		1.09
39	0.341	2.1	6.18	0.368	3.0	5.36	-0.89	1.03		1.03
40	0.323	2.1	6.00	0.358	3.0	5.32	-0.91	1.08		1.08
41	0.337	2.1	6.11	0.370	3.0	5.37	-0.93	1.11		1.11
42	0.349	2.1	6.11	0.373	3.0	5.38	-0.91	1.02		1.02
43	0.320	2.1	6.12	0.351	3.0	5.28	-0.84	1.02		1.02
44	0.318	2.1	5.95	0.337	2.9	5.22	-0.83	0.89		0.89
45	0.279	2.0	5.81	0.299	2.7	5.03	-0.71	0.78		0.78
46	0.245	1.9	5.50	0.269	2.6	4.88	-0.70	0.77		0.77
47	0.241	1.8	5.25	0.255	2.5	4.81	-0.68	0.66		0.66
Average										
Weekday	0.319	2.1	5.84	0.325	2.8	5.14		1.02	#DIV/0!	1.02
Weekend	0.297	2.0	5.71	0.324	2.8	5.13		0.95	#DIV/0!	0.95
ADWF ⁽¹⁾	0.313	2.1	5.80	0.324	2.8	5.13		1.00	#DIV/0!	1.00
% Error										
Weekday				1.7%			0.91			
Weekend				9.1%			1.05			

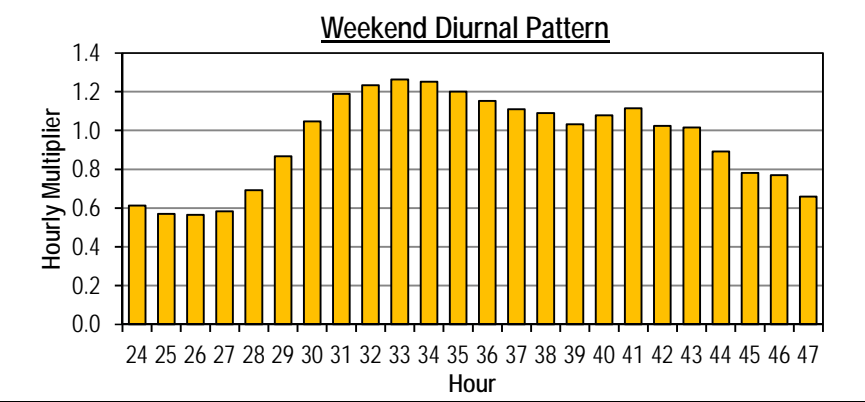
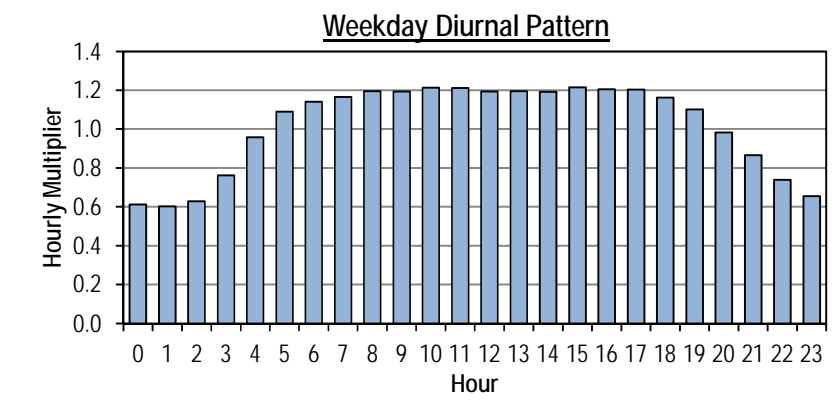
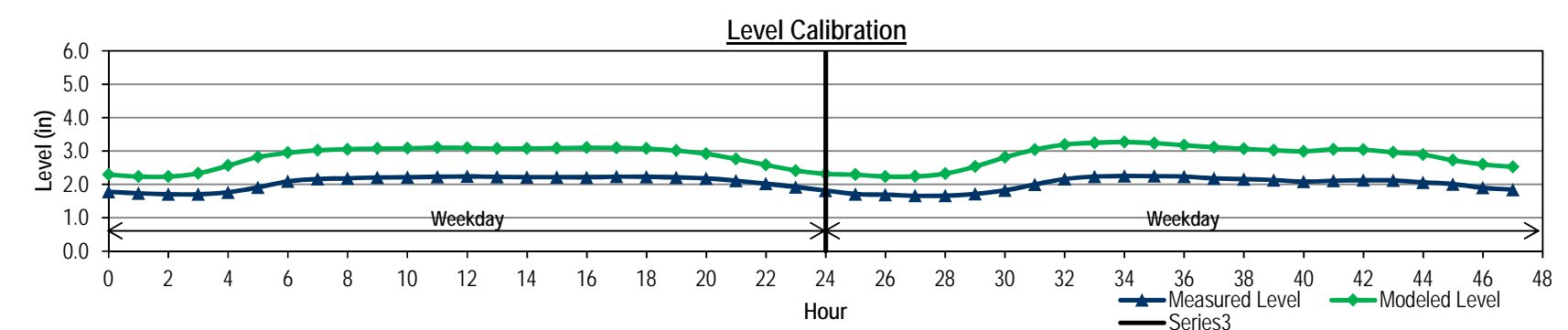
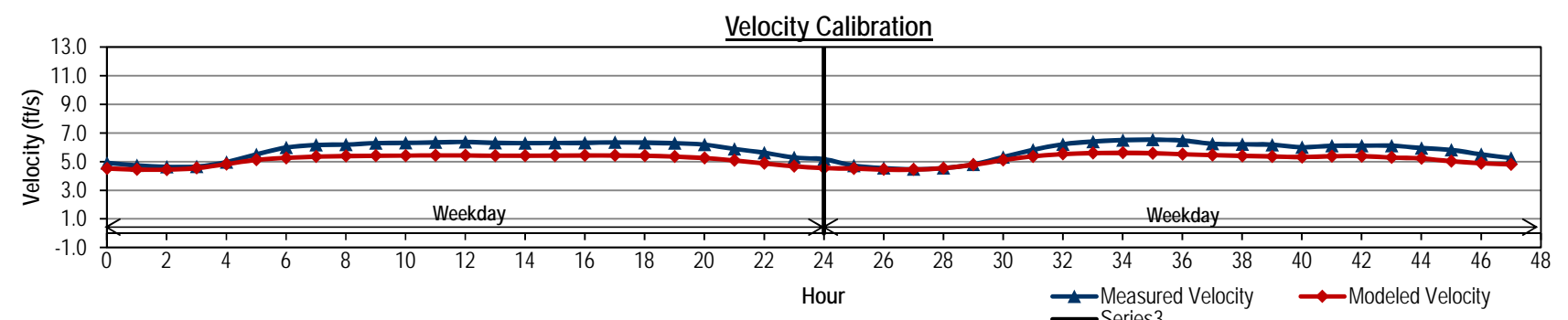
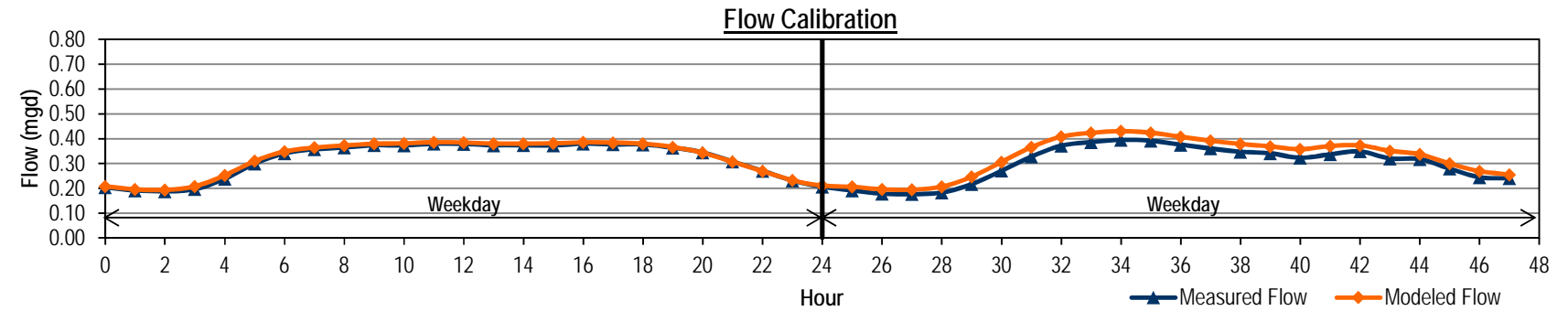



**City of Renton
Long-range Wastewater Management Plan
FLOW MONITORING SITE MH6041 DRY WEATHER FLOW CALIBRATION**



Hour	Measured Data			Modeled Data			Level Diff (in)	Diurnal		
	Flow (mgd)	Level (in)	Velocity (ft/s)	Flow (mgd)	Level (in)	Velocity (ft/s)		Initial Curve	Modified Curve	Calibrated Diurnal
0	0.022	0.7	2.75	0.021	1.5	1.18	-0.79			0.39
1	0.018	0.6	2.34	0.017	1.3	1.13	-0.74			0.39
2	0.018	0.6	2.18	0.018	1.4	1.16	-0.80			0.50
3	0.023	0.6	2.31	0.024	1.6	1.27	-0.98			0.71
4	0.032	0.7	2.83	0.033	1.8	1.42	-1.16			0.95
5	0.043	0.8	3.47	0.042	2.1	1.53	-1.30			1.10
6	0.050	0.8	3.91	0.049	2.2	1.60	-1.37			1.17
7	0.053	0.8	3.99	0.052	2.2	1.63	-1.41			1.23
8	0.056	0.9	4.24	0.054	2.3	1.65	-1.43			1.26
9	0.057	0.9	4.34	0.055	2.3	1.66	-1.44			1.24
10	0.057	0.9	4.38	0.056	2.3	1.67	-1.47			1.34
11	0.061	0.9	4.40	0.058	2.4	1.69	-1.50			1.32
12	0.060	0.9	4.42	0.056	2.3	1.67	-1.44			1.20
13	0.055	0.9	4.34	0.052	2.2	1.62	-1.35			1.11
14	0.051	0.8	3.97	0.049	2.2	1.59	-1.34			1.08
15	0.049	0.8	3.85	0.049	2.2	1.60	-1.36			1.20
16	0.055	0.9	3.94	0.055	2.3	1.67	-1.45			1.41
17	0.064	0.9	4.23	0.061	2.4	1.72	-1.52			1.41
18	0.064	0.9	4.38	0.062	2.4	1.73	-1.52			1.43
19	0.065	1.0	4.39	0.061	2.4	1.72	-1.46			1.32
20	0.060	0.9	4.28	0.056	2.3	1.66	-1.38			1.13
21	0.052	0.9	4.03	0.046	2.1	1.55	-1.24			0.84
22	0.038	0.8	3.76	0.035	1.9	1.42	-1.04			0.65
23	0.030	0.7	3.21	0.027	1.6	1.29	-0.94			0.47
24	0.020	0.6	2.86	0.022	1.5	1.22	-0.89			0.45
25	0.021	0.6	2.58	0.022	1.5	1.21	-0.91			0.39
26	0.018	0.6	2.35	0.020	1.4	1.18	-0.83			0.39
27	0.018	0.6	2.14	0.019	1.4	1.17	-0.82			0.39
28	0.018	0.6	2.35	0.022	1.5	1.23	-0.93			0.57
29	0.026	0.6	2.68	0.031	1.8	1.38	-1.18			0.79
30	0.036	0.7	3.22	0.042	2.1	1.54	-1.39			1.05
31	0.048	0.7	3.82	0.054	2.3	1.66	-1.57			1.23
32	0.056	0.8	4.28	0.061	2.4	1.72	-1.62			1.26
33	0.057	0.8	4.51	0.062	2.4	1.73	-1.58			1.23
34	0.056	0.8	4.46	0.061	2.4	1.71	-1.57			1.19
35	0.054	0.8	4.31	0.059	2.4	1.69	-1.53			1.13
36	0.052	0.8	4.33	0.056	2.3	1.67	-1.49			1.10
37	0.050	0.8	4.31	0.057	2.3	1.68	-1.53			1.22
38	0.056	0.8	4.18	0.058	2.4	1.69	-1.56			1.08
39	0.049	0.8	4.27	0.054	2.3	1.65	-1.48			1.09
40	0.050	0.8	4.16	0.056	2.3	1.67	-1.52			1.21
41	0.055	0.8	4.14	0.057	2.3	1.67	-1.49			1.01
42	0.046	0.8	4.15	0.053	2.3	1.64	-1.43			1.13
43	0.052	0.8	3.95	0.056	2.3	1.66	-1.53			1.10
44	0.050	0.8	4.20	0.054	2.3	1.64	-1.46			1.04
45	0.047	0.8	4.12	0.048	2.1	1.57	-1.33			0.78
46	0.036	0.8	3.71	0.037	1.9	1.44	-1.13			0.58
47	0.027	0.7	3.20	0.028	1.7	1.31	-1.01			0.44
Average										
Weekday	0.047	0.8	3.75	0.045	2.1	1.53		1.04	#DIV/0!	1.04
Weekend	0.041	0.7	3.68	0.045	2.1	1.53		0.91	#DIV/0!	0.91
ADWF ⁽¹⁾	0.045	0.8	3.73	0.045	2.1	1.53		1.00	#DIV/0!	1.00
% Error										
Weekday				-3.5%			1.52			
Weekend				9.6%			1.62			
Note:										

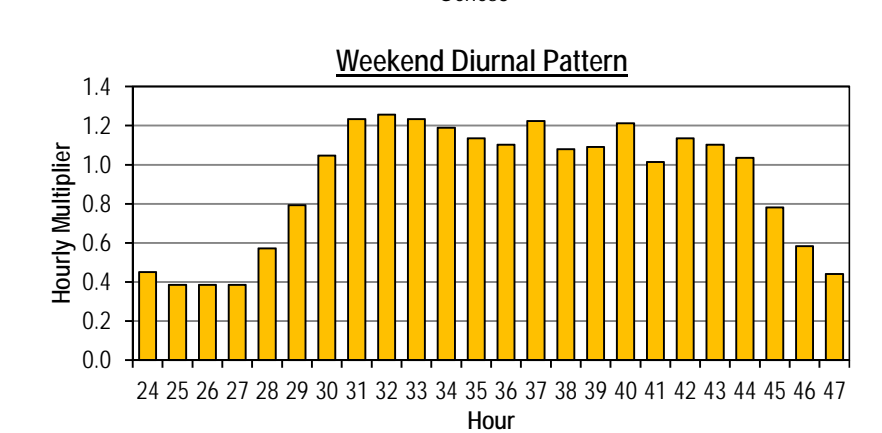
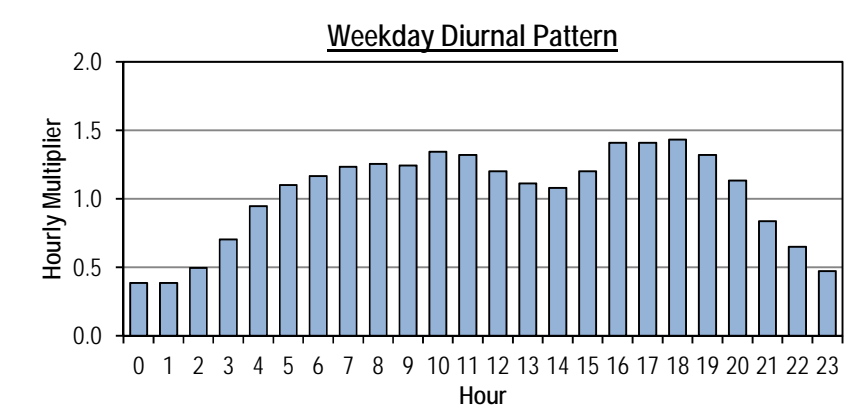
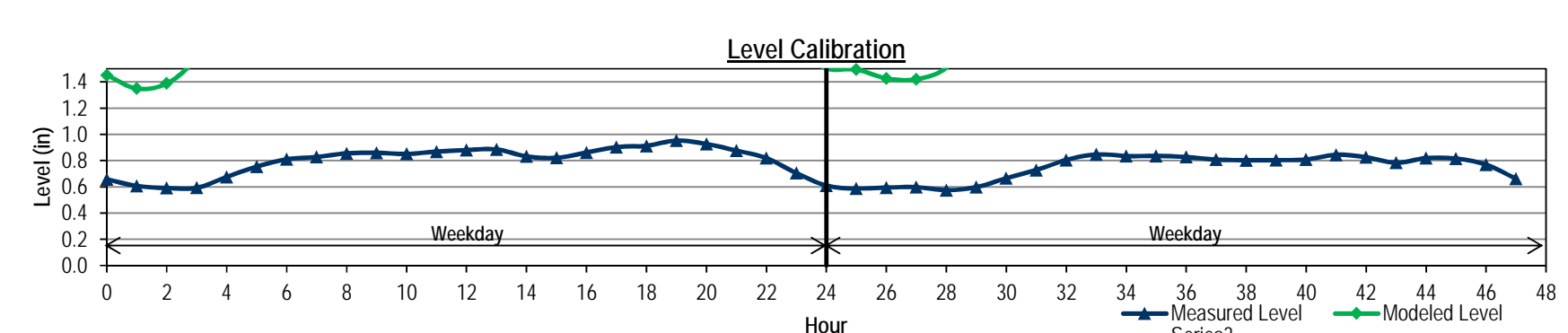
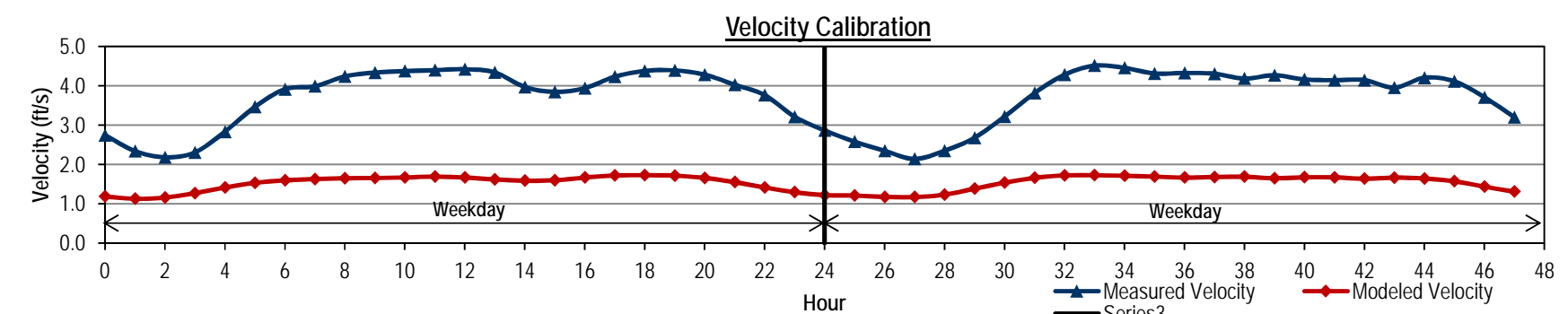
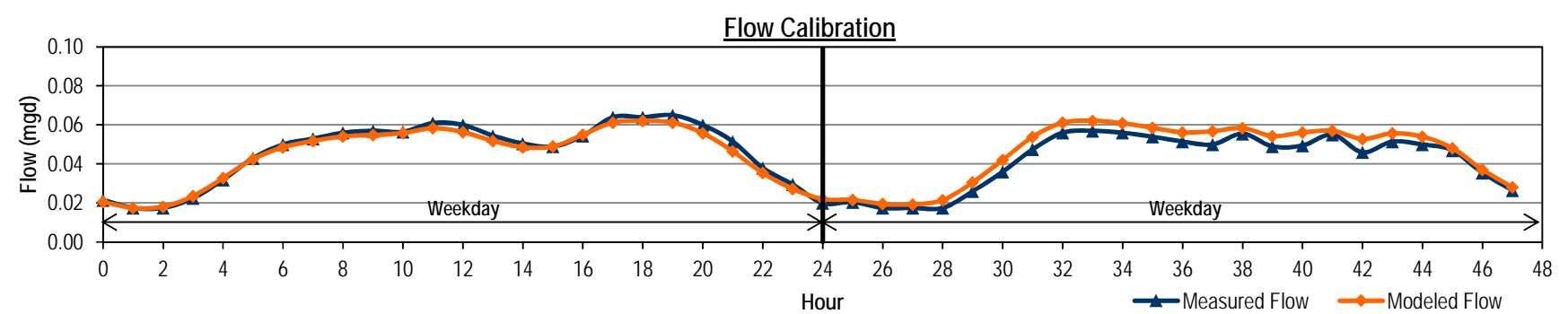



City of Renton
Long-range Wastewater Management Plan
FLOW MONITORING SITE MH6704 DRY WEATHER FLOW CALIBRATION



Hour	Measured Data			Modeled Data			Level Diff (in)	Diurnal		
	Flow (mgd)	Level (in)	Velocity (ft/s)	Flow (mgd)	Level (in)	Velocity (ft/s)		Initial Curve	Modified Curve	Calibrated Diurnal
0	0.068	0.8	4.46	0.072	1.6	4.79	-0.73	0.54		0.54
1	0.065	0.8	4.37	0.068	1.5	4.73	-0.72	0.54		0.54
2	0.065	0.8	4.31	0.067	1.5	4.73	-0.74	0.57		0.57
3	0.067	0.8	4.32	0.071	1.6	4.82	-0.77	0.67		0.67
4	0.080	0.8	4.42	0.083	1.7	5.09	-0.89	0.87		0.87
5	0.103	0.9	4.93	0.105	1.9	5.46	-1.00	1.00		1.00
6	0.119	1.0	5.50	0.121	2.1	5.68	-1.07	1.02		1.02
7	0.121	1.0	5.72	0.126	2.1	5.72	-1.07	1.05		1.05
8	0.125	1.0	5.77	0.129	2.1	5.77	-1.10	1.07		1.07
9	0.127	1.0	5.96	0.132	2.1	5.80	-1.10	1.10		1.10
10	0.130	1.0	5.94	0.135	2.2	5.84	-1.13	1.12		1.12
11	0.133	1.0	6.13	0.137	2.2	5.87	-1.14	1.11		1.11
12	0.132	1.0	6.16	0.136	2.2	5.86	-1.14	1.11		1.11
13	0.132	1.0	6.05	0.136	2.2	5.85	-1.13	1.08		1.08
14	0.128	1.0	6.01	0.134	2.2	5.83	-1.11	1.13		1.13
15	0.135	1.0	6.00	0.141	2.2	5.93	-1.17	1.24		1.24
16	0.148	1.1	6.15	0.152	2.3	6.07	-1.22	1.30		1.30
17	0.154	1.1	6.41	0.158	2.3	6.13	-1.24	1.27		1.27
18	0.151	1.1	6.46	0.156	2.3	6.09	-1.21	1.25		1.25
19	0.148	1.1	6.42	0.152	2.3	6.05	-1.20	1.19		1.19
20	0.141	1.1	6.33	0.141	2.2	5.90	-1.10	0.92		0.92
21	0.110	1.0	5.90	0.115	2.0	5.50	-0.94	0.75		0.75
22	0.089	0.9	5.27	0.094	1.8	5.18	-0.85	0.65		0.65
23	0.077	0.9	4.83	0.081	1.7	4.96	-0.78	0.57		0.57
24	0.081	0.9	4.63	0.072	1.6	4.80	-0.66	0.62		0.62
25	0.074	0.9	4.48	0.068	1.5	4.73	-0.65	0.59		0.59
26	0.070	0.9	4.36	0.064	1.5	4.65	-0.64	0.57		0.57
27	0.067	0.8	4.31	0.062	1.5	4.62	-0.64	0.59		0.59
28	0.070	0.8	4.29	0.065	1.5	4.71	-0.70	0.72		0.72
29	0.085	0.9	4.53	0.078	1.7	5.01	-0.82	0.94		0.94
30	0.112	1.0	4.96	0.102	1.9	5.41	-0.94	1.17		1.17
31	0.139	1.0	5.72	0.126	2.1	5.76	-1.07	1.32		1.32
32	0.157	1.1	6.22	0.145	2.3	5.99	-1.14	1.52		1.52
33	0.181	1.2	6.46	0.163	2.4	6.21	-1.21	1.57		1.57
34	0.187	1.2	6.86	0.168	2.4	6.24	-1.20	1.48		1.48
35	0.176	1.2	6.89	0.163	2.4	6.17	-1.16	1.51		1.51
36	0.179	1.2	6.79	0.162	2.4	6.17	-1.18	1.43		1.43
37	0.170	1.2	6.78	0.154	2.3	6.07	-1.14	1.32		1.32
38	0.157	1.1	6.61	0.145	2.2	5.95	-1.08	1.31		1.31
39	0.155	1.1	6.45	0.142	2.2	5.93	-1.09	1.29		1.29
40	0.154	1.1	6.38	0.140	2.2	5.91	-1.08	1.28		1.28
41	0.152	1.1	6.45	0.138	2.2	5.88	-1.07	1.25		1.25
42	0.148	1.1	6.29	0.136	2.2	5.85	-1.07	1.26		1.26
43	0.149	1.1	6.35	0.135	2.2	5.83	-1.04	1.18		1.18
44	0.140	1.1	6.11	0.126	2.1	5.70	-0.98	1.01		1.01
45	0.120	1.0	6.02	0.110	1.9	5.44	-0.89	0.86		0.86
46	0.102	1.0	5.56	0.093	1.8	5.19	-0.79	0.72		0.72
47	0.085	0.9	4.95	0.080	1.7	4.95	-0.73	0.68		0.68
Average										
Weekday	0.114	1.0	5.58	0.118	2.0	5.57		0.96	#DIV/0!	0.96
Weekend	0.129	1.0	5.77	0.118	2.0	5.55		1.09	#DIV/0!	1.09
ADWF ⁽¹⁾	0.119	1.0	5.63	0.118	2.0	5.56		1.00	#DIV/0!	1.00
% Error										
Weekday				3.6%			1.24			
Weekend				-8.6%			1.21			
Note:										

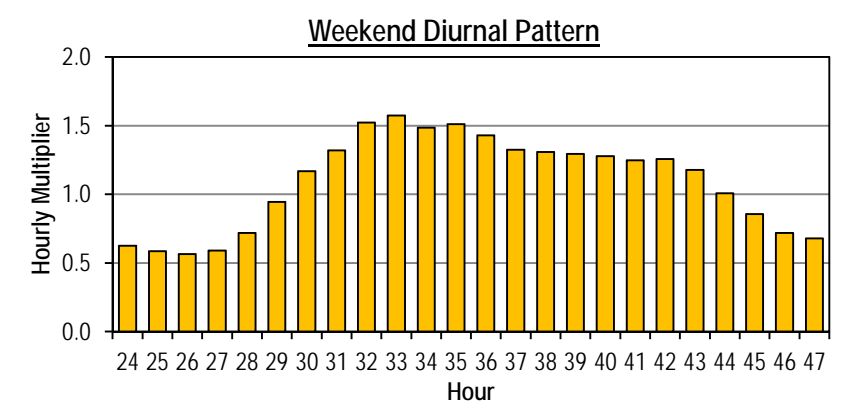
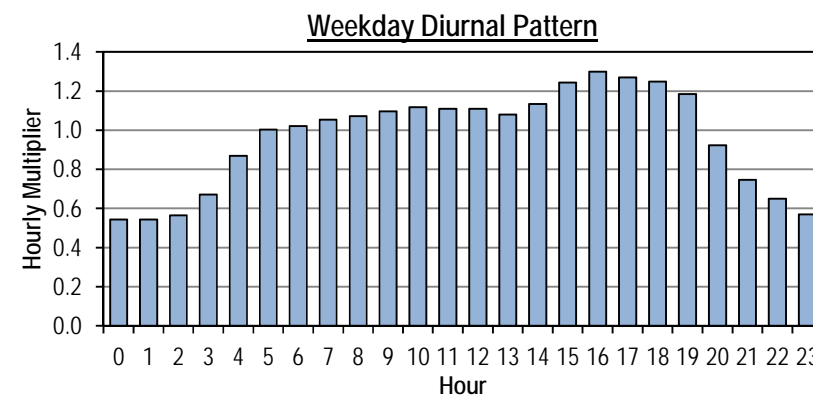
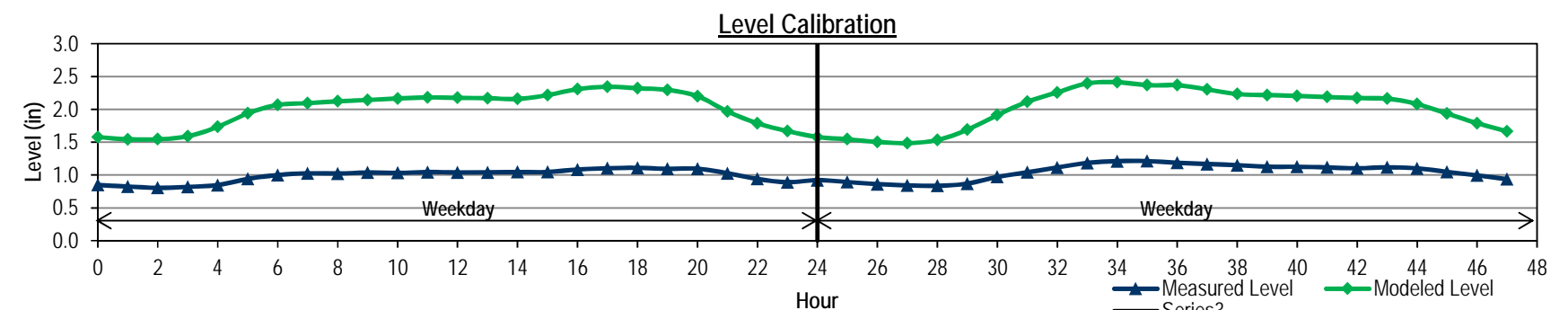
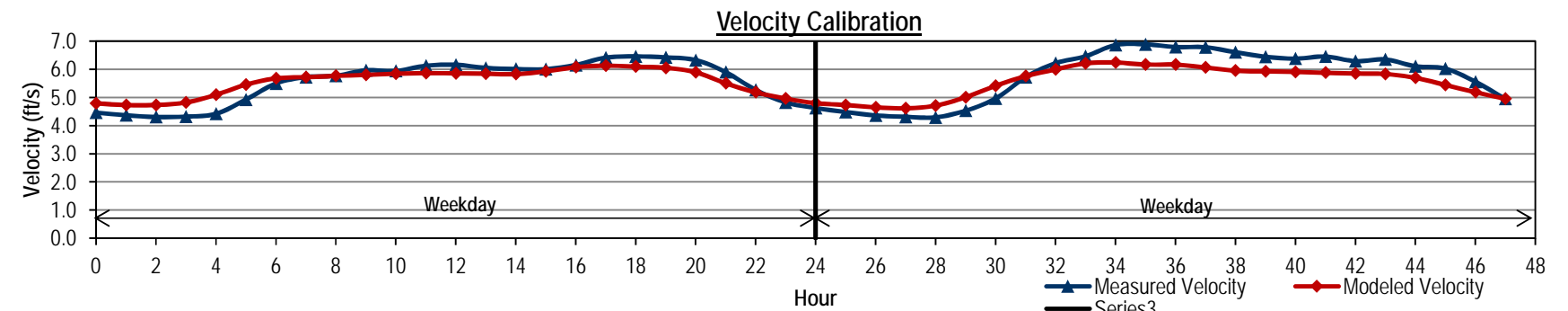
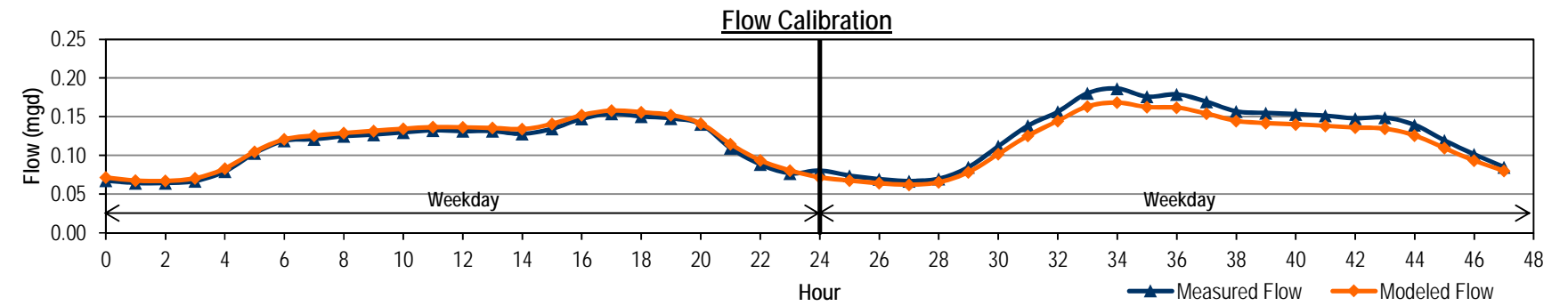

Attachment G
WET WEATHER CALIBRATION RESULTS

Table 1 Wet Weather Calibration
Long-range Wastewater Management Plan
City of Renton

Meter Number	Pipe Diameter (in)	Storm 1 (12/26/2017-1/3/2018)												Storm 2 (1/23/2018-2/7/2018)												Storm 3 (4/6/2018-4/22/2018)											
		Measured Data ⁽¹⁾					Modeled Data ⁽²⁾					Percent Error ⁽³⁾		Max	Measured Data ⁽¹⁾				Modeled Data ⁽²⁾				Percent Error ⁽³⁾		Max	Measured Data ⁽¹⁾				Modeled Data ⁽²⁾				Percent Error ⁽³⁾		Max	
		Total Flow (MG)	Avg. Flow (mgd)	Peak Flow (mgd)	Avg. Velocity (ft/s)	Avg. Level (in)	Total Flow (MG)	Avg. Flow (mgd)	Peak Flow (mgd)	Avg. Velocity (ft/s)	Avg. Level (in)	Volume Flow (%)	Peak Flow (%)	Level Diff (inches)	Total Flow (MG)	Avg. Flow (mgd)	Peak Flow (mgd)	Avg. Level (in)	Total Flow (MG)	Avg. Flow (mgd)	Peak Flow (mgd)	Avg. Level (in)	Volume Flow (%)	Peak Flow (%)	Level Diff (inches)	Total Flow (MG)	Avg. Flow (mgd)	Peak Flow (mgd)	Avg. Velocity (ft/s)	Avg. Level (in)	Volume Flow (%)	Peak Flow (%)	Level Diff (inches)				
MH0166	12	16.1	0.074	1.109	0.87	1.6	23.3	0.108	1.092	1.23	2.2	31.1%	-1.5%	5.1	51.6	0.134	1.238	2.4	50.1	0.131	1.385	2.6	-3.0%	11.9%	21.0	44.9	0.110	1.206	2.2	53.0	0.130	1.195	0.78	1.7	15.4%	-0.9%	7.4
MH0286	10	15.1	0.070	0.133	0.68	3.3	16.3	0.075	0.131	1.00	2.3	7.2%	-1.8%	1.5	29.2	0.076	0.139	3.4	29.2	0.076	0.122	2.3	0.1%	-11.9%	1.7	30.8	0.080	0.151	3.6	28.5	0.074	0.112	0.99	2.3	-7.8%	-25.8%	1.8
MH0537	8	74.2	0.344	0.527	8.96	1.8	82.5	0.382	0.537	7.74	2.3	10.1%	2.0%	0.2	144.5	0.377	0.551	1.9	152.5	0.398	0.515	2.4	5.2%	-6.6%	0.9	123.4	0.321	0.479	1.7	149.0	0.387	0.542	7.78	0.0	17.2%	13.3%	1.1
MH1360	10.75	77.7	0.360	0.903	4.00	2.8	94.8	0.439	0.990	2.32	5.2	18.1%	9.7%	5.7	215.2	0.561	0.998	3.7	190.7	0.497	1.070	5.6	-12.8%	7.2%	5.8	153.8	0.400	0.901	3.0	181.1	0.471	0.923	2.36	5.4	15.1%	2.5%	6.0
MH1763	15	51.9	0.240	0.585	0.43	10.3	59.6	0.276	0.665	0.35	7.5	13.0%	13.7%	6.2	159.1	0.415	0.677	11.4	114.6	0.299	0.575	8.0	-38.9%	-15.0%	6.4	109.1	0.284	0.571	90.0	108.7	0.283	0.543	0.36	7.8	-0.3%	-5.0%	5.3
MH2116	14.5	0.0	0.000	0.000	0.00	0.0	205.9	0.953	2.308	2.36	8.3				451.9	1.179	2.213	8.4	412.6	1.076	1.934	8.8	-9.5%	-12.6%	6.0	397.6	1.034	2.040	7.0	413.0	1.074	2.190	2.45	8.8	3.7%	7.3%	4.0
MH2171	11.25	54.4	0.252	0.781	1.35	4.7	58.3	0.270	0.867	1.41	5.7	6.8%	10.9%	3.5	118.6	0.309	0.694	5.1	111.2	0.290	0.748	6.0	-6.7%	7.7%	2.4	92.3	0.240	0.525	4.5	111.7	0.290	0.627	1.44	6.0	17.3%	19.5%	3.8
MH2252	18	205.6	0.951	2.800	5.37	3.7	200.7	0.929	2.638	3.09	3.8	-2.5%	-5.8%	1.6	417.6	1.089	2.664	3.9	381.8	0.996	2.988	4.0	-9.4%	12.2%	1.6	356.0	0.926	1.958	3.7	387.6	1.007	3.099	3.17	4.0	8.1%	58.3%	2.0
MH2999	8	52.9	0.245	0.556	5.79	1.9	59.4	0.275	0.495	4.73	2.8	11.0%	-10.9%	1.3	102.4	0.267	0.457	2.0	115.4	0.301	0.465	2.9	11.3%	1.8%	1.3	95.0	0.247	0.453	1.9	114.3	0.297	0.485	4.84	2.9	16.8%	7.0%	1.4
MH3216	7.38	11.1	0.051	0.218	0.65	2.9	13.6	0.063	0.208	1.09	2.9	18.8%	-4.4%	2.9	28.1	0.073	0.115	2.7	25.3	0.066	0.144	3.0	-11.3%	25.2%	1.7	22.6	0.059	0.101	2.6	26.1	0.068	0.149	1.11	3.0	13.5%	47.8%	1.9
MH3625	12	158.9	0.736	1.379	2.79	6.1	166.7	0.772	1.448	3.14	5.6	4.7%	5.0%	3.1	357.8	0.933	1.507	7.0	311.9	0.814	1.414	5.8	-14.7%	-6.1%	3.8	313.8	0.816	1.487	6.4	308.4	0.802	1.360	3.18	5.7	-1.7%	-8.5%	3.7
MH4628	10.38	61.2	0.284	0.757	4.95	2.1	68.3	0.316	0.783	4.48	0.9	10.4%	3.5%	2.2	165.3	0.431	0.770	2.8	136.3	0.356	0.885	1.0	-21.2%	15.0%	2.6	115.9	0.301	0.752	2.2	130.1	0.338	0.740	4.57	0.9	10.9%	-1.6%	2.3
MH4646	8	48.6	0.225	0.298	9.28	1.3	47.7	0.221	0.278	8.12	5.2	-1.9%	-6.6%	5.4	102.3	0.267	0.341	1.5	86.5	0.226	0.274	5.4	-18.3%	-19.7%	5.4	89.3	0.232	0.286	1.3	87.4	0.227	0.291	8.19	5.4	-2.2%	1.9%	5.6
MH5302	14	525.7	2.434	5.106	3.74	9.5	503.9	2.333	4.663	4.34	7.6	-4.3%	-8.7%	3.8	1043.8	2.722	4.054	10.2	967.4	2.525	4.327	7.9	-7.9%	6.7%	4.5	966.8	2.514	4.403	9.8	951.3	2.472	4.439	4.41	7.8	-1.6%	0.8%	4.3
MH5505	10	68.8	0.319	0.585	6.69	1.9	73.7	0.341	0.573	4.62	2.6	6.6%	-1.9%	1.5	151.8	0.396	0.576	2.1	138.6	0.362	0.612	2.7	-9.5%	6.3%	1.2	137.6	0.337	0.642	2.0	134.6	0.329	0.548	2.49	1.4	-2.2%	-14.7%	2.8
MH5519	10.25	67.5	0.313	0.480	5.84	2.0	77.0	0.356	0.639	5.27	2.9	12.2%	33.1%	1.5	123.8	0.323	0.447	2.1	139.1	0.363	0.555	3.0	10.9%	24.0%	1.4	126.1	0.328	0.534	13.4	139.7	0.363	0.541	5.31	3.0	9.8%	1.3%	21.3
MH6041	8	19.6	0.090	0.300	2.66	1.6	17.1	0.079	0.273	1.82	2.6	-14.5%	-8.9%	2.6	28.0	0.073	0.132	0.9	33.5	0.087	0.158	2.8	16.5%	19.7%	2.6	21.7	0.057	0.100	0.9	35.8	0.093	0.241	1.95	2.8	39.3%	140.3%	3.5
MH6704	12	35.5	0.164	0.384	7.43	1.0	32.7	0.152	0.310	5.89	2.3	-8.4%	-19.1%	1.9	50.6	0.132	0.229	1.0	60.7	0.158	0.279	2.3	16.7%	21.8%	2.0	52.6	0.137	0.262	1.0	62.0	0.161	0.269	5.97	2.3	15.2%	3.0%	1.9

Notes:
1. Source: City of Renton 2018 Temporary Flow Monitoring Program, ADS
2. Average flows are computed from hydraulic modeling results. Maximum flow values are hourly peaks.
3. Percent Difference = (Modeled - Measured)/Measured*100.



Location: Springbrook Trail
Pipeline diameter: 12"
City Manhole ID: MH0166
Model Manhole ID:
Silt Level at Site: "

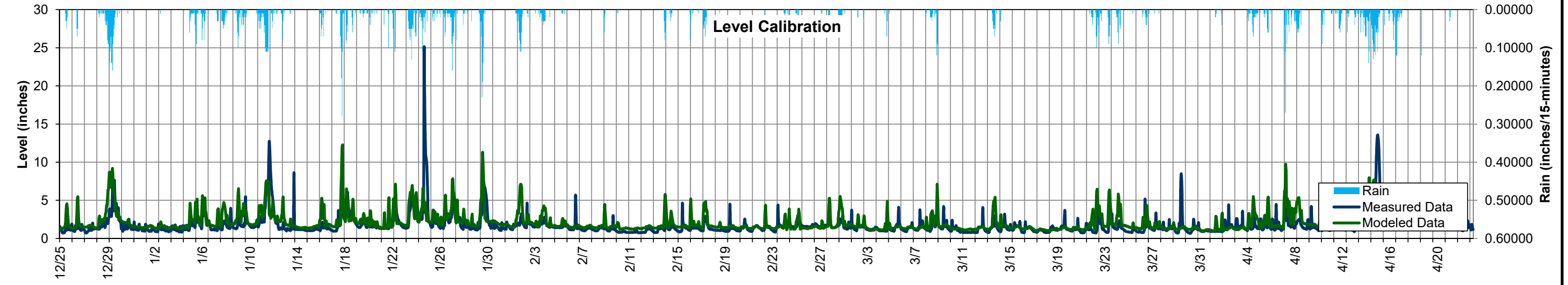
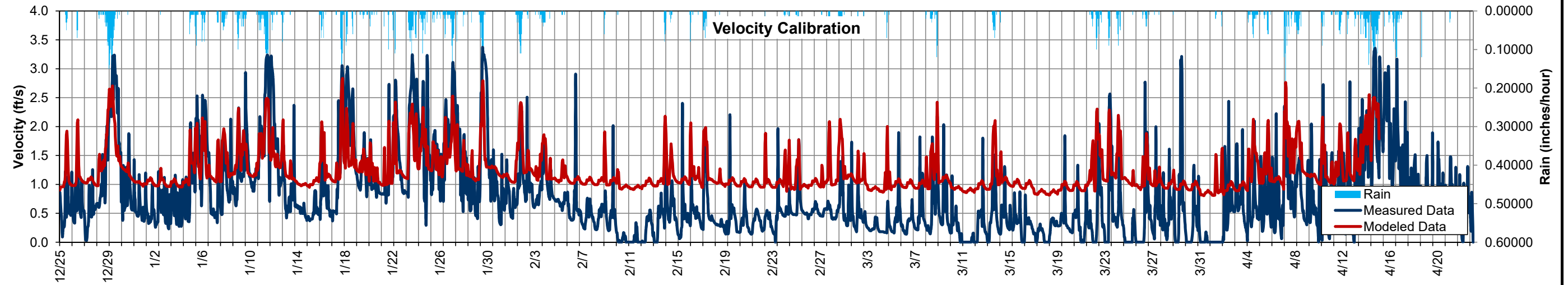
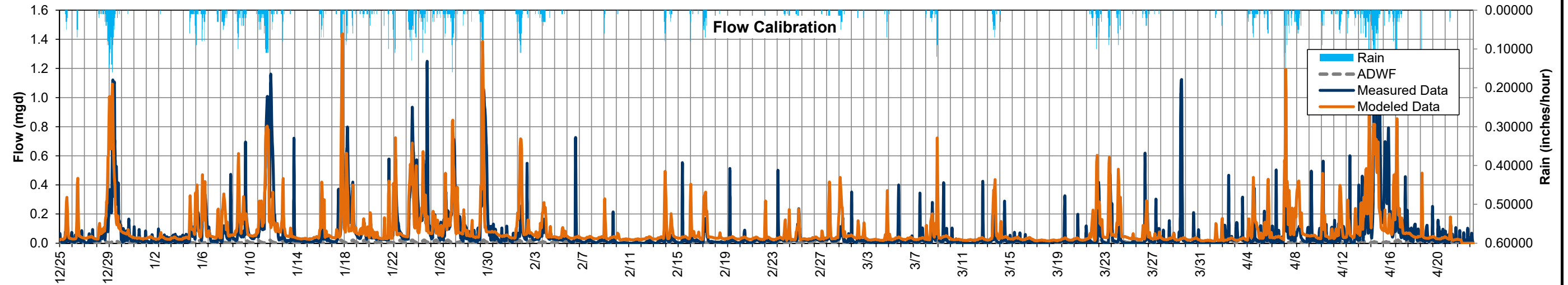



FLOW MONITORING MH0286 WET WEATHER FLOW CALIBRATION
Long-range Wastewater Management Plan
City of Renton



Location: Oakeside Ave and SW Grady Way
Pipeline diameter: 15"
City Manhole ID: MH0286
Model Manhole ID:
Silt Level at Site: "

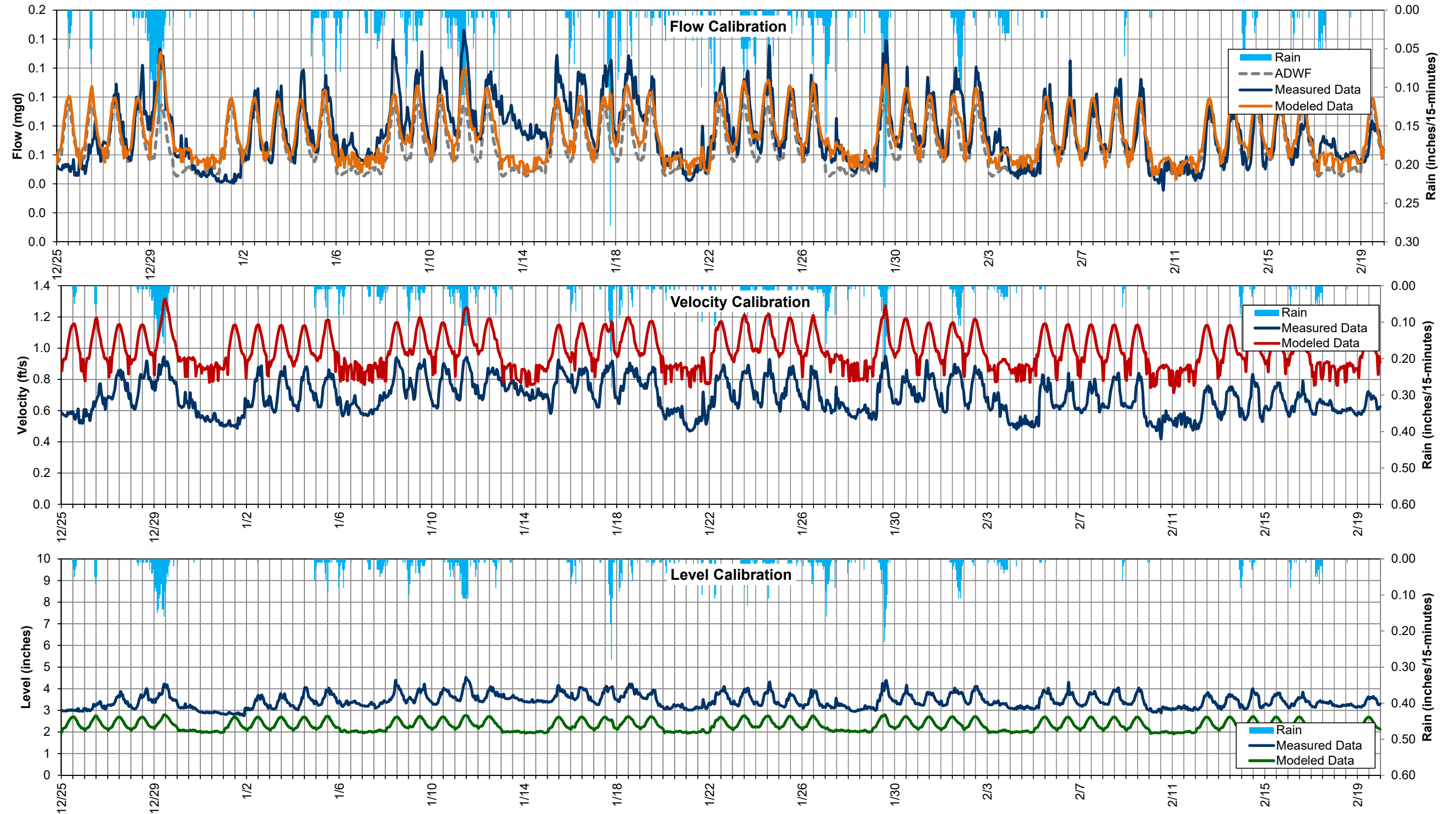



Location: 2803 Burnett Ave
Pipeline diameter: 8"
City Manhole ID: MH0537
Model Manhole ID:
Silt Level at Site: "

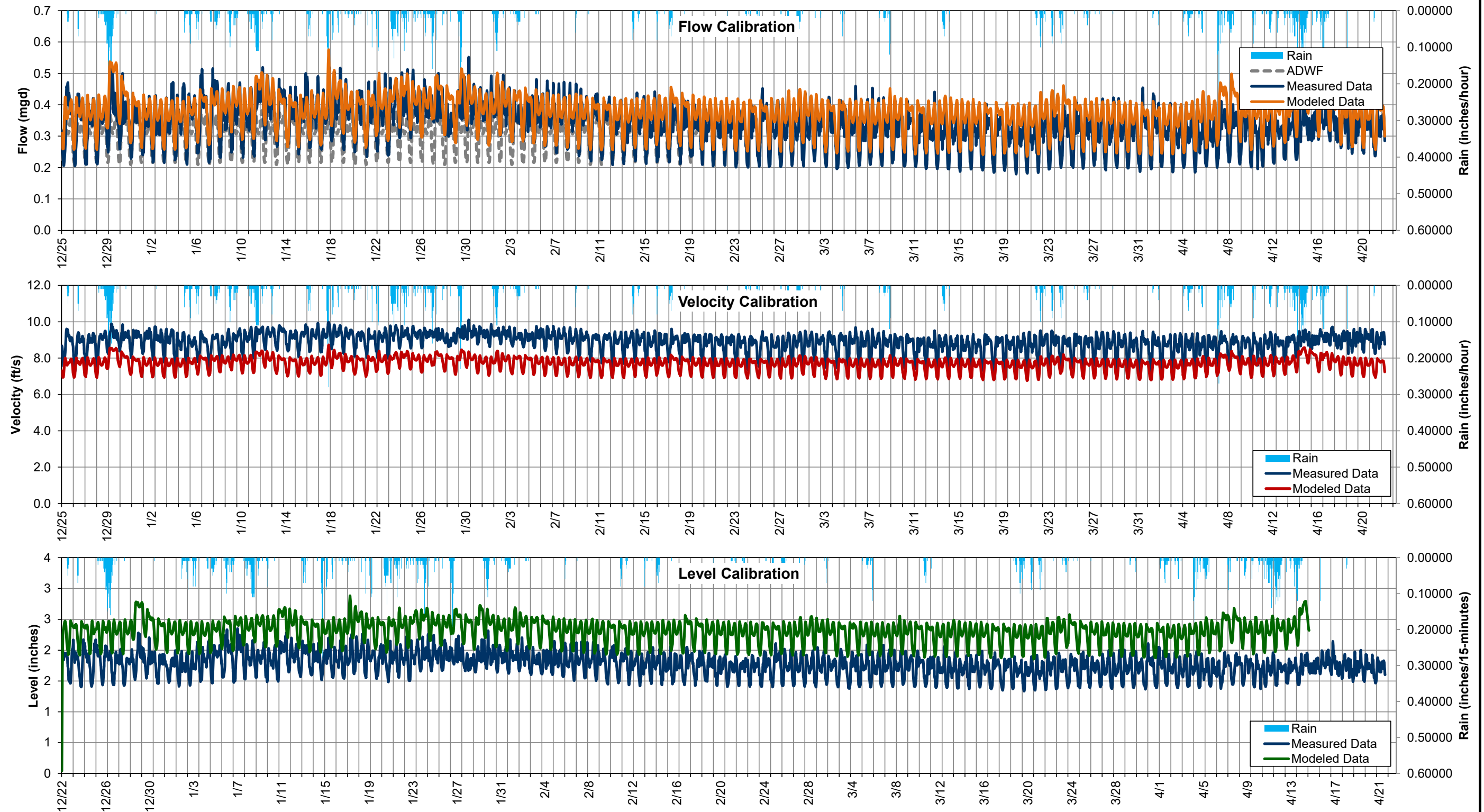



FLOW MONITORING MH1360 WET WEATHER FLOW CALIBRATION
Long-range Wastewater Management Plan
City of Renton



Location: Ferndale and 7th St
Pipeline diameter: 10.75"
City Manhole ID: MH1360
Model Manhole ID:
Silt Level at Site: "

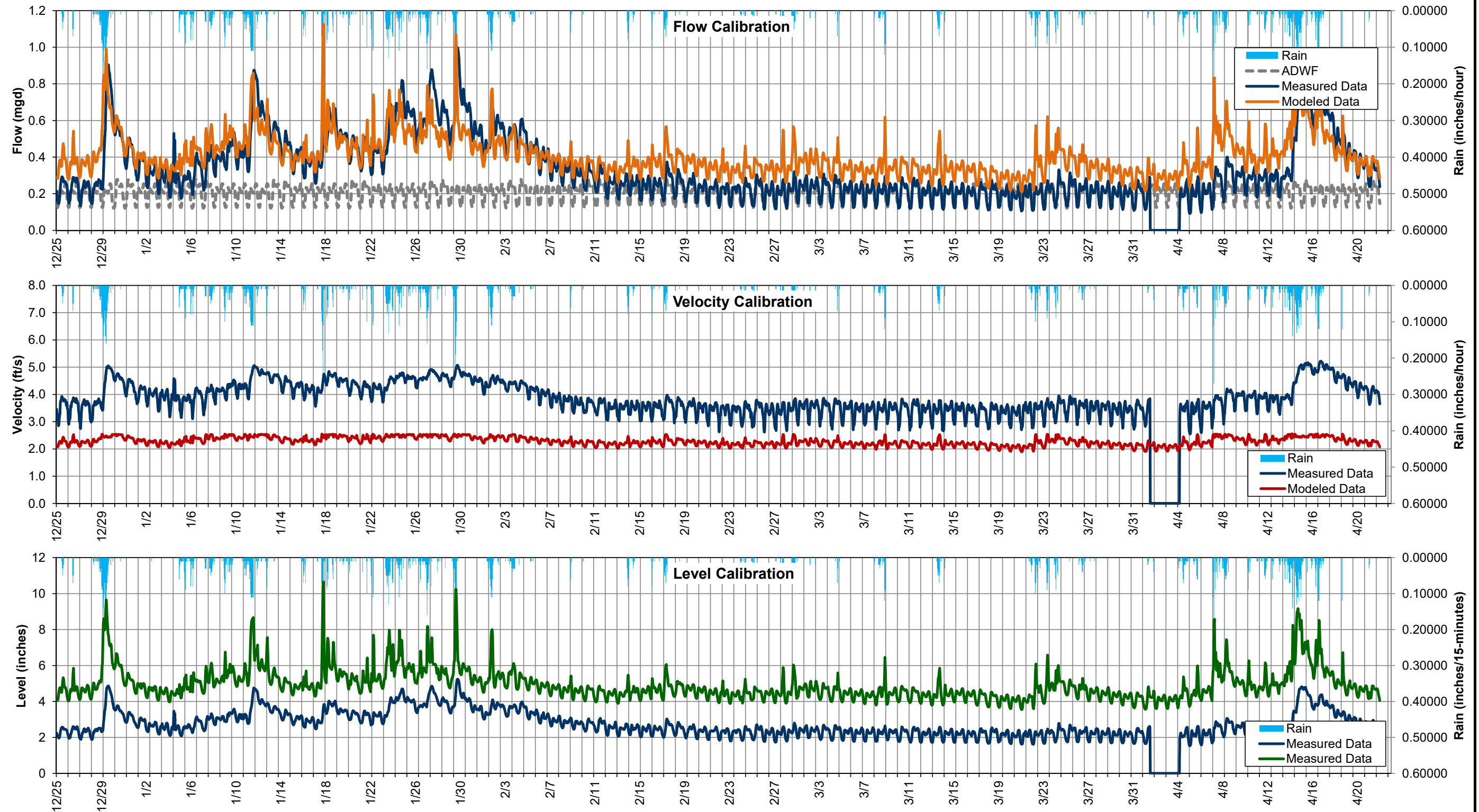



FLOW MONITORING MH1763 WET WEATHER FLOW CALIBRATION
Long-range Wastewater Management Plan
City of Renton



Location: 3000 SE th St
Pipeline diameter: 15"
City Manhole ID: MH1763
Model Mahhole ID:
Silt Level at Site: "

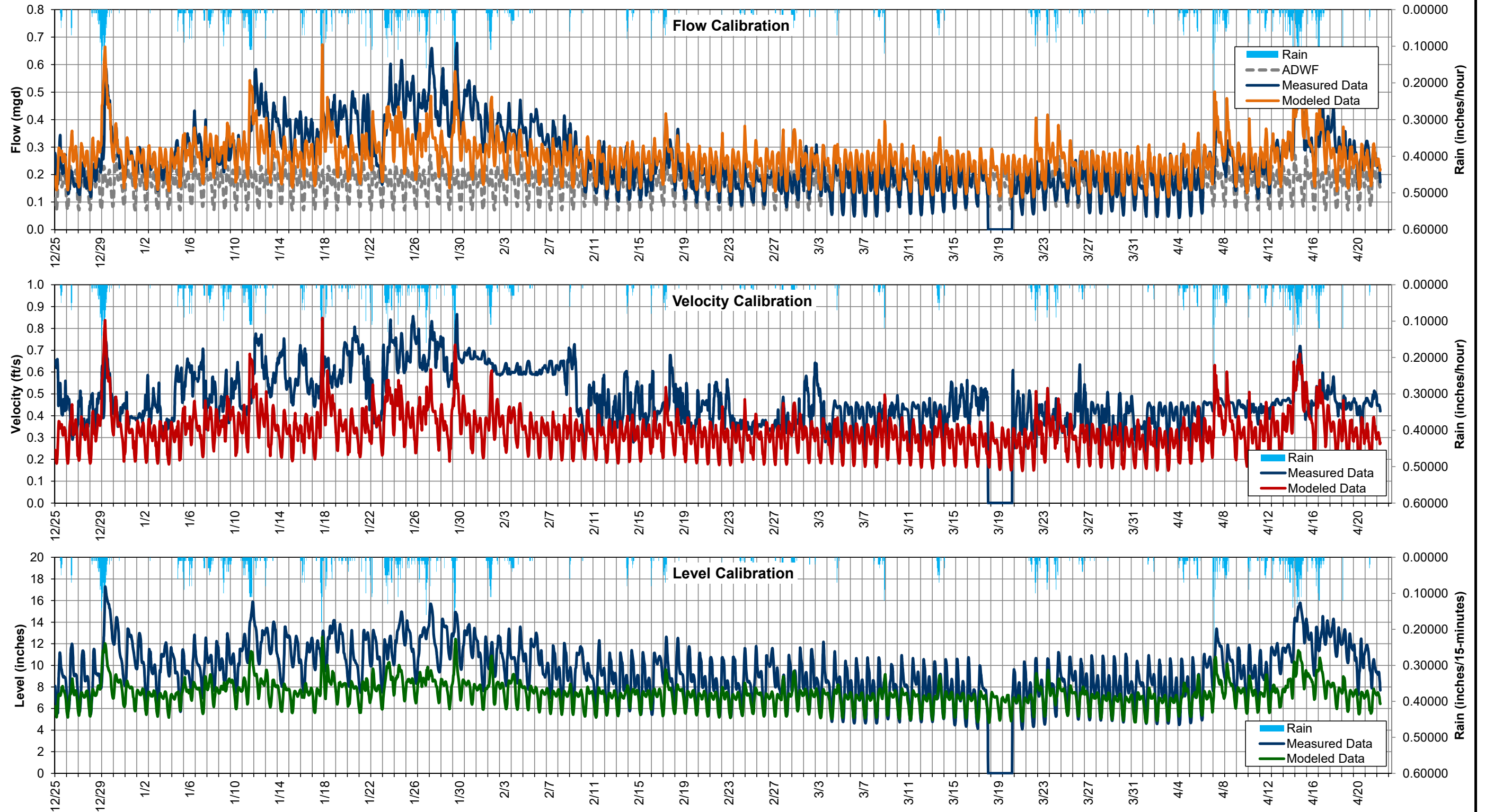



FLOW MONITORING MH2116 WET WEATHER FLOW CALIBRATION
Long-range Wastewater Management Plan
City of Renton



Location: Shattuck Ave and Tobin St
Pipeline diameter: 14.5"
City Manhole ID: MH2116
Model Manhole ID:
Silt Level at Site: "

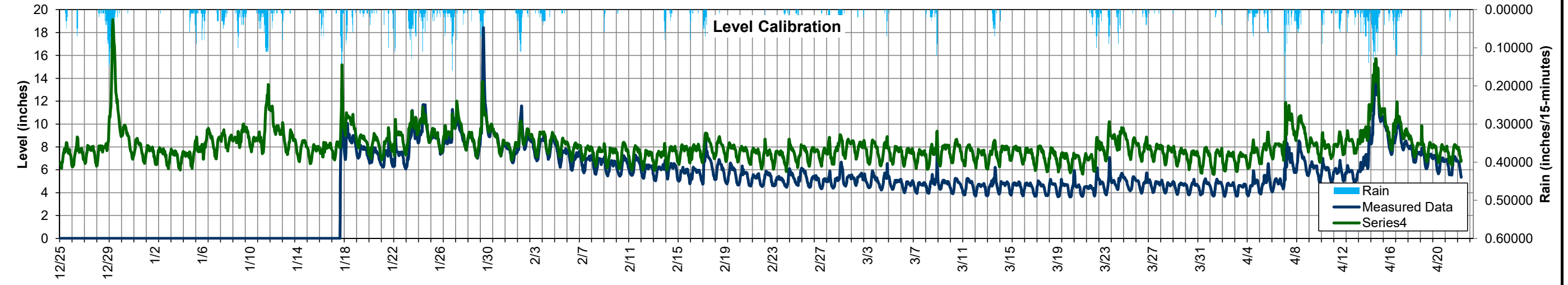
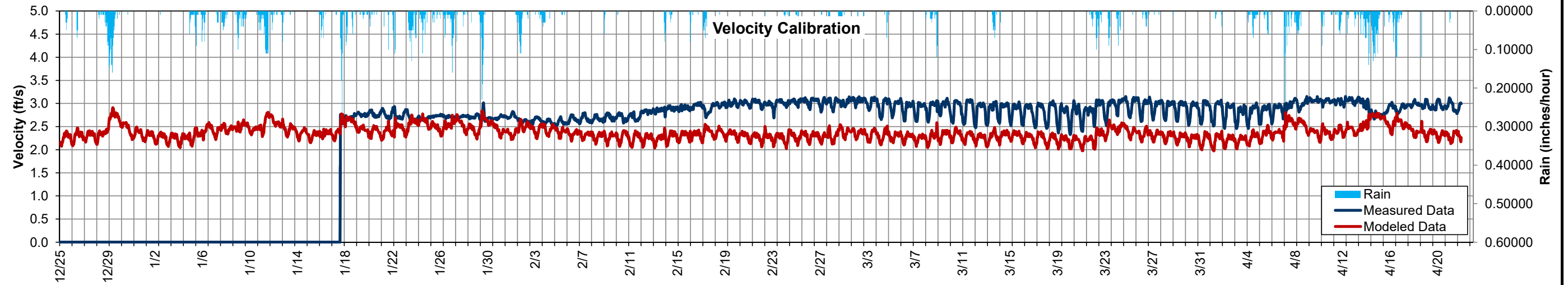
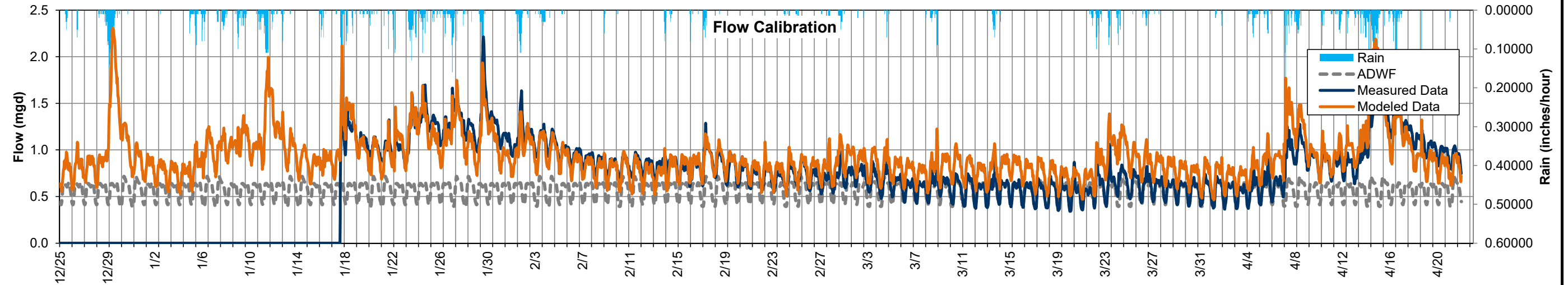



FLOW MONITORING MH2171 WET WEATHER FLOW CALIBRATION
Long-range Wastewater Management Plan
City of Renton



Location: 540 Burnett Ave S
Pipeline diameter: 11.25"
City Manhole ID: MH2171
Model Manhole ID:
Silt Level at Site: "

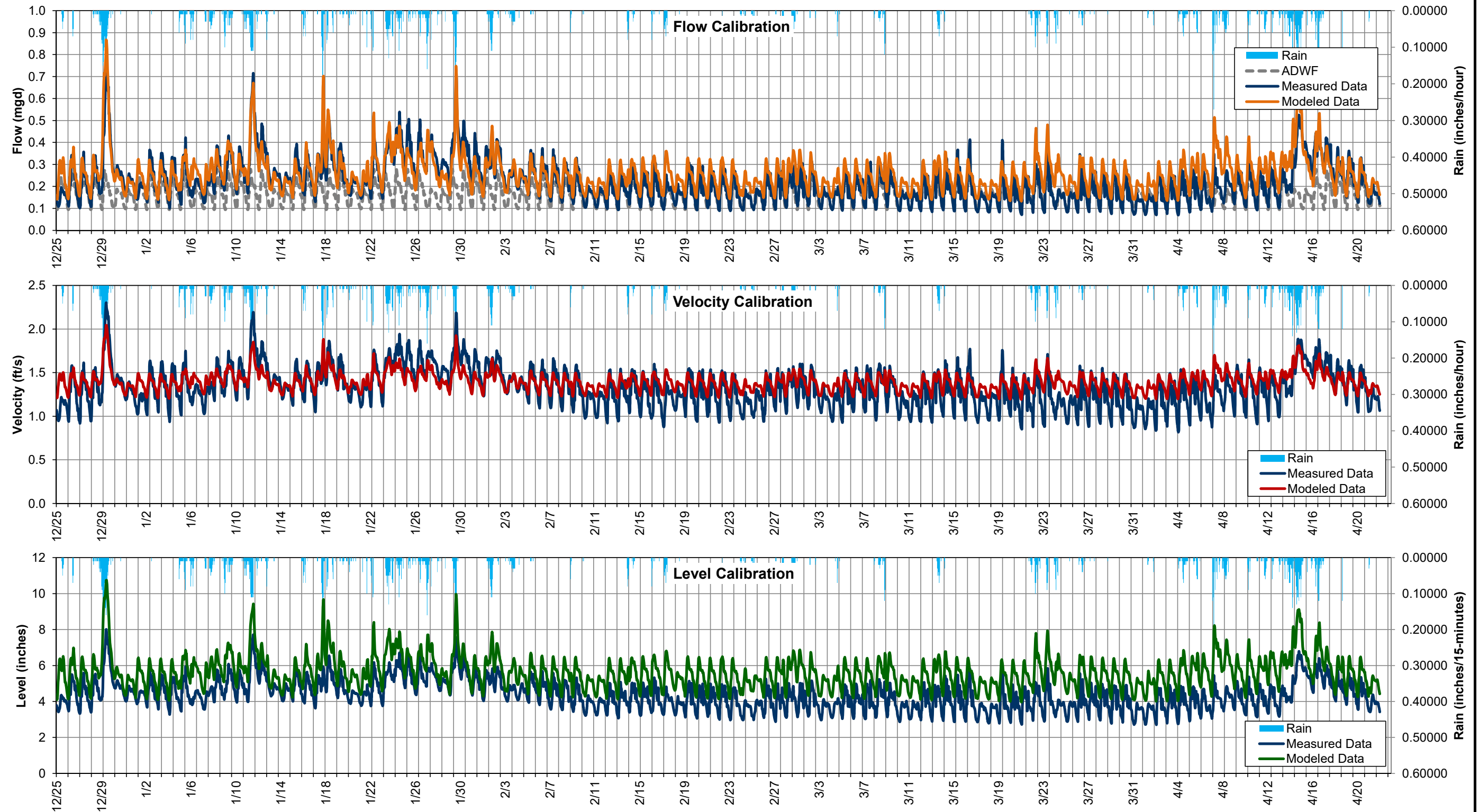



FLOW MONITORING MH2252 WET WEATHER FLOW CALIBRATION
Long-range Wastewater Management Plan
City of Renton



Location: Rainier and Grady Way
Pipeline diameter: 18"
City Manhole ID: MH2252
Model Manhole ID:
Silt Level at Site: "

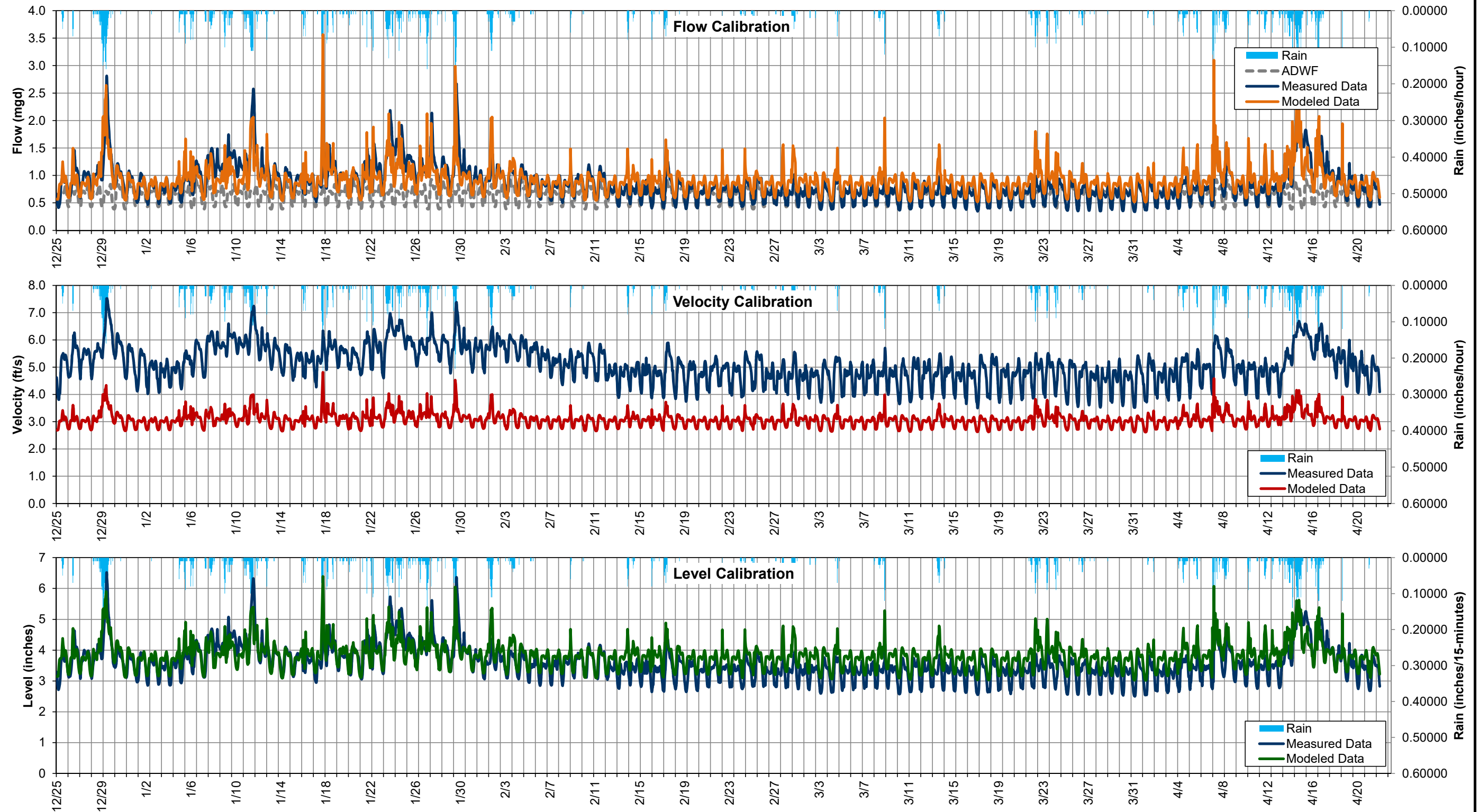



FLOW MONITORING MH2999 WET WEATHER FLOW CALIBRATION
Long-range Wastewater Management Plan
City of Renton



Location: 3431 Shattuck Ave S
Pipeline diameter: 8"
City Manhole ID: MH2999
Model Manhole ID:
Silt Level at Site: "

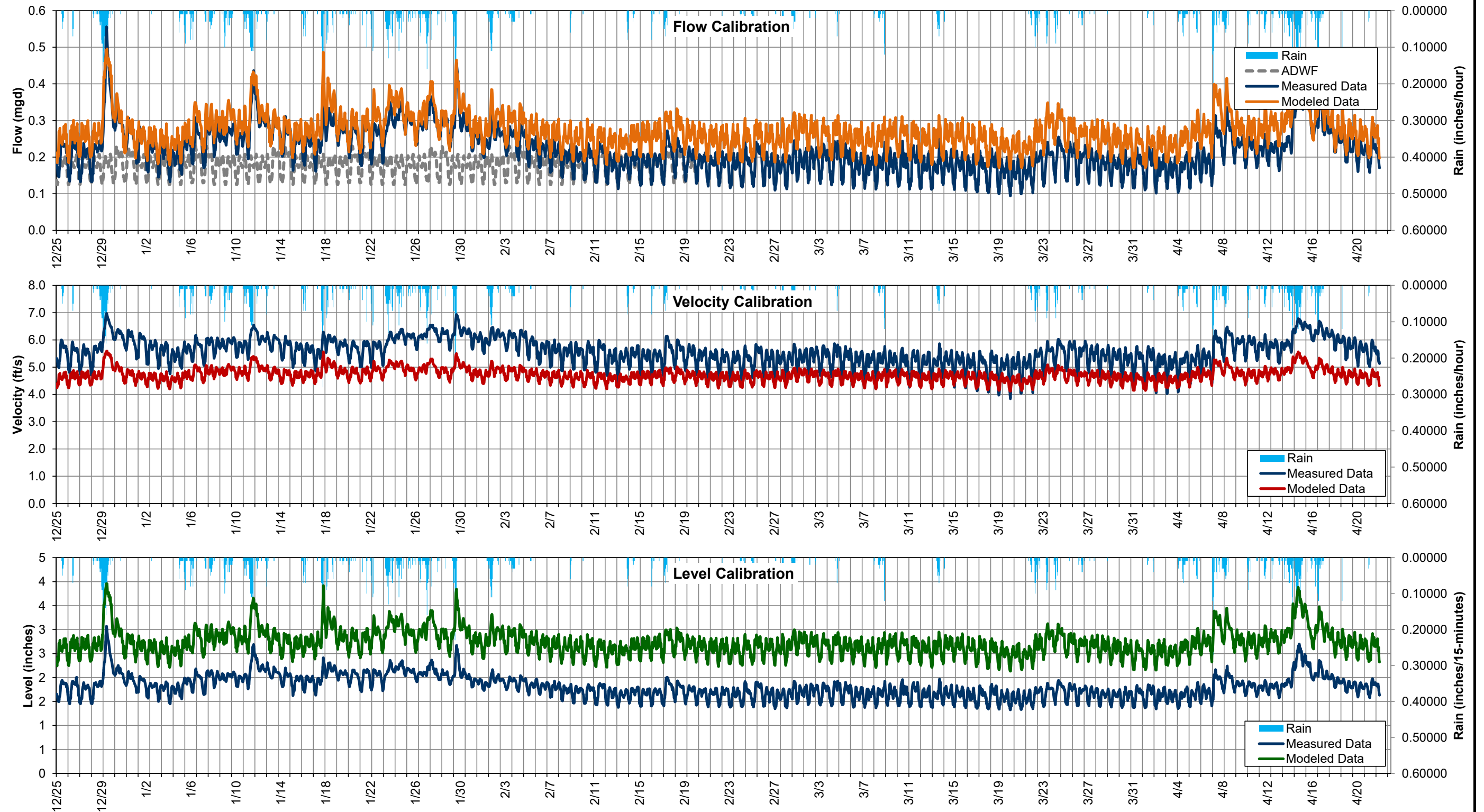



FLOW MONITORING MH3216 WET WEATHER FLOW CALIBRATION
Long-range Wastewater Management Plan
City of Renton



Location: West of 4022 Talbot Rd S
Pipeline diameter: 7.38"
City Manhole ID: MH3216
Model Manhole ID:
Silt Level at Site: "

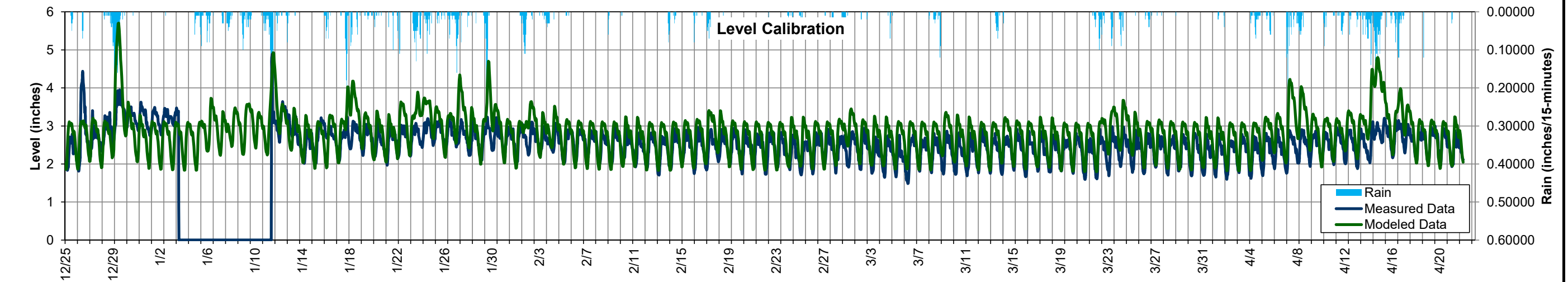
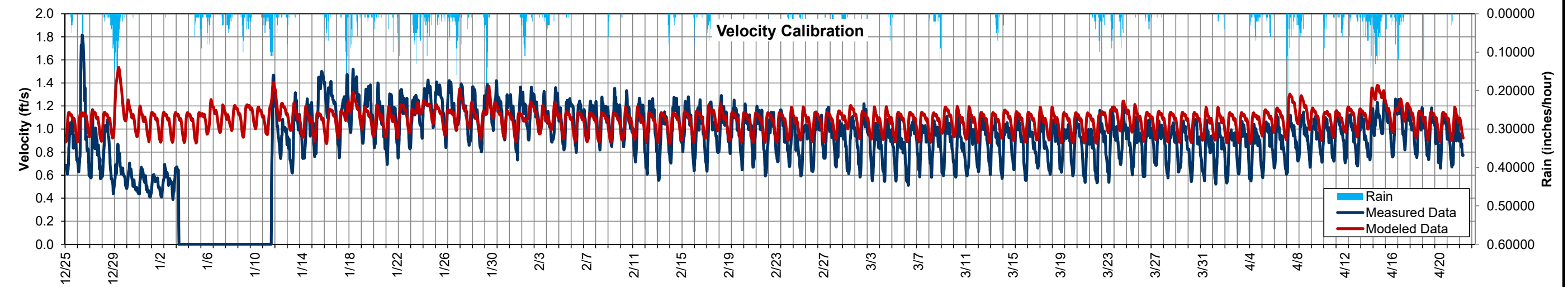
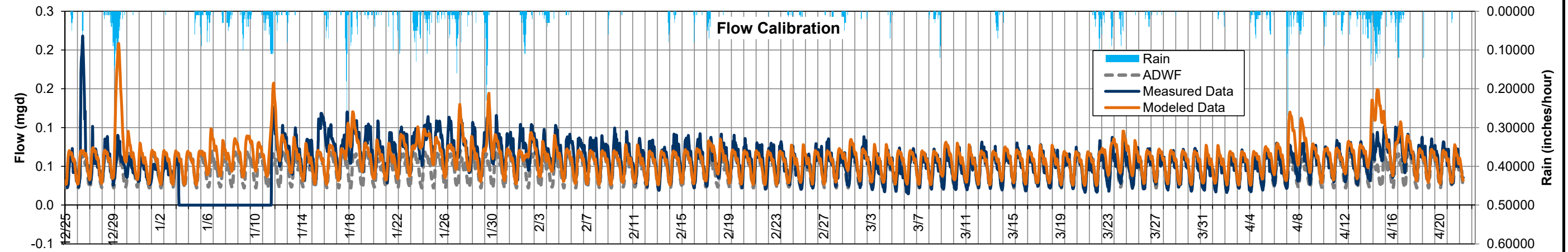



Location: 4201 NE Sunset Blvd
Pipeline diameter: 12"
City Manhole ID: MH3625
Model Manhole ID:
Silt Level at Site: "

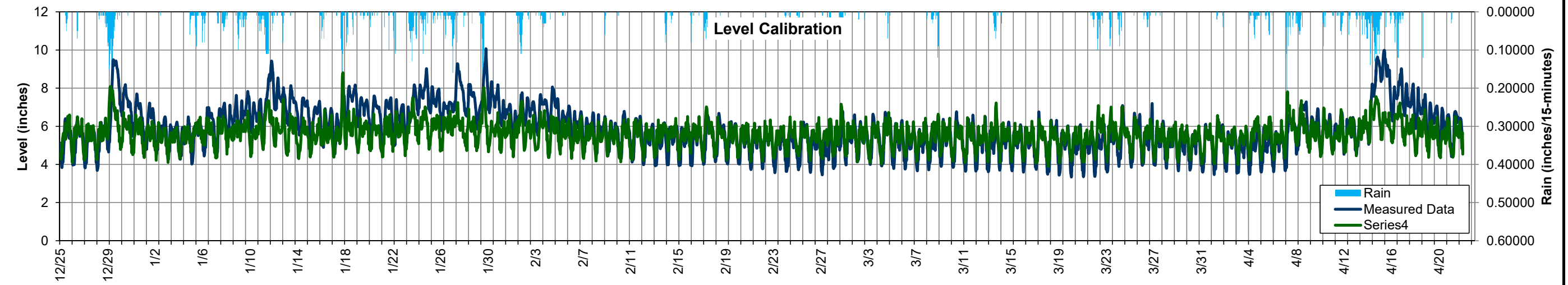
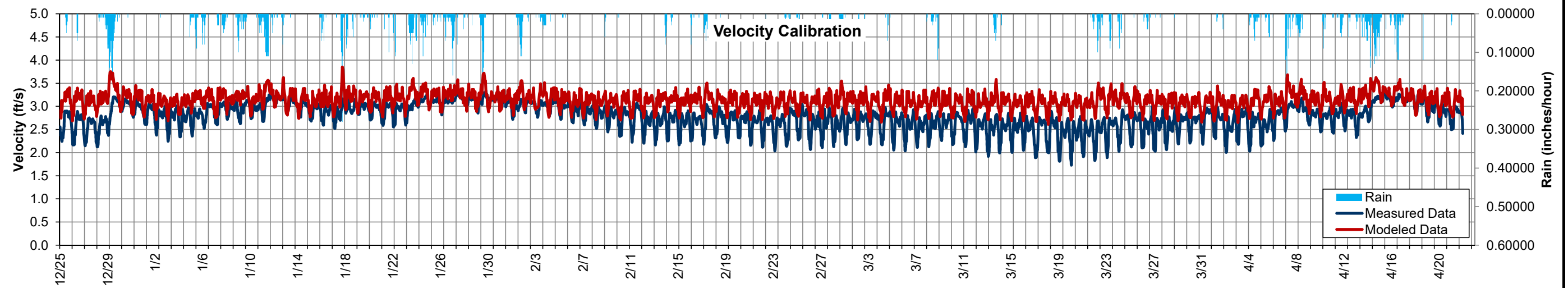
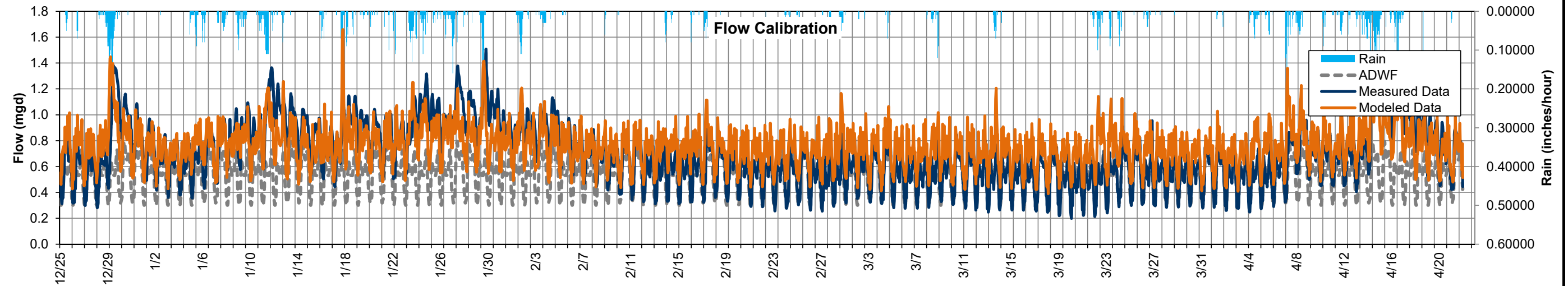



Location: 766 Monroe Ave NE
Pipeline diameter: 10.38"
City Manhole ID: MH4628
Model Manhole ID:
Silt Level at Site: "

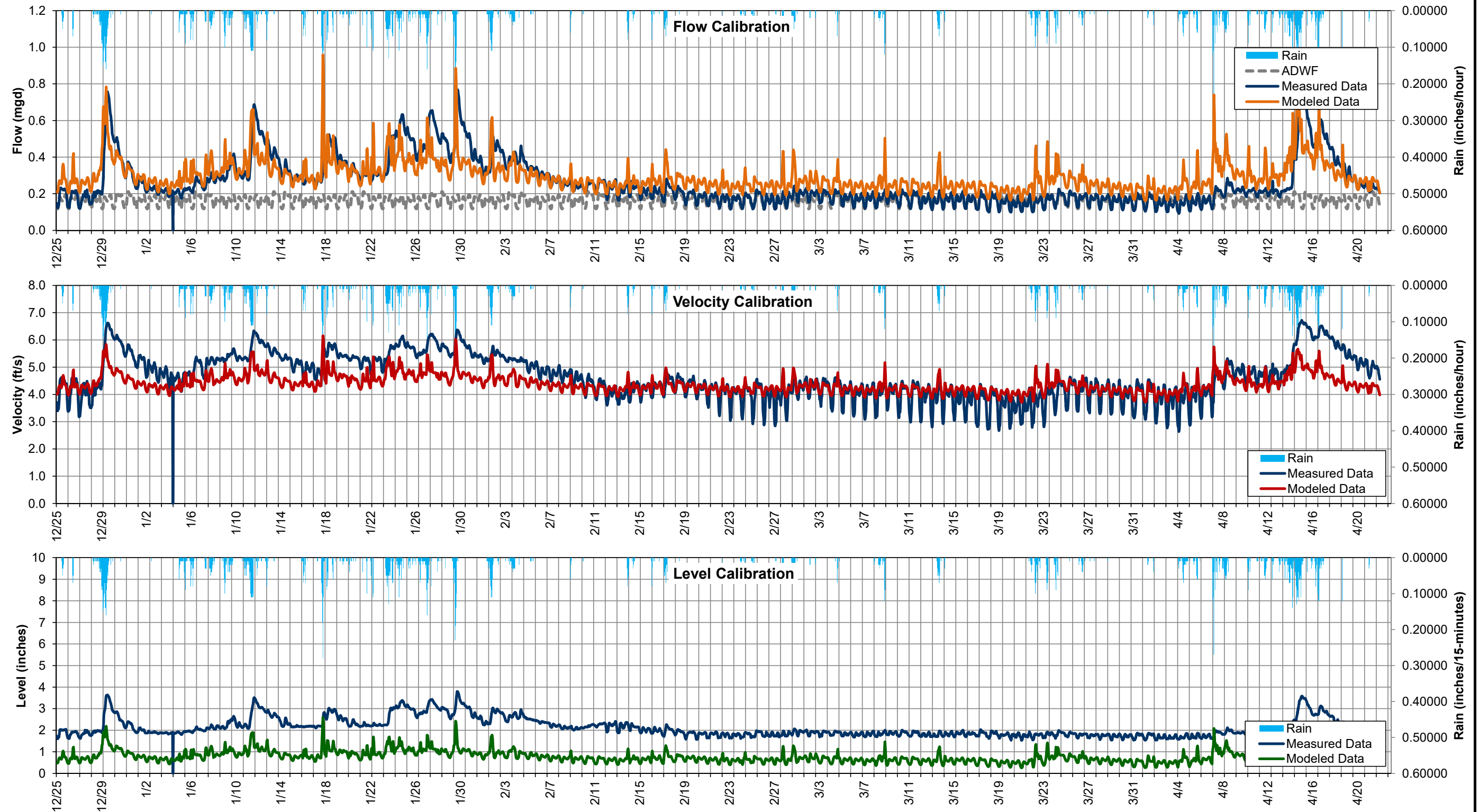



Location: 582 Bronson Way NE
Pipeline diameter: 8"
City Manhole ID: MH4646
Model Manhole ID:
Silt Level at Site: "

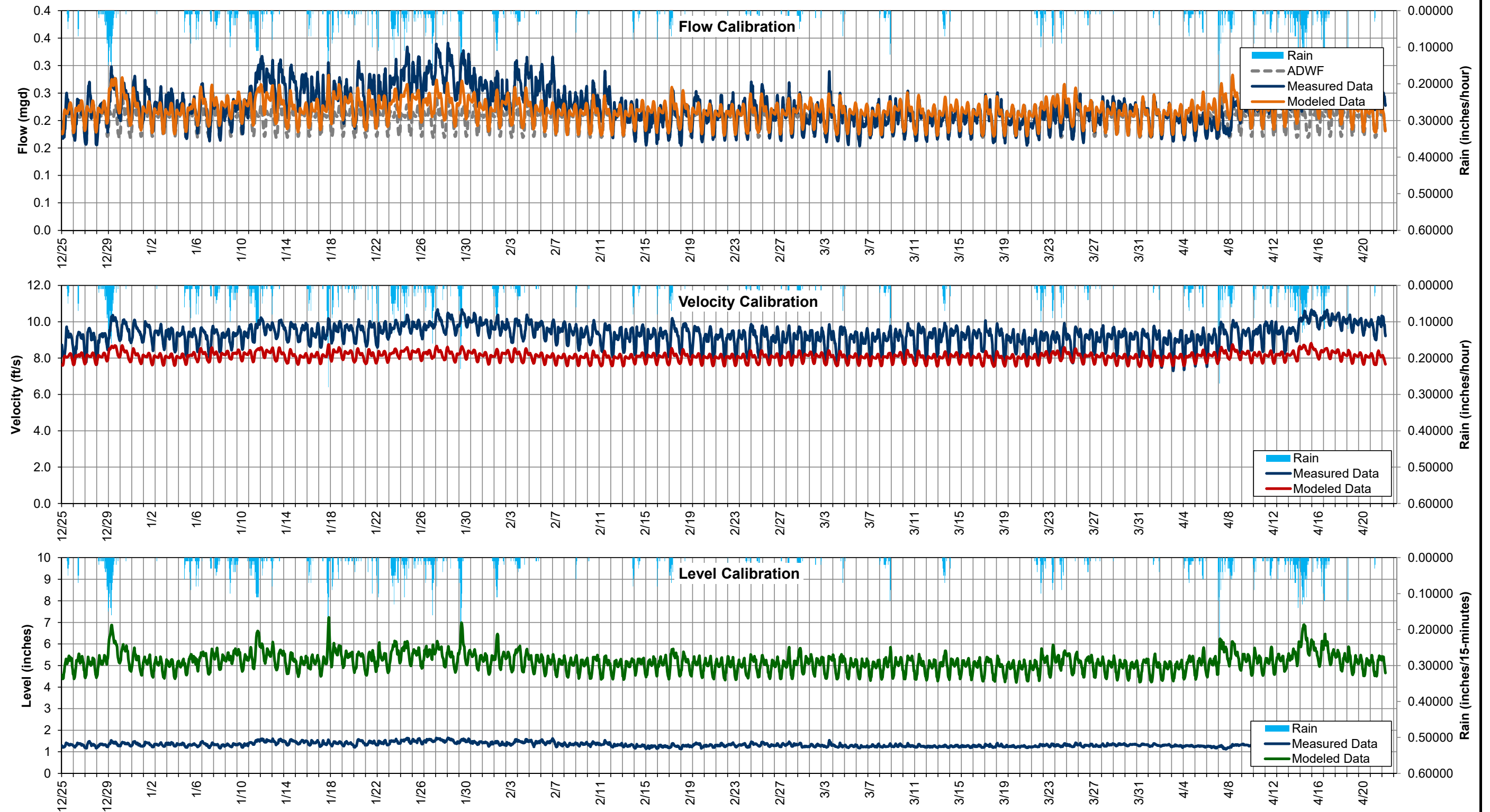



FLOW MONITORING MH5302 WET WEATHER FLOW CALIBRATION
Long-range Wastewater Management Plan
City of Renton



Location: Royal Hills and SE Harrington PI
Pipeline diameter: 14"
City Manhole ID: MH5302
Model Manhole ID:
Silt Level at Site: "

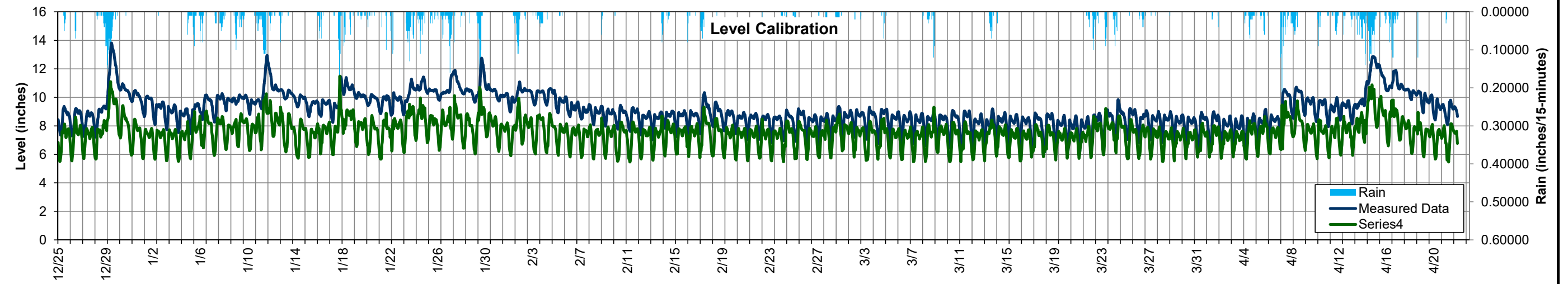
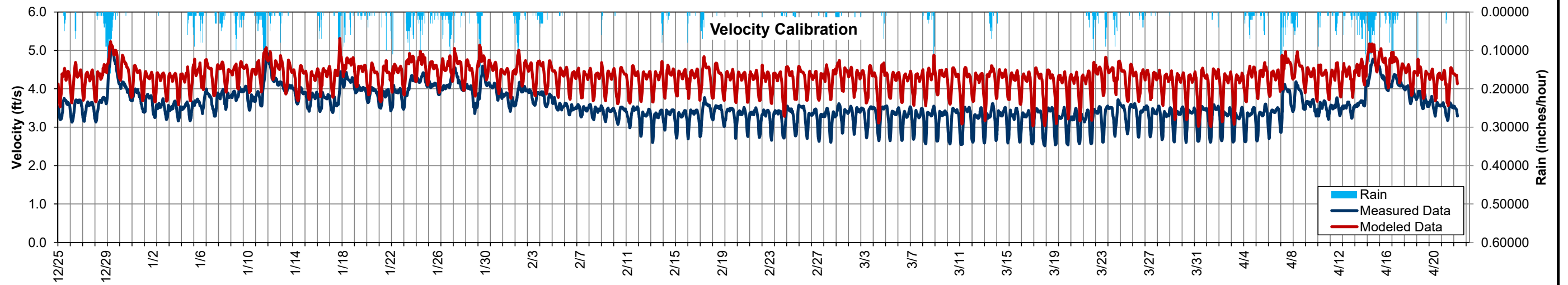
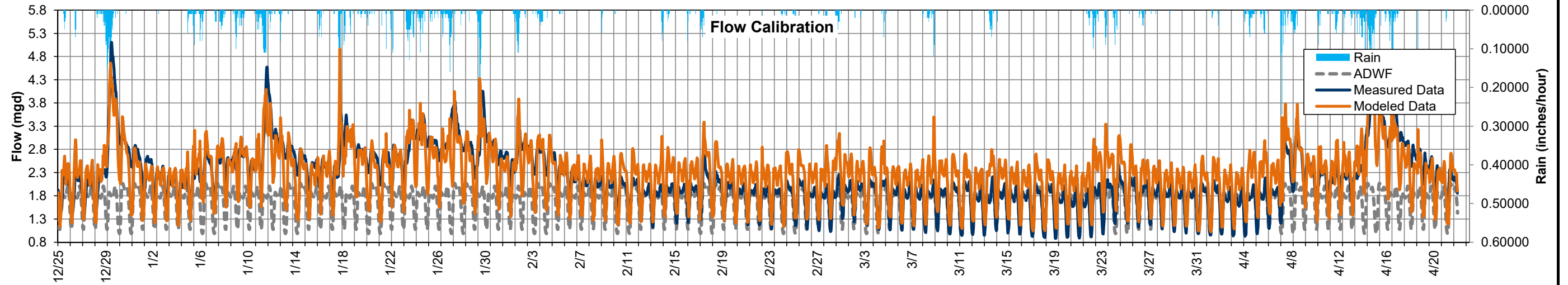



FLOW MONITORING MH5505 WET WEATHER FLOW CALIBRATION
Long-range Wastewater Management Plan
City of Renton



Location: 4444 NE Sunset Blvd
Pipeline diameter: 10"
City Manhole ID: MH5505
Model Manhole ID:
Silt Level at Site: "

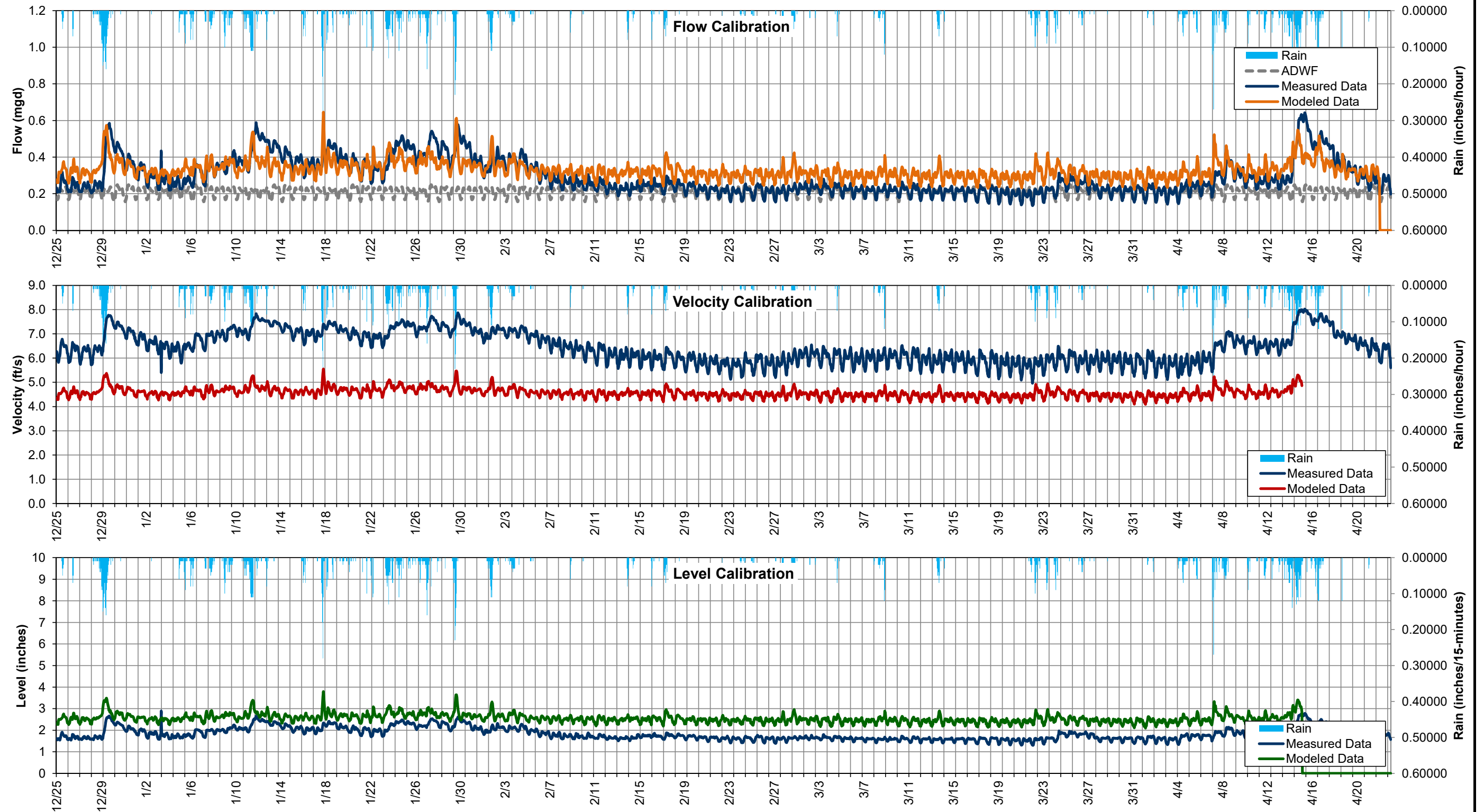



FLOW MONITORING MH5519 WET WEATHER FLOW CALIBRATION
Long-range Wastewater Management Plan
City of Renton



Location: Access via Talbot Rd S
Pipeline diameter: 10.25"
City Manhole ID: MH5519
Model Manhole ID:
Silt Level at Site: "

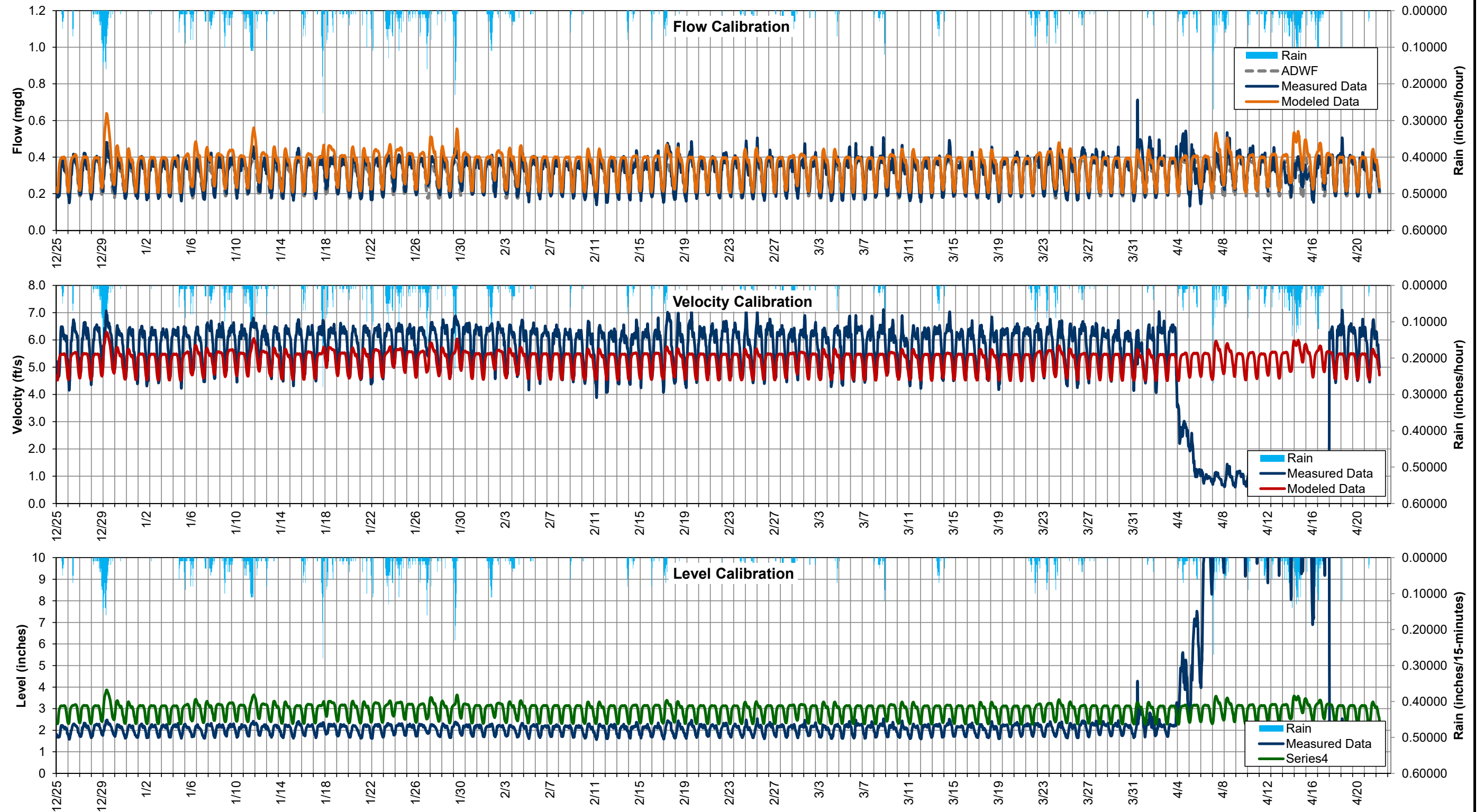



Location: Edmonds Ave and NE Sunset Blvd
Pipeline diameter: 8"
City Manhole ID: MH6041
Model Manhole ID:
Silt Level at Site: "

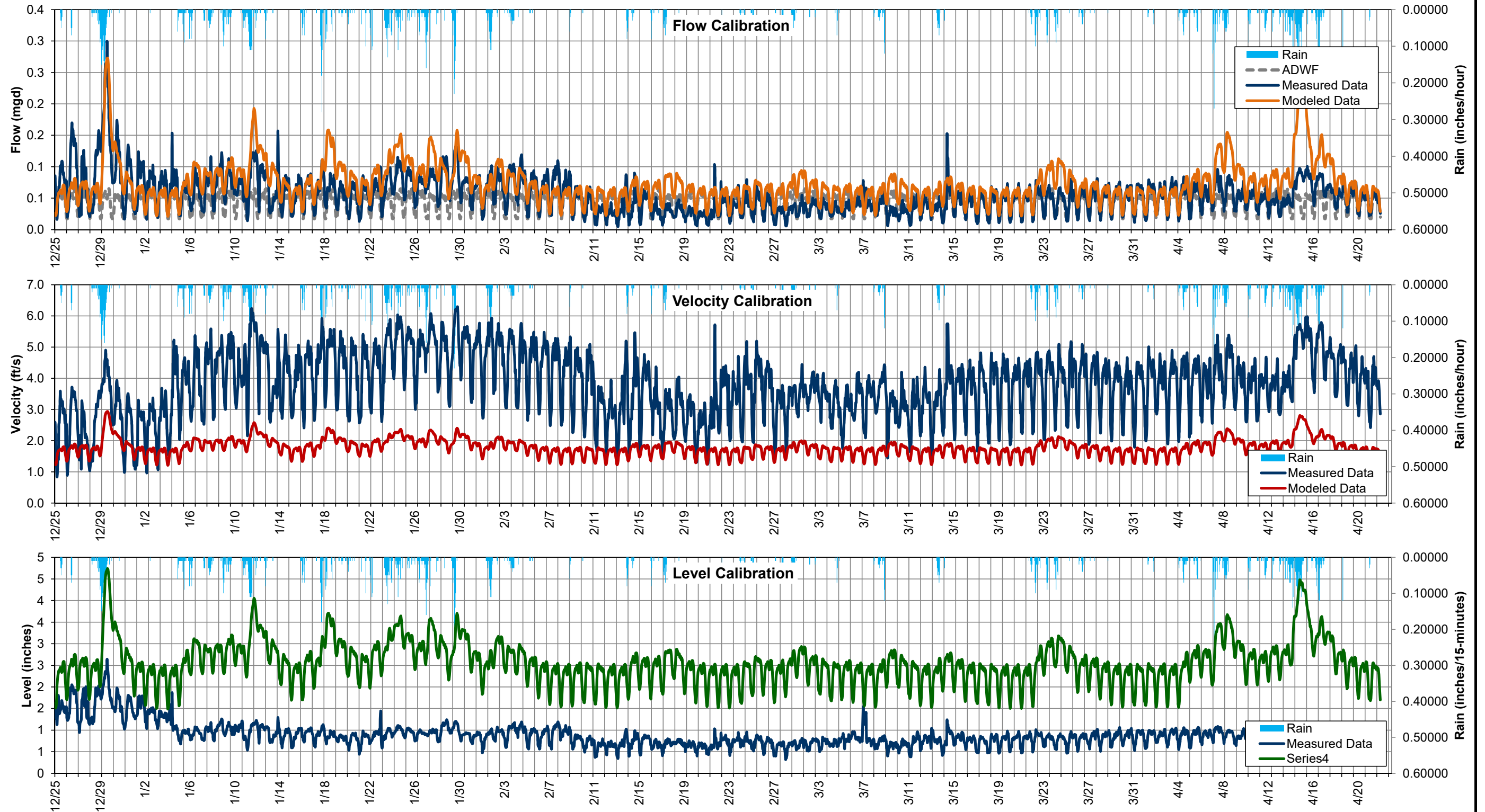



Location: 2623 NE Sunset Blvd
Pipeline diameter: 12"
City Manhole ID: MH6704
Model Manhole ID:
Silt Level at Site: "

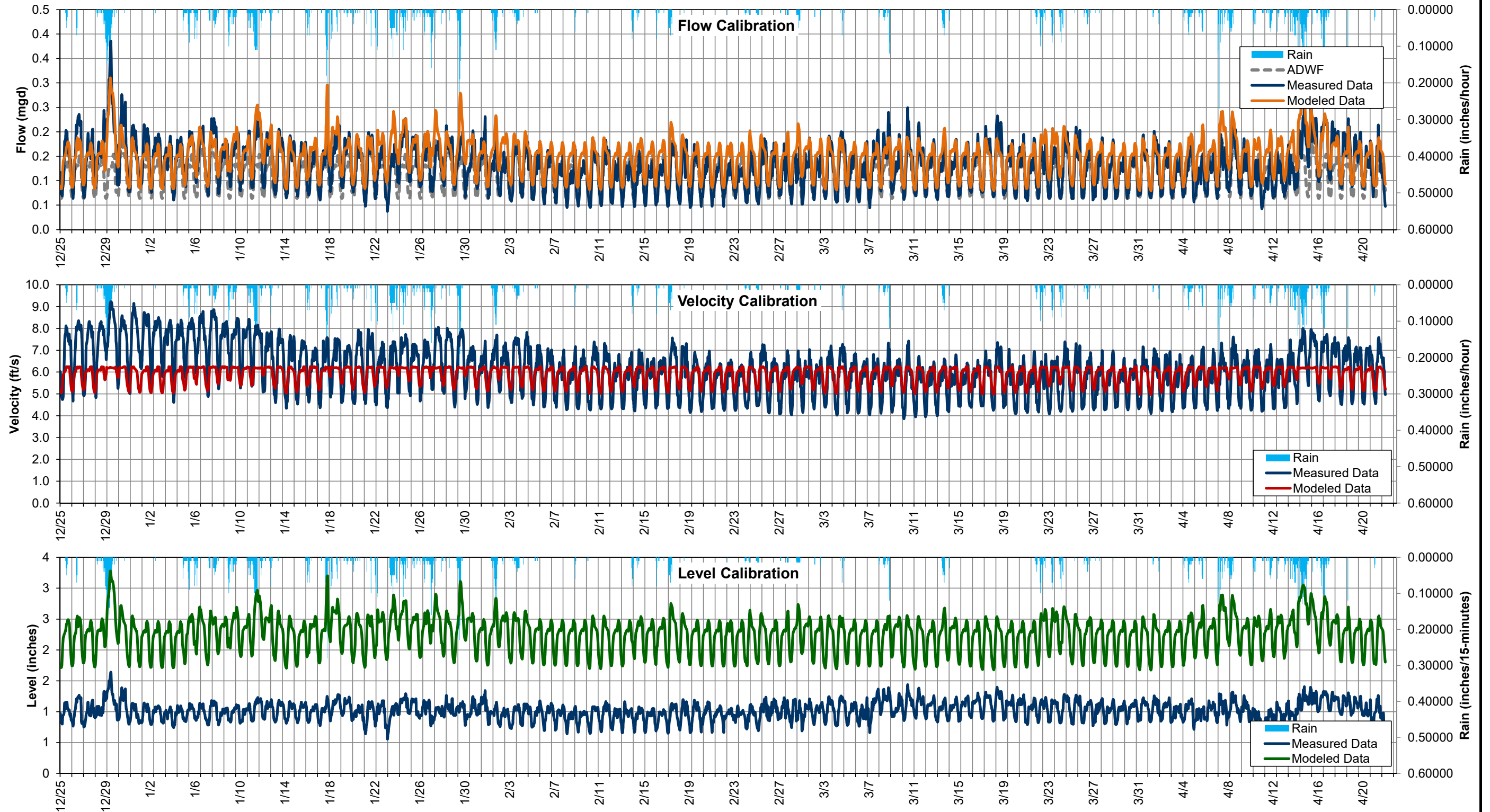

Appendix I
TM 4 - RISK FINDINGS



This document is released
for the purpose of
information exchange
review and planning only
under the authority of
Lara R. Kammereck,
June 16, 2017,
34428, WA.

CITY OF RENTON
LONG-RANGE WASTEWATER MANAGEMENT PLAN
TECHNICAL MEMORANDUM NO. 4
RISK FINDINGS
DRAFT
June 2017

CITY OF RENTON
LONG-RANGE WASTEWATER MANAGEMENT PLAN
TECHNICAL MEMORANDUM
NO. 4
RISK FINDINGS

TABLE OF CONTENTS

	<u>Page No.</u>
1.0 INTRODUCTION/METHODOLOGY.....	4-1
1.1 Methodology.....	4-1
2.0 CRITERIA.....	4-2
3.0 DATA SOURCES.....	4-6
4.0 SCORING.....	4-6
4.1 Vulnerability Score Range.....	4-6
4.2 Criticality Score Range.....	4-7
4.3 Risk Scoring.....	4-7
5.0 VULNERABILITY RESULTS.....	4-8
6.0 CRITICALITY RESULTS.....	4-23
7.0 RISK.....	4-41

LIST OF TABLES

Table 2.1 Vulnerability Criteria.....	4-3
Table 2.2 Criticality Criteria.....	4-4
Table 4.1 Vulnerability Score Range.....	4-6
Table 4.2 Criticality Score Range.....	4-7
Table 4.3 Normalized Risk Ratings.....	4-8
Table 5.1 Vulnerability Score by Length.....	4-8
Table 6.1 Criticality Score Range.....	4-23
Table 7.1 Normalized Risk Ratings.....	4-41
Table 7.2 Pipe Length Totals Based on Risk Rating.....	4-41

LIST OF FIGURES

Figure 5.1 Summary of Vulnerability Scoring.....	4-9
Figure 5.2 Structural Condition, CCTV Inspection Results.....	4-11
Figure 5.3 O&M Condition, CCTV Inspection Results.....	4-13
Figure 5.4 Remaining Useful Life Results.....	4-15
Figure 5.5 Frequency of Preventative Maintenance.....	4-17
Figure 5.6 Slope of Pipe Segment Results.....	4-19
Figure 5.7 Vulnerability Criteria Results.....	4-21

Figure 6.1	Summary of Criticality Rating and Scores	4-24
Figure 6.2	Cost to Repair Failure Results	4-25
Figure 6.3	Loss of Critical Infrastructure and Transportation Links Results	4-27
Figure 6.4	Damage to Property Results	4-29
Figure 6.5	Environmental Impacts Results.....	4-31
Figure 6.6	Loss of Service to Customers Results	4-33
Figure 6.7	Reputational Damage Results	4-35
Figure 6.8	Damage to Local Business and Economy Results	4-37
Figure 6.9	Criticality Criteria Results.....	4-39
Figure 7.1	Map of Criticality x Vulnerability	4-43

RISK FINDINGS

1.0 INTRODUCTION/METHODOLOGY

The City of Renton (City) requested Carollo Engineers, Inc. (Carollo) to develop a risk-based prioritization for their repair and replacement (R&R) projects in conjunction with implementation of Phase 2 of the City's closed-circuit television (CCTV) Implementation program. The City's risk based R&R program will be an important component meeting the City's goal to:

- Provide adequate, reliable sanitary sewer service at a minimum cost to the customer.

Risk of an asset (pipe, manhole, pump, etc.) is a measure of the impact of asset failure on the overall system. Risk is calculated as the product of criticality and vulnerability, or

$$\text{Risk} = \text{Criticality} \times \text{Vulnerability}$$

Criticality represents the consequence of failure, and the vulnerability represents the likelihood of failure. This assessment is at a conceptual planning level and does not include survey, site inspections, or other detailed investigations.

1.1 Methodology

A risk ranking was developed for all gravity collection pipelines in the system during the study. The vulnerability and criticality criteria, data sources, and levels were identified. Criteria were developed from the Halcrow Risk and Remaining Life Planning Tools (Weber Davis Aqueduct, March 2011), which was consistent with the City's prior risk based R&R prioritization of force mains (Existing Force Main Condition Assessment and Lift Station Evaluation, Carollo 2016). The Halcrow criteria were refined for meet the City's objectives and available data sources. Data sources and levels were chosen that represented the selected criteria, were readily available, and that could be applied consistently across the entire system.

Once the criteria and data sources were set, each pipe segment was assigned a score based criteria ratings in GIS. The levels varied from negligible criticality or vulnerability (Level 1) to severe (Level 4). The levels are represented numerically as 1 to 4. Weighted factors were applied to reflect the City's priorities. The pipe segments' weight for each criteria were then summed to find a final vulnerability and criticality score for that segment. Those two scores were then combined into 16 different "criticality, vulnerability" combinations (for example, 1,2; 2,3; or 4,4), and each combination was categorized with a risk ranking of low, moderately-low, moderately-high, and high.

2.0 CRITERIA

Tables 2.1 and 2.2 show the criteria, weighting, and description of each level for vulnerability and criticality, respectively. These criteria and data sources reflect an iterative refinement process that reflected the City's typical key decision factors and the perceived accuracy of the data. Where the decision factors or available data did not support four levels of scoring two levels of scoring were typically used. For example, the criticality criterion for environmental impacts receives a level of 3 when within 50 feet from a critical area and a level of 1 at greater distances. Given the high level of the critical area data, the City was not comfortable in differentiating the criteria further without a site-specific investigation (wetland delineation, geotechnical analysis, etc.). These site-specific analyses are generally conducted as part of the design of the R&R project and could not be reasonably completed City wide.

A total score was calculated for each criteria for all gravity collection pipes in the system. For example, if a pipe segment's remaining useful life (RUL) was between five and ten years, the segment would fall into the Vulnerability Level 3, or moderate, rating. Multiplying the level of three (3) by an RUL weight of one (1), the final weighed level for that criteria would be $3 \times 1 = 3$. The same calculation would be made for the remaining criteria and summed for an overall score. To aid in review, a consistent color scheme is applied to the levels and scores in all mapping. Additionally, a code was given for each criteria for simplicity when identifying the criteria on the figures later in this Technical Memo (TM).

Table 2.1 Vulnerability Criteria Long-Range Wastewater Management Plan City of Renton						
Criteria	Code	Weighting	Level 1	Level 2	Level 3	Level 4
Structural Condition, CCTV Inspection Results	CCTV STRUCTURAL	1	<u>Negligible</u> Pipe not yet inspected: material is PVC or DIP Structural NASSCO Score ≤ 2	<u>Low</u> Pipe not yet inspected: all other materials Structural NASSCO Score > 2 and ≤ 3	<u>Moderate</u> Structural NASSCO Score > 3 and ≤ 4	<u>Severe</u> Structural NASSCO Score > 4
O&M Condition, CCTV Inspection Results	CCTV OM	1	<u>Negligible</u> Pipe not yet inspected: material is PVC or DIP O&M NASSCO Score ≤ 2	<u>Low</u> Pipe not yet inspected: all other materials O&M NASSCO Score > 2 and ≤ 3	<u>Moderate</u> O&M NASSCO Score > 3 and ≤ 4	<u>Severe</u> O&M NASSCO Score > 4
Remaining Useful Life Estimate	RUL	1	<u>Negligible</u> RUL > 20 years	<u>Low</u> RUL between 10 and 20 years	<u>Moderate</u> RUL between 5 and 10 years	<u>Severe</u> Less than 5 years RUL
Frequency of Preventative Maintenance	MAINT	1	<u>Negligible</u> No Cleaning	<u>Low</u> Annual OR Biannual Cleaning	<u>Moderate</u> Monthly or Quarterly Cleaning	<u>Severe</u> Biweekly or Weekly Cleaning
Slope of Pipe Segment	SLOPE	1	<u>Negligible</u> Slope $> 0.5\%$	<u>Low</u> Slope $\leq 0.5\%$	<u>Moderate</u>	<u>Severe</u>

Table 2.2 Criticality Criteria Long-Range Wastewater Management Plan City of Renton						
Criteria	Code	Weighting	Level 1	Level 2	Level 3	Level 4
Cost to Repair Failure	REPAIR	1	<u>Small Repair Effort by City Crew</u> Pipe Diameter: ≤ 12" AND Pipe Depth: <12'	<u>Large Repair Effort by City Crew</u> Pipe Diameter: > 12" AND Pipe Depth: <12'	<u>Small Repair Effort by Contractor</u> Pipe Diameter: ≤ 12" AND Pipe Depth: ≥12'	<u>Large Repair Effort by Contractor</u> Pipe Diameter: > 12" AND Pipe Depth: ≥12'
Loss of Critical Infrastructure and Transportation Links	TRANS	2	<u>Negligible</u> No Site of Interest OR Non-arterials	<u>Low</u> No Site of Interest OR Collector Street	<u>Moderate</u> Site of Interest OR Arterial Street	<u>Severe</u> Critical Infrastructure OR Freeways
Damage to Property	PROP	1	<u>Negligible</u> Distance to Building Footprint - > 10 ft		<u>Moderate</u> Distance to Building Footprint ≤ 10 ft	
Environmental Impacts to waterway, wetland, or other Sensitive Area	ENV	1	<u>Negligible</u> Distance from Critical Area > 50 ft		<u>Moderate</u> Distance to Critical Area < 50 ft	
Loss of Service to Customers	LOS	1	<u>Negligible</u> Collection Line		<u>Moderate</u> Trunk Line	
Reputational Damage	REP	1	<u>Negligible</u> Outside Wellfield Capture Zone OR	<u>Low</u>	<u>Moderate</u>	<u>Severe</u> Within 200 ft. of Wellfield OR

Table 2.2 Criticality Criteria Long-Range Wastewater Management Plan City of Renton						
Criteria	Code	Weighting	Level 1	Level 2	Level 3	Level 4
			Distance to Critical Water Body >200 ft	Within 5 year Wellfield Capture Zone OR 2. Distance to Critical Water Body > 100 ft and ≤ 200 ft	Within 1 year Wellfield Capture Zone OR 2. Distance to Critical Water Body > 50 ft and ≤ 100 ft	<u>Distance to Critical Water Body <50 ft</u>
Damage to Local Business and Economy	BIZ	1	<u>Negligible Pipeline outside of Overlay District</u>		<u>Moderate Pipeline within Overlay District</u>	

3.0 DATA SOURCES

Data sources were largely available for the majority of the gravity collection system. Where data was missing (typically less than 2 percent of records), a Level 1 designation was assigned, except for CCTV criteria. The majority of the system has not undergone National Association of Sewer Services Companies (NASSCO) based CCTV inspections; therefore data is limited. Based on the NASSCO based CCTV inspections completed to date, pipes without data were rated based on material.

A detailed list of the data sources used for this technical memo can be found in the Pipe Risk Calculation technical memo.

4.0 SCORING

The following section shows the three types of scoring used to find the risk ranking. A detailed description of the scoring and how it was implemented can be found in the Pipe Risk Calculation technical memo.

4.1 Vulnerability Score Range

Weighted vulnerability levels for each pipe segment were summed up to find a total score for that pipe. For the force main risk assessment, vulnerability scores were separated into four levels, roughly equal to each other. For this study, scores were instead selected based on point ratings for specific conditions. Pipes with a criterion at a Level 3 or 4 received a vulnerability score of 3. Pipes with multiple of Level 3 and 4 criteria received a vulnerability score of 4. The adjusted scores are shown in the Table 4.1.

Table 4.1 Vulnerability Score Range Long-Range Wastewater Management Plan City of Renton		
Vulnerability Level	Minimum Score	Maximum Score
1 (negligible)	5	5
2 (low)	6	6
3 (moderate)	7	9
4 (severe)	10	16

4.2 Criticality Score Range

Similar to the vulnerability score range, the criticality ranges were selected point ratings based on specific conditions and shown in Table 4.2.

The minimum criticality score any pipe can receive is an 8, which would be the minimum scores for each criteria and assigned a criticality level of 1. Pipes with two Level 3 criteria result in a score in the Level 3 Criticality range. Multiple Level 3 and 4 criteria ratings result in a score in the Level 4 Criticality range. The rest of the levels are also shown in Table 4.2.

Table 4.2 Criticality Score Range Long-Range Wastewater Management Plan City of Renton		
Criticality Level	Minimum Score	Maximum Score
1 (negligible)	8	8
2 (low)	9	10
3 (moderate)	11	15
4 (severe)	16	23

4.3 Risk Scoring

The criticality, vulnerability, and risk ranking for each collection main were quantified in a relative risk scale, with one representing the lowest risk and four representing the highest risk. Table 4.3 below shows how the risk rating is scored based on the criticality and vulnerability scores.

It is recommended that the City implement the following actions based on the risk ranking the pipes receive:

- High Risk pipes should be prioritized for R&R. More frequent monitoring and/or preventative maintenance is recommended for these pipes until they are repaired or replaced.
- Moderately high risk pipes should be frequently monitored.
- Moderately low risk pipes should be monitored on a bi-monthly basis.
- Low risk pipe are typically monitored on a yearly basis.

Table 4.3 Normalized Risk Ratings Long-Range Wastewater Management Plan City of Renton					
Normalized Risk Ranking					
Vulnerability Level	4 (severe)	Moderately Low	Moderately High	High	High
	3 (moderate)	Moderately Low	Moderately High	Moderately High	High
	2 (low)	Low	Moderately Low	Moderately High	Moderately High
	1 (negligible)	Low	Low	Moderately Low	Moderately Low
		1 (negligible)	2 (low)	3 (moderate)	4 (severe)
		Criticality Level			

5.0 VULNERABILITY RESULTS

Table 5.1 shows the amount of pipe found in each vulnerability level. Approximately 45 percent of the City's system is considered a negligible vulnerability. Pipes having a low and moderate vulnerability make up approximately 14 and 31 percent of the system, respectfully. The City has approximately 10 percent of their system in the severe vulnerability.

Table 5.1 Vulnerability Score by Length Long-Range Wastewater Management Plan City of Renton		
Vulnerability Level	Length (feet)	Percent
1 (negligible)	589,783	45%
2 (low)	180,580	14%
3 (moderate)	397,772	31%
4 (severe)	<u>133,099</u>	<u>10%</u>
Total:	1,301,234	100%

Figure 5.1 shows the summary of the four vulnerability criteria given the rating. In general, each criteria increases as the level increases. The remaining useful life (RUL) criteria shows the most change as the level increases.

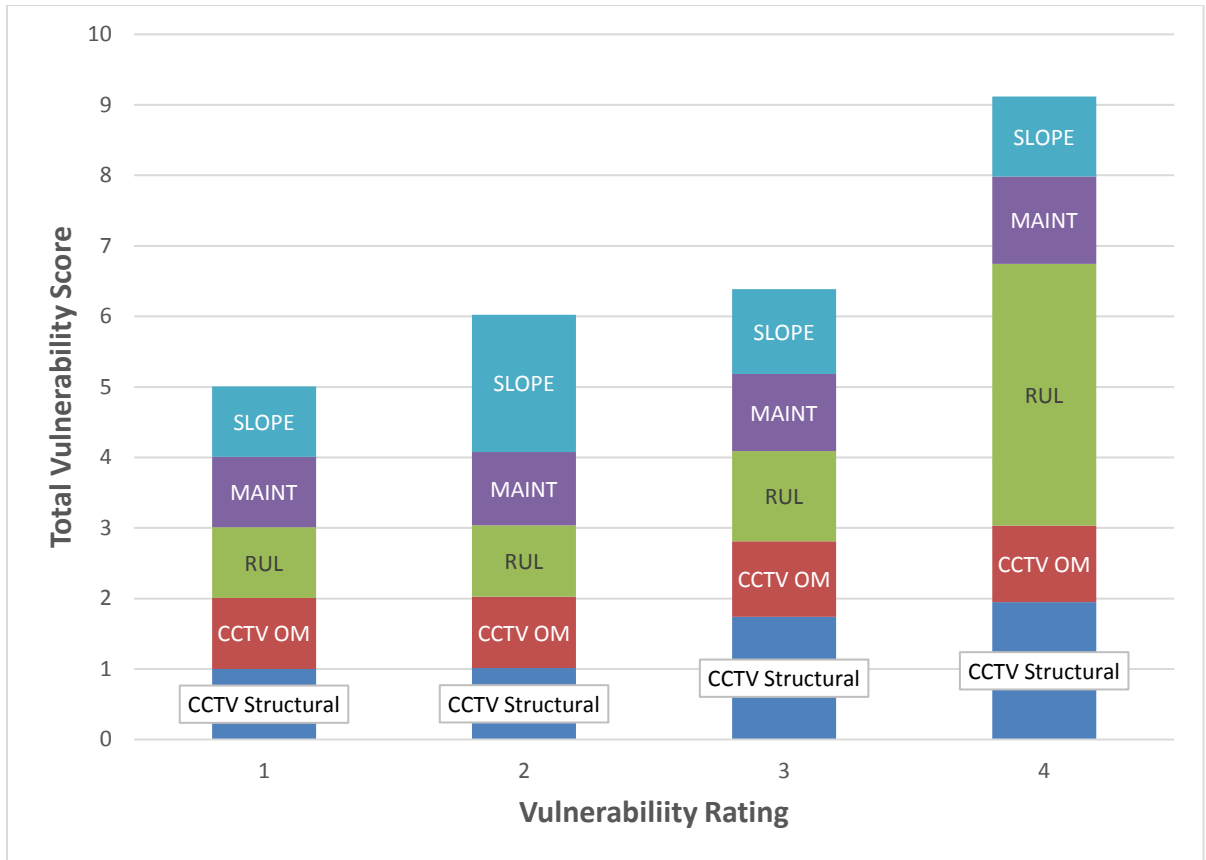

Figure 5.1 Summary of Vulnerability Scoring

The results of the vulnerability scores for each criteria are shown in Figures 5.2 through 5.7. The levels for each criteria are typically identified by the following colors:

- Red = Level 4 (severe)
- Orange = Level 3 (moderate)
- Dark Green = Level 2 (low)
- Light Green = Level 1 (negligible)

Showing the individual criteria on a map of the City's system gives the City a clear snapshot of where the current problem areas are located and what potential problem areas could occur if not monitored. For example, Figure 5.4 shows a large area of red pipe that have a vulnerability level of 4, or severe. This would indicate that most of this area has pipe with an RUL of less than five years, and should be reviewed for possible R&R in the near future.

Figure 5.7 shows the overall vulnerability scores. A large portion of moderate to severe pipe is located in the northern part of the City, east of the interstate. This is mainly due to the RUL of the pipe, and some pipe requiring periodic cleaning.

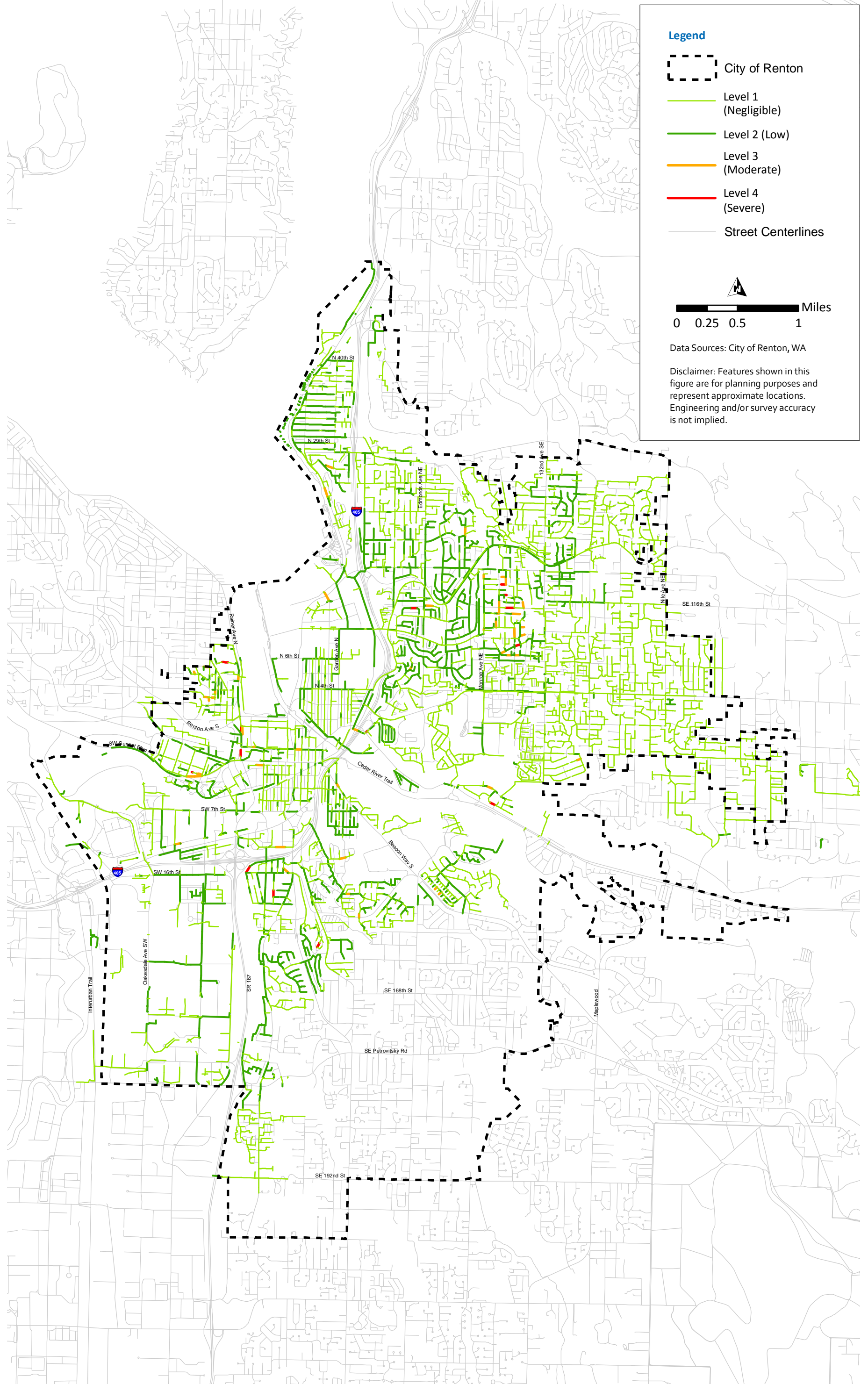

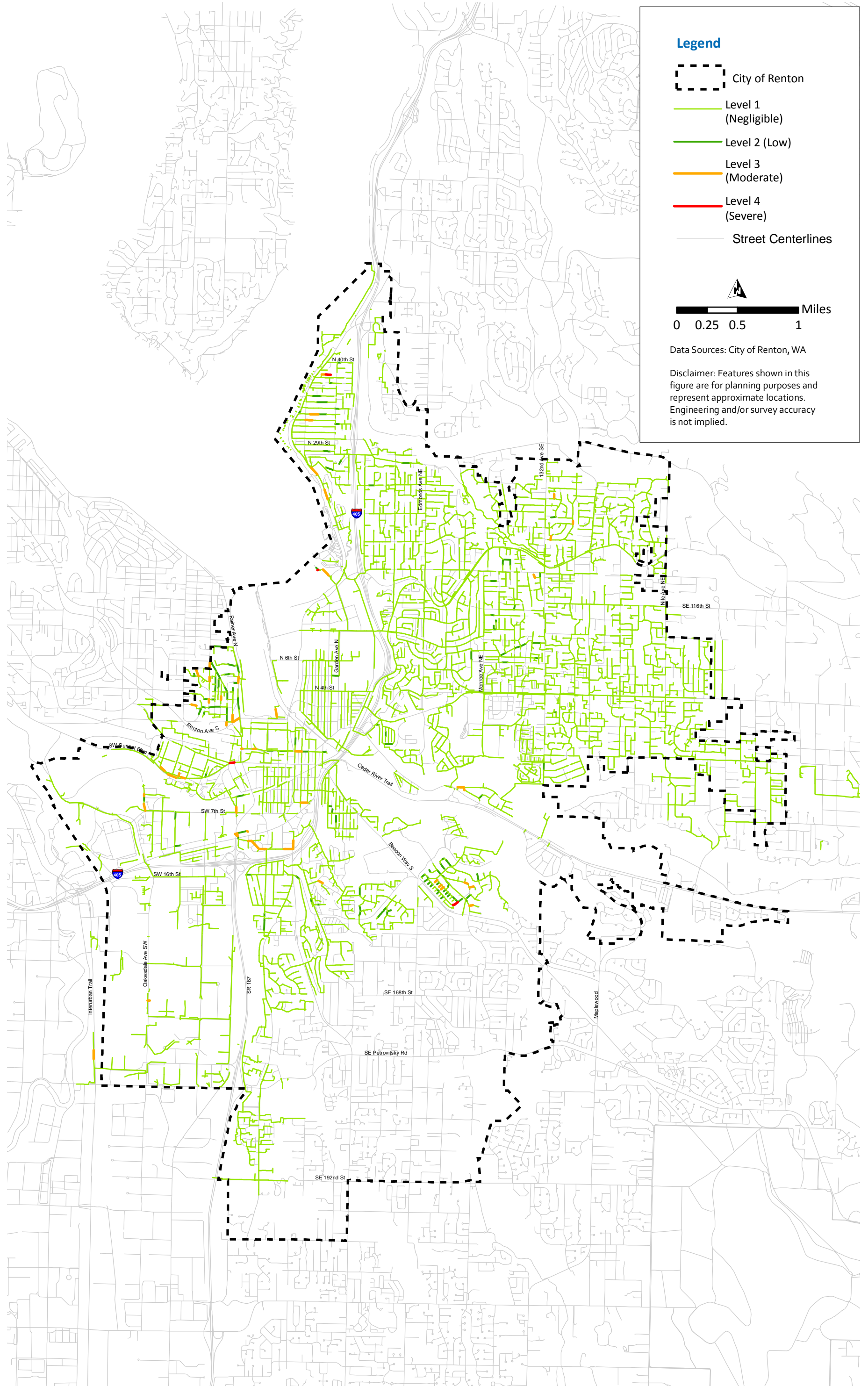
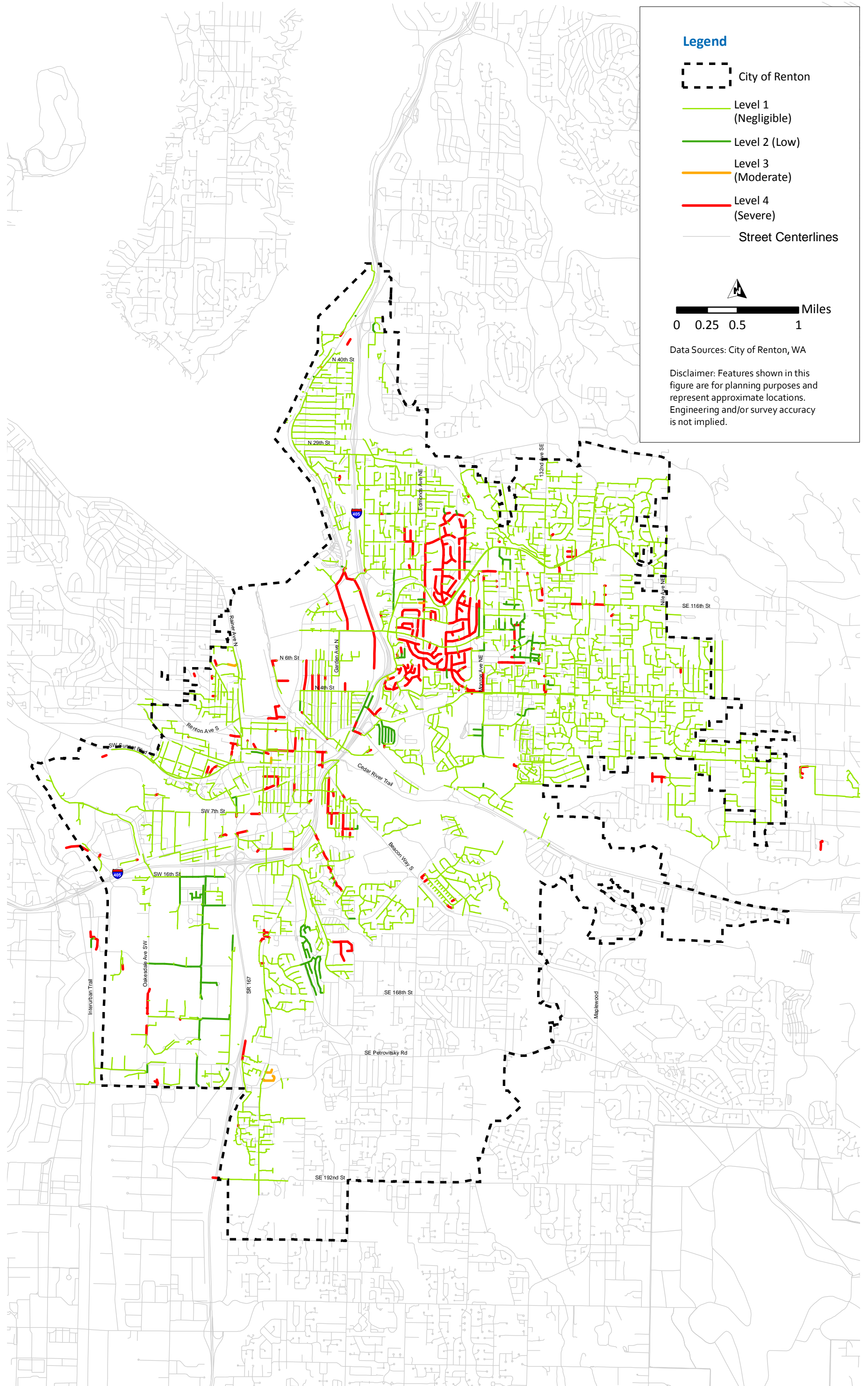

Figure 5.3 O&M Condition, CCTV Inspection Results



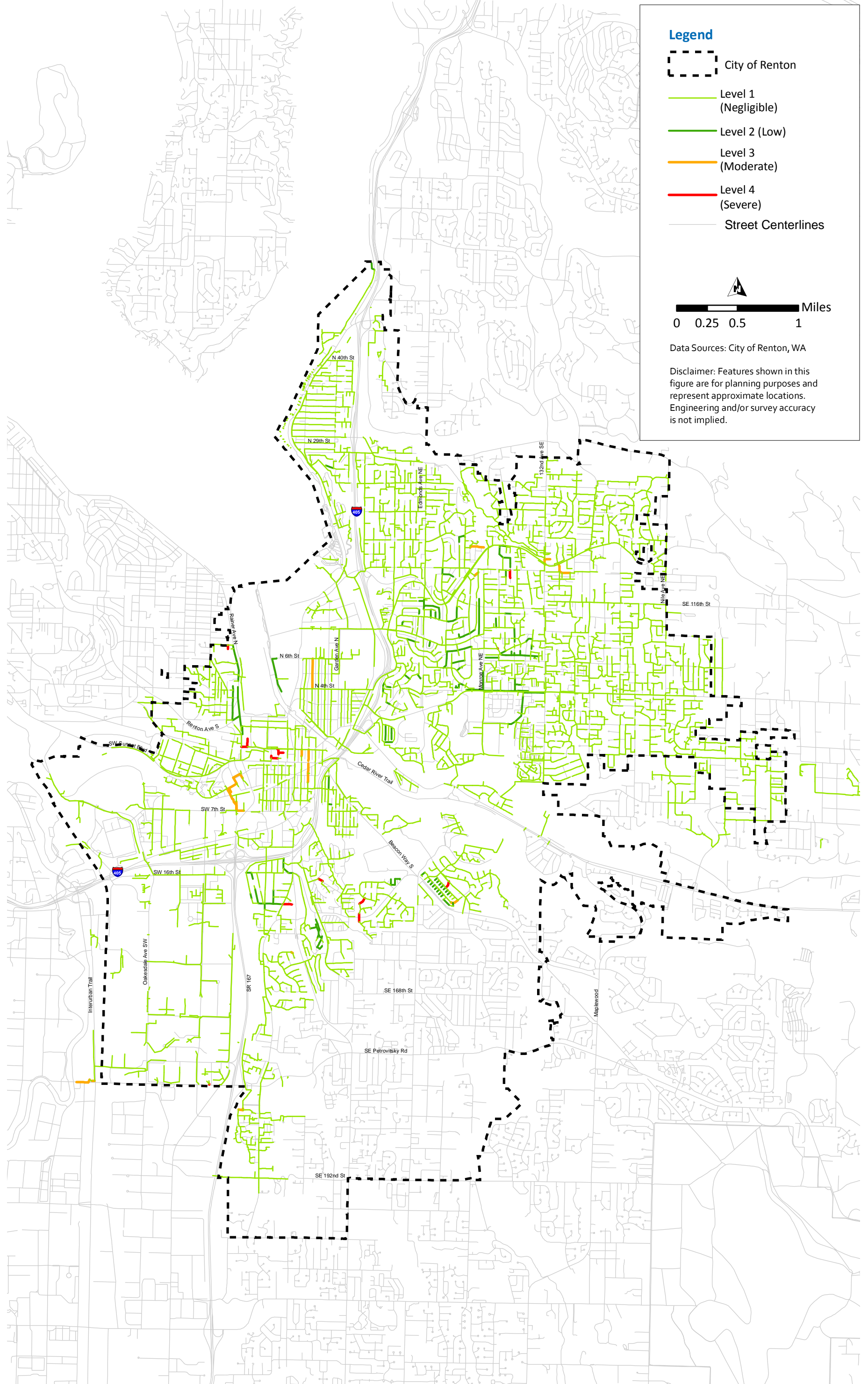

Figure 5.5 Frequency of Preventative Maintenance

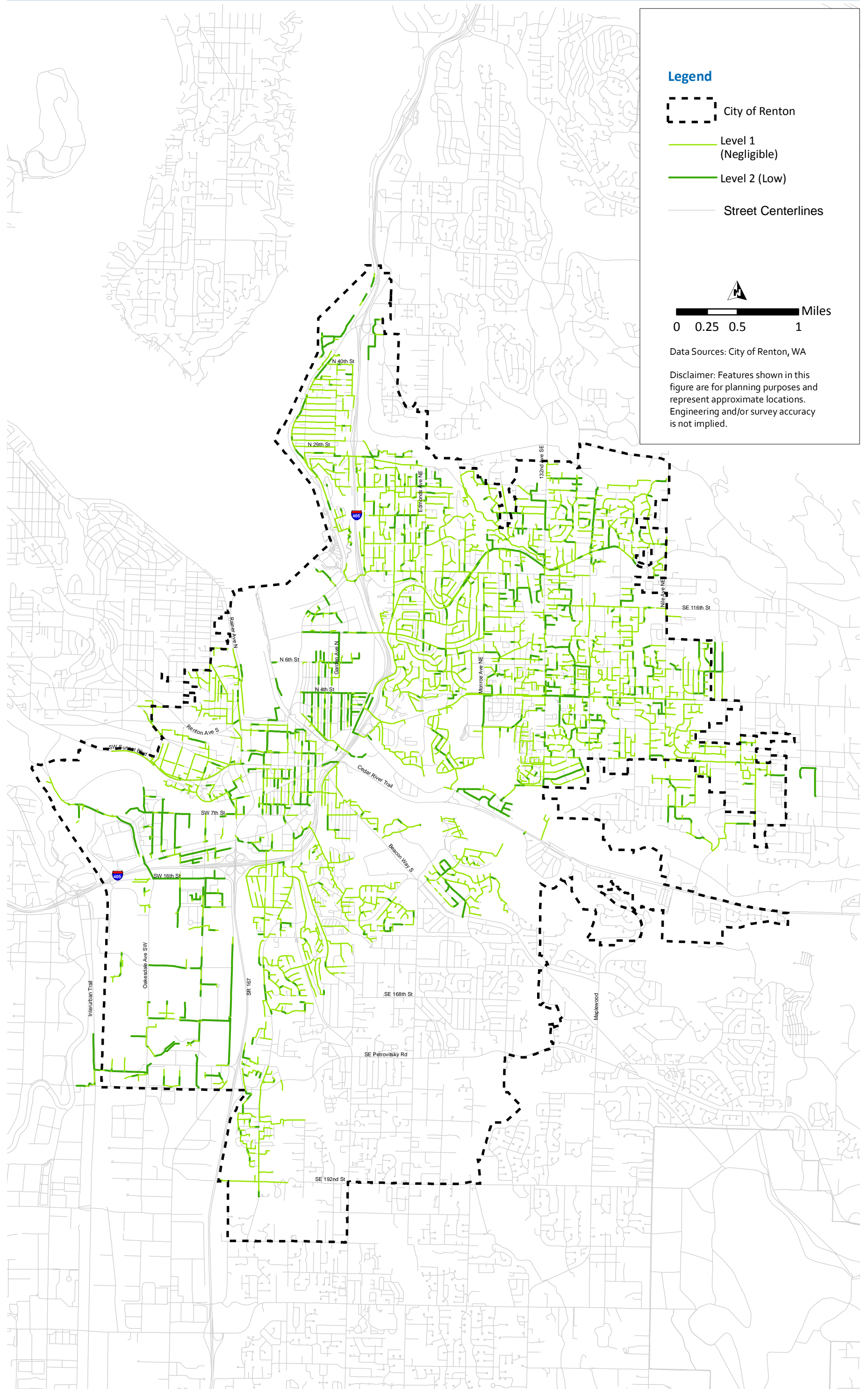
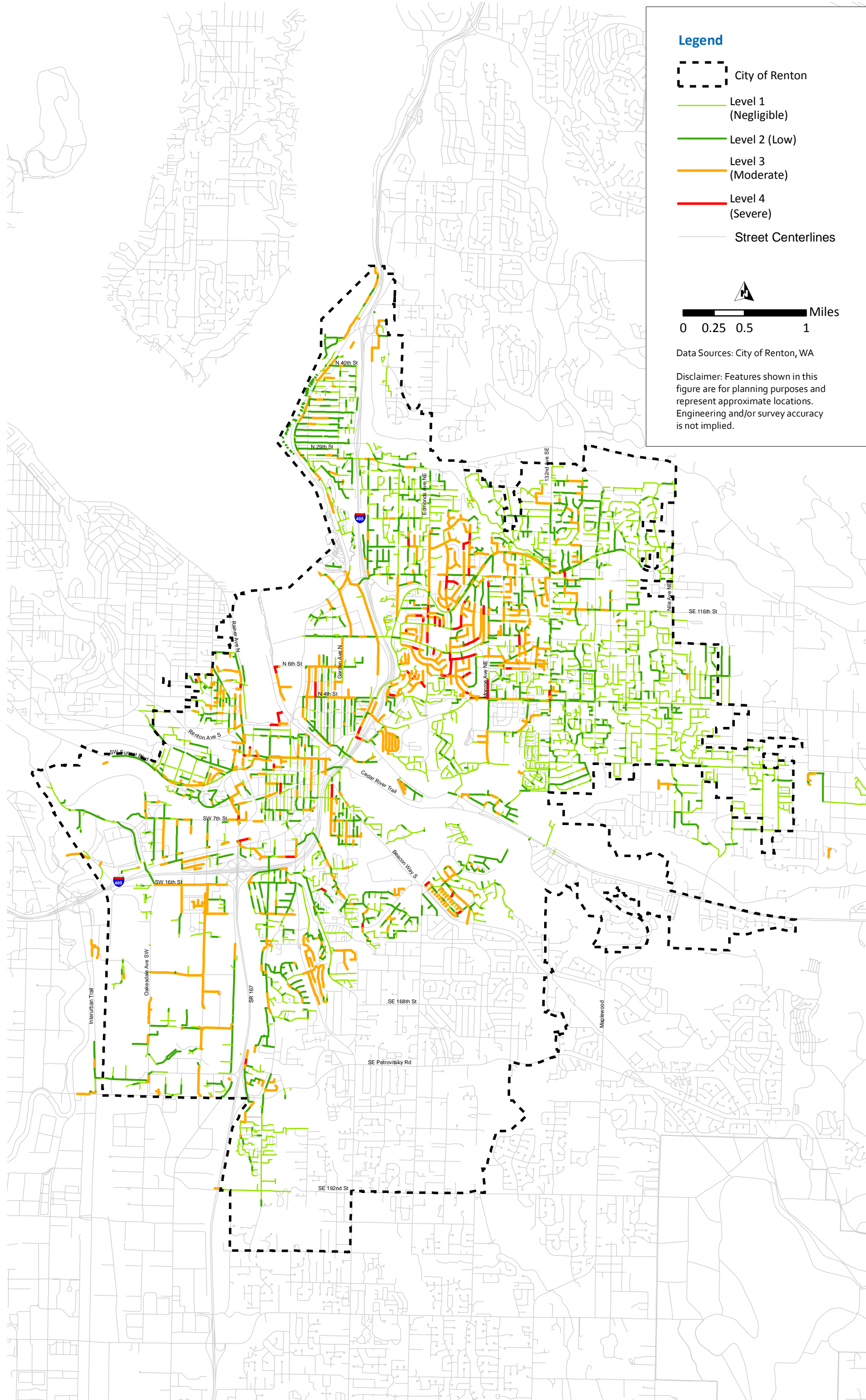

Figure 5.6 Slope of Pipe Segment Results



6.0 CRITICALITY RESULTS

Table 6.1 shows the amount of pipe found in each criticality level. Criticality level 1 pipes make up approximately 25.7 percent of the total pipe count. Criticality Level 2 pipes make up approximately 27.1 percent of the total pipe count. Pipes that fall into criticality level 3 represent approximately 34.7 percent of the total count. Pipes found in criticality level 4 have scores between 16 and 23, and make up approximately 13 percent of the total count.

Table 6.1 Criticality Score Range Long-Range Wastewater Management Plan City of Renton	
Criticality Level	Length (feet)
1 (negligible)	333,777
2 (low)	352,977
3 (moderate)	447,195
4 (severe)	<u>167,286</u>
Total:	1,301,234

Figure 6.1 shows the total criticality scores broken down for each criticality rating of the seven criteria for criticality. Each rating falls within the score range as shown in Table 4.2. The Loss of Critical Infrastructure and Transportation Links criteria increases significantly as the rating increases. This is due to both the larger weight it is given and the City's pipe segments being near critical infrastructure or a freeway.

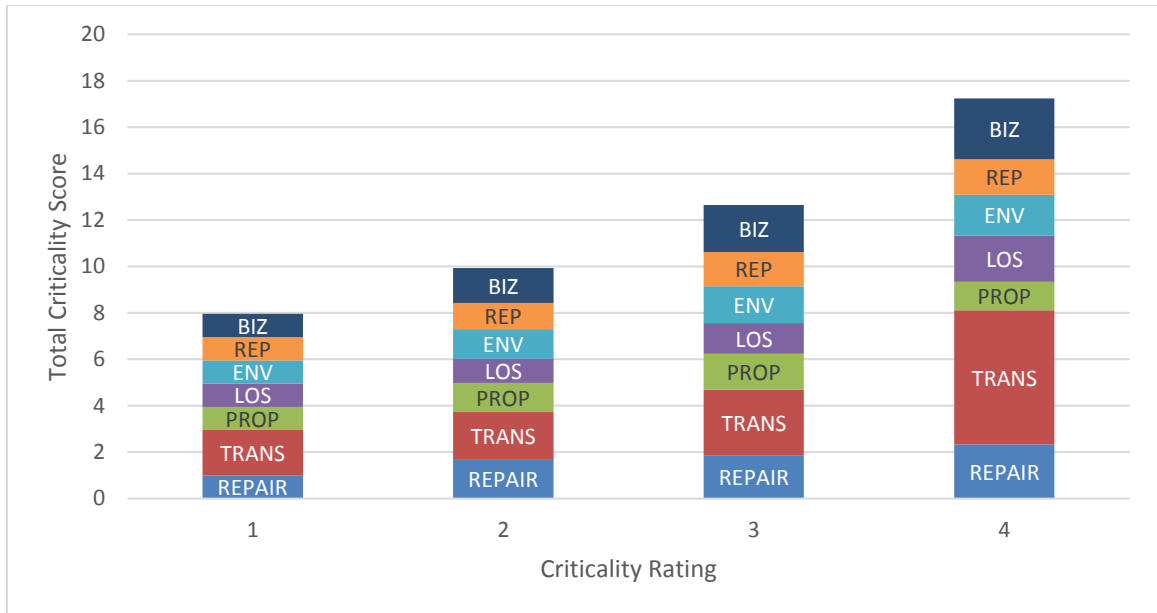
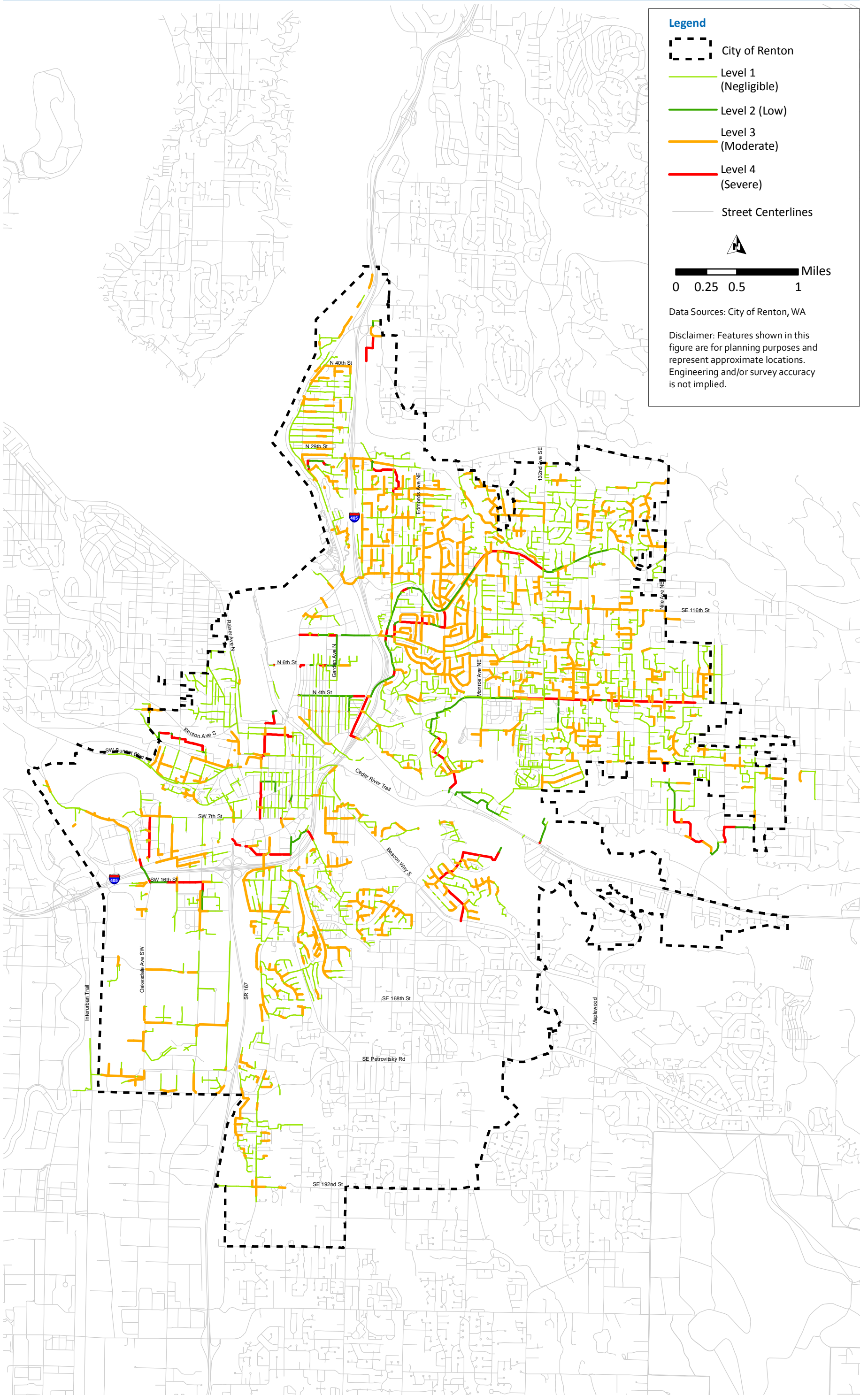

Figure 6.1 Summary of Criticality Rating and Scores

The results of the criticality scores for each criteria are shown in Figures 6.2 to 6.9. Similar to the vulnerability maps, the levels of criteria are color-coded to identify the different levels when compared with the location of the pipe. Figure 6.9 shows the overall criticality criteria ranking, with the majority of pipe in the severe and moderate levels located near the downtown area and major roadways. Figure 6.3 shows the moderate and severe level pipe found near the City's arterial streets and freeways. Figure 6.8 identifies the City's downtown area as moderately critical, as the area is an Overlay District.

The results are reasonable, since pipe in these areas would have a larger impact to the system should they be damaged.



Legend

- City of Renton
- Level 1 (Negligible)
- Level 2 (Low)
- Level 3 (Moderate)
- Level 4 (Severe)
- Street Centerlines

Miles
0 0.25 0.5 1

Data Sources: City of Renton, WA

Disclaimer: Features shown in this figure are for planning purposes and represent approximate locations. Engineering and/or survey accuracy is not implied.

Figure 6.2 Cost to Repair Failure Results

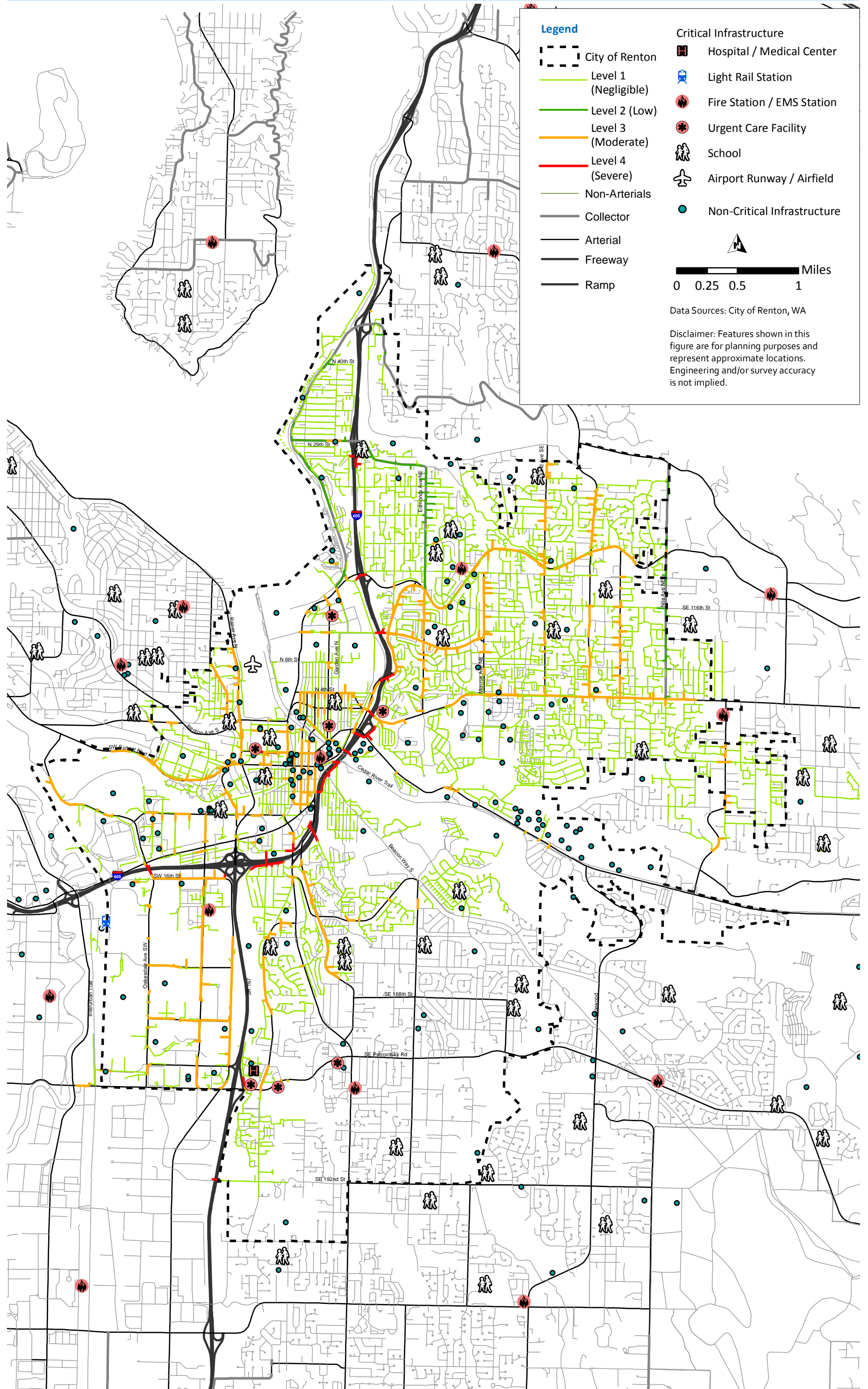

Figure 6.3 Loss of Critical Infrastructure and Transportation Links Results

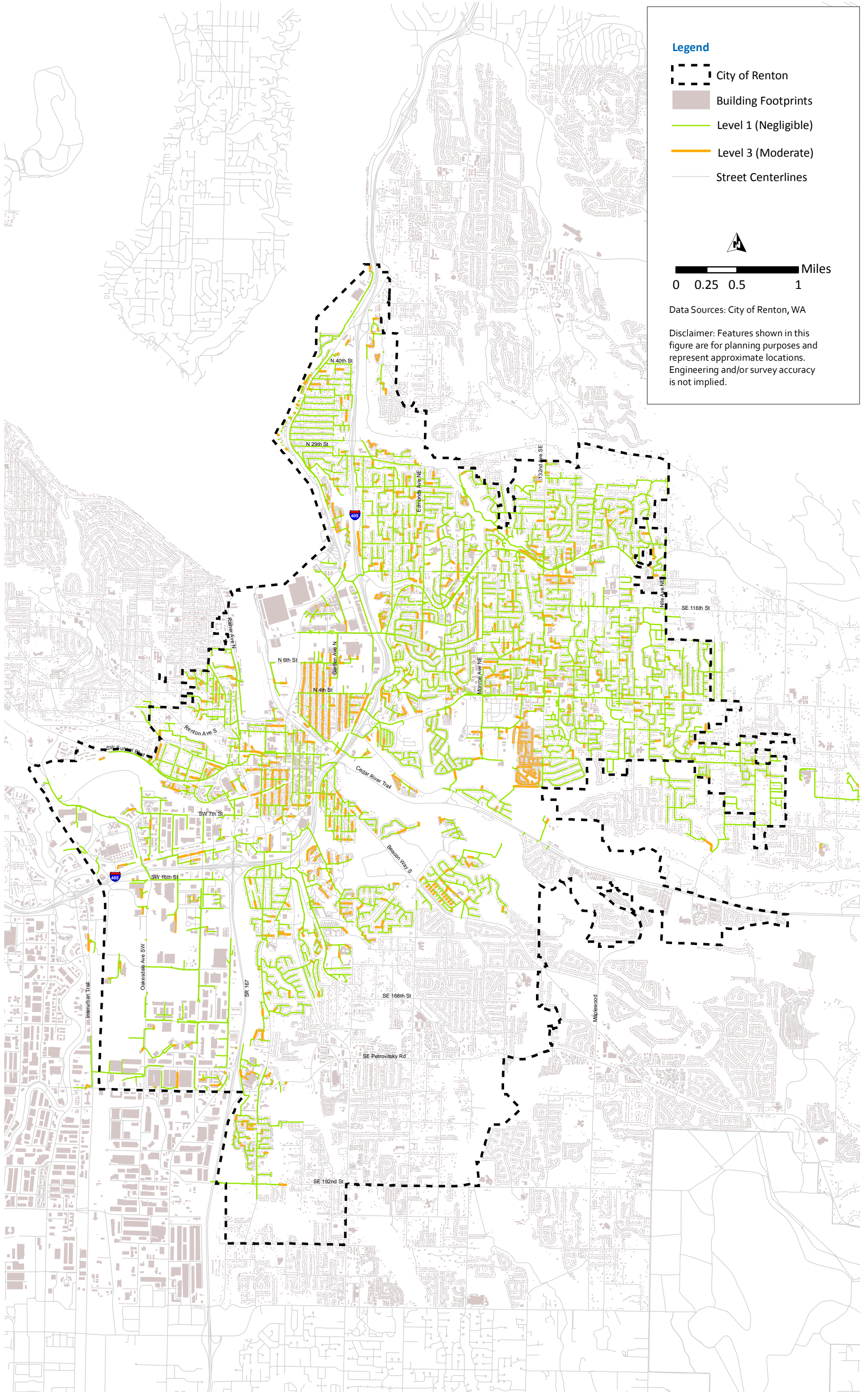

Figure 6.4 Damage to Property Results

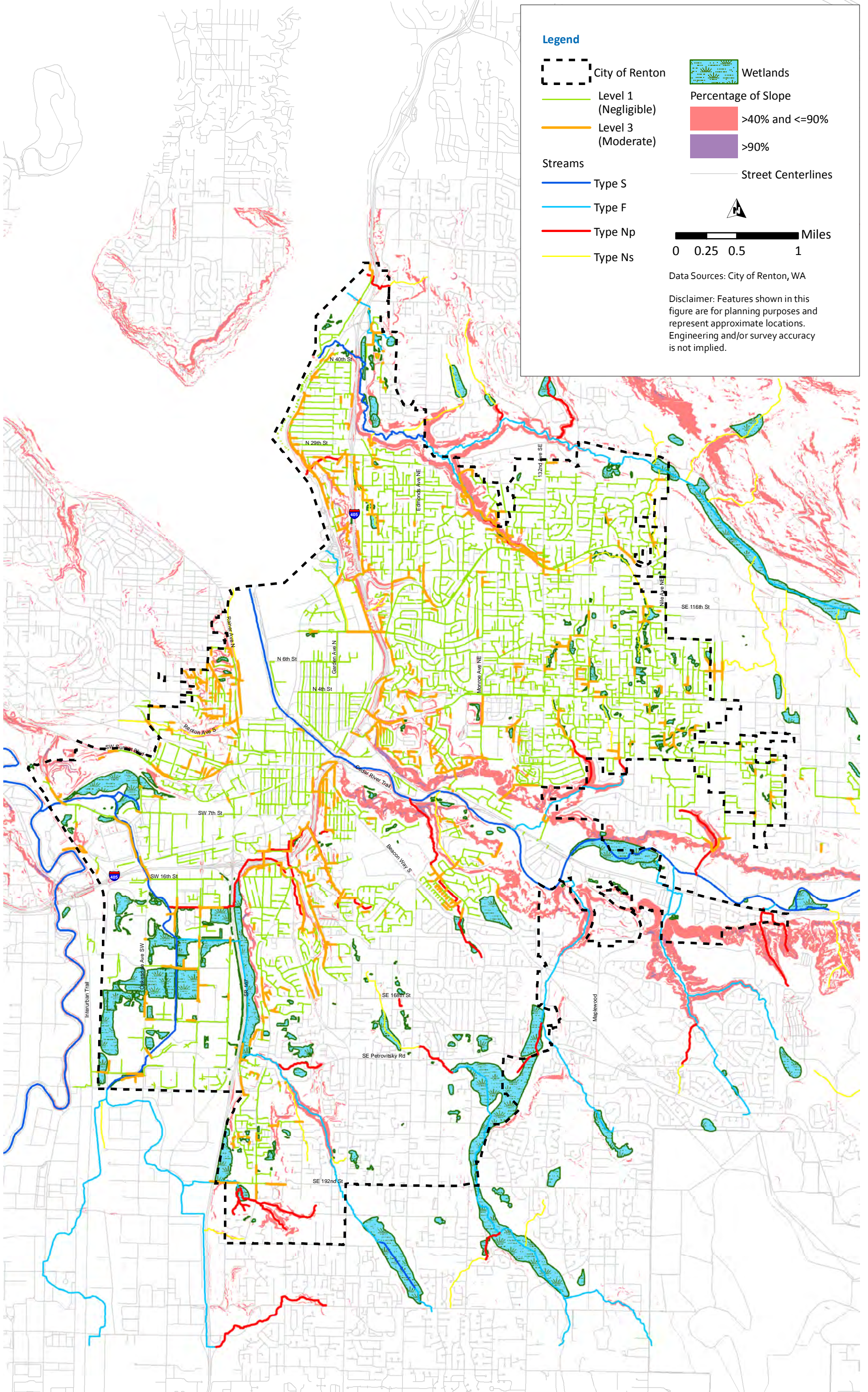

Figure 6.5 Environmental Impact Results

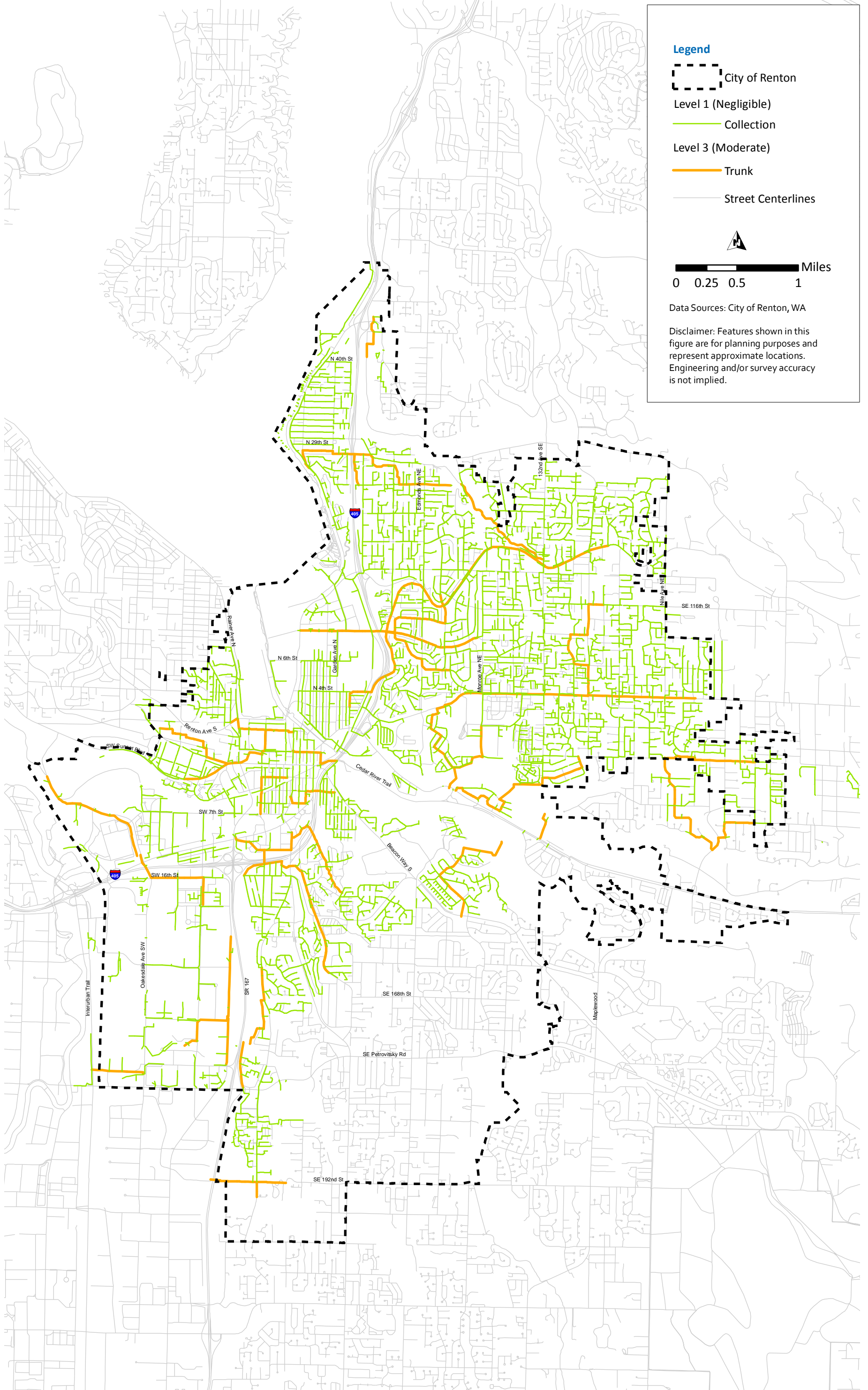

Figure 6.6 Loss of Service to Customers Results

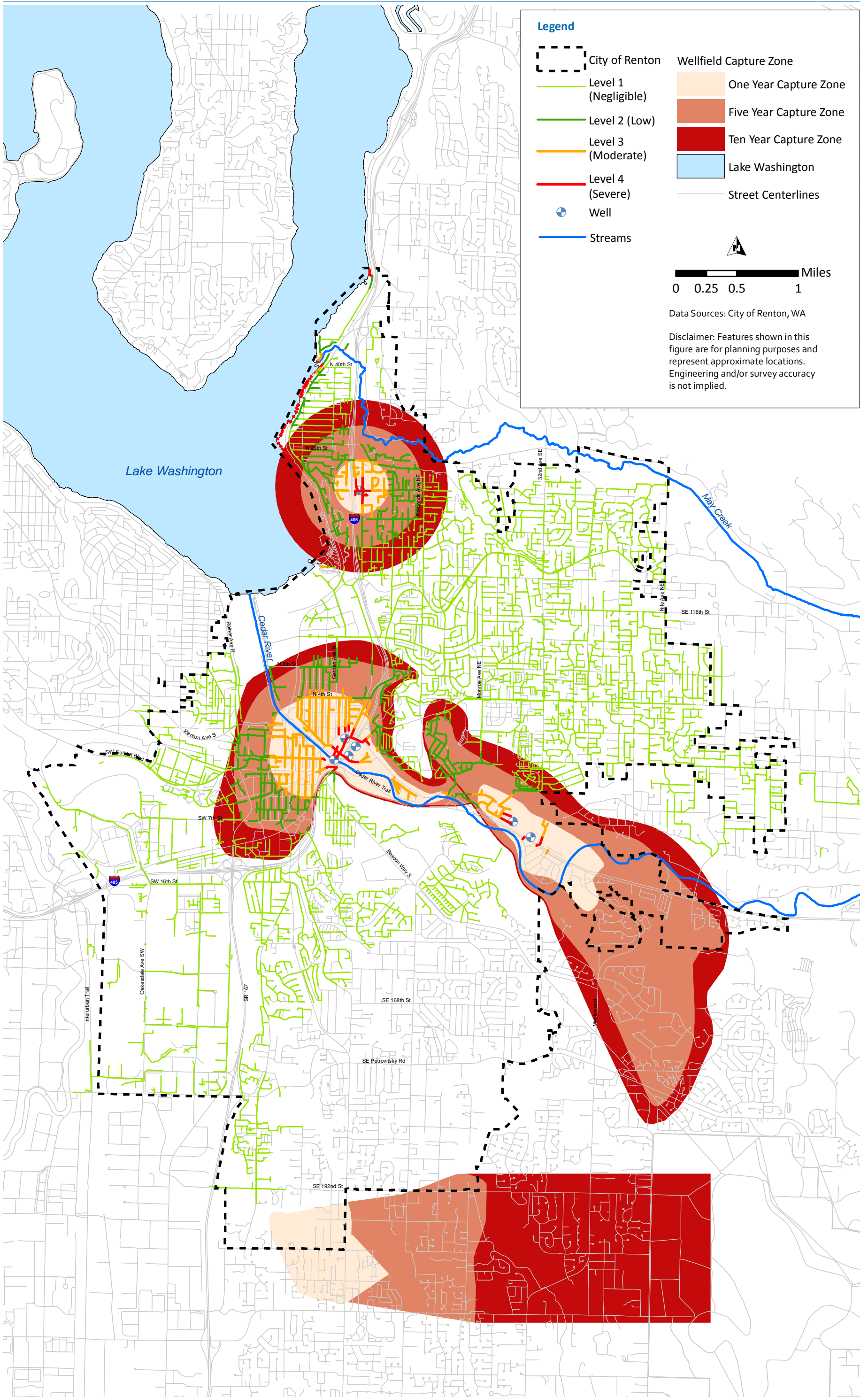

Figure 6.7 Reputational Damage Results

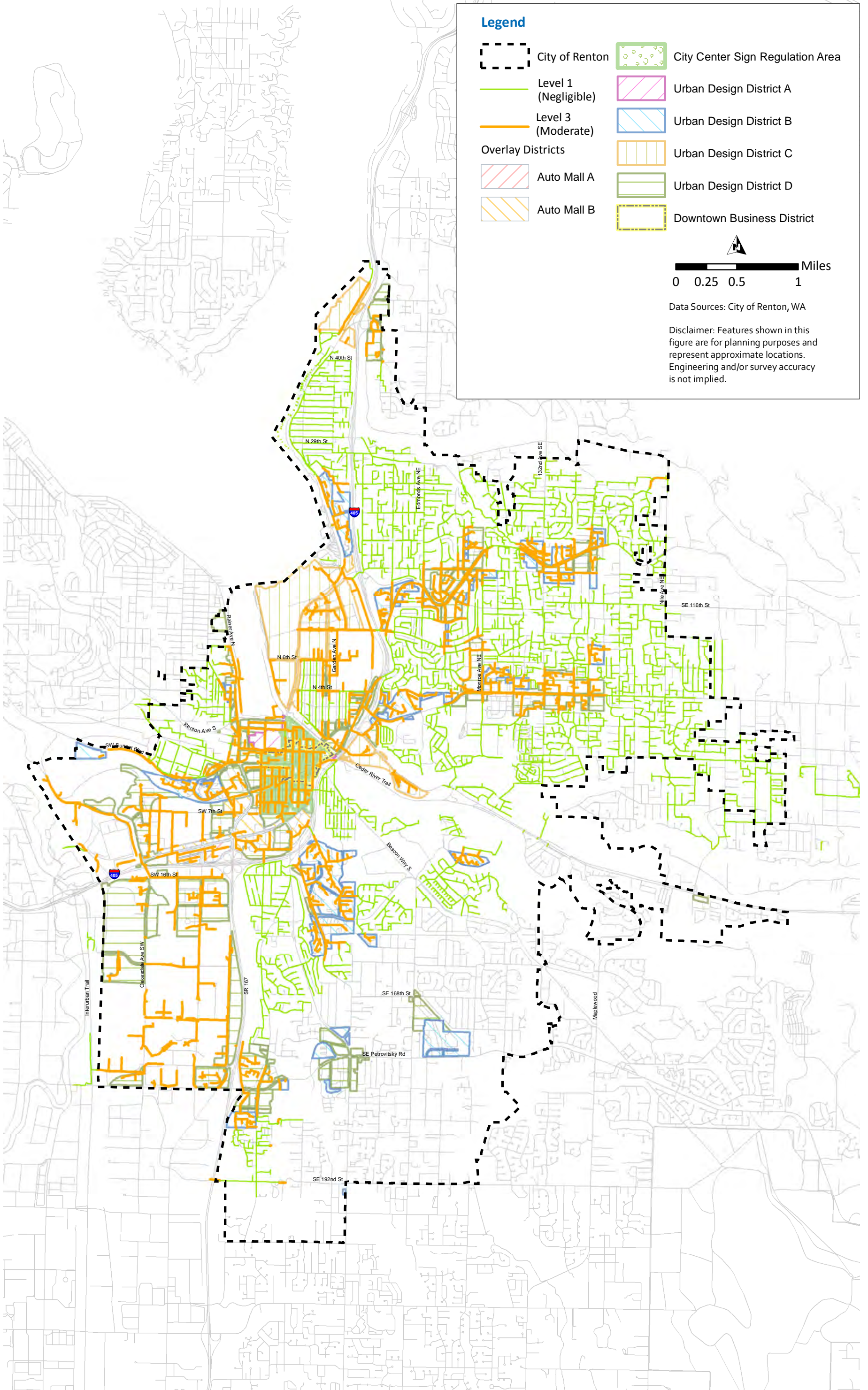
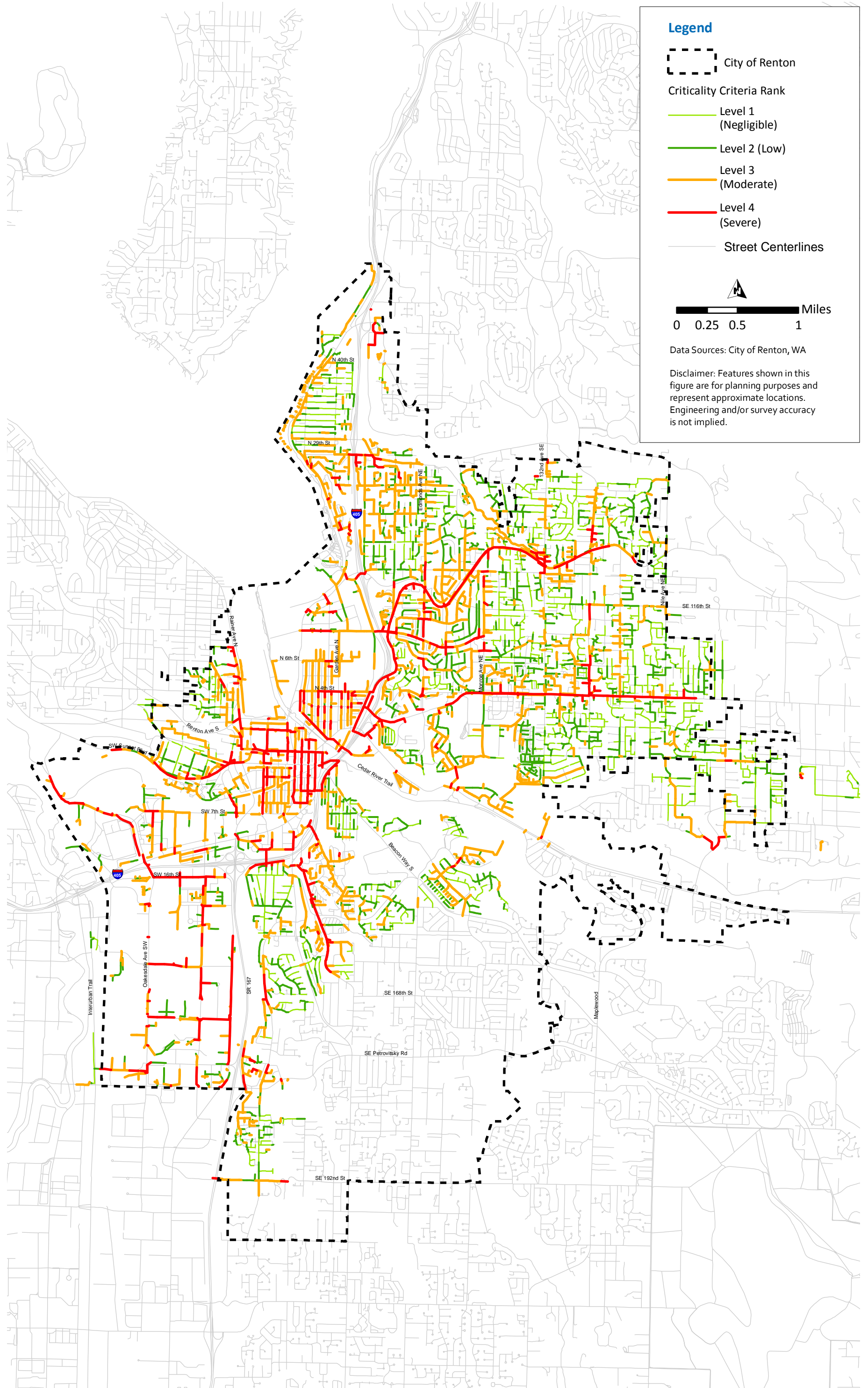

Figure 6.8 Damage to Local Business and Economy Results



7.0 RISK

Figure 7.1 shows the final result of the normalized risk ranking for the City's piping system. There are 16 combinations that have been designated one of four colors, which represents the overall level of risk. For example, a risk rating that has a vulnerability rating of 4 but a criticality rating of 1 (shown on Figure 7.1 as 1,4) receives a light green designation, or a moderately low risk rating as shown in Table 6.2. The amount of pipe that falls in each risk ranking is shown in Table 7.1 and the amount of pipe length based on the four colored risk ranking are shown in Table 7.2. Approximately 782,000 feet, or 60 percent, of the City's piping system falls in the low or moderately low categories. The city has approximately 379,000 feet, or 29 percent, of the piping system in the moderately-high (yellow) category. And approximately 140,000 feet, or 11 percent of the piping system, falls in the red, or high risk, category.

Table 7.1 Normalized Risk Ratings Long-Range Wastewater Management Plan City of Renton					
Normalized Risk Ranking					
Vulnerability Level	4 (severe)	18,503 (%1.4)	38,202 (%2.9)	63,030 (%4.8)	13,364 (%1.0)
	3 (moderate)	97,627 (%7.5)	95,897 (%7.4)	140,271 (%10.8)	63,978 (%4.9)
	2 (low)	27,886 (%2.1)	48,447 (%3.7)	70,219 (%5.4)	34,028 (%2.6)
	1 (negligible)	189,761 (%14.6)	170,430 (%13.1)	173,675 (%13.3)	55,916 (%4.3)
		1 (negligible)	2 (low)	3 (moderate)	4 (severe)
		Criticality Level			

Table 7.2 Pipe Length Totals Based on Risk Rating Long-Range Wastewater Management Plan City of Renton		
Color	Total Length (ft)	% of Total Length
Low	388,077	30%
Moderately-Low	394,169	30%
Moderately-High	378,617	29%
High	140,372	11%

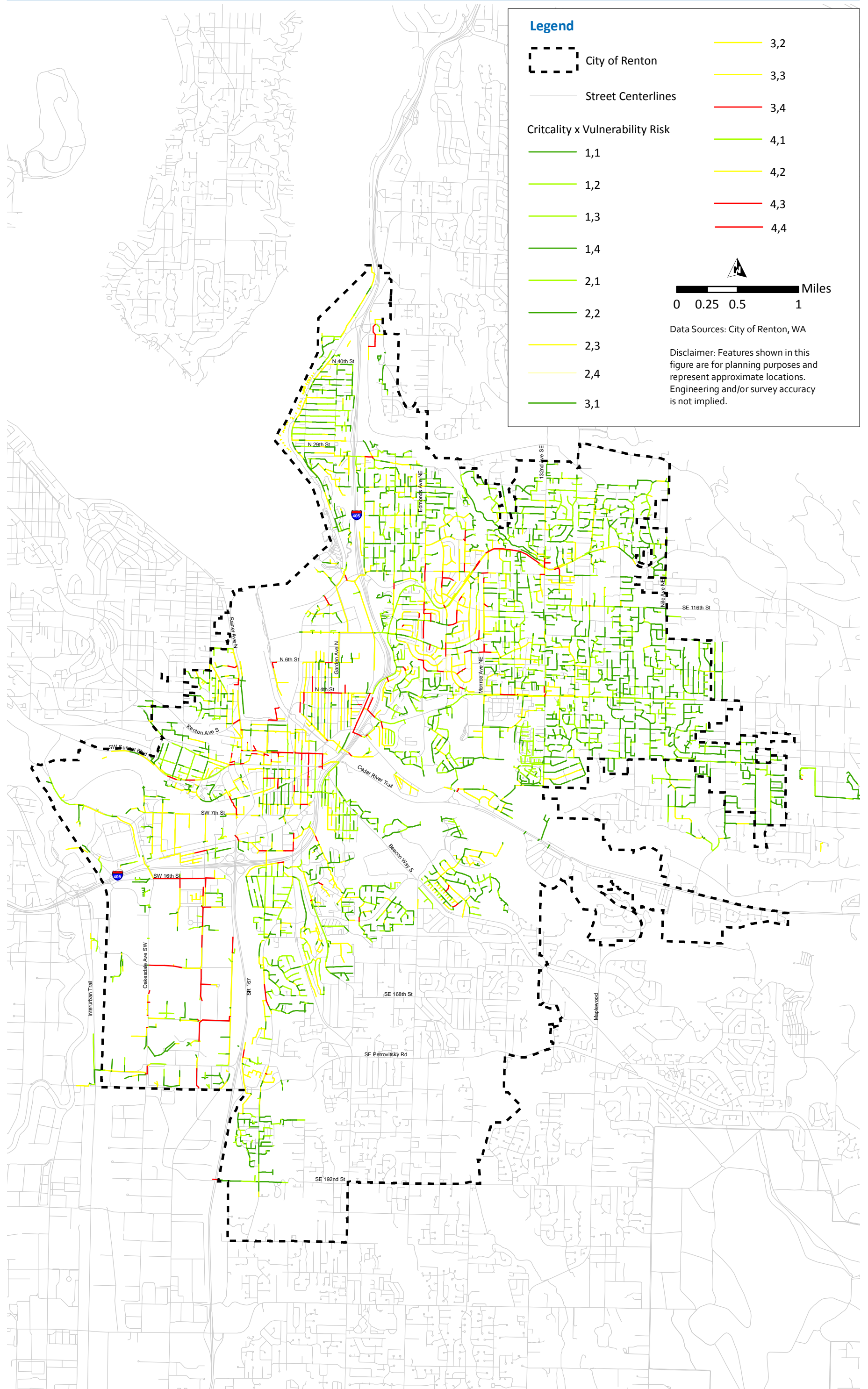

Figure 7.1 Map of Criticality x Vulnerability

Appendix J

STANDARD PLANS AND SPECIFICATIONS

SPECIAL PROVISIONS	12
1-01 DEFINITIONS AND TERMS	12
1-01.1 General.....	12
1-01.3 Definitions	12
1-02 BID PROCEDURES AND CONDITIONS	15
1-02.1 Prequalification of bidders.....	15
1-02.2 Plans and Specifications.....	15
1-02.5 Proposal Forms.....	16
1-02.6 Preparation of Proposal	16
1-02.6(1) Proprietary Information.....	17
1-02.7 Bid Deposit.....	17
1-02.9 Delivery of Proposal	18
1-02.12 Public Opening of Proposals.....	18
1-02.13 Irregular Proposals	18
1-02.14 Disqualification of Bidders	18
1-02.15 Pre Award Information.....	19
1-03 AWARD AND EXECUTION OF CONTRACT	19
1-03.1 Consideration of bids	19
1-03.2 Award of Contract.....	20
1-03.3 Execution of Contract.....	20
1-03.4 Contract Bond.....	20
1-03.7 Judicial Review	21
1-04 SCOPE OF WORK.....	21
1-04.2 Coordination of Contract Documents... ..	21
1-04.8 Progress Estimates and Payments	22
1-04.11 Final Cleanup.....	22
1-04.3 Contractor-Discovered Discrepancies.....	22
1-05 CONTROL OF WORK.....	22
1-05.4 Conformity With and Deviation from Plans and Stakes	22
1-05.4(3) Contractor Supplied Surveying.....	24
1-05.4(4) Contractor Provided As-Built Information	24
1-05.7 Removal of Defective and Unauthorized Work	25
1-05.10 Guarantees	26
1-05.11 Final Inspection.....	26

1-05.11(1) Substantial Completion Date.....	26
1-05.11(2) Final Inspection and Physical Completion Date.....	27
1-05.11(3) Operational Testing	28
1-05.12 Final Acceptance	28
1-05.13 Superintendents, Labor and Equipment of Contractor	28
1-05.14 Cooperation with Other Contractors.....	29
1-05.16 Water and Power	29
1-05.17 Oral Agreements	29
1-05.18 Contractor's Daily Diary	29
1-06 CONTROL OF MATERIAL	31
1-06.1 Approval of Materials Prior to Use	31
1-06.2(1) Samples and Tests for Acceptance	31
1-06.2(2) Statistical Evaluation of Materials for Acceptance.....	31
1-07 LEGAL RELATIONS AND RESPONSIBILITIES TO THE PUBLIC.....	31
1-07.1 Laws to be Observed.....	31
1-07.6 Permits and Licenses	32
1-07.9 Wages	33
1-07.9(5) Required Documents	33
1-07.11 Requirements for Non-Discrimination	33
1-07.11(11) City of Renton Affidavit of Compliance	33
1-07.12 Federal Agency Inspection	33
1-07.13 Contractor's Responsibility for Work	34
1-07.13(1) General	34
1-07.15 Temporary Water Pollution/Erosion Control	34
1-07.16 Protection and Restoration of Property.....	36
1-07.16(1) Private/Public Property	36
1-07.17 Utilities and Similar Facilities	38
1-07.17(1) Site Specific Potholing.....	39
1-07.17(3) Interruption of Services	40
1-07.17(4) Resolution of Utility Conflicts	40
1-07.18 Public Liability and Property Damage Insurance	40
1-07.18(1) General	40
1-07.18(2) Coverages	41
1-07.18(3) Limits	42
1-07.18(4) Evidence of Insurance:	43

1-07.22	Use of Explosives	44
1-07.23	Public Convenience and Safety.....	44
1-07.23(1)	Construction Under Traffic	44
1-07.23(2)	Construction and Maintenance of Detours	46
1-07.24	Rights of Way	46
1-07.28	Confined Space Entry.....	47
1-08	PROSECUTION AND PROGRESS.....	47
1-08.0	Preliminary Matters.....	47
1-08.0(1)	Preconstruction Conference	47
1-08.0(2)	Hours of Work.....	49
1-08.0(3)	Reimbursement for Overtime Work of Contracting Agency Employees	49
1-08.1	Subcontracting.....	50
1-08.2	Assignment	50
1-08.3	Progress Schedule	50
1-08.4	Notice to Proceed and Prosecution of the Work	52
1-08.5	Time For Completion	52
1-08.6	Suspension of Work	54
1-08.7	Maintenance During Suspension	54
1-08.9	Liquidated Damages.....	54
1-08.11	Contractor's Plant and Equipment	55
1-08.12	Attention to Work.....	55
1-09	MEASUREMENT AND PAYMENT	55
1-09.1	Measurement of Quantities.....	55
1-09.3	Scope of Payment.....	56
1-09.6	Force Account.....	57
1-09.7	Mobilization	57
1-09.9	Payments	58
1-09.9(1)	Retainage	59
1-09.9(2)	Contracting Agency's Right to Withhold and Disburse Certain Amounts	59
1-09.9(3)	Final Payment	60
1-09.11	Disputes and Claims.....	61
1-09.11(2)	Claims	61
1-09.11(3)	Time Limitations and Jurisdiction	61
1-09.13	Claims and Resolutions	62

1-09.13(3) Claims \$250,000 or Less	62
1-09.13(3)A Administration of Arbitration	62
1-09.13(3)B Procedures to Pursue Arbitration	62
1-09.14 Payment Schedule	63
1-09.14(1) Scope.....	63
1-09.14(2) Bid Items	63
1-10 TEMPORARY TRAFFIC CONTROL	95
1-10.1 General.....	95
1-10.2(1)B Traffic Control Supervisor.....	97
1-10.2(2) Traffic Control Plans	97
1-10.3 Flagging, Signs, and All Other Traffic Control Devices.....	97
1-10.3(3) Construction Signs	97
1-10.3(3) Construction Signs	97
1-10.4 Measurement.....	97
1-10.5 Payment.....	98
1-11 RENTON SURVEYING STANDARDS.....	98
1-11.1(1) Responsibility for surveys.....	98
1-11.1(2) Survey Datum and Precision	98
1-11.1(3) Subdivision Information.....	99
1-11.1(4) Field Notes	99
1-11.1(5) Corners and Monuments	99
1-11.1(6) Control or Base Line Survey	99
1-11.1(7) Precision Levels	100
1-11.1(8) Radial and Station -- Offset Topography	100
1-11.1(9) Radial Topography	100
1-11.1(10) Station--Offset Topography	101
1-11.1(11) As-Built Survey	101
1-11.1(12) Monument Setting and Referencing	101
1-11.12 Materials.....	102
1-11.12(1) Property/Lot Corners.....	102
1-11.12(2) Monuments.....	102
1-11.12(3) Monument Case and Cover	102
2-01 CLEARING, GRUBBING, AND ROADSIDE CLEANUP.....	102
2-01.1 Description	102
2-01.2 Disposal of Usable Material and Debris.....	103

2-01.5	Payment.....	103
2-02	REMOVAL OF STRUCTURE AND OBSTRUCTIONS.....	103
2-02.3(3)	Removal of Pavement, Sidewalks, and Curbs	103
2-02.4	Measurement.....	103
2-02.5	Payment.....	103
2-03	ROADWAY EXCAVATION AND EMBANKMENT	104
2-03.3	Construction Requirements.....	104
2-03.4	Measurement.....	105
2-03.5	Payment	105
2-04	HAUL	106
2-04.5	Payment.....	106
2-06	SUBGRADE PREPARATION.....	106
2-06.5	Measurement and Payment	106
2-09	STRUCTURE EXCAVATION	106
2-09.1	Description	106
2-09.3(1)D	Disposal of Excavated Material	106
2-09.4	Measurement.....	106
2-09.5	Payment	107
5-04	ASPHALT CONCRETE PAVEMENT.....	108
5-06	TEMPORARY RESTORATION IN PAVEMENT AREAS.....	137
5-06.1	Description	137
5-06.2	Materials	137
5-06.3	Construction Requirements.....	137
7-01	DRAINS	138
7-01.2	Materials	138
7-01.3	Construction Requirements.....	138
7-01.4	Measurement.....	138
7-02	CULVERTS.....	138
7-02.2	Materials	138
7-04	STORM SEWERS	139
7-04.2	Materials	139
7-04.2	Materials	139
7-04.3(1)	Cleaning and Testing	139
7-04.3(1)G	Abandon Existing Storm Sewer Pipes.....	140
7-04.3(2)	CCTV Inspection.....	141

7-04.3(3) Direct Pipe Connections	141
7-05 MANHOLES, INLETS, AND CATCH BASINS	141
7-05.3 Construction Requirements.....	141
7-05.3(1) Adjusting Manholes and Catch Basins to Grade.....	142
7-05.3(3) Connections to Existing Manholes.....	143
7-05.3(5) Manhole Coatings.....	143
7-06 TRENCH DRAINS (NEW SECTION)	144
7-06.1 Description	144
7-06.2 Materials	144
7-06.3 Construction Requirements.....	144
7-08 GENERAL PIPE INSTALLATION REQUIREMENTS	145
7-08.3 Construction Requirements.....	145
7-08.3(1)A Trenches	145
7-08.3(1)C Bedding the Pipe.....	145
7-08.3(1)D Pipe Foundation.....	146
7-08.3(2)A Survey Line and Grade	146
7-08.3(2)B Pipe Laying – General	146
7-08.3(2)E Rubber Gasketed Joints.....	147
7-08.3(2)H Sewer Line Connections	147
7-08.3(2)J Placing PVC Pipe.....	147
7-08.3(3)A Backfilling Pipe Trenches.....	147
7-04.2(2) Temporary Stormwater Diversion	148
7-17.4 Measurement.....	149
7-09 PIPE AND FITTINGS FOR WATER MAINS.....	149
7-09.3(15)A Ductile Iron Pipe.....	149
7-09.3(15)B Polyvinyl Chloride (PVC) Pipe (4 inches and Over).....	150
7-09.3(17) Laying Ductile Iron Pipe and Fittings with Polyethylene Encasement	150
7-09.3(19)A Connections to Existing Mains.....	150
7-09.3(21) Concrete Thrust Blocking and Dead-Man Block	152
7-09.3(23) Hydrostatic Pressure Test	153
7-09.3(24)A Flushing and Poly-pigging	155
7-09.3(24)D Dry Calcium Hypochlorite	155
7-09.3(24)K Retention Period	156
7-09.3(24)N Final Flushing and Testing.....	156

7-09.3(25) Joint Restraint Systems.....	156
7-09.4 Measurement.....	158
7-09.5 Payment.....	158
7-12 VALVES FOR WATER MAINS	159
7-12.3(1) Installation of Valve Marker Post	159
7-12.3(2) Adjust Existing Valve Box to Grade.....	159
7-12.4 Measurement.....	159
7-12.5 Payment.....	160
7-14 HYDRANTS.....	160
7-14.3(1) Setting Hydrants.....	160
7-14.3(3) Resetting Existing Hydrants.....	161
7-14.3(4) Moving Existing Hydrants	161
7-14.3(7) Remove and Salvage Hydrant.....	161
7-14.5 Payment.....	162
7-15 SERVICE CONECTIONS	162
7-15.3 Construction Details.....	162
7-15.5 Payment.....	163
7-17 SANITARY SEWERS	163
7-17.2 Materials	163
7-17.3 Construction Requirements.....	164
7-17.3(1) Protection of Existing Sewerage Facilities	164
7-17.3(2)H Television Inspection.....	164
7-17.3(2)I Abandon Existing Sanitary Sewer Pipes.....	165
7-17.5 Payment.....	165
7-17.4 Measurement.....	165
7-17.4 Measurement.....	165
7-17.4 Measurement.....	166
7-17.4 Measurement.....	166
7-17.4 Measurement.....	166
7-21 GENERAL SPECIFICATIONS FOR CURED IN PLACE PIPE (CIPP)	166
7-21.1 Description	166
7-21.1(2) Licensing.....	166
7-21.1(3) Contractor and Manufacturer Qualifications	167
7-21.1(4) Contractor Submittals.....	167

7-21.1(6) Warranty	168
7-21.2 Materials	169
7-21.2 Cured in Place Resin Impregnated Material in General.....	169
7-21.2 Cured in Place Resin Impregnated Material in General.....	169
7-21.2 Cured in Place Resin Impregnated Material in General.....	170
7-21.2(2) Resin	171
7-21.2(3) Physical Properties	173
7-21.3 Construction Requirements.....	174
7-21.3(1)A Flow Management.....	174
7-21.3(1)B Cleaning	175
7-21.3(1)C Point Repairs.....	176
7-21.3(1)D Manholes	177
7-21.3(1)D Manholes	177
7-21.3(2) Liner Installation	177
7-21.3(2) Liner Installation	178
7-21.3(4) Testing.....	180
7-21.3(4)C Post Installation CCTV Inspection	180
7-21.3(4)A Material Testing	180
7-21.3(4)B Field Testing.....	181
7-21.4 Measurement	181
7-21.4 Measurement	181
7-21.5 Payment	181
7-21 GENERAL SPECIFICATIONS FOR CURED IN PLACE PIPE (CIPP)	181
8-02 ROADSIDE RESTORATION	181
8-02.3(4)A Topsoil Type A	181
8-02.3(16)A Lawn Installation	181
8-02.3(16)A2 Submittals.....	181
8-02.3(16)A2a Certification of Material	181
8-02.3(16)A2b Manufacturer’s Certificates of Conformance	182
8-02.3(16)A2c Schedule for Installation	182
8-02.3(16)A3 Product Handling	182
8-02.3(16)A4 Site Information.....	182
8-02.3(16)A5 Sod	182
8-02.3(16)A5a Other Materials.....	182

8-02.3(16)A6 Execution.....	182
8-02.3(16)A6a Installation Preparation.....	183
8-02.3(16)A6b Sod Installation.....	183
8-02.3(16)B Lawn Establishment.....	183
8-02.3(16)B Lawn Establishment and Final Acceptance.....	183
8-02.3(16)B1 Establishment Period.....	183
8-02.3(16)B2 Guarantee.....	184
8-02.3(16)B3 Final Acceptance.....	184
8-09 RAISED PAVEMENT MARKERS.....	184
8-09.5 Payment.....	184
8-13 MONUMENT CASES.....	185
8-13.1 Description.....	185
8-13.3 Construction Requirements.....	185
8-13.4 Measurement.....	185
8-13.5 Payment.....	185
8-14 CEMENT CONCRETE SIDEWALKS.....	185
8-14.3(4) Curing.....	185
8-14.4 Measurement.....	186
8-14.5 Payment.....	186
8-17 IMPACT ATTENUATOR SYSTEMS.....	186
8-17.5 Payment.....	186
8-20 ILLUMINATION, TRAFFIC SIGNAL SYSTEMS, AND ELECTRICAL.....	187
8-20.2(1) Equipment List and Drawings.....	187
8-22 PAVEMENT MARKING.....	187
8-22.1 Description.....	187
8-22.3(5) Installation Instructions.....	188
8-22.5 Payment.....	188
8-23 TEMPORARY PAVEMENT MARKINGS.....	189
8-23.5 Payment.....	189
9-03.8(7) HMA Tolerances and Adjustments.....	189
9-05 DRAINAGE STRUCTURES, CULVERTS, AND CONDUITS.....	190
9-05.4 Steel Culvert Pipe and Pipe Arch (RC).....	190
9-05.7(2) Reinforced Concrete Storm Sewer Pipe (RC).....	190
9-05.7(2)A Basis for Acceptance (RC).....	190
9-05.7(3) Concrete Storm Sewer Pipe Joints (RC).....	190

9-05.7(4) Testing Concrete Storm Sewer Pipe Joints (RC).....	190
9-05.9 Steel Spiral Rib Storm Sewer Pipe (RC)	191
9-05.12 Polyvinyl Chloride (PVC) Pipe	191
9-05.14 ABS Composite Sewer Pipe.....	192
9-05.17 Aluminum Spiral Rib Storm Sewer Pipe	192
9-05.24 Polypropylene Culvert Pipe, Polypropylene Storm Sewer Pipe, and Polypropylene Sanitary Sewer Pipe	193
9-05.24(1) Polypropylene Culvert Pipe and Storm Sewer Pipe	193
9-08 PAINTS	194
9-08.8 Manhole Coating System Products.....	194
9-08.8(1) Coating Systems Specification	194
9-14 EROSION CONTROL AND ROADSIDE PLANTING.....	194
9-14.1(1) Topsoil Type A	194
9-14.6(8) Sod.....	195
9-23 CONCRETE CURING MATERIALS AND ADMIXTURES.....	195
9-23.9 Fly Ash (RC)	195
9-30 WATER DISTRIBUTION MATERIALS	195
9-30.1 Pipe	195
9-30.1(1) Ductile Iron Pipe	195
9-30.1(2) Polyethylene Encasement	196
9-30.2 Fittings.....	196
9-30.2(1) Ductile Iron Pipe	196
9-30.2(2) Galvanized Iron Pipe	197
9-30.2(3) Steel Casing Pipe	197
9-30.2(4) Spacers and Seals for Steel Casing Pipe.....	197
9-30.2(6) Restrained Joint	198
9-30.2(6) Restrained Joint Pipe and Fittings	198
9-30.2(7) Bolted, Sleeve-Type Couplings for Plain End Pipe	198
9-30.3 Valves.....	198
9-30.3(1) Gate Valves (3 inches to 16 inches).....	199
9-30.3(3) Butterfly Valves.....	199
9-30.3(4) Valve Boxes.....	200
9-30.3(5) Valve Marker Posts.....	200
9-30.3(6) Valve Stem Extensions	200
9-30.3(7) Combination Air Release/Air Vacuum Valves	200

9-30.3(8) Tapping Sleeve and Valve Assembly	200
9-30.3(9) Blow-Off Assembly.....	200
9-30.5 Hydrants	201
9-30.5(1) End Connections	201
9-30.5(2) Hydrant Dimensions.....	201
9-30.6 Water Service Connections (2 Inches and Smaller)	202
9-30.6(3) Service Pipes	202
9-30.6(3)B Polyethylene Pipe	202
9-30.6(4) Service Fittings.....	202
9-30.6(5) Meter Setters.....	202
9-30.6(7) Meter Boxes	202
10 Removal of Utility Locate Markings From Sidewalks Required	202

SPECIAL PROVISIONS

The work on this project shall be accomplished in accordance with the Standard Specifications for Road, Bridge and Municipal Construction, 2020 edition, as issued by the Washington State Department of Transportation (WSDOT) and the American Public Works Association (APWA), Washington State Chapter (hereafter "Standard Specifications") The Standard Specifications, as modified or supplemented by the Amendments to the Standard Specifications and these Special Provisions, all of which are made a part of the Contract Documents, shall govern all of the Work.

These Special Provisions are made up of both General Special Provisions (GSPs) from various sources, which may have project-specific fill-ins; and project-specific Special Provisions. Each Provision either supplements, modifies, or replaces the comparable Standard Specification, or is a new Provision. The deletion, amendment, alteration, or addition to any subsection or portion of the Standard Specifications is meant to pertain only to that particular portion of the section, and in no way should it be interpreted that the balance of the section does not apply.

Also incorporated into the Contract Documents by reference are:

- Manual on Uniform Traffic Control Devices for Streets and Highways, currently adopted edition, with Washington State modifications, if any
- Standard Plans for Road, Bridge and Municipal Construction, WSDOT/APWA, current edition
- City of Renton Standard Plans, City of Renton Public Works Department, Current Edition
- Public Rights-Of-Way Accessibility Guidelines (PROWAG), current edition

Contractor shall obtain copies of these publications, at Contractor's own expense.

1-01 DEFINITIONS AND TERMS

1-01.1 General

Section 1-01.1 is supplemented with the following:

(*****)

Whenever reference is made to the State, State of Washington, Commission, Department of Transportation, Secretary of Transportation, Owner, Contracting Agency or Engineer, such reference shall be deemed to mean the City of Renton acting through its City Council, employees, and duly authorized representatives for all contracts administered by the City of Renton.

All references to "State Materials Laboratory" shall be revised to read "Contracting Agency designated location".

1-01.3 Definitions

Section 1-01.3 is revised and supplemented with the following:

(*****)

Act of God

"Act of God" means an earthquake, flood, cyclone, or other cataclysmic phenomenon of nature. A rain, windstorm, high water or other natural phenomenon of unusual intensity for the specific locality of the Work, which might reasonably have been anticipated from historical records of the general locality of the Work, shall not be construed as an act of God.

Consulting Engineer

The Contracting Agency's design consultant, who may or may not administer the construction program for the Contracting Agency.

Contract Documents

See definition for "Contract".

Contract Price

Either the unit price, the unit prices, or lump sum price or prices named in the proposal, or in properly executed change orders.

Contract Time

The period of time established by the terms and conditions of the Contract within which the Work must be physically completed.

Dates

Bid Opening Date: The date on which the Contracting Agency publicly opens and reads the bids.

Award Date: The date of the formal decision of the Contracting Agency to accept the lowest responsible and responsive Bidder for the Work.

Contract Execution Date: The date the Contracting Agency officially binds the agency to the Contract.

Notice to Proceed Date: The date stated in the Notice to Proceed on which the Contract Time begins.

Substantial Completion Date: The day the Engineer determines the Contracting Agency has full and unrestricted use and benefit of the facilities, both from the operational and safety standpoint, and only minor incidental Work, replacement of temporary substitute facilities, or correction or repair remains for the physical completion of the total contract.

Contract Completion Date: The date by which the Work is contractually required to be physically completed. The Contract Completion Date will be stated in the Notice to Proceed. Revisions of this date will be authorized in writing by the Engineer whenever there is an extension to the Contract time.

Completion Date: The day all the Work specified in the Contract is completed and all the obligations of the Contractor under the Contract are fulfilled by the Contractor.

Final Acceptance Date: The date the Contracting Agency accepts the Work as complete per the Contract requirements.

Day

Unless otherwise designated, day(s) as used in the Contract Documents, shall be understood to mean working days.

Engineer

The City Engineer or duly authorized representative, or an authorized member of a licensed consulting firm retained by the Contracting Agency for the construction engineering of a specific public works project.

Inspector

The Contracting Agency's authorized representative assigned to make necessary observations of the Work performed or being performed, or of materials furnished or being furnished by the Contractor.

Notice of Award: The written notice from the Contracting Agency to the successful bidder signifying the Contracting Agency's acceptance of the bid.

Notice to Proceed: The written notice from the Contracting Agency or the Engineer to the Contractor authorizing and directing the Contractor to proceed with Work and establishing the date on which the Contract time begins.

Or Equal

Where the term "or equal" is used herein, the Contracting Agency, or the Contracting Agency on recommendation of the Engineer, shall be the sole judge of the quality and suitability of the proposed substitution. The responsibility and cost of furnishing necessary evidence, demonstrations, or other information required to obtain the approval of alternative materials or processes by the Contracting Agency shall be entirely borne by the Contractor.

Owner

The City of Renton or its authorized representative also referred to as Contracting Agency.

Performance and Payment Bond

Same as "Contract Bond" defined in the Standard Specifications.

Plans

The Contract Plans and/or Standard Plans which show location, character, and dimensions of prescribed Work including layouts, profiles, cross-sections, and other details. Drawings may either be bound in the same book as the balance of the Contract Documents or bound in separate sets, and are a part of the Contract Documents, regardless of the method of binding. The terms "Standard Drawings" or "Standard Plans" generally used in Specifications refers to drawings bound either with the specification documents or included with the Plans or the City of Renton Standard Plans.

Points

Wherever reference is made to the Engineer's points, this shall mean all marks, bench marks, reference points, stakes, hubs, tack, etc., established by the Engineer for maintaining horizontal and vertical control of the Work.

Provide

Means "furnish and install" as specified and shown in the Plans.

Secretary, Secretary of Transportation

The chief executive officer of the Department and other authorized representatives. The chief executive officer to the Department shall also refer to the Department of Public Works Administrator.

Shop Drawings

Same as "Working Drawings" defined in the Standard Specifications.

Special Provisions

Modifications to the Standard Specifications and their amendments that apply to an individual project. The special provisions may describe Work the Specifications do not cover. Such Work shall comply first with the Special Provisions and then with any Specifications that apply. The Contractor shall include all costs of doing this Work within the bid prices.

State

The state of Washington acting through its representatives. The State shall also refer to The City of Renton and its authorized representatives where applicable.

Supplemental Drawings and Instructions

Additional instructions by the Engineer at request of the Contractor by means of drawings or documents necessary, in the opinion of the Engineer, for the proper execution of the Work. Such drawings and instructions are consistent with the Contract Documents.

Traffic

Both vehicular and non-vehicular traffic, such as pedestrians, bicyclists, wheelchairs, and equestrian traffic.

Utility

Public or private fixed improvement for the transportation of fluids, gases, power, signals, or communications and shall be understood to include tracks, overhead and underground wires, cables, pipelines, conduits, ducts, sewers, or storm drains.

1-02 BID PROCEDURES AND CONDITIONS

1-02.1 Prequalification of Bidders

Delete this Section and replace it with the following:

(*****)

Bidders shall be qualified by experience, financing, equipment, and organization to do the Work called for in the Contract Documents. The Contracting Agency reserves the right to take whatever action it deems necessary to ascertain the ability of the bidder to perform the Work satisfactorily.

1-02.2 Plans and Specifications

Delete this Section and replace it with the following:

(*****)

Information as to where Bid Documents can be obtained or reviewed will be found in the Call for Bids (Advertisement for Bids) for the Work.

After award of the Contract, Plans and Specifications will be issued to the Contractor at no cost as detailed below:

To Prime Contractor	No. of Sets	Basis of Distribution
Reduced Plans (11" x 17") and contract provisions	4	Furnished automatically upon award
Large Plans (22" x 34")	4	Furnished only upon request

Additional Plans and Contract Provisions may be purchased by the Contractor by payment of the cost stated in the Call for Bids.

1-02.4(2) Subsurface Information

Section 1-02.4(2) is supplemented with the following:

(*****)

If a geotechnical study was prepared for the project, then the findings and recommendations are summarized in a report that upon request, may be obtained from the City of Renton.

1-02.5 Proposal Forms

Delete this Section and replace it with the following:

(*****)

At the request of the bidder, the Contracting Agency will provide a proposal form for any project on which the bidder is eligible to bid.

The proposal form will identify the project and its location and describe the Work. It will also list estimated quantities, units of measurement, the items of Work, and the materials to be furnished at the unit bid prices. The bidder shall complete spaces on the proposal form that call for, but are not limited to, unit bid prices; extensions; summations; the total bid amount; signatures; date; and, where applicable, retail sales taxes and acknowledgement of addenda; the bidder's name, address, telephone number, and signature; and a State of Washington Contractor's Registration Number. Bids shall be completed by typing or shall be printed in ink by hand, preferably in black ink. The required certifications are included as part of the proposal form.

The Contracting Agency reserves the right to arrange the proposal forms with alternates and additives, if such be to the advantage of the Contracting Agency. The bidder shall bid on all alternates and additives set forth in the proposal forms unless otherwise specified.

Any correction to a bid made by interlineations, alteration, or erasure, shall be initialed by the signer of the bid. The bidder shall make no stipulation on the Bid Form, nor qualify the bid in any manner.

A bid by a corporation shall be executed in the corporate name, by the president or a vice president (Or other corporate officer accompanied by evidence of authority to sign).

A bid by a partnership shall be executed in the partnership name and signed by a partner. A copy of the partnership agreement shall be submitted with the Bid Form if any D/M/WBE requirements are to be satisfied through such an agreement.

A bid by a joint venture shall be executed in the joint venture name and signed by a member of the joint venture. A copy of the joint venture agreement shall be submitted with the Bid Form if any D/W/MBE requirements are to be satisfied through such an agreement.

1-02.6 Preparation of Proposal

Section 1-02.6 is supplemented with the following:

Supplement the second paragraph with the following:

(*****)

4. If a minimum bid amount has been established for any item, the unit or lump sum price must equal or exceed the minimum amount stated.
5. Any correction to a bid made by interlineation, alteration, or erasure, shall be initialed by the signer of the bid.

Delete the last paragraph, and replace it with the following:

The Bidder shall make no stipulation on the Bid Form, nor qualify the bid in any manner.

A bid by a corporation shall be executed in the corporate name, by the president or a vice president (or other corporate officer accompanied by evidence of authority to sign).

A bid by a partnership shall be executed in the partnership name and signed by a partner. A copy of the partnership agreement shall be submitted with the Bid Form if any D/M/WBE requirements are to be satisfied through such an agreement.

A bid by a joint venture shall be executed in the joint venture name and signed by a member of the joint venture. A copy of the joint venture agreement shall be submitted with the Bid Form if any D/W/MBE requirements are to be satisfied through such an agreement.

1-02.6(1) Proprietary Information

1-02.6(1) is a new Section.

(*****)

Vendors should, in the bid proposal, identify clearly any material(s), which constitute "(valuable) formula, designs drawings, and research data" so as to be exempt from public disclosure, RCW 42.56.210, or any materials otherwise claimed to be exempt, along with a Statement of the basis for such claim of exemption. The Department (or State) will give notice to the vendor of any request for disclosure of such information received within 5 (five) years from the date of submission. Failure to so label such materials or failure to timely respond after notice of request for public disclosure has been given shall be deemed a waiver by the submitting vendor of any claim that such materials are, in fact, so exempt.

1-02.7 Bid Deposit

Section 1-02.7 is supplemented with the following:

(*****)

Bid Bonds shall contain the following:

1. Number assigned to the project by the Contracting Agency;
2. Name of the project;
3. The Contracting Agency named as obligee;
4. The amount of the bid bond stated either as a dollar figure or as a percentage which represents five percent of the maximum bid amount that could be awarded;
5. Signature of the bidder's officer empowered to sign official statements. The signature of the person authorized to submit the bid should agree with the signature on the bond, and the title of the person must accompany said signature;
6. The signature of the surety's officer empowered to sign the bond form included in the Contract Provision.

1-02.9 Delivery of Proposal

Replace first paragraph with:

(*****)

Each proposal shall be submitted in a sealed envelope, with Project Name and Project Number clearly marked on the outside of the envelope as stated in the Call for Bids, or as otherwise stated in the Bid Documents.

1-02.12 Public Opening of Proposals

Section 1-02.12 is supplemented with the following:

(*****)

The Contracting Agency reserves the right to postpone the date and time for bid opening. Notification to bidder will be by addenda.

1-02.13 Irregular Proposals

Revise item 1 to read:

(*****)

1. A proposal will be considered irregular and will be rejected if:
 - a. The bidder is not prequalified when so required;
 - b. The authorized proposal form furnished by the Contracting Agency is not used or is altered;
 - c. The complete proposal form contains any unauthorized additions, deletions, alternate bids, or conditions;
 - d. The bidder adds provisions reserving the right to reject or accept the award, or enter into the Contract;
 - e. A price per unit cannot be determined from the bid proposal;
 - f. The proposal form is not properly executed;
 - g. The bidder fails to submit or properly complete a subcontractor list, if applicable, as required in Section 1-02.6
 - h. The bidder fails to submit or properly complete a Disadvantaged, Minority or Women's Business Enterprise Certification, if applicable, as required in Section 1-02.6; or
 - i. The bid proposal does not constitute a definite and unqualified offer to meet the material terms of the bid invitation.
 - j. More than one proposal is submitted for the same project from a Bidder under the same or different names.

1-02.14 Disqualification of Bidders

Delete this section in its entirety and replace with the following:

(*****)

1. A bidder will be deemed not responsible and the proposal rejected if the bidder does not meet the responsibility criteria in RCW 39.04.
2. A bidder may be deemed not responsible and the proposal rejected if:
 - a. More than one proposal is submitted for the same project from a bidder under the same or different names;
 - b. Evidence of collusion exists with any other bidder or potential bidder. Participants in collusion will be restricted from submitting further bids;
 - c. The bidder, in the opinion of the Contracting Agency, is not qualified for the Work or to the full extent of the bid, or to the extent that the bid exceeds the authorized

prequalification amount as may have been determined by a prequalification of the bidder;

- d. An unsatisfactory performance record exists based on past or current Contracting Agency Work or for Work done for others, as judged from the standpoint of conduct of the Work; workmanship; progress; affirmative action; equal employment opportunity practices; or Disadvantaged Enterprise, Minority Enterprise, or Women's Business Enterprise utilization.
- e. There is uncompleted Work (Contracting Agency or otherwise) which might hinder or prevent the prompt completion of the Work bid upon;
- f. The bidder failed to settle bills for labor or materials on past or current contracts;
- g. The bidder has failed to complete a written public contract or has been convicted of a crime arising from a previous public contract;
- h. The bidder is unable, financially or otherwise, to perform the Work;
- i. A bidder is not authorized to do business in the State of Washington (not registered in accordance with RCW 18.27)
- j. There are any other reasons deemed proper by the Contracting Agency.

1-02.15 Pre Award Information

Revise this section to read:

(*****)

Before awarding any contract, the Contracting Agency may require one or more of these items or actions of:

1. A complete statement of the origin, composition, and manufacture of any or all materials to be used;
2. Samples of these materials for quality and fitness tests;
3. A progress schedule (in a form the Contracting Agency requires) showing the order of time required for the various phases of Work;
4. A breakdown of costs assigned to any bid item;
5. Attendance at a conference with the Engineer or representatives of the Engineer;
6. Obtain, and furnish a copy of, a business license to do business in the city and/or county where the Work is located;
7. A copy of State of Washington Contractor's Registration; or
8. Any other information or action taken that is deemed necessary to ensure that the bidder is the lowest responsible bidder.

1-03 AWARD AND EXECUTION OF CONTRACT

1-03.1 Consideration of bids

Section 1-03.1 is supplemented with the following:

(*****)

All bids will be based on total sum of all schedules of prices. No partial bids will be accepted unless so stated in the call for bids or special provisions. The City reserves the right to award all or any schedule of a bid to the lowest bidder at its discretion.

1-03.2 Award of Contract

Section 1-03.2 is supplemented with the following:

(*****)

The Contract, bond form, and all other forms requiring execution, together with a list of all other forms or documents required to be submitted by the successful bidder, will be forwarded to the successful bidder within 10 days of the award. The number of copies to be executed by the Contractor shall be determined by the Contracting Agency.

1-03.3 Execution of Contract

Section 1-03.3 is revised and supplemented with the following:

(*****)

Within 10 calendar days after receipt from the City of the forms and documents required to be completed by the Contractor, the successful bidder shall return the signed Contracting Agency-prepared contract, an insurance certification as required by Section 1-07.18, and a satisfactory bond as required by law and Section 1-03.4. Before execution of the Contract by the Contracting Agency, the successful bidder shall provide any pre-award information the Contracting Agency may require under Section 1-02.15.

Until the Contracting Agency executes a contract, no proposal shall bind the Contracting Agency nor shall any Work begin within the project limits or within Contracting Agency-furnished sites. The Contractor shall bear all risks for any Work begun outside such areas and for any materials ordered before the Contract is executed by the Contracting Agency.

If the bidder experiences circumstances beyond their control that prevents return of the Contract documents within 10 calendar days after the award date, the Contracting Agency may grant up to a maximum of 10 additional calendar days for return of the documents, provided the Contracting Agency deems the circumstances warrant it.

The Contracting Agency is prohibited by RCW 39.06.010 from executing a contract with a Contractor who is not registered or licensed as required by the laws of the state. In addition, the Contracting Agency requires persons doing business with the Contracting Agency to possess a valid City of Renton business license prior to award.

When the Bid Form provides spaces for a business license number, a Washington State Contractors registration number, or both, the Bidder shall insert such information in the spaces provided. The Contracting Agency requires legible copies of the Contractor's Registration and business license be submitted to the Engineer as part of the Contracting Agency's post-award information and evaluation activities.

1-03.4 Contract Bond

Revise the first paragraph to read:

(*****)

The successful bidder shall provide an executed contract bond for the full contract amount. This contract bond shall:

1. Be on the Contracting Agency-furnished form;
2. Be signed by an approved surety (or sureties) that:
 - a. Is registered with the Washington State Insurance Commissioner, and

- b. Appears on the current Authorized Insurance List in the State of Washington published by the Office of the Insurance Commissioner;
3. Be conditioned upon the faithful performance of the Contract by the Contractor within the prescribed time;
4. Guarantee that the surety shall indemnify, defend, and protect the Contracting Agency against any claim of direct or indirect loss resulting from the failure:
 - a. Of the Contractor (or any of the employees, subcontractors, or lower tier subcontractors of the Contractor) to faithfully perform the Contract, or
 - b. Of the Contractor (subcontractors, or lower tier subcontractors of the Contractor) to pay all laborers, mechanics, subcontractors, lower tier subcontractors, material person, or any other person who provides supplies or provisions for carrying out Work;
5. Be accompanied by a power of attorney for the Surety's officer empowered to sign the bond; and
6. Be signed by an officer of the Contractor empowered to sign official statements (sole proprietor or partner). If the Contractor is a corporation, the bond must be signed by the president or vice-president, unless accompanied by a written proof of the authority of the individual signing the bond to bind the corporation (i.e., corporate resolution, power of attorney or a letter to such effect by the president or vice-president).

1-03.7 Judicial Review

Revise the last sentence to read:

(*****)

The venue of all causes of action arising from the advertisement, award, execution, and performance of the Contract shall be in the Superior Court of the County where the Contracting Agency's headquarters are located.

1-04 SCOPE OF WORK

1-04.2 Coordination of Contract Documents, Plans, Special Provisions Specifications, and Addenda

Revise the second paragraph to read:

(*****)

Any inconsistency in the parts of the Contract shall be resolved by following this order of precedence (e.g., 1 presiding over 2, 2 over 3, 3 over 4, and so forth):

1. Addenda
2. Proposal Form
3. Special Provisions
4. Contract Plans
5. Contracting Agency's Standard Plans (if any)
6. Amendments to the Standard Specifications
7. WSDOT/APWA Standard Specifications for Road, Bridge and Municipal Construction
8. WSDOT/APWA Standard Plans for Road, Bridge and Municipal Construction

1-04.8 Progress Estimates and Payments

Section 1-04.8 is supplemented with the following:

(*****)

Prior to progress payments, the Contractor is encouraged to provide to the Engineer an estimate of "Lump Sum" Work accomplished to date. The Engineer's calculations and decisions shall be final in regard to the actual percentage of any lump sum pay item accomplished and eligible for payment unless another specific method of calculating lump sum payments is provided elsewhere in the Specifications.

1-04.11 Final Cleanup

Section 1-04.11 is supplemented with the following:

(*****)

All salvage material as noted on the Plans and taken from any of the discarded facilities shall, at the Engineer's discretion, be carefully salvaged and delivered to the City shops. Any cost incurred in salvaging and delivering such items shall be considered incidental to the project and no compensation will be made.

The Contract price for "Finish and Cleanup, Lump Sum," shall be full compensation for all Work, equipment and materials required to perform final cleanup. If this pay item does not appear in the Contract Documents then final cleanup shall be considered incidental to the Contract and to other pay item and no further compensation shall be made.

1-04.12 Contractor-Discovered Discrepancies

Section 1-04.12 is a new section:

(*****)

Upon receipt of award of contract, the Contractor shall carefully study and compare all the components of the Contract Documents and other instructions, and check and verify all field measurements. The Contractor shall, prior to ordering material or performing Work, report in writing to the Engineer any error, inconsistency, or omission with respect to design or mode of construction, which is discovered. If the Contractor, in the course of this study or in the accomplishment of the Work, finds any discrepancy between the Plans and the physical condition of the locality as represented in the Plans, or any such errors or omissions with respect to design or mode of construction in the Plans or in the layout as given by points and instructions, it shall be the Contractor's duty to inform the Engineer immediately in writing, and the Engineer will promptly check the same. Any Work done after such discovery, until correction of Plans or authorization of extra Work is given, if the Engineer finds that extra Work is involved, will be done at the Contractor's risk. If extra Work is involved, the procedure shall be as provided in Section 1-04.4 of the Standard Specifications.

1-05 CONTROL OF WORK

1-05.4 Conformity With and Deviation from Plans and Stakes

Section 1-05.4 is supplemented with the following:

(*****)

If the project calls for the Contractor supplied surveying, the Contractor shall provide all required survey Work, including such Work as mentioned in Sections 1-05, 1-11 and elsewhere in these

Specifications as being provided by the Engineer. All costs for this survey Work shall be included in "Contractor Supplied Surveying," per lump sum.

The Engineer or the Contractor supplied surveyor will provide construction stakes and marks establishing lines, slopes, and grades as stipulated in this section and will perform such Work per Section 1-11. The Contractor shall assume full responsibility for detailed dimensions, elevations, and excavation slopes measured from the Engineer or the Contractor supplied surveyor furnished stakes and marks.

The Contractor shall provide a work site, which has been prepared to permit construction staking to proceed in a safe and orderly manner. The Contractor shall keep the Engineer or the Contractor supplied surveyor informed of staking requirements and provide at least 48 hour notice to allow the Engineer or the Contractor supplied surveyor adequate time for setting stakes.

The Contractor shall carefully preserve stakes, marks, and other reference points, including existing monumentation, set by Contracting Agency forces. The Contractor will be charged for the costs of replacing stakes, markers and monumentation that were not to be disturbed but were destroyed or damaged by the Contractor's operations. This charge will be deducted from monies due or to become due to the Contractor.

Any claim by the Contractor for extra compensation by reason of alterations or reconstruction Work allegedly due to error in the Engineer's line and grade, will not be allowed unless the original control points set by the Engineer still exist, or unless other satisfactory substantiating evidence to prove the error was furnished by the Engineer. Three consecutive points set on line or grade shall be the minimum points used to determine any variation from a straight line or grade. Any such variation shall, upon discovery, be reported to the Engineer. In the absence of such report the Contractor shall be liable for any error in alignment or grade.

The Contractor shall provide all surveys required other than those to be performed by the Engineer. All survey Work shall be done in accordance with Section 1-11 SURVEYING STANDARDS of these Specifications.

The Contractor shall keep updated survey field notes in a standard field book and in a format set by the Engineer, per Section 1-11.1(4). These field notes shall include all survey Work performed by the Contractor's surveyor in establishing line, grade and slopes for the construction Work. Copies of these field notes shall be provided to the Engineer upon request and upon completion of the Contract Work the field book or books shall be submitted to the Engineer and become the property of the Contracting Agency.

If the survey Work provided by the Contractor does not meet the standards of the Engineer, then the Contractor shall, upon the Engineer's written request, remove the individual or individuals doing the survey Work and the survey Work will be completed by the Engineer at the Contractor's expense. Costs for completing the survey Work required by the Engineer will be deducted from monies due or to become due the Contractor.

All costs for survey Work required to be performed by the Contractor shall be included in the prices bid for the various items which comprise the improvement or be included in the bid item for "Contractor Supplied Surveying" per lump sum if that item is included in the contracts.

1-05.4(1) Contractor Supplied Surveying

Section 1-05.4(1) is a new section:

(*****)

When the Contract provides for Contractor Supplied Surveying, the Contractor shall supply the survey Work required for the project. The Contractor shall retain as a part of the Contractor Organization an experienced team of surveyors under the direct supervision of a professional land surveyor licensed by the State of Washington. All survey Work shall be done in accordance with Sections 1-05.4 and 1-11.

The Contractor and/or the Surveyor shall inform the Engineer in writing of any errors, discrepancies, and omissions to the Plans that prevent the Contractor and/or the Surveyor from constructing the project in a manner satisfactory to the Engineer. All errors, discrepancies, and omissions must be corrected to the satisfaction of the Engineer before the survey Work may be continued.

The Contractor shall coordinate his Work with the Surveyor and perform his operations in a manner to protect all survey stakes from harm. The Contractor shall inform the Surveyor of the Contractor's intent to remove any survey stakes and/or points before physically removing them.

The Surveyor shall be responsible for providing As-Built Information for the project. The Contractor shall coordinate his operations and assist the Surveyor in maintaining accurate As-Built Information for the project.

If the Contractor and the Surveyor fail to provide, as directed by the Engineer and/or these Plans and Specifications, accurate As-Built Information and other Work the Engineer deems necessary, the Engineer may elect to provide at Contractor expense, a surveyor to provide all As-Built Information and other Work as directed by the Engineer. The Engineer shall deduct expenses incurred by the Engineer-supplied surveying from monies owed to the Contractor.

Payment per Section 1-04.1 for all Work and materials required for the full and complete survey Work required to complete the project and provide As-Built Information shall be included in the lump sum price for "Construction Surveying, Staking, and As-Built Information."

1-05.4(2) Contractor Provided As-Built Information

Section 1-05.4(2) is a new section:

(*****)

Prior to the backfilling of the trenches It shall be the Contractors responsibility to record the location, by centerline station, offset, and depth below pavement, of all existing utilities uncovered or crossed during his Work as covered under this project.

It shall be the Contractor's responsibility to have his Surveyor locate each major item of Work done under this contract per the survey standard of Section 1-11. Major items of Work shall include but not be limited to: Manholes, Catch basins and Inlets, Valves, vertical and Horizontal Bends, Junction boxes, Cleanouts, Side Sewers, Street Lights & Standards, Hydrants, Major Changes in Design Grade, Vaults, Culverts, Signal Poles, and Electrical Cabinets.

After the completion of the Work covered by this contract, the Contractor's Surveyor shall provide to the City electronic files , both AutoCad and pdf files of the project drawings, containing the surveyor's

as-built information and one set of white prints of the project drawings upon which he has plotted the notes of the Contractor locating existing utilities. This drawing shall bear the Surveyor's seal and signature certifying its accuracy.

All costs for as-built Work shall be included in the Contract item "Construction Surveying, Staking, and As-Built Information", lump sum.

1-05.7 Removal of Defective and/or Unauthorized Work

Section 1-05.7 is supplemented with the following:

(*****)

Upon written notice from the Engineer, the Contractor shall promptly replace and re-execute Work by Contractor forces, in accordance with the intent of the Contract and without expense to the Contracting Agency, and shall bear the expense of making good all Work of other contractors destroyed or damaged by such removal or replacement.

If the Contractor does not remove such condemned Work and materials and commence re-execution of the Work within 7 calendar days of written notice from the Engineer, or fails to perform any part of the Work required by the Contract Documents, the Contracting Agency may correct and remedy such Work as may be identified in the written notice, with Contracting Agency forces or by such other means as the Contracting Agency may deem necessary. In that case, the Contracting Agency may store removed material.

Direct or indirect costs incurred by the Contracting Agency attributable to correcting and remedying defective or unauthorized Work, or Work the Contractor failed or refused to perform, shall be paid by the Contractor. Payment will be deducted by the Engineer from monies due, or to become due, the Contractor. Such direct and indirect costs shall include in particular, but without limitation, compensation for additional professional services required, and costs for repair and replacement of Work of others destroyed or damaged by correction, removal, or replacement of the Contractor's unauthorized Work.

If sufficient funds do not remain in the Contract and the Contractor does not pay the cost of such removal and storage within 10 calendar days from the date of the notice to the Contractor of the fact of such removal, the Contracting Agency may, upon an additional 10 calendar days written notice, sell such materials at public or private sale, and deduct all costs and expenses incurred from monies due to the Contractor, including costs of sale, and accounting to Contractor for the net proceeds remaining. The Contracting Agency may bid at any such sale. The Contractor shall be liable to the Contracting Agency for the amount of any deficiency from any funds otherwise due the Contractor.

If the Contractor fails to comply with a written order to remedy what the Engineer determines to be an emergency situation, the Engineer may have the defective and unauthorized Work corrected immediately, have the rejected Work removed and replaced, or have Work the Contractor refuses to perform completed by using Contracting Agency or other forces. An emergency situation is any situation when, in the opinion of the Engineer, a delay in its remedy could be potentially unsafe, or might cause serious risk of loss or damage to the public, the Property Owner and the Property Owner's property.

No adjustment in contract time or compensation will be allowed because of the delay in the performance of the Work attributable to the exercise of the Contracting Agency's rights provided by this section.

The rights exercised under the provisions of this section shall not diminish the Contracting Agency's right to pursue any other avenue for additional remedy or damages with respect to the Contractor's failure to perform the Work as required.

1-05.10 Guarantees

Section 1-05.10 is supplemented with the following:

(*****)

If within one year after the Acceptance Date of the Work by the Contracting Agency, defective and/or unauthorized Work is discovered, the Contractor shall promptly, upon written order by the Contracting Agency, return and in accordance with the Engineer's instructions, either correct such Work, or if such Work has been rejected by the Engineer, remove it from the project site and replace it with non-defective and authorized Work, all without cost to the Contracting Agency. If the Contractor does not promptly comply with the written order to correct defective and/or unauthorized Work, or if an emergency exists, the Contracting Agency reserves the right to have defective and/or unauthorized Work corrected or removed and replaced pursuant to Section 1-05.7 "Removal of Defective and/or Unauthorized Work."

The Contractor agrees the above one year limitation shall not exclude or diminish the Contracting Agency's rights under any law to obtain damages and recover costs resulting from defective and/or unauthorized Work discovered after one year but prior to the expiration of the legal time period set forth in RCW 4.16.040.

The Contractor shall warrant good title to all materials, supplies, and equipment purchased for, or incorporated in the Work. Nothing contained in this paragraph, however, shall defeat or impair the right of persons furnishing materials or labor, to recover under any bond given by the Contractor for their protection, or any rights under any law permitting such persons to look to funds due the Contractor in the hands of the Contracting Agency.

The provisions of this paragraph shall be inserted in all subcontracts and material contracts, and notice of its provisions shall be given to all persons furnishing materials for the Work when no formal contract is entered into for such materials.

1-05.11 Final Inspection

1-05.11(1) Substantial Completion Date

Section 1-05.11(1) is a new section:

(*****)

When the Contractor considers the Work to be substantially complete, the Contractor shall so notify the Engineer and request the Engineer establish the Substantial Completion Date. The Engineer will schedule an inspection of the Work with the Contractor to determine the status of completion.

To be considered substantially complete the following conditions must be met:

1. The Contracting Agency must have full and unrestricted use and benefit of the facilities both from the operational and safety standpoint.
2. Only minor incidental Work, replacement of temporary substitute facilities, or correction of repair Work remains to reach physical completion of the Work.

The Contractor's request shall list the specific items of Work in subparagraph two above that remains to be completed in order to reach physical completion. The Engineer may also establish the Substantial Completion Date unilaterally.

If after this inspection, the Engineer concurs with the Contractor that the Work is substantially complete and ready for its intended use, the Engineer, by written notice to the Contractor, will set the Substantial Completion Date. If, after this inspection the Engineer does not consider the Work substantially complete and ready for its intended use, the Engineer will, by written notice, so notify the Contractor giving the reasons therefore.

Upon receipt of written notice concurring with or denying substantial completion, whichever is applicable, the Contractor shall pursue vigorously, diligently and without unauthorized interruption, the Work necessary to reach Substantial and Physical Completion. The Contractor shall provide the Engineer with a revised schedule indicating when the Contractor expects to reach substantial and physical completion of the Work.

The above process shall be repeated until the Engineer establishes the Substantial Completion Date and the Contractor considers the Work physically complete and ready for Final Inspection.

1-05.11(2) Final Inspection and Physical Completion Date

Section 1-05.11(2) is a new Section:

(*****)

When the Contractor considers the Work physically complete and ready for Final Inspection, the Contractor, by Written Notice, shall request the Engineer to schedule a final inspection. The Engineer will set a date for Final Inspection. The Engineer and the Contractor will then make a final inspection and the Engineer will notify the Contractor in writing of all particulars in which the Final Inspection reveals the Work incomplete or unacceptable. The Contractor shall immediately take such corrective measures as are necessary to remedy the listed deficiencies. Corrective Work shall be pursued vigorously, diligently, and without interruption until physical completion of the listed deficiencies. This process will continue until the Engineer is satisfied the listed deficiencies have been corrected.

If action to correct the listed deficiencies is not initiated within 7 days after receipt of the Written Notice listing the deficiencies, the Engineer may, upon Written Notice to the Contractor, take whatever steps are necessary to correct those deficiencies pursuant to Section 1-08.5. The Contractor will not be allowed an extension of contract time because of a delay in the performance of the Work attributable to the exercise of the Engineer's right hereunder.

Upon correction of all deficiencies, the Engineer will notify the Contractor and the Contracting Agency, in writing, of the date upon which the Work was considered physically complete, that date shall constitute the Physical Completion Date of the Contract, but shall not imply all the obligations of the Contractor under the Contract have been fulfilled.

1-05.11(3) Operational Testing

Section 1-05.11(3) is a new section:

(*****)

Unless otherwise noted in the Contract Documents, the Contractor shall give the Engineer a minimum of 3 working days' notice of the time for each test and inspection. If the inspection is by another authority than the Engineer, the Contractor shall give the Engineer a minimum of 3 working days' notice of the date fixed for such inspection. Required certificates of inspection by other authority than the Engineer shall be secured by the Contractor.

It is the intent of the Contracting Agency to have at the Physical Completion Date a complete and operable system. Therefore, when the Work involves the installation of machinery or other mechanical equipment; street lighting, electrical distribution or signal systems; irrigation systems; buildings; or other similar Work, it may be desirable for the Engineer to have the Contractor operate and test the Work for a period of time, after final inspection but prior to the physical completion date. Whenever items of Work are listed in the Contract Provisions for operational testing they shall be fully tested under operating conditions for the time period specified to ensure their acceptability prior to the Physical Completion Date. During and following the test period, the Contractor shall correct any items of workmanship, materials, or equipment which prove faulty, or that are not in first class operating condition. Equipment, electrical controls, meters, or other devices and equipment to be tested during this period shall be tested under the observation of the Engineer, so that the Engineer may determine their suitability for the purpose for which they were installed. The Physical Completion Date cannot be established until testing and corrections have been completed to the satisfaction of the Engineer.

The costs for power, gas, labor, material, supplies, and everything else needed to successfully complete operational testing, shall be included in the unit contract prices related to the system being tested, unless specifically set forth otherwise in the proposal.

Operational and test periods, when required by the Engineer, shall not affect a manufacturer's guaranties or warranties furnished under the terms of the Contract.

1-05.12 Final Acceptance

The third and fourth sentences in paragraph 1 are deleted and replaced with:

(*****)

The Final Acceptance date shall be that date in which the Renton City Council formally approves acceptance of the Work.

1-05.13 Superintendents, Labor and Equipment of Contractor

Revise the last paragraph to read:

(*****)

Whenever the Contracting Agency evaluates the Contractor's qualifications pursuant to Section 1-02.1, the Contracting Agency will take these performance reports into account.

1-05.14 Cooperation with Other Contractors

Section 1-05.14 is supplemented with the following:

(*****)

The Contractor shall afford the Contracting Agency and other contractors working in the area reasonable opportunity for the introduction and storage of their materials and the execution of their respective Work, and shall properly connect and coordinate the Contractor's Work with theirs.

Other utilities, districts, agencies, and contractors who may be working within the project area may include, but are not limited to:

1. Puget Sound Energy (gas and electric)
2. AT&T Broadband
3. CenturyLink
4. City of Renton (water, wastewater, surface water, transportation)
5. Comcast
6. Seattle Public Utilities
7. Soos Creek Sewer and Water District
8. Cedar River Sewer and Water District
9. Skyway Sewer and Water District
10. Coal Creek Sewer and Water District
11. Water District 90
12. Olympic Pipeline
13. Private contractors employed by adjacent property owners

1-05.16 Water and Power

Section 1-05.16 is a new Section:

(*****)

The Contractor shall make necessary arrangements and shall bear the costs for power and water necessary for the performance of the Work, unless the Contract includes power and water as a pay item.

1-05.17 Oral Agreements

Section 1-05.17 is a new section:

(*****)

No oral agreement or conversation with any officer, agent, or employee of the Contracting Agency, either before or after execution of the Contract, shall affect or modify any of the terms or obligations contained in any of the documents comprising the Contract. Such oral agreement or conversation shall be considered as unofficial information and in no way binding upon the Contracting Agency, unless subsequently put in writing and signed by the Contracting Agency.

1-05.18 Contractor's Daily Diary

Section 1-05.18 is a new section:

(*****)

The Contractor and subcontractors shall maintain and provide to the Engineer a Daily Diary Record of this Work. This diary will be created by pen entries in a hardbound diary book of the type that is commonly available through commercial outlets, or in a commonly-accepted electronic format. The diary must contain the Project and Number; if the diary is in loose-leaf form, this information must appear on every page. The diary must be kept and maintained by the Contractor's designated project

superintendent(s). Entries must be made on a daily basis and must accurately represent all of the project activities on each day.

At a minimum, the diary shall show on a daily basis:

1. The day and date.
2. The weather conditions, including changes throughout the day.
3. A complete description of Work accomplished during the day with adequate references to the Plans and Contract Provisions, so that the reader can easily and accurately identify said Work in the Plans. Identify location/description of photographs or videos taken that day.
4. An entry for each and every changed condition, dispute or potential dispute, incident, accident, or occurrence of any nature whatsoever which might affect the Contractor, the Contracting Agency, or any third party in any manner.
5. Listing of any materials received and stored on or off-site by the Contractor for future installation, to include the manner of storage and protection of the same.
6. Listing of materials installed during each day.
7. List of all subcontractors working on-site during each day.
8. Listing of the number of the Contractor's employees working during each day by category of employment.
9. Listing of the Contractor's equipment working on the site during each day. Idle equipment on the site shall be listed and designated as idle.
10. Notations to explain inspections, testing, stake-out, and all other services furnished by the Contracting Agency or other party during each day.
11. Entries to verify the daily (including non-Work days) inspection and maintenance of traffic control devices and condition of the traveled roadway surfaces. The Contractor shall not allow any conditions to develop that would be hazardous to the public.
12. Any other information that serves to give an accurate and complete record of the nature, quantity, and quality of Contractor's progress on each day.
13. Plan markups showing locations and dimensions of constructed features to be used by the Engineer to produce record drawings.
14. All pages of the diary must be numbered consecutively with no omissions in page numbers.
15. Each page must be signed and dated by the Contractor's official representative on the project.

The Contractor may use additional sheets separate from the diary book, if necessary, to provide a complete diary record, but they must be signed, dated, and labeled with project name and number.

It is expressly agreed between the Contractor and the Contracting Agency that the Daily Diary maintained by the Contractor shall be the "Contractor's Book of Original Entry" for the documentation of any potential claims or disputes that might arise during this contract. Failure of the Contractor to maintain this diary in the manner described above will constitute a waiver of any such claims or disputes by the Contractor.

The Engineer or other Contracting Agency's representative on the job site will also complete a Daily Construction Report.

1-06 CONTROL OF MATERIAL

1-06.1 Approval of Materials Prior to Use

Section 1-06.1 is supplemented with the following:

(*****)

The materials and equipment lists submitted to the Engineer at the Preconstruction Conference shall include the quantity, manufacturer, and model number, if applicable, of materials and equipment to be installed under the Contract. This list will be checked by the Engineer as to conformity with the Contract Documents. The Engineer will review the lists within 10 working days, noting required corrections. The Contractor shall make required corrections and file 2 corrected copies with the Engineer within one week after receipt of required corrections. The Engineer's review and acceptance of the lists shall not relieve the Contractor from responsibility for suitability for the intended purpose, nor for deviations from the Contract Documents.

1-06.2(1) Samples and Tests for Acceptance

Section 1-06.2(1) is supplemented with the following:

(*****)

The finished Work shall be in accordance with approved samples. Approval of samples by the Engineer does not relieve the Contractor of responsibility for performance of the Work in accordance with the Contract Documents.

1-06.2(2) Statistical Evaluation of Materials for Acceptance

Section 1-06.2(2) is supplemented by with the following:

(*****)

Unless stated otherwise in the special provisions, statistical evaluation will not be used by the City of Renton.

1-07 LEGAL RELATIONS AND RESPONSIBILITIES TO THE PUBLIC

1-07.1 Laws to be Observed

Section 1-07.1 is supplemented with the following:

(*****)

The Contractor shall erect and properly maintain, at all times, as required by the conditions and progress of the Work, all necessary safeguards for protection of workers and the public; shall post danger signs warning against known or unusual hazards; and shall designate as Safety Supervisor, a responsible employee on the construction site whose duty shall be the enforcement of safety. The name and position of such person so designated shall be reported in writing to the Engineer by the Contractor.

The Contractor shall, at all times, enforce strict discipline and good order among all employees and shall not employ any person unfit or not skilled in the Work assigned to him/her.

Necessary sanitation conveniences for the use of the workers on the job, properly secluded from public observation, shall be provided and maintained by the Contractor.

In cases of conflict between different safety regulations, the more stringent regulation shall apply.

The Washington State Department of Labor and Industries shall be the sole and paramount administrative agency responsible for the administration of the provisions of the Washington Industrial Safety and Health Act of 1973 (WISHA).

The Contractor shall maintain at the project site office, or other well-known place at the project site, all articles necessary for providing first aid to the injured. The Contractor shall establish, publish, and make known to all employees, procedures for ensuring immediate removal to a hospital or doctor's care, and persons, including employees, who may have been injured on the project site. Employees should not be permitted to Work on the project site before the Contractor has established and made known procedures for removal of injured persons to a hospital or a doctor's care.

The Contractor shall have sole responsibility for the safety, efficiency, and adequacy of the Contractor's plant, appliances, and methods, and for any damage or injury resulting from their failure, or improper maintenance, use, or operation. The Contractor shall be solely and completely responsible for the conditions of the project site, including safety for all persons and property in the performance of the Work. This requirement shall apply continuously, and not be limited to normal working hours. The required or implied duty of the Engineer to conduct construction review of the Contractor's performance does not, and shall not, be intended to include review and adequacy of the Contractor's safety measures, in, on, or near the project site.

1-07.6 Permits and Licenses

Section 1-07.6 is supplemented with the following:

(*****)

The Contractor shall ensure that all necessary permits are obtained, and is responsible for reviewing all permits to become familiar with the requirements.

The Contractor and all subcontractors of any tier must obtain a City of Renton Business License (Contractor).

The permits, easements, and right of entry documents that have been acquired are available for inspection and review.

The Contractor shall be required to comply with all conditions of the permits, easements, and rights of entry, at no additional cost to the Contracting Agency. The Contractor is required to indemnify the Contracting Agency from claims on all easements and rights of entry.

All other permits, licenses, etc., shall be the responsibility of the Contractor. The Contractor shall comply with the special provisions and requirements of each.

Permits, permission under franchises, licenses and bonds of a temporary nature necessary for and during the prosecution of the Work, and inspection fees in connection therewith shall be secured and paid for by the Contractor. If the Contracting Agency is required to secure such permits, permission under franchises, licenses and bonds, and pay the fees, the costs incurred by the Contracting Agency thereby shall be charged against the Contractor and deducted from any funds otherwise due the Contractor.

The Contractor is cautioned to review all permits and other Contract Documents and schedule the work activities appropriately to complete the work within the number of days stated in the Contract Document. No additional compensation or extensions to time will be granted to the Contractor due to the time constraints imposed by such documents. The Contractor shall assume all responsibility for meeting all requirements of all permits.

Any fines or penalties incurred by Contracting Agency for not meeting state water quality standards and/or lack of stormwater pollution prevention on this Project shall be deducted from monies otherwise due to Contractor. Any fines assessed directly to Contractor shall be paid directly to the fining authority, at the Contractor's own cost.

1-07.9 Wages

1-07.9(5) Required Documents

Delete the first sentence of the third paragraph, and replace it with the following:

(*****)

The Contractor must submit weekly-certified payrolls for the Contractor and all subcontractors and lower tier subcontractors, regardless of project's funding source.

1-07.11 Requirements for Non-Discrimination

1-07.11(11) City of Renton Affidavit of Compliance

Section 1-07.11(11) is a new section:

(*****)

Each Contractor, Subcontractor, Consultant, and or Supplier shall complete and submit a copy of the "City of Renton Fair Practices Policy Affidavit of Compliance". A copy of this document will be bound in the bid documents.

1-07.12 Federal Agency Inspection

Section 1-07.12 is supplemented with the following:

(*****)

Required Federal Aid Provisions

The Required Contract Provisions Federal Aid Construction Contracts (FHWA 1273) and the amendments thereto supersede any conflicting provisions of the Standard Specifications and are made a part of this contract; provided, however, that if any of the provisions of FHWA 1273, as amended, are less restrictive than Washington State Law, then the Washington State Law shall prevail.

The provisions of FHWA 1273, as amended, included in this contract require that the Contractor insert the FHWA 1273 and amendments thereto in each subcontract, together with the wage rates which are part of the FHWA 1273, as amended. Also, a clause shall be included in each subcontract requiring the subcontractors to insert the FHWA 1273 and amendments thereto in any lower tier subcontracts, together with the wage rates. The Contractor shall also ensure that this Section, REQUIRED FEDERAL AID PROVISIONS, is inserted in each subcontract for subcontractors and lower tier subcontractors. For this purpose, upon request to the Project Engineer, the Contractor will be provided with extra copies of the FHWA 1273, the amendments thereto, the applicable wage rates, and this Special Provision.

1-07.13 Contractor's Responsibility for Work

1-07.13(1) General

Section 1-07.13(1) is supplemented with the following:

(*****)

During unfavorable weather and other conditions, the Contractor shall pursue only such portions of the Work as shall not be damaged thereby.

No portion of the Work whose satisfactory quality or efficiency will be affected by unfavorable conditions shall be constructed while these conditions exist, unless the Contractor shall be able to overcome said unfavorable conditions by special means or precautions acceptable to the Engineer.

1-07.15 Temporary Water Pollution Prevention

Delete this section in its entirety and replace with the following:

(*****)

The Contractor shall perform all Work in strict accordance with all Federal, State, and local laws and regulations governing waters of the State, as well as permits acquired for the project.

The Contractor shall prepare a final Temporary Water Pollution/Erosion Control Plan (TWPECP) and a final SWPPP.

The TWPECP and SWPPP shall be developed in accordance with the erosion control standards contained in the Current City of Renton Surface Water Design Manual. The plan shall include any assumptions, detailed calculations, sketches and sequencing. The plan shall be signed and stamped by a Washington State Professional Engineer. A TESC supervisor shall be designated by the Contractor, whose name and phone number shall be given to the Engineer at the Preconstruction Conference. The TESC supervisor must be CESCL certified in accordance with NPDES permit requirements.

The plan shall be submitted for approval to the City within 10 days of the Notice of Award. The TWPECP shall include the various configurations that may be necessary to adequately control erosion and sediment at the site during the various stages of construction.

Design of dewatering, water control, bypass systems, and temporary erosion and sediment control during construction shall be the responsibility of the Contractor.

At a minimum, the plan shall contain:

1. Manufacturer's data and detailed plans for the erosion control products specified in the plan.
2. Plan for temporary pipe system diversions. This shall include a description of when the piping will be used, pipe material, locations, elevations, plan and profile views, inlet and outlet protection, hydraulic capacity, and details of important design features.
3. Plan for collecting, pumping and pipe surface stormwater runoff, dewatering discharge, and seepage from the source to the Baker Tank or acceptable discharge. The plan shall be shown in phases to coincide with the phases of construction. The plan shall include:
 - a. Layout and details of system.
 - b. Diversion systems manufacturer's data and material submittals.
 - c. Pump and pipe types, sizes, manufacturer's data, and design criteria for pump sizing.

- d. Flow calculations for stormwater, seepage, and dewatering pump discharge. Schedule and sketch of location for dewatering systems. Pumps shall be sized to pump stormwater runoff for the tributary area plus an allowance for groundwater and surface seepage. Each pump area location shall be equipped with two pumps meeting the capacity requirement, in case one is non-operational.
- e. Source of power for pumps, description of schedule and fueling requirements, storage location, and methods.
4. Manufacturer's literature and test results (certificates) on the temporary silt fence, erosion control matting, riprap gradations, and any other necessary erosion control materials.
5. Planned installation and maintenance schedule for temporary erosion and sedimentation control facilities. Indicate locations and outlets of dewatering systems.
6. The boundaries of the clearing limits, sensitive areas and their buffers, and areas of vegetation preservation and tree retention.

The Contractor shall also prepare a final SWPPP. The SWPPP must meet the requirements of the Department of Ecology's NPDES and State Waste Discharge General Permit for Stormwater Discharges Associated with Construction Activity (General Permit). The SWPPP shall include and modify as necessary the Site Preparation and Erosion Control Plan drawings provided as part of the Contract Plans. The Contractor shall prepare, review, and modify the SWPPP as necessary to be consistent with the actual work schedule, sequencing, and construction methods that will be used on the project. The Contractor's SWPPP shall meet the requirements of the general permit.

The Contractor shall:

- Furnish, install, operate, and maintain necessary machinery, appurtenances, and equipment to keep excavations free of water during construction;
- Dewater and dispose of water in a manner that will not cause injury to public and private property, as well as keep sediment-laden water from entering the City surface water system or violate applicable water standards;
- Keep sufficient pumping equipment and machinery on hand at all times for emergencies, including electric power failures;
- Keep experienced personnel available at all times to operate pumping equipment, machinery and appliances;
- Not shut down dewatering systems between shifts, on holidays and weekends, nor during work stoppages without prior authorization by the Engineer;
- Control groundwater to prevent softening of bottoms of excavations, or formation of "quick" conditions or "boils";
- Design and operate dewatering system that will not remove natural soils;
- Keep excavations free of water during excavation, construction of structures, installation of pipelines, placing of structures, backfill, and placing and curing of concrete; and
- Control surface water runoff to prevent entry and collection in excavations.

As construction progresses and unexpected or seasonal conditions dictate, the Contractor shall anticipate that more water pollution/erosion control measures will be necessary. It shall be the obligation and responsibility of the Contractor to revise or supplement the pollution/erosion control measures as may be needed to protect the work, adjacent properties, storm drains, streams, and other water bodies.

At all times, there must be material on the job site to handle any spills caused by the Contractor, such as tack, oils, diesel, etc. Materials would include, but not be limited to, oil absorbent pads and "kitty litter." The Contractor must supply said materials at his expense and, in the event of a spill, be responsible for cleanup and disposal of contaminated materials.

In addition, the SWPPP shall outline the procedures to be used to prevent high pH stormwater or dewatering water from entering surface waters. The plan shall include how the pH of the water will be maintained between pH 6.5 and pH 8.5 prior to being discharged from the project or entering surface waters. Prior to beginning any concrete or grinding work, the Contractor shall submit the plan, for the Engineer's review and approval.

An Ecology template is available to the Contractor for producing the SWPPP, using project- specific information added by the Contractor. The template and instructions are available at: <http://www.ecy.wa.gov/programs/wq/stormwater/construction>.

The Engineer's review and any resulting approval of the Contractor's SWPPP and TESCP will be only regarding conformance with the specification requirement that the Contractor have the plans prepared by a CPESC or professional Civil Engineer who has expertise in the type of facilities and that the SWPPP and TESCP include the items specified for such plans. The Contractor shall be solely responsible for the adequacy of the SWPPP and TESCP and if erosion sediment, and other pollutant control measures in deviation or addition to those described in the SWPPP become necessary to minimize erosion and prevent storm water contamination from sediment and other pollutants, the Contractor shall prepare and submit a revised SWPPP to the Engineer for review as specified for the original plan.

The Contracting Agency will not be liable to the Contractor for failure to accept all or any portion of an originally submitted or revised SWPPP, nor for any delays to the Work due to the Contractor's failure to submit and implement an acceptable SWPPP.

1-07.16 Protection and Restoration of Property

1-07.16(1) Private/Public Property

Section 1-07.16(1) is supplemented with the following:

(*****)

The Contracting Agency will obtain all easements and franchises required for the project. The Contractor shall limit his operation to the areas obtained and shall not trespass on private property.

The Contracting Agency may provide certain lands, as indicated in connection with the Work under the Contract together with the right of access to such lands. The Contractor shall not unreasonably encumber the premises with his equipment or materials.

The Contractor shall provide, with no liability to the Contracting Agency, any additional land and access thereto not shown or described that may be required for temporary construction facilities or storage of materials. He shall construct all access roads, detour roads, or other temporary Work as required by his operations. The Contractor shall confine his equipment, storage of material, and operation of his workers to those areas shown and described and such additional areas as he may provide.

A. General. All construction Work under this contract on easements, right-of-way, over private property or franchise, shall be confined to the limits of such easements, right-of-way or franchise. All Work shall be accomplished so as to cause the least amount of disturbance and a minimum amount of damage. The Contractor shall schedule his Work so that trenches across easements shall not be left open during weekends or holidays and trenches shall not be open for more than 48 hours.

B. Structures. The Contractor shall remove such existing structures as may be necessary for the performance of the Work and, if required, shall rebuild the structures thus removed in as good a condition as found. He shall also repair all existing structures that may be damaged as a result of the Work under this contract.

C. Easements, cultivated areas, and other surface improvements. All cultivated areas, either agricultural or lawns, and other surface improvements which are damaged by actions of the Contractor shall be restored as nearly as possible to their original condition.

Prior to excavation on an easement or private right-of-way, the Contractor shall strip topsoil from the trench or construction area and stockpile it in such a manner that it may be replaced by him, upon completion of construction. Ornamental trees and shrubbery shall be carefully removed with the earth surrounding their roots wrapped in burlap and replanted in their original positions within 48 hours.

All shrubbery or trees destroyed or damaged, shall be replaced by the Contractor with material of equal quality at no additional cost to the Contracting Agency. In the event that it is necessary to trench through any lawn area, the sod shall be carefully cut and rolled and replaced after the trenches have been backfilled. The lawn area shall be cleaned by sweeping or other means, of all earth and debris.

The Contractor shall use rubber wheel equipment similar to the small tractor-type backhoes used by side sewer contractors for all Work, including excavation and backfill, on easements or rights-of-way, which have lawn areas. All fences, markers, mailboxes, or other temporary obstacles shall be removed by the Contractor and immediately replace, after the trench is backfilled, in their original position. The Contractor shall notify the Contracting Agency and Property Owner at least 24 hours in advance of any Work done on easements or rights-of-way.

Damage to existing structures outside of easement areas that may result from dewatering and/or other construction activity under this contract shall be restored to their original condition or better. The original condition shall be established by photographs taken and/or inspection made prior to construction. All such Work shall be done to the satisfaction of the Property Owners and the Contracting Agency at the expense of the Contractor.

D. Streets. The Contractor will assume all responsibility of restoration of the surface of all streets (traveled ways) used by him if damaged.

In the event the Contractor does not have labor or material immediately available to make necessary repairs, the Contractor shall so inform the Contracting Agency. The Contracting Agency will make the necessary repairs and the cost of such repairs shall be paid by the Contractor.

The Contractor is responsible for identifying and documenting any damage that is pre-existing or caused by others. Restoration of excavation in City streets shall be done in accordance with the City of Renton Trench Restoration Requirements, which is available at the Public Works Department Customer Services counter on the 6th floor, Renton City Hall, 1055 South Grady Way or can be found on the City's website at

<https://edocs.rentonwa.gov/Documents/ElectronicFile.aspx?docid=1074326&dbid=0&repo=CityofRenton>.

1-07.17 Utilities and Similar Facilities

Section 1-07.17 is supplemented with the following:

(*****)

Existing utilities indicated in the Plans have been plotted from the best information available to the Engineer. Information and data shown or indicated in the Contract Documents with respect to existing underground utilities or services at or contiguous to the project site are based on information and data furnished to the Contracting Agency and the Engineer by owners of such underground facilities or others, and the Contracting Agency and the Engineer do not assume responsibility for the accuracy or completeness thereof. **It is to be understood that other aboveground or underground facilities not shown in the Plans may be encountered during the course of the Work.**

All utility valves, manholes, vaults, or pull boxes which are buried shall be conspicuously marked in a fashion acceptable to the Contracting Agency and the Engineer by the Contractor to allow their location to be determined by the Engineer or utility personnel under adverse conditions, (inclement weather or darkness).

Where underground main distribution conduits, such as water, gas, sewer, electric power, or telephone, are shown on the Plans, the Contractor, for the purpose of preparing his bid, shall assume that every property parcel will be served by a service connection for each type of utility.

The Contractor shall check with the utility companies concerning any possible conflict prior to commencing excavation in any area. The Contractor shall resolve all crossing and clearance problems with the utility company concerned. No excavation shall begin until all known facilities, in the vicinity of the excavation area, have been located and marked.

In addition to the Contractor having all utilities field marked before starting Work, the Contractor shall have all utilities field marked after they are relocated in conjunction with this project.

Call Before You Dig

The 48-Hour Locators

1-800-424-5555

At least 2 and not more than 10 working days prior to commencing any excavations for utility potholing or for any other purpose under this Contract, the Contractor shall notify the Underground Utilities Location Center by telephone of the planned excavation and progress schedule. The Contractor is also warned that there may be utilities on the project that are not part of the One Call system. They must be contacted directly by the Contractor for locations.

The Contractor shall make arrangements 48 hours in advance with respective utility owners to have a representative present when their utility is exposed or modified, if the utility chooses to do so.

Existing utilities for telephone, power, gas, water, and television cable facilities shall be adjusted or relocated by the appropriate utility company unless otherwise noted in the Plans. These adjustments may be completed before the Contractor begins Work or may be performed in conjunction with the Contract Work. The Contractor shall be entirely responsible for coordination with the utility companies and arranging for the movement or adjustment, either temporary or permanent, of their facilities within the project limits. See also Section 1-05.14 of these Special Provisions.

If or when utility conflicts occur, the Contractor shall continue the construction process on other aspects of the project whenever possible. No additional compensation will be made to the Contractor for reason of delay caused by the actions of any utility company, and the Contractor shall consider such costs to be incidental to the other items of the Contract.

Utility Potholing

Potholing may be included as a bid item for use in determining the location of existing utilities in advance of the Contractor's operations. If potholing is not included as a bid item then it shall be considered incidental to other Work. The Contractor shall submit all potholing requests to the Engineer for approval, at least 2 working days before potholing is scheduled. Additionally, the Contractor shall provide potholing at the Engineer's request.

In no way shall the Work described under Utility Potholing relieve the Contractor of any of the responsibilities described in Section 1-07.17 of the Standard Specifications and Special Provisions, and elsewhere in the Contract Documents.

1-07.17(3) Site Specific Potholing

Section 1-07.17(3) is a new section:

(*****)

Site Specific Potholing is intended to be additional potholing as directed by the Engineer, which is in addition to potholing included as incidental for utility installation. Where underground utilities are found to be in the way of construction, such condition shall not be deemed to be a changed or differing site condition, and if necessary, pipe alignment or grade shall be modified. No payment will be made unless potholing has been performed prior to trench excavation, and witnessed by the Engineer. Different utilities may be found to occupy a common trench. Any two or more utilities separated by 3 feet or less shall constitute one locate. Where multiple utilities exist in close proximity, the Contractor shall be paid for one locate for every 5 feet of exploration trench. The quantity for this item is included to provide a common proposal for bid purposes. The actual quantity used in construction may vary from that amount. The unit price will not be adjusted if the actual quantity used varies by more than 25 percent.

The contractor shall perform this potholing a minimum of five working days prior to crossing to allow for potential revisions. The contractor shall not have cause for claim of down-time or any other additional costs associated with 'waiting' if the owner provides design revisions (related to the information supplied per this section) within three working days after the contractor provides the surveyed elevations.

In no way shall the Work described under Site Specific Potholing relieve the Contractor of any of the responsibilities described in Section 1-07.17 of the Standard Specifications and Special Provisions, and elsewhere in the Contract Documents.

1-07.17(4) Interruption of Services

Section 1-07.17(4) is a new section:

(*****)

Whenever, in the course of the construction operation, it becomes necessary to cause an outage of utilities, it shall be the Contractor's responsibility to notify the affected users and the Engineer not less than 48 hours in advance of such outage. The Contractor shall make reasonable effort to minimize the duration of outages, and shall estimate the length of time service will be interrupted and so notify the users. In the case of any utility outage that has exceeded or will exceed four hours, user contact shall again be made. Temporary service, if needed, will be arranged by the Contractor at no cost to the Contracting Agency.

Overhead lighting outages shall not exceed 24 hours. All cost to the Contractor for providing temporary overhead lighting to meet above requirements shall be incidental to the various unit and Lump sum items of the Contract; no separate payment will be made.

1-07.17(5) Resolution of Utility Conflicts

(*****)

Section 1-07.17(5) is a new section:

In no way shall the work described under Resolution of Utility Conflicts relieve Contractor of any of the responsibilities described in Section 1-07.17 of the Standard Specifications and Special Provisions, and elsewhere in the Contract Documents. If or when utility conflicts occur, Contractor shall continue the construction process on other aspects of the project whenever possible.

If "Resolution of utility conflicts" is included as a bid item in Section 1-09.14, it shall be used to resolve any new identified utility conflicts not otherwise shown on the Contract Drawing or Specifications that are identified during the course of construction.

1-07.18 Public Liability and Property Damage Insurance

Section 1-07.18 Delete this section in its entirety and replace with the following:

(*****)

1-07.18(1) General

The Contractor shall obtain and maintain in full force and effect, from the Contract Execution Date to the Completion Date, public liability and property damage insurance with an insurance company(ies) or through sources approved by the State Insurance Commissioner pursuant to RCW 48.05.

The Contractor shall not begin work under the Contract until the required insurance has been obtained and approved by the Contracting Agency. Insurance shall provide coverage to the Contractor, all subcontractors, Contracting Agency and the Contracting Agency's consultant. The coverage shall protect against claims for bodily injuries, personal injuries, including accidental death, as well as claims for property damages which may arise from any act or omission of the Contractor or the subcontractor, or by anyone directly or indirectly employed by either of them.

If warranted work is required, the Contractor shall provide the City proof that insurance coverage and limits established under the term of the Contract for work are in full force and effect during the period of warranty work.

The Contracting Agency may request a copy of the actual declaration pages(s) for each insurance policy effecting coverage(s) required on the Contract prior to the date work commences.

Failure of the Contractor to fully comply during the term of the Contract with the requirements described herein will be considered a material breach of contract and shall be caused for immediate termination of the Contract at the option of the Contracting Agency.

All costs for insurance shall be incidental to and included in the unit or Lump Sum prices of the contract and no additional payment will be made.

1-07.18(2) Coverages

All coverage provided by the Contractor shall be in a form and underwritten by a company acceptable to the Contracting Agency. The City requires that all insurers:

1. Be licensed to do business within the State of Washington.
2. Coverage to be on an "occurrence" basis (Professional Liability and Pollution coverage are acceptable when written on a claims-made basis). The City may also require proof of professional liability coverage be provided for up to two (2) years after the completion of the project.
3. The City may request a copy of the actual declaration page(s) for each insurance policy affecting coverage(s) required by the Contract prior to the date work commences.
4. Possess a minimum A.M. best rating of AVII (A rating of A XII or better is preferred.). If any insurance carrier possesses a rating of less than AVII, the City may make an exception.

The City reserves the right to approve the security of the insurance coverage provided by the insurance company(ies), terms, conditions, and the Certificate of Insurance.

Failure of the Contractor to fully comply during the term of the Contract with these requirements will be considered a material breach of contract and shall be cause for immediate termination of the contract at the option of the City.

The Contractor shall obtain and maintain the minimum insurance coverage set forth below. By requiring such minimum insurance, the City of Renton shall not be deemed or construed to have assessed the risks that may be applicable to the Contractor. The Contractor shall assess its own risks and if it deems appropriate and/or prudent, maintain higher limits and/or broader coverage.

Coverage shall include:

- A. Commercial General Liability - ISO 1993 Form or equivalent. Coverage will be written on an occurrence basis and include:
 - Premises and Operations (including CG2503; General Aggregate to apply per project, if applicable)
 - Explosion, Collapse, and Underground Hazards.
 - Products/Completed Operations
 - Contractual Liability (including Amendatory Endorsement CG 0043 or equivalent which includes defense coverage assumed under contract)
 - Broad Form Property Damage
 - Independent Contractors

- Personal/Advertising Injury
- Stop Gap Liability
- B. Automobile Liability including all:
 - Owned Vehicles
 - Non-Owned Vehicles
 - Hired Vehicles
- C. Workers' Compensation:
 - Statutory Benefits (Coverage A) - Show Washington Labor & Industries Number
- D. Umbrella Liability (when necessary):
 - Excess of Commercial General Liability and Automobile Liability. Coverage should be as broad as primary.
- E. Professional Liability - (whenever the work under this Contract includes Professional Liability, including Advertising activities) the (CONTRACTOR) shall maintain professional liability covering wrongful acts, errors and/or omissions of the (CONTRACTOR) for damage sustained by reason of or in the course of operations under this Contract.
- F. Pollution Liability - the City may require this coverage whenever work under this Contract involves pollution risk to the environment. This coverage is to include sudden and gradual coverage for third party liability including defense costs and completed operations.

Contractor shall name City of Renton, and its officers, officials, agents, employees and volunteers as Additional Insured (ISO Form CG 2010 or equivalent). The Contractor shall provide City of Renton Certificates of Insurance prior to commencement of work. The City reserves the right to request copies of insurance policies, if at their sole discretion it is deemed appropriate. Further, all policies of insurance described above shall:

- A. Be on a primary basis not contributory with any other insurance coverage and/or self-insurance carried by City of Renton.
- B. Include a Waiver of Subrogation Clause.
- C. Severability of Interest Clause (Cross Liability).
- D. The Contractor shall provide the Contracting Agency and all Additional Insured's with written notice of any policy cancellation, within two business days of their receipt of such notice.
- E. Failure on the part of the Contractor to maintain the insurance as required shall constitute a material breach of contract, upon which the Contracting Agency may, after giving five business days' notice to the Contractor to correct the breach, immediately terminate the contract or, at its discretion, procure or renew such insurance and pay any and all premiums in connection therewith, with any sums so expended to be repaid to the Contracting Agency on demand, or at the sole discretion of the Contracting Agency, offset against funds due the Contractor from the Contracting Agency.

1-07.18(3) Limits

LIMITS REQUIRED

Providing coverage in these stated amounts shall not be construed to relieve the Contractor from liability in excess of such limits. The Contractor shall carry the following limits of liability as required below:

Commercial General Liability

General Aggregate*	\$2,000,000 **
Products/Completed Operations Aggregate	\$2,000,000 **
Each Occurrence Limit	\$1,000,000
Personal/Advertising Injury	\$1,000,000
Fire Damage (Any One Fire)	\$50,000
Medical Payments (Any One Person)	\$5,000
Stop Gap Liability	\$1,000,000
* General Aggregate to apply per project (ISO Form CG2503 or equivalent)	
**Amount may vary based on project risk	
<u>Automobile Liability</u>	
Bodily Injury/Property Damage (Each Accident)	\$1,000,000
<u>Workers' Compensation</u>	
Statutory Benefits - Coverage A (Show Washington Labor and Industries Number)	Variable
<u>Umbrella Liability</u>	
Each Occurrence Limit	\$1,000,000
General Aggregate Limit	\$1,000,000
Products/Completed Operations Aggregate	\$1,000,000
<u>Professional Liability (If required)</u>	
Each Occurrence/ Incident/Claim	\$1,000,000
Aggregate	\$2,000,000
<u>Pollution Liability (If required) to apply on a per project basis</u>	
Per Loss	\$1,000,000
Aggregate	\$1,000,000

The City may require the Contractor to keep professional liability coverage in effect for up to two (2) years after completion of the project.

The Contractor shall promptly advise the CITY OF RENTON in the event any general aggregates are reduced for any reason, and shall reinstate the aggregate at the Contractor's expense to comply with the minimum limits and requirements as stated above and shall furnish to the CITY OF RENTON a new certificate of insurance showing such coverage is in force.

1-07.18(4) Evidence of Insurance:

Within 20 days of award of the Contract, the Contractor shall provide evidence of insurance by submitting to the Contracting Agency the Certificate of Insurance (ACORD Form 25s or equivalent) conforming to items as specified in Sections 1-07.18(1), 1-07.18(2), and 1-07.18(3) as revised above. Other requirements are as follows:

- A. Strike the following or similar wording: "This Certificate is issued as a matter of information only and confers no rights upon the Certificate Holder".

- B. Strike the wording regarding cancellation notification to the City: "Failure to mail such notice shall impose no obligation or liability of any kind upon the company, its agents or representatives".
- C. Amend the cancellation clause to state: "Should any of the above described policies be cancelled before the expiration date thereof, notice will be delivered in accordance with the policy provisions."

For Professional Liability coverage only, instead of the cancellation language specified above, the City will accept a written agreement that the consultant's broker will provide the required notification.

1-07.22 Use of Explosives

Section 1-07.22 is supplemented with the following:

(*****)

Explosives shall not be used without specific authority of the Engineer, and then only under such restrictions as may be required by the proper authorities. Explosives shall be handled and used in strict compliance with WAC 296-52 and such local laws, rules and regulations that may apply. The individual in charge of the blasting shall have a current Washington State Blaster Users License.

The Contractor shall obtain, comply with, and pay for such permits and costs as are necessary in conjunction with blasting operations.

1-07.23 Public Convenience and Safety

1-07.23(1) Construction Under Traffic

Revise the second paragraph to read:

(*****)

To disrupt public traffic as little as possible, the Contractor shall permit traffic to pass through the Work with the least possible inconvenience or delay. The Contractor shall maintain existing roads, streets, sidewalks, driveways, and paths within the project limits, keeping them open, and in good, clean, safe condition at all times. Accessibility to existing or temporary pedestrian push buttons shall not be impaired. Deficiencies caused by the Contractor's operations shall be repaired at the Contractor's expense. Deficiencies not caused by the Contractor's operations shall be repaired by the Contractor when directed by the Engineer, at the Contracting Agency's expense. The Contractor shall also maintain roads, streets, sidewalks, driveways, and paths adjacent to the project limits when affected by the Contractor's operations. Snow and ice control will be performed by the Contracting Agency on all projects. Cleanup of snow and ice control debris will be at the Contracting Agency's expense. The Contractor shall perform the following:

1. Remove or repair any condition resulting from the Work that might impede traffic or create a hazard.
2. Keep existing traffic signal and highway lighting systems in operation as the Work proceeds. (The Contracting Agency will continue the route maintenance on such system.)
3. Maintain the striping on the roadway at the Contracting Agency's expense. The Contractor shall be responsible for scheduling when to renew striping, subject to the approval of the Engineer. When the scope of the project does not require Work on the roadway, the Contracting Agency will be responsible for maintaining the striping.
4. Maintain existing permanent signing. Repair of signs will be at the Contracting Agency's expense, except those damaged due to the Contractor's operations.

5. Keep drainage structures clean to allow for free flow of water. Cleaning of existing drainage structures will be at the Contracting Agency's expense when approved by the Engineer, except when flow is impaired due to the Contractor's operations.
6. At the request of the Contracting Agency, the contractor shall remove steel plates and temporarily backfill and patch utility trenches to allow the Contracting Agency to utilize equipment for snow and ice removal through the project area. This request shall be considered a change of conditions and eligible for reimbursement of costs.

1-07.23(1) is supplemented with the following:

(***)**

The Contractor shall be responsible for controlling dust and mud within the project limits and on any street, which is utilized by his equipment for the duration of the project. The Contractor shall be prepared to use watering trucks, power sweepers, and other pieces of equipment as deemed necessary by the Engineer, to avoid creating a nuisance.

Dust and mud control shall be considered as incidental to the project and no compensation will be made for this section.

Complaints of dust, mud, or unsafe practices and/or property damage to private ownership will be transmitted to the Contractor and prompt action in correcting them will be required by the Contractor.

The Contractor shall maintain the roads during construction in a suitable condition to minimize affects to vehicular and pedestrian traffic. All cost to maintain the roads shall be borne by the Contractor.

At least one-way traffic shall be maintained on all cross-streets within the project limits during working hours. One lane shall be provided in each direction for all streets during non-working hours.

The Contractor shall provide one drivable roadway lane and maintain convenient access for local and commuter traffic to driveways, businesses, and buildings along the line of Work throughout the course of the project. Such access shall be maintained as near as possible to that which existed prior to the commencement of construction. This restriction shall not apply to the paving portion of the construction process.

The Contractor shall notify and coordinate with all property owners and tenants of street closures, or other restrictions which may interfere with their access at least 24 hours in advance for single-family residential property, and at least 48 hours in advance for apartments, offices, and commercial property. The Contractor shall give a copy of all notices to the Engineer.

When the abutting owners' access across the right-of-way line is to be eliminated and replaced under the Contract by other access, the existing access shall not be closed until the replacement access facility is available.

All unattended excavations shall be properly barricaded and covered at all times. The Contractor shall not open any trenches that cannot be completed and refilled that same day. Trenches shall be patched or covered by a temporary steel plate, at the Contractor's expense, except in areas where the roadway remains closed to public traffic. Steel plates must be anchored.

1-07.23(2) Construction and Maintenance of Detours

(*****)

Revise the first paragraph to read:

Unless otherwise approved, the Contractor shall maintain two-way traffic during construction. The Contractor shall build, maintain in a safe condition, keep open to traffic, and remove when no longer needed:

1. Detours and detour bridges that will accommodate traffic diverted from the roadway, bridge, sidewalk, driveway, or path during construction,
2. Detour crossings of intersecting highways, and
3. Temporary approaches.

1-07.24 Rights-of-Way

Delete this section in its entirety, and replace it with the following:

(*****)

Street right-of-way lines, limits of easements, and limits of construction permits are indicated on the Drawings. The Contractor's construction activities shall be confined within these limits unless arrangements for use of private property are made.

Generally, the Contracting Agency will have obtained, prior to bid opening, all rights-of-way and easements, both permanent and temporary, necessary for carrying out the completion of the Work. Exceptions to this are noted in the Contract Documents or brought to the Contractor's attention by a duly issued addendum.

Whenever any of the Work is accomplished on or through property other than public right-of-way, the Contractor shall meet and fulfill all covenants and stipulations of any easement agreement obtained by the Contracting Agency from the owner of the private property. Copies of the easement agreements are included in the Contract Provisions or made available to the Contractor as soon as practical after they have been obtained by the Engineer.

Whenever easements or rights-of-entry have not been acquired prior to advertising, these areas are so noted on the Drawings. The Contractor shall not proceed with any portion of the Work in areas where right-of-way, easements, or rights-of-entry have not been acquired until the Engineer certifies to the Contractor that the right-of-way or easement is available or that the right-of-entry had been received. If the Contractor is delayed due to acts of omission on the part of the Contracting Agency in obtaining easements, rights of entry of right-of-way, the Contractor will be entitled to an extension of time. The Contractor agrees that such delay shall not be a breach of contract.

Each property owner shall be given 48 hours' notice prior to entry by the Contractor. This includes entry onto easements and private property where private improvements must be adjusted.

The Contractor shall be responsible for providing, without expense or liability of the Contracting Agency, any additional land and access thereto that the Contractor may desire for temporary construction facilities, storage of materials, or other Contractor needs. However, before using any private property, whether adjoining the Work or not, the Contractor shall file with the Engineer a written permission of the private property owner, and, upon vacating the premises, a written release from the property owner of each property disturbed or otherwise interfered with by reasons of construction pursued under this Contract. The statement shall be signed by the private property

owner, or proper authority acting for the owner of the private property affected, stating that permission has been granted to use the property and all necessary permits have been obtained or, in the case of a release, that the restoration of the property has been satisfactorily accomplished. The statement shall include the parcel number, address and date of signature. Written releases must be filed with the Engineer before the Completion Date will be established.

1-07.28 Confined Space Entry

Section 1-07.28 is a new section:

The Contractor shall:

1. Review and be familiar with the City's Public Works Confined Space Entry Program.
2. Review documented information about the City confined spaces in which entry is intended as listed and described in the City's Attribute and Map Book. This information includes identified hazards for each permit-required confined space.
3. Each contractor shall have their own confined space entry program. Upon request of the City they will provide a statement confirming they are in compliance with their confined space entry program including requirements for confined space training for employees associated with the project.
4. Be responsible for following all confined space requirements established by the provisions in WAC 296-809 and its chapters.
5. Coordinate entry operations with the City when employees from the contractor will be working in or near City confined spaces.
6. Discuss entry operations with the City, including the program followed during confined space entry.
7. Debrief the City on any hazards confronted or created at the completion of entry operations.
8. Place signs stating, "Danger, Follow Confined Space Entry Procedure before Entering" at each confined space to be entered. Never leave the confined space open and unattended.

The contractor's or consultant's point of contact with the City in regard to confined space entry will be the City's assigned construction inspector.

1-08 PROSECUTION AND PROGRESS

1-08.0 Preliminary Matters

Section 1-08.0 is a new section with subsection:

(*****)

1-08.0(1) Preconstruction Conference

Section 1-08.0(1) is a new subsection:

(*****)

The Engineer will furnish the Contractor with copies of the Contract Documents per Section 1-02.2 "Plans and Specifications". Additional documents may be furnished upon request at the cost of reproduction. Prior to undertaking each part of the Work the Contractor shall carefully study and compare the Contract Documents, and check and verify pertinent figures shown therein and all applicable field measurements. The Contractor shall promptly report in writing to the Engineer any conflict, error or discrepancy, which the Contractor may discover.

After the Contract has been executed, but prior to the Contractor beginning the Work, a preconstruction conference will be held between the Contractor, the Engineer and such other interested parties as may be invited.

The Contractor shall prepare and submit at the preconstruction meeting:

1. Contractor's plan of operation and progress schedule (3+ copies)
2. Approval of qualified subcontractors (bring list of subcontractors if different from list submitted with bid)
3. List of materials fabricated or manufactured off the project
4. Material sources on the project
5. Names of principal suppliers
6. Detailed equipment list, including "Rental Rate Blue Book" hourly costs (both working and standby rates)
7. Weighted wage rates for all employee classifications anticipated to be used on Project
8. Cost percentage breakdown for lump sum bid item(s)
9. Shop Drawings (bring preliminary list)
10. Traffic Control Plans (3+ copies)
11. Temporary Water Pollution/Erosion Control Plan
12. Shoring Plans (per section 1-09.14(2)B), if applicable

In addition, the Contractor shall be prepared to address:

- Bonds and insurance
- Project meetings – schedule and responsibilities
- Provision for inspection for materials from outside sources
- Responsibility for locating utilities
- Responsibility for damage
- Time schedule for relocations, if by other than the Contractor
- Compliance with Contract Documents
- Acceptance and approval of Work
- Labor compliance, payrolls, and certifications
- Safety regulations for the Contractors' and the Contracting Agency's employees and representatives
- Suspension of Work, time extensions
- Change order procedures
- Progress estimates, procedures for payment
- Special requirements of funding agencies
- Construction engineering, advance notice of special Work
- Any interpretation of the Contract Documents requested by the Contractor
- Any conflicts or omissions in Contract Documents
- Any other problems or questions concerning the Work
- Processing and administration of public complaints
- Easements and rights-of-entry
- Other contracts

The franchise utilities may be present at the preconstruction conference, and the Contractor should be prepared for their review and discussion of progress schedule and coordination.

1-08.0(2) Hours of Work

Section 1-08.0(2) is a new subsection:

(*****)

Except in the case of emergency or unless otherwise approved by the Contracting Agency, the normal straight time working hours for the Contract shall be any consecutive 8-hour period between 7:00 a.m. and 5:00 p.m. of a working day with a maximum 1-hour lunch break and a 5-day Work week. The normal straight time 8-hour working period for the Contract shall be established at the preconstruction conference or prior to the Contractor commencing the Work.

If a Contractor desires to perform Work before 7:00 a.m. or after 5:00 p.m. on any day, the Contractor shall apply in writing to the Engineer for permission to Work such times. Permission to Work longer than an 8-hour period between 7:00 a.m. and 5:00 p.m. is required. Such requests shall be submitted to the Engineer no later than noon on the working day prior to the day for which the Contractor is requesting permission to Work.

Permission to Work between the hours of 10:00 p.m. and 7:00 a.m. during weekdays and between the hours of 10:00 p.m. and 7:00 a.m. on weekends or holidays may also be subject to noise control requirements. Approval to continue Work during these hours may be revoked at any time the Contractor exceeds the Contracting Agency's noise control regulations or complaints are received from the public or adjoining property owners regarding the noise from the Contractor's operations. The Contractor shall have no claim for damages or delays should such permission be revoked for these reasons.

Permission to Work Saturdays, Sundays, holidays or other than the agreed upon normal straight time working hours Monday through Friday may be given subject to certain other conditions set forth by the Contracting Agency or the Engineer. These conditions may include but are not limited to: requiring the Engineer or such assistants as the Engineer may deem necessary to be present during the Work; requiring the Contractor to reimburse the Contracting Agency for the cost of engineering salaries paid Contracting Agency employees who worked during such times; considering the Work performed on Saturdays, Sundays, and holidays as working days with regards to the Contract Time; and considering multiple Work shifts as multiple working days with respect to Contract Time even though the multiple shifts occur in a single 24-hour period. Assistants may include, but are not limited to, survey crews; personnel from the material testing labs; inspectors; and other Contracting Agency employees when in the opinion of the Engineer such Work necessitates their presence.

1-08.0(3) Reimbursement for Overtime Work of Contracting Agency Employees

Section 1-08.0(3) is a new subsection:

(*****)

Where the Contractor elects to Work on a Saturday, Sunday, holiday, or longer than an 8-hour Work shift on a regular working day, as defined in the Standard Specifications, such Work shall be considered as overtime Work. On all such overtime Work an inspector will be present, and a survey crew may be required at the discretion of the Engineer. The Contractor shall reimburse the Contracting Agency for the full amount of the straight time plus overtime costs for employees and representative(s) of the Contracting Agency required to work overtime hours.

The Contractor, by these Specifications, does hereby authorize the Engineer to deduct such costs from the amount due or to become due the Contractor.

1-08.1 Subcontracting

(*****)

Revise the second paragraph to read:

The Contractor shall not subcontract Work unless the Engineer approves in writing. Each request to subcontract shall be on the form the Engineer provides. If the Engineer requests, the Contractor shall provide proof that subcontractor has the experience, ability, and equipment the Work requires. The Contractor shall require each subcontractor to comply with Section 1-07.9 and to furnish all certificates and statements required by the Contract. The Contractor shall require each subcontractor of every tier to meet the responsibility criteria stated in RCW 39.06, and shall include these requirements in every subcontract of every tier.

Section 1-08.1 is supplemented with the following:

(*****)

Written requests for change in subcontractors shall be submitted by the Contractor to the Engineer at least 7 calendar days prior to start of a subcontractor's Work.

The Contractor agrees that he/she is fully responsible to the Contracting Agency for the acts and omissions of all subcontractors and lower-tier subcontractors, and persons either directly or indirectly employed by the subcontractors, as well as for the acts and omissions of persons directly employed by the Contractor. The Contractor shall be required to give personal attention to the Work that is sublet. Nothing contained in the Contract Documents shall create any contractual relation between any subcontractor and the Contracting Agency.

The Contractor shall be responsible for making sure all subcontractors submit all required documentation, forms, etc.

1-08.2 Assignment

The second paragraph of Section 1-08.2 is deleted and replaced with the following:

(*****)

The Contractor shall not assign any moneys due or to become due to the Contractor hereunder without the prior written consent of the Contracting Agency. The assignment, if approved, shall be subject to all setoffs, withholdings, and deductions required by law and the Contract.

1-08.3 Progress Schedule

Delete this section in its entirety and replace with the following:

(*****)

The progress schedule for the entire project shall be submitted **7 calendar days prior to the Preconstruction Conference**. The schedule shall be prepared using the critical path method (CPM), preferably using Microsoft Project or equivalent software. The schedule shall contain the following information, at a minimum:

1. Construction activities, in sufficient detail that all activities necessary to construct a complete and functional project are considered. Any activity that has a scheduled duration exceeding 30 calendar days shall be subdivided until no sub-element has a duration exceeding 30 calendar days.
2. The schedule shall clearly indicate the activities that comprise the critical path. For each activity not on the critical path, the schedule shall show the float, or slack, time.

3. Procurement of material and equipment.
4. Submittals requiring review by the Engineer. Submittal by the Contractor and review by the Engineer shall be shown as separate activities.
5. Work to be performed by a subcontractor, agent, or any third party.
6. Allowances for delays that could result from normal inclement weather (time extensions due to inclement weather will not be allowed).
7. Allowances for the time required by utilities (Contracting Agency's and others) to locate, monitor, and adjust their facilities as required.

The Engineer may request the Contractor to alter the progress schedule when deemed necessary in the opinion of the Engineer, in the interest of public safety and welfare of the Contracting Agency, or for coordination with any other activity of other contractors, the availability of all or portions of the job site, or special provisions of this Contract, or to reasonably meet the completion date of the project. The Contractor shall provide such revised schedule within 10 days of request.

If, at any time, in the opinion of the Engineer, the progress of construction falls significantly behind schedule, the Contractor may be required to submit a plan for regaining progress and a revised schedule indicating how the remaining Work items will be completed within the authorized contract time.

The Contractor shall promptly report to the Engineer any conditions that the Contractor feels will require revision of the schedule and shall promptly submit proposed revisions in the progress schedule for acceptance by the Engineer. When such changes are accepted by the Engineer, the revised schedule shall be followed by the Contractor.

Weekly Schedule. The Contractor shall submit a weekly progress schedule to the Engineer which sets forth specific Work to be performed the following week, and a tentative schedule for the second week.

Failure to Maintain Progress Schedule. The Engineer will check actual progress of the Work against the progress schedule a minimum of two times per month. Failure, without just cause, to maintain progress in accordance with the approved schedule shall constitute a breach of Contract. If, through no fault of the Contractor, the proposed construction schedule cannot be met, the Engineer will require the Contractor to submit a revised schedule to the Engineer for acceptance. The approved revisions will thereafter, in all respects, apply in lieu of the original schedule.

Failure of the Contractor to follow the progress schedule submitted and accepted, including revisions thereof, shall relieve the Contracting Agency of any and all responsibility for furnishing and making available all or any portion of the job site, and will relieve the Contracting Agency of any responsibility for delays to the Contractor in the performance of the Work.

The cost of preparing the progress schedule, any supplementary progress schedules, and weekly schedules shall be considered incidental to the Contract and no other compensation shall be made.

1-08.4 Prosecution of the Work

Section 1-08.4 Delete this section in its entirety and replace with the following:

(*****)

Notice to Proceed will be given after the Contract has been executed and the Contract bond and evidence of insurances have been approved and filed by the Contracting Agency. The Contractor shall not commence the Work until the Notice to Proceed has been given by the Engineer. The Contractor shall commence construction activities on the project site within ten days of the Notice to Proceed date. The Work thereafter shall be prosecuted diligently, vigorously, and without unauthorized interruption until physical completion of the Work. There shall be no voluntary shutdowns or slowing of operations by the Contractor without prior approval of the Engineer. Such approval shall not relieve the Contractor from the contractual obligation to complete the Work within the prescribed Contract Time.

1-08.5 Time For Completion

Delete this section in its entirety and replace with the following:

(*****)

The Work shall be physically completed in its entirety within the time specified in the Contract Documents or as extended by the Engineer. The Contract Time will be stated in “working days”, shall begin on the Notice To Proceed date, or the date identified in the Notice to Proceed as “the first working day”, and shall end on the Contract Completion date.

A non-working day is defined as a Saturday, a Sunday, a day on which the Contract specifically suspends Work, or one of these holidays:

- New Year’s Day
- Martin Luther King Day
- Memorial Day
- Independence Day
- Labor Day
- Veteran’s Day
- Thanksgiving Day
- the day after Thanksgiving
- Christmas Day.

Note for holidays that land on a Saturday or Sunday: The day before Christmas shall be a holiday when Christmas Day occurs on a Tuesday, Wednesday, or Friday. The day after Christmas shall be a holiday when Christmas Day occurs on a Monday or Thursday. When Christmas Day occurs on a Saturday, the two preceding working days shall be observed as holidays. When Christmas day occurs on a Sunday, the two working days following shall be observed as holidays. When holidays other than Christmas fall on a Saturday, the preceding Friday will be counted as a non-working day and when they fall on a Sunday the following Monday will be counted as a non-working day.

The Contract Time has been established to allow for periods of normal inclement weather that, from historical records, is to be expected during the Contract Time, and during which periods, Work is anticipated to be performed. Each successive working day, beginning with the Notice to Proceed date and ending with the Physical Completion date, shall be charged to the Contract Time as it occurs except a day, or part of a day, which is designated a non-working day or an Engineer determined unworkable day.

The Engineer will furnish the Contractor a weekly report showing (1) the number of working days charged against the Contract Time for the preceding week; (2) the Contract Time in working days; (3) the number of working days remaining in the Contract Time; (4) the number of non-working days; and (5) any partial or whole days the Engineer declared unworkable the previous week. This weekly report will be correlated with the Contractor's current approved progress schedule. If the Contractor elects to work 10 hours a day and 4 days a week (a 4-10 schedule), and the fifth day of the week in which a 4-10 shift is worked would ordinarily be charged as a working day, then the fifth day of that week will be charged as a working day whether or not the Contractor works on that day.

The Contractor will be allowed 10 calendar days from the date of each report in which to file a written protest of an alleged discrepancy in the Contract Time as reported. Otherwise, the report will be deemed to have been accepted by the Contractor as correct.

The requirements for scheduling the Final Inspection and establishing the Substantial Completion, Physical Completion, and Completion Dates are specified in Sections 1-05.11 and 1-05.12.

The Engineer will give the Contractor written notice of the completion date of the Contract after all the Contractor's obligations under the Contract have been performed by the Contractor. The following events must occur before the Completion Date can be established:

1. The physical Work on the project must be complete; and
2. The Contractor must furnish all documentation required by the Contract and required by law, to allow the Contracting Agency to process final acceptance of the Contract. The following documents must be received by the Engineer prior to establishing a completion date:
 - a. Certified Payrolls per Section 1-07.9(5)
 - b. Material Acceptance Certification Documents
 - c. Annual Report of Amounts Paid as MBE/WBE Participants or Quarterly Report of Amounts Credited as DBE Participation, as required by the Contract Provisions.
 - d. FHWA 47 (Federal-aid Projects)
 - e. Final Contract Voucher Certification
 - f. Property owner releases per Section 1-07.24
 - g. A copy of the Notice of Termination sent to the Washington State Department of Ecology (Ecology); the elapse of 30 calendar days from the date of receipt of the Notice of Termination by Ecology; and no rejection of the Notice of Termination by Ecology. This requirement will not apply if the Construction Stormwater General Permit is transferred back to the Contracting Agency in accordance with Section 8-01.3(16), as required by the Contract Provisions.

Within 10 calendar days after execution of the Contract by the Contracting Agency, the Contractor shall provide the Contracting Agency with copies of purchase orders for all equipment items deemed critical by the Contracting Agency, including but not limited to signal controller materials, lighting standards, and signal standards required for the physical completion of the Contract. Such purchase orders shall disclose the estimated delivery dates for the equipment.

All items of Work that can be performed without delivery of the critical items shall start and be completed as soon as possible. At that time, the Engineer may suspend the Work upon request of the Contractor until the critical items are delivered to the Contractor, if the Contracting Agency

received a purchase order within 10 calendar days after execution of the Contract by the Contracting Agency.

The Contractor will be entitled to only one such suspension of time during the performance of the Work and during such suspension shall not perform any additional Work on the project. Upon delivery of the critical items, contract time will resume and continue to be charged in accordance with Section 1-08.

1-08.6 Suspension of Work

Section 1-08.6 is supplemented with the following:

(*****)

Contracting Agency may at any time suspend the Work, or any part thereof, by giving notice to the Contractor in writing. The Work shall be resumed by the Contractor within 14 calendar days after the date fixed in the written notice from the Contracting Agency to the Contractor to do so.

The Contractor shall not suspend Work under the Contract without the written order of the Contracting Agency.

If it has been determined that the Contractor is entitled to an extension of time, the amount of such extension shall be only to compensate for direct delays, and shall be based upon the Contractor's diligently pursuing the Work at a rate not less than that which would have been necessary to complete the original Contract Work on time.

1-08.7 Maintenance During Suspension

Revise the second paragraph to read:

(*****)

At no expense to the Contracting Agency, the Contractor shall provide through the construction area a safe, smooth, and unobstructed roadway, sidewalk, driveway, and path for public use during suspension (as required in Section 1-07.23 or the Special Provisions). This may include a temporary road or detour.

1-08.9 Liquidated Damages

Section 1-08.9 is supplemented with the following:

(*****)

In addition, the Contractor shall compensate the Contracting Agency for actual engineering inspection and supervision costs and any other expenses and legal fees incurred by the Contracting Agency as a result of such delay. Such labor costs will be billed to the Contractor at actual costs, including administrative overhead costs.

In the event that the Contracting Agency is required to commence any lawsuit in order to enforce any provision of this Contract or to seek redress for any breach thereof, the Contracting Agency shall be entitled to recover its costs, including reasonable attorney's fees, from the Contractor.

1-08.11 Contractor's Plant and Equipment

Section 1-08.11 is a new Section:

(*****)

The Contractor alone shall at all times be responsible for the adequacy, efficiency, and sufficiency of his and his subcontractor's plant and equipment. The Contracting Agency shall have the right to make use of the Contractor's plant and equipment in the performance of any Work on the site of the Work.

The use by the Contracting Agency of such plant and equipment shall be considered as extra Work and paid for accordingly.

Neither the Contracting Agency nor the Engineer assumes any responsibility, at any time, for the security of the site from the time the Contractor's operations have commenced until final acceptance of the Work by the Engineer and the Contracting Agency. The Contractor shall employ such measures as additional fencing, barricades, and watchmen service, as he deems necessary for the public safety and for the protection of the site and his plant and equipment. The Contracting Agency will be provided keys for all fenced, secured areas.

1-08.12 Attention to Work

Section 1-08.12 is a new section:

(*****)

The Contractor shall give his personal attention to and shall supervise the Work to the end that it shall be prosecuted faithfully, and when he is not personally present on the Work site, he shall at all times be represented by a competent superintendent who shall have full authority to execute the same, and to supply materials, tools, and labor without delay, and who shall be the legal representative of the Contractor. The Contractor shall be liable for the faithful observance of any instructions delivered to him or to his authorized representative.

1-09 MEASUREMENT AND PAYMENT

1-09.1 Measurement of Quantities

Section 1-09.1 is supplemented with the following:

(*****)

Lump Sum. The percentage of lump sum Work completed, and payment will be based on the cost percentage breakdown of the lump sum bid price(s) submitted at the preconstruction conference.

The Contractor shall submit a breakdown of costs for each lump sum bid item. The breakdown shall list the items included in the lump sum together with a unit price of labor, materials, and equipment for each item. The summation of the detailed unit prices for each item shall add up to the lump sum bid. The unit price values may be used as a guideline for determining progress payments or deductions or additions in payment for ordered Work changes.

Cubic Yard Quantities. The Contractor shall provide truck trip tickets for progress payments only in the following manner. Where items are specified to be paid by the cubic yard, the following tally system shall be used.

All trucks to be employed on this Work will be measured to determine the volume of each truck. Each truck shall be clearly numbered, to the satisfaction of the Engineer, and there shall be no duplication of numbers.

Duplicate tally tickets shall be prepared to accompany each truckload of material delivered on the project. All tickets received that do not contain the following information will not be processed for payment:

1. Truck number
2. Quantity and type of material delivered in cubic yards
3. Driver's name, date and time of delivery
4. Location of delivery, by street and stationing on each street
5. Place for the Engineer to acknowledge receipt
6. Pay item number
7. Contract number and/or name

It will be the Contractor's responsibility to see that a ticket is given to the Engineer on the project for each truckload of material delivered. Pay quantities will be prepared on the basis of said tally tickets.

Loads will be checked by the Engineer to verify quantity shown on ticket.

Quantities by Ton. It will be the Contractor's responsibility to see that a certified weight ticket is given to the Inspector on the project at the time of delivery of materials for each truckload delivered. Pay quantities will be prepared on the basis of said tally tickets, delivered to the Inspector at time of delivery of materials. Tickets not receipted by Inspector will not be honored for payment.

Each truck shall be clearly numbered to the satisfaction of the Engineer and there shall be no duplication of numbers.

Duplicate tickets shall be prepared to accompany each truckload of material delivered to the project. All tickets received that do not contain the following information will not be processed for payment:

1. Truck number
2. Truck tare weight (stamped at source)
3. Gross truckload weight in tons (stamped at source)
4. Net load weight (stamped at source)
5. Driver's name, date, and time of delivery
6. Location for delivery by street and stationing on each street
7. Place for the Engineer to acknowledge receipt
8. Pay item number
9. Contract number and/or name

1-09.3 Scope of Payment

Section 1-09.3 is supplemented with the following:

(*****)

The bid items listed in Section 1-09.14 will be the only items for which compensation will be made for the Work described in each section of the Standard Specifications when the Contractor performs the specified Work. Should a bid item be listed in a "Payment" clause but not in the Proposal Form, and Work for that item is performed by the Contractor and the Work is not stated as included in or incidental to a pay item in the Contract and is not Work that would be required to complete the intent

of the Contract per Section 1-04.1, then payment for that Work will be made as for Extra Work pursuant to a Change Order.

The words "Bid Item," "Contract Item," and "Pay Item," and similar terms used throughout the Contract Documents are synonymous.

If the "payment" clause in the Specifications relating to any unit bid item price in the Proposal Form requires that said unit bid item price cover and be considered compensation for certain Work or material essential to the item, then the Work or material will not be measured or paid for under any other unit bid item which may appear elsewhere in the Proposal Form or Specifications.

Pluralized unit bid items appearing in these Specifications are changed to singular form.

Payment for bid items listed or referenced in the "Payment" clause of any particular section of the Specifications shall be considered as including all of the Work required, specified, or described in that particular section. Payment items will generally be listed generically in the Specifications, and specifically in the bid form. When items are to be "furnished" under one payment item and "installed" under another payment item, such items shall be furnished FOB project site, or, if specified in the Special Provisions, delivered to a designated site. Materials to be "furnished," or "furnished and installed" under these conditions, shall be the responsibility of the Contractor with regard to storage until such items are incorporated into the Work or, if such items are not to be incorporated into the Work, delivered to the applicable Contracting Agency storage site when provided for in the Specifications. Payment for material "furnished," but not yet incorporated into the Work, may be made on monthly estimates to the extent allowed.

1-09.6 Force Account

Section 1-09.6 is supplemented with the following:

(*****)

Contracting Agency has estimated and included in the proposal, dollar amounts for all items to be paid per force account, only to provide a common proposal for Bidders. All such dollar amounts are to become a part of the Contractor's total bid. However, the Contracting Agency does not warrant expressly or by implication that the actual amount of Work will correspond with those estimates. Payment will be made on the basis of the amount of Work actually authorized by the Engineer.

1-09.7 Mobilization

Section 1-09.7 is supplemented with the following:

(*****)

Mobilization shall also include, but not be limited to, the following items: the movement of Contractor's personnel, equipment, supplies, and incidentals to the project site; the establishment of an office, buildings, and other facilities necessary for Work on the project; providing sanitary facilities for the Contractor's personnel; and obtaining permits or licenses required to complete the project not furnished by the Contracting Agency.

This item shall also include providing the Engineer and the Inspectors with access to telephone, facsimile machine, and copy machine during all hours the Contractor is working on the jobsite; and a table and chair for their use when needed.

Payment will be made for the following bid item(s):
"Mobilization & Demobilization," Lump Sum.

1-09.9 Payments

Delete the fourth paragraph and replace it with the following:

(*****)

Progress payments for completed Work and material on hand will be based upon progress estimates prepared by the Engineer. A progress estimate cutoff date will be established at the preconstruction meeting.

The initial progress estimate will be made not later than 30 days after the Contractor commences the Work, and successive progress estimates will be made every month thereafter until the Completion Date. Progress estimates made during progress of the Work are tentative, and made only for the purpose of determining progress payment. The progress estimates are subject to change at any time prior to the calculation of the final payment.

The value of the progress estimate will be the sum of the following:

1. Unit Price Items in the Bid Form – the approximate quantity of acceptable units of Work completed multiplied by the unit price.
2. Lump Sum Items in the Bid Form – the estimated percentage complete multiplied by the Bid Forms amount for each lump sum item, or per the schedule of values for that item.
3. Materials on Hand – 100 percent of invoiced cost of material delivered to job site or other storage area approved by the Engineer.
4. Change Orders – entitlement for approved extra cost or completed extra Work as determined by the Engineer.

Progress payments will be made in accordance with the progress estimate less:

1. Retainage per Section 1-09.9(1);
2. The amount of Progress Payments previously made; and
3. Funds withheld by the Contracting Agency for disbursement in accordance with the Contract Documents.

Progress payments for Work performed shall not be evidence of acceptable performance or an admission by the Contracting Agency that any Work has been satisfactorily completed.

Payments will be made by check or electronic transfer, issued by the Contracting Agency's fiscal officer, against the appropriate fund source for the project. Payments received on account of Work performed by a subcontractor are subject to the provisions of RCW 39.04.250.

Section 1-09.9 is supplemented with the following:

(*****)

Applications for payment shall be itemized and supported to the extent required by the Engineer by receipts or other vouchers showing payment for materials and labor, payments to subcontractors, and other such evidence of the Contractor's right to payment as the Engineer may direct, including "red line" as-built drawings showing work installed by the contractor during the progress payment period.

The Contractor shall submit a progress report with each monthly request for a progress payment. The progress report shall indicate the estimated percent complete for each activity listed on the progress schedule (see Section 1-08.3) and a revised and updated schedule to reflect the most current project completion date.

1-09.9(1) Retainage

Section 1-09.9(1) is supplemented with the following:

(*****)

The retained amount shall be released as stated in the Standard Specifications if no claims have been filed against such funds as provided by law, and if the Contracting Agency has no unsatisfied claims against the Contractor. In the event claims are filed, the Contracting Agency shall withhold, until such claims are satisfied, a sum sufficient to satisfy all claims and to pay attorney's fees. In addition, the Contracting Agency shall withhold such amount as is required to satisfy any claims by the Contracting Agency against the Contractor, until such claims have been finally settled.

Neither the final payment nor any part of the retained percentage shall become due until the Contractor, if requested, delivers to the Contracting Agency a complete release of all liens arising out of this Contract, or receipts in full in lieu thereof, and, if required in either case, an affidavit that so far as the Contractor has knowledge or information, the release and receipts include all labor and materials for which a lien could be filed: but the Contractor may, if any subcontractor refuses to furnish a release or receipt in full, furnish a bond satisfactorily to the Engineer to indemnify the Contracting Agency against the lien. If any lien remains unsatisfied after all payments are made, the Contractor shall reimburse to the Contracting Agency all monies that the latter may be compelled to pay in discharging such lien, including all costs and reasonable engineer's and attorney's fees.

1-09.9(2) Contracting Agency's Right to Withhold and Disburse Certain Amounts

Section 1-09.9(2) is a new section:

(*****)

In addition to monies retained pursuant to RCW 60.28 and subject to RCW 39.04.250, RCW 39.12 and RCW 39.76, the Contractor authorizes the Engineer to withhold progress payments due or deduct an amount from any payment or payments due the Contractor which, in the Engineer's opinion, may be necessary to cover the Contracting Agency's costs for or to remedy the following situations:

1. Damage to another contractor when there is evidence thereof and a claim has been filed.
2. Where the Contractor has not paid fees or charges to public authorities of municipalities, which the Contractor is obligated to pay.
3. Utilizing material tested and inspected by the Engineer, for purposes not connected with the Work (Section 1-05.6).
4. Landscape damage assessments per Section 1-07.16.
5. For overtime Work performed by City personnel per Section 1-08.0(3).
6. Anticipated or actual failure of the Contractor to complete the Work on time:
 - a. Per Section 1-08.9 Liquidated Damages; or
 - b. Lack of construction progress based upon the Engineer's review of the Contractor's approved progress schedule, which indicates the Work will not be complete within the contract time. When calculating an anticipated time overrun, the Engineer will make allowances for weather delays, approved unavoidable delays, and suspensions of the Work. The amount withheld under this subparagraph will be based upon the liquidated damages amount per day set forth in Contract Documents multiplied by

the number of days the Contractor's approved progress schedule, in the opinion of the Engineer, indicates the Contract may exceed the Contract Time.

7. Failure of the Contractor to perform any of the Contractor's other obligations under the Contract, including but not limited to:
 - a. Failure of the Contractor to provide the Engineer with a field office when required by the Contract Provisions.
 - b. Failure of the Contractor to protect survey stakes, markers, etc., or to provide adequate survey Work as required by Section 1-05.4.
 - c. Failure of the Contractor to correct defective or unauthorized Work (Section 1-05.7).
 - d. Failure of the Contractor to furnish a Manufacturer's Certificate of Compliance in lieu of material testing and inspection as required by Section 1-06.3.
 - e. Failure to submit weekly payrolls, Intent to Pay Prevailing Wage forms, or correct underpayment to employees of the Contractor or subcontractor of any tier as required by Section 1-07.9.
 - f. Failure of the Contractor to pay worker's benefits (Title 50 and Title 51 RCW) as required by Section 1-07.10.
 - g. Failure of the Contractor to submit and obtain approval of a progress schedule per Section 1-08.3.

The Contractor authorizes the Engineer to act as agent for the Contractor disbursing such funds as have been withheld pursuant to this Section to a party or parties who are entitled to payment. Disbursement of such funds, if the Engineer elects to do so will be made only after giving the Contractor 15 calendar days prior written notice of the Contracting Agency's intent to do so, and if prior to the expiration of the 15-calendar day period,

1. No legal action has commenced to resolve the validity of the claims, and
2. The Contractor has not protested such disbursement.

A proper accounting of all funds disbursed on behalf of the Contractor in accordance with this Section will be made. A payment made pursuant to this section shall be considered as payment made under the terms and conditions of the Contract. The Contracting Agency shall not be liable to the Contractor for such payment made in good faith.

1-09.9(3) Final Payment

Section 1-09.9(3) is a new section:

(*****)

Upon Acceptance of the Work by the Contracting Agency, the final amount to be paid the Contractor will be calculated based upon a Final Progress Estimate made by the Engineer. Acceptance by the Contractor of the final payment shall be and shall operate as a release:

1. To the Contracting Agency of all claims and all liabilities of the Contractor, other than claims in stated amounts as may be specifically excepted in writing by the Contractor;
2. For all things done or furnished in connection with the Work;
3. For every act and neglect by the Contracting Agency; and
4. For all other claims and liability relating to or arising out of the Work.

A payment (monthly, final, retainage, or otherwise) shall not release the Contractor or the Contractor's Surety from any obligation required under the terms of the Contract Documents or the Contract Bond; nor shall such payment constitute a waiver of the Contracting Agency's ability to investigate and act upon findings of non-compliance with the WMBE requirements of the Contract;

nor shall such payment preclude the Contracting Agency from recovering damages, setting penalties, or obtaining such other remedies as may be permitted by law.

Before the Work will be accepted by the Contracting Agency, the Contractor shall submit an affidavit, on the form provided by the Engineer, of amounts paid to certified disadvantaged (DB), minority (MBE) or women business enterprises (WBE) participating in the Work. Such affidavit shall certify the amounts paid to the DB, MBE or WBE subcontractors regardless of tier.

On federally funded projects the Contractor may also be required to execute and furnish the Contracting Agency an affidavit certifying that the Contractor has not extended any loans, gratuity or gift and money pursuant to Section 1-07.19 of these Specifications.

If the Contractor fails, refuses, or is unable to sign and return the Final Progress Estimate or any other documents required for the final acceptance of the Contract, the Contracting Agency reserves the right to establish a completion date and unilaterally accept the Contract. Unilateral acceptance will occur only after the Contractor has been provided the opportunity, by written request from the Engineer, to voluntarily submit such documents. If voluntary compliance is not achieved, formal notification of the impending unilateral acceptance will be provided by certified letter from the Engineer to the Contractor that will provide 30 calendar days for the Contractor to submit the necessary documents. **The 30-calendar day deadline shall begin on the date of the postmark of the certified letter from the Engineer requesting the necessary documents.** This reservation by the Contracting Agency to unilaterally accept the Contract will apply to contracts that are completed in accordance with Section 1-08.5 and for contracts that are terminated in accordance with Section 1-08.10. Unilateral acceptance of the Contract by the Contracting Agency does not relieve the Contractor of the provisions under contract or of the responsibility to comply with all laws, ordinances, and federal, state, and local regulations that affect the Contract. The date the Contracting Agency unilaterally signs the Final Progress Estimate constitutes the final acceptance date (Section 1-05.12).

1-09.11 Disputes and Claims

1-09.11(2) Claims

Paragraph 5 is revised with the following:

(*****)

Failure to submit with the Final Application for Payment such information and details as described in this section for any claim shall operate as a waiver of the claims by the Contractor as provided in Section 1-09.9.

1-09.11(3) Time Limitations and Jurisdiction

Paragraph 1, Sentence 1 is revised with the following:

(*****)

...such claims or causes of action shall be brought in the Superior Court of the county where the Work is performed.

1-09.13 Claims and Resolutions

1-09.13(3) Claims \$250,000 or Less

Delete this Section and replace it with the following:

(*****)

The Contractor and the Contracting Agency mutually agree that those claims that total \$250,000 or less, submitted in accordance with Section 1-09.11 and not resolved by nonbonding ADR processes, shall be resolved through litigation, unless the parties mutually agree in writing to resolve the claim through binding arbitration.

1-09.13(3)A Administration of Arbitration

Revise the third paragraph to read:

(*****)

The Contracting Agency and the Contractor mutually agree to be bound by the decision of the arbitrator, and judgment upon the award rendered by the arbitrator may be entered in the Superior Court of the county in which the Contracting Agency's headquarters are located. The decision of the arbitrator and the specific basis for the decision shall be in writing. The arbitrator shall use the Contract as a basis for decisions.

1-09.13(3)B Procedures to Pursue Arbitration

Section 1-09.13(3)B is supplemented with the following:

(*****)

The findings and decision of the board of arbitrators shall be final and binding on the parties, unless the aggrieved party, within 10 days, challenges the findings and decision by serving and filing a petition for review by the superior court of King County, Washington. The grounds for the petition for review are limited to showing that the findings and decision:

1. Are not responsive to the questions submitted;
2. Is contrary to the terms of the contract or any component thereof;
3. Is arbitrary and/or is not based upon the applicable facts and the law controlling the issues submitted to arbitration. The board of arbitrators shall support its decision by setting forth in writing their findings and conclusions based on the evidence adduced at any such hearing.

The arbitration shall be conducted in accordance with the statutes of the State of Washington and court decisions governing such procedure.

The costs of such arbitration shall be borne equally by the Contracting Agency and the Contractor unless it is the board's majority opinion that the Contractor's filing of the protest or action is capricious or without reasonable foundation. In the latter case, all costs shall be borne by the Contractor.

1-09.14 Payment Schedule

Measurement and Payment Schedule for Bid Items in This Project Proposal

Section 1-09.14 is a new section:

(*****)

GENERAL

1-09.14(1) Scope

Section 1-09.14(1) is a new section:

(*****)

- A. Payment for the various items of the bid sheets, as further specified herein, shall include all compensation to be received by the Contractor for furnishing all tools, equipment, supplies, and manufactured articles, and for all labor, operations, and incidentals appurtenant to the items of Work being described, as necessary to complete the various items of the Work all in accordance with the requirements of the Contract Documents, including all appurtenances thereto, and including all costs of compliance with the regulations of public agencies having jurisdiction, including Safety and Health Administration of the U.S. Department of Labor (OSHA). No separate payment will be made for any item that is not specifically set forth in the Bid Schedules, and all costs therefore shall be included in the prices named in the Bid Schedules for the various appurtenant items of Work described in these Special Provisions and shown on the Plans.
- B. The Contracting Agency shall not pay for material quantities, which exceed the actual measured amount used and approved by the Engineer.
- C. It is the intention of these Specifications that the performance of all Work under the bid for each item shall result in the complete construction, in an accepted operating condition, of each item.
Work and material not specifically listed in the proposal but required in the Plans, Specifications, and general construction practice, shall be included in the bid price. No separate payment will be made for these incidental items.

1-09.14(2) Bid Items

Section 1-09.14(2) is a new section:

(*****)

This section describes the bid items. **Measurement and Payment, where described in a bid item, shall supersede Measurement and Payment listed in other sections of the Special Provisions and Standard Specifications.**

Several bid items listed below are included in Schedules A, B, and C. In no case shall any bid item that is installed be considered as part of more than one schedule:

- Schedule A: Work Associated with the Storm pipes, manholes, lateral connections, cleanouts, outfall, sidewalk and curb and gutter restoration, required asphalt restoration. This Schedule falls under State Sales Tax Rule 171 (see section 1-07.2(2)) and state retail sales taxes shall be included in bid items prices.
- Schedule B: Work Associated with the Sewer pipes, manholes, side sewers, and required asphalt restoration. This Schedule falls under State Sales Tax Rule 170 (see section 1-07.2(3)) and state retail sales taxes shall not be included in bid items prices. Rather, the Contractor shall collect retail sales tax on the full contract amount.
- Schedule C: Work Associated with the new Water lines, including pipeline, fittings, concrete blocking, utility relocations, sidewalk and curb and gutter restoration for the water main

work, and required asphalt restoration. This Schedule falls under State Sales Tax Rule 170 (see section 1-07.2(3)) and state retail sales taxes shall not be included in bid items prices. Rather, the Contractor shall collect retail sales tax on the full contract amount.

The following subsection provides the measurement and payment information of the Bid Items common to two or more schedules.

1-09.14(2)A Mobilization & Demobilization (Bid Item A-1, B-1 and C-1) – Lump Sum

Measurement for “Mobilization & Demobilization” will be lump sum. The lump sum price shown will cover the complete cost of furnishing and installing, complete and in-place all Work and materials necessary to move and organize equipment and personnel onto the job site, provide and maintain all necessary support facilities and utilities, obtain all necessary permits and licenses, prepare the site for construction operations, and maintain the site and surrounding areas during construction, provide protection of existing utilities, provide component and system testing, and move all personnel and equipment off the site after contract completion.

The Contractor shall prepare a Work Plan that shall include the following:

- A. Mobilization Plan showing the proposed location for storage of all equipment and materials. Storage shall not interfere with use of the City ROW and commercial and residential access. For any proposed storage on private property outside the easement or work area, the Contractor shall obtain a Temporary Use Permit for storage areas on private property. The Contractor shall be responsible for all fees, applications, and work needed to obtain the permit. The Contractor shall allow 3 to 4 weeks to obtain the Temporary Use Permit from the City.
- B. Temporary Erosion and Sediment Control Plan for all stages of the project
- C. Traffic Control Plan, including provisions for cleaning and sweeping of any impacted roadways.
- D. Trench Excavation Safety Systems plan/provisions.
- E. Identify Disposal Sites for various waste materials and provide copies of the site’s permits, licenses, and approvals.
- F. Pedestrian Handling Plan.

The Work Plan shall be submitted to the City for review and approval within 10 days of the contract award.

Payment for “Mobilization & Demobilization” will be made at the lump sum amount bid (NOT to exceed 80% of bid price prior to completion of construction) based on the percent of completed Work as defined in the 2020 Standard Specifications for Road, Bridge, and Municipal Construction (WSDOT) for mobilization. Payment for the remaining 20% will be made upon completion and final clean-up of the construction site. Such payment will be complete compensation for all mobilization of employees, equipment and materials, Mobilization Plan, Work Plan, preparation of all necessary submittals, bonds, insurance, site improvements, permits, clean-up, Contaminated Soil and Groundwater Handling and Management Plan, safety plan, and other plans/submittals not specifically covered in bid items, etc. all in conformance with the Contract Documents. **This bid item may not be more than ten percent (10%) of the total amount of Bid for the schedule.**

1-09.14(2)B Trench Safety Systems (Bid Item A-2, B-2 and C-2) – Lump Sum

Section 1-09.14(2)B is a new section:

(*****)

Measurement for “Trench Safety Systems” will be per the lump sum bid price based on a percentage defined as the amount of storm/sewer/water pipelines installed divided by the total length of sewer/storm/water pipe shown to be installed in conformance with the Contract Documents.

Payment for “Trench Safety Systems” will be made at the measured percentage amount for the pay period times the lump sum amount bid, said payment will be complete compensation for all equipment, labor, materials, hauling, planning, design, engineering, submittals, furnishing and constructing and removal and disposal of such temporary sheeting, shoring, and bracing complete as required under the provisions of any permits and in the requirements of OSHA and RCW Chapter 49.17, etc., required to complete this item of Work in conformance with the Contract Documents.

The work includes, but not limited to, preparing and submitting a shoring plan stamped by a professional engineer registered in the State of Washington by the preconstruction conference.

1-09.14(2)C Construction Surveying, Staking, and As-Built Drawings (Bid Item A-3, B-3, and C-3) – Lump Sum

Section 1-09.14(2)C is a new section:

(*****)

Measurement for “Construction Surveying, Staking and As-Built Drawings” information will be per the lump sum bid price and based on the percentage of total Work complete at the time of measurement.

Payment may be prorated over the construction period based on the amount of work completed for construction surveying, staking and as-built information.

Survey will be per Section 1-05.4 and Section 1-11. The as-built survey will be per Section 1-11. The contractor shall provide the City with a set of redline drawings with the as-built locations and elevations of all new utilities and construction work.

Payment will be complete compensation for all labor, materials, equipment, tools, all incidental work needed to provide construction surveying and of the improvements (including providing a Washington State licensed surveyor for said work), staking in advance of pipe laying, fittings and structure installation, surveying the horizontal and vertical locations of all potholed existing utilities within the work area, verification and recording of the elevations of existing roadway centerline, crown, and edge of pavement to ensure that all roadways can be reconstructed to existing grade, and preparation of cut-sheets. Said payment will be complete compensation for all labor, materials, equipment, tools, all incidental work needed to provide as-built surveying, preparing “red line” as-built drawings for pay estimate submittal with fittings and dimensions of existing and proposed facilities installed or encountered during the pay period, furnishing an electronic file with construction drawings stamped and signed by a licensed land surveyor that contains the as-built information and copies of field notes, and furnishing and resetting property corners when disturbed by the contractor’s activities. No more than 50% of the bid amount for this item shall be paid prior to the review and acceptance of the as-constructed information by the Engineer.

1-09.14(2)D Temporary Traffic Control (Bid Item A-4, B-4 and C-4) – Lump Sum

Section 1-09.14(2)D is a new section:

(*****)

Measurement for “Temporary Traffic Control” k will be will per the lump sum bid price and shall be based on the percentage of total Work complete, at the time of measurement in conformance with the Contract Documents.

Payment for “Temporary Traffic Control” will be made at the measured percentage amount for the pay period times the lump sum bid amount. Payment will be complete compensation for preparing and submitting a traffic control plan and pedestrian handling plan as well as all labor, tools, materials, equipment used in accordance with the approved Traffic Control Plan and pedestrian handling plan that is not included in other bid items. The Lump Sum contract price shall be full pay for all costs for performing the work described in Section 1-10.3), and in the Traffic Control Information. Payment shall include but not be limited to providing for public convenience and safety, flaggers, traffic control supervisor, construction signs, detours, barricades, sequential arrow boards, a minimum of two Portable Changeable Message Signs, traffic control devices, truck-mounted attenuator, temporary striping, cleanup, etc. required to complete this item of Work in conformance with the Contract Documents and the Manual on Uniform Traffic Control Devices (MUTCD) and as directed by the Engineer and by the City’s Transportation Department. Also, included in the contract price is the cost to furnish traffic control services and equipment for construction surveying, staking, and as-built plans.

All adjustments to the Traffic Control Plan are considered incidental, and no additional payment will be made for adjustments.

1-09.14(2)E Stormwater Pollution Prevention and TESC Plan and Implementation (Bid Item A-5, B-5 and C-5) – Lump Sum

Section 1-09.14(2)E is a new section:

(*****)

Measurement for “Stormwater Pollution Prevention and TESC Plan and Implementation” will be based on the lump sum bid price in conformance with the Contract Documents.

Temporary Erosion Control measures include inlet protection (catch basin inserts), cleaning catch basins, filter fabric fencing, construction entrance, straw mulch, plastic sheeting, etc. at a minimum. Other erosion control measures may be necessary depending on weather and site conditions, including but not limited to, hay bales, placement of plastic sheets over exposed soil and stockpiles, mulching, netting, etc., and any other activities needed to control erosion from the project.

The Contractor shall update the DRAFT Storm Water Pollution Prevention Plan, develop a "red lined" Temporary Erosion and Sediment Control plan and submit it to the City for review and approval. The plan shall be based on the *City of Renton Surface Water Design Manual*, and proper construction practices. After the erosion control system is installed the Contractor shall make any field adjustments necessary to reduce or eliminate any erosion and discharge of sediment-laden water. All adjustments are considered incidental and no additional payment will be made for adjustments.

The lump sum price for “Stormwater Pollution Prevention and TESC Plan and Implementation” shall be full pay for all labor, material, tools, equipment, and other incidental costs required to prepare the Stormwater Pollution Prevention Plan and Temporary Erosion and Sediment Control Plan as

described in Section 1-07.15 and implement the temporary erosion and sediment control BMP's including but not limited to installation, monitoring, and maintenance of sediment ponds, straw wattles, filter fabric fencing, pumping of construction water, coffer dams, temporary storm drain diversions including temporary piping, check dams, cover measures including plastic covering, street sweeping, collection and disposal of wastewater from asphalt and concrete cutting operations and other work necessary to meet the contract and permit requirements, not otherwise shown as a separate payment item. Payment shall also include the Contractor's use of Baker Tanks, as needed during construction and associated labor, tools, equipment and incidental costs including Baker Tank mobilization, set up, maintenance, and relocation as work progresses, and incidentals required to use Baker Tanks, when needed to meet regulatory discharge requirements.

Work shall include coordination, permitting, fees, and treatment required by King County as required in 1-07.15 if discharging to the sanitary sewer.

1-09.14(2)F Landscape Restoration (Bid Item A-6, B-6 and C-6) — Lump Sum

Section 1-09.14(2)F is a new section:

(*****)

Measurement for "Landscape Restoration" work will be based on the percentage of total Work complete, at the time of measurement in conformance with the Contract Documents.

Payment for "Landscape Restoration" will be made at the unit price bid per lump sum, which payment will be complete compensation for all labor, equipment, materials, hauling, excavation, sod, grass seed, topsoil, landscape bark, gravel, concrete, planting, preparation, compaction, watering, restoration, etc. required to restore landscaped, grass, and planted areas to an equal or better condition in conformance with the Contract Documents. It shall include but not be limited to the following:

- Hauling and disposing unsuitable, surplus and/or waste materials
- Replacing and restoring any landscaping, rockeries, walls, tree removal and replacement, trees, bark, and other improvements disturbed by construction activities, as directed by the Engineer
- Preparation, placement, and maintenance of 8" depth topsoil and lawn sod in conformance with the contract documents. All lawn areas shall be replaced with topsoil and sod. Bare areas shall be replaced at a minimum with mulch and seed.
- Site cleanup of all areas disturbed by contractor's activities to match the conditions as closely as existed prior to contractor's beginning work or as directed by the Engineer.

1-09.14(2)G Select Imported Trench Backfill (Bid Item A-7, B-7 and C-7) – Ton

Section 1-09.14(2)G is a new section:

(*****)

Measurement for "Select Imported Trench Backfill" will be measured in tons based on the weight of material installed into the Work in conformance with the Contract Documents. Certified weight tickets will accompany each load, a copy of tickets will be given to the Engineer daily. Wasted materials will not be included in the measurement or payment. Only materials placed within the pay limits shown will be considered for payment. Material placed outside of the pay limits shown on the Plans or as approved by the Engineer will be deducted from the certified tickets.

Payment for "Select Imported Backfill" will be made at the amount bid per ton, which payment will be complete compensation for all labor, materials, tools, equipment, incidentals necessary to furnish

and install select import backfill, hauling, placement, compaction, removal, haul and disposal of unsuitable excavated materials, waste and surplus materials, etc., required to complete this item of Work in conformance with the Contract Documents.

1-09.14(2)H Hot Mix Asphalt Patch Including CSTC (Bid Item A-8, B-8 and C-8) – Square Yard

Section 1-09.14(2)H is a new section:

(*****)

Measurement for “Hot Mix Asphalt Patch Including CSTC” shall be measured in Square Yards. Pavement repair measurement width shall be as defined by the limit of trench patch payment shown in the Contract Documents, unless otherwise approved by the Engineer. Wasted materials will not be included in the measurement or payment. Only materials placed within the pay limits shown will be considered for payment. Material placed outside of the pay limits shown on the plans or as approved by the Engineer will be deducted from the certified tickets.

Payment for “Hot Mix Asphalt Patch including CSTC” will be made at the amount bid per Square Yard, which payment will be complete compensation for all labor, materials, tools, equipment required to complete the work specified in the contract documents and plans, and shall include but not be limited to the following:

- Sawcutting, removal and disposal of existing pavement
- Placing and compacting crushed surfacing top course for utility trenches
- Furnishing, placing, and compacting hot mix asphalt materials for pavement repair
- Sealing all cold joints
- Tack coat
- Joint seal
- Asphalt Sidewalk Transitions
- Hauling
- Aggregate
- Sweeping
- Adjustment of utilities to grade
- Furnishing and preparing subgrade
- Cleanup
- All other incidentals necessary for a complete paving and restoring the roadway grade to existing elevations.

1-09.14(2)I Remove and Replace Concrete Sidewalk and Driveway (Bid Item A-9, B-9 and C-9) – Square Yard

Section 1-09.14(2)I is a new section:

(*****)

Measurement for “Remove and Replace Concrete Sidewalk and Driveway” will be based on square yard of concrete sidewalk and driveway, to match existing, restored to a saw-line line cut in conformance with the contract documents.

Payment for “Remove and Replace Concrete Sidewalk and Driveway” will be made at the unit price bid per square yard, which payment will be complete compensation for all labor, equipment, materials, tools and incidentals to remove and replace cement concrete driveway and sidewalk in conformance with the Contract Documents, and shall include but not be limited to the following:

- Sawcutting existing driveway, curb, sidewalk, and existing pavement

- Removal and disposal of surplus, unsuitable and/or waste materials
- Placing and compacting crushed surfacing top course for subgrade
- Furnishing and installing formwork
- Furnishing, placing, compacting, and finishing concrete for new driveway and/or sidewalk surface.

Gravel driveway and gravel parking areas, if existing, shall be restored under landscape restoration.

1-09.14(2)J Remove and Replace Concrete Curb and Gutter (Bid Item A-10, B-10 and C-10) – Linear Foot

Section 1-09.14(2)J is a new section:

(*****)

Measurement for “Remove and Replace Concrete Curb and Gutter” shall be per linear foot of curb repair required for installation of utilities in conformance with the Contract Documents.

Payment for “Remove and Replace Concrete Curb and Gutter” will be made at the amount bid per linear foot, which payment will be complete compensation for all labor, materials, tools, equipment required to complete the work specified in the Contract Documents, and shall include but not be limited to the following:

- Sawcutting, removal and disposal of existing curb and gutter
- Removal and disposal of surplus, unsuitable and /or waste materials
- Placing and compacting crushed surfacing top course for subgrade
- Furnishing and installing temporary formwork
- Furnishing and placing concrete and joint filler for new curb and gutter

1-09.14(2)K Replace Pavement Markings (Bid Item A-11, B-11 and C-11) – Lump Sum

Section 1-09.14(2)K is a new section:

(*****)

Measurement for “Replace Pavement Markings” will be per lump sum in conformance with the Contract Documents.

Payment for “Replace Pavement Markings” will be made at contract lump sum and constitute full compensation for all material, equipment, tools, labor and all else necessary for and incidental to re-establish existing pavement markings in accordance with the plans and specifications.

1-09.14(2)L Removal and Replacement of Unsuitable Foundation Material (Bid Item A-12, B-12 and C-12) – TON

Section 1-09.14(2)L is a new section:

(*****)

Measurement for “Removal and Replacement of Unsuitable Foundation Material” will be measured in Tons based on the placed weight of material installed in conformance with the Contract Documents. Placement of foundation material will be measured only for the area(s) authorized by the Engineer. Certified tickets will accompany each load, a copy of tickets will be given to the Engineer daily. Wasted materials will not be included in the measurement or payment.

Payment for “Removal and Replacement Of Unsuitable Foundation Material” will be made at the unit bid price, which will be complete compensation for all labor, materials, tools, equipment, excavation,

foundation materials, haul, placement, water, compaction, removal haul and disposal of waste material, etc., required to complete this item of Work in conformance with the Contract Documents.

Payment for this item will be only for the removal and replacement of unsuitable material requested by the City.

1-09.14(2)M CCTV Inspection (Bid Item A-13 and B-13) – Linear Foot

Section 1-09.14(2)M is a new section:

(*****)

Measurement for “CCTV inspection” will be per linear foot of storm and sanitary sewer pipe inspected in conformance with section 7-17.3(2)H and the Contract Documents.

Payment for “CCTV Inspection” will be made at the amount bid per linear foot, which payment will be complete compensation for all labor, materials, equipment required to complete the work specified in the Contract Documents, and shall include but not be limited to the following:

- Bypass sewer pumping (if needed),
- CCTV inspection of all new open-cut installed storm and sanitary sewers,
- Delivery of the CCTV inspections entirely in a PACP compatible format data base on an External HDD or USB flash drive to the Engineer.

Costs for additional Television Inspection required to verify corrections or replacement of pipe, or done solely for the Contractor's convenience, shall be at the Contractor's sole expense.

1-09.14(2)N Site Specific Utility Potholing (Bid Item A-14 and C-13) – Each

Section 1-09.14(2)N is a new section:

(*****)

Measurement for “Site Specific Potholing” will be per each for each location shown on the engineering drawings, or as directed by the Engineer. Work shall be performed in conformance with the Contract Documents (see Section 1-07.17(3) for Site Specific Potholing).

Payment for “Site Specific Potholing” will be made at the unit price bid per each, which payment will be complete compensation for all labor, tools, equipment, and materials required to complete the work in conformance with the Contract Documents including but not limited to pavement and concrete cutting, excavation, dewatering, potholing for utility location, removal, hauling and disposal of all pavement, waste and excess materials, shoring, relocating or coordinating relocation of the unknown utility, placement of backfill (native) material, compaction, water, grading, temporary patch, and cleaning. Payment also includes all temporary traffic control operations, utility one-call and, coordination with utility owner, and temporary restoration work associated with potholing.

If the native material is unsuitable to use to refill the pothole, imported backfill may be used. Imported backfill will be paid under a separate bid item. Permanent pavement patch will be paid under a separate bid item.

Prior to beginning construction of the new underground utility, the Contractor shall pothole the existing underground utilities at the locations required by the Plans, or as identified by the Engineer. The Contractor shall perform potholing a minimum of ten (10) working days prior to construction at the pothole location to allow for potential revisions. The City shall have ten (10) working days after

receiving the written results to make any design revisions to the plans, if needed. The Engineer may revise the design as needed if there is a conflict with existing utilities.

The Contractor shall not have cause for claim of downtime or any other additional costs associated with “waiting” if the City provides design revisions (related to the information supplied per this section) within ten (10) working days after the Contractor provides the written potholing results.

1-09.14(2)O Replace Survey Monument (Bid Item A-15 and C-14) – Each

Section 1-09.14(2)O is a new section:

(*****)

“Replace Survey Monument” shall be per Section 1-05.4 and Section 1-11. The surveyor shall comply with WAC 332-120 Survey Monuments – Removal or Destruction. Contractor shall contact the City of Renton’s Property & Technical Services Manager prior to performing work.

The work includes, but is not limited to:

- A. Locating and surveying all existing monuments, and providing the City with a copy of the survey results.
- B. Providing the City with a copy of the Application to Remove a Monument submitted to the State DNR for each monument.
- C. Resetting the monuments in the original positions, or setting witness monuments if needed. All new monuments, discs, materials, and the work needed to set them are included.
- D. Providing the City with a copy of the Completion Report submitted to the State DNR for each monument.
- E. Submitting a City Monument Card to the City showing the new monument and monument ties. Existing monument ties will be used whenever possible. New ties shall be set where needed. New monuments and monument cards are subject to City review and approval. Any corrections or resurveying needed shall be incidental.
- F. All work shall be located per the City of Renton Survey Control Network. Coordinates shall be given for the new and existing monument.

Measurement for “Replace Survey Monument” shall be per each survey monument replaced, including each witness monument placed (if needed). This bid item shall also be used for new survey monument where required on the plans.

Payment for “Replace Survey Monument” will be complete compensation for all labor, materials, equipment, travel, surveying, documentation, permits, and replacement of each survey monument as shown on the plans required to complete this item of work in conformance with the Contract Documents.

Up to 50 percent of the unit bid price for each monument will be paid after each existing monument is surveyed, and the City receives a copy of the Application to Remove a Monument submitted to the State DNR.

The remaining 50 percent of the unit bid price for each monument will be paid after each new monument is placed, a copy of the Completion Report and a new Monument Card is submitted to the City, and the City review and acceptance of the new monument and Monument Card.

The following subsection provides the measurement and payment information of the Bid Items specific to Schedule A – Storm Water.

1-09.14(2)AA Stormwater Minor Changes (Bid Item A-16) – Estimated

Section 1-09.14(2)AA is a new section:

(*****)

For the purpose of providing a common proposal for all bidders, the Contracting Agency has entered an amount for “Stormwater Minor Change” in the Proposal to become a part of the total bid by the Contractor. At the discretion of the Contracting Agency, all or part of this estimated amount may be used in lieu of the more formal procedure as outlined in Section 1-04. The unit contract price for Minor Changes is given in the Schedule of Prices and shall not be changed by the bidder.

All work and payment under this item will be authorized in writing by the City Project Manager or Manager. Payment will be determined in accordance with Section 1-09.4.

Payment for this item will be only for the changes and amounts approved by the City.

If no changes are authorized under this bid item final payment for this item will be \$0 (zero).

1-09.14(2)AB Resolution of Utility Conflicts with Stormwater (Bid Item A-17) – Force Account

Section 1-09.14(2)AB is a new section:

(*****)

Payment will be made at the discretion of the Engineer, for the following bid item(s) in accordance with Section 1-09.6 when included in the Proposal:

"Resolution of Utility Conflicts with Stormwater," per Force Account.

In no way shall the work described under “Resolution of Utility Conflicts” relieve Contractor of any of the responsibilities described in Section 1-07.17, and elsewhere in the Contract Documents.

Resolution of utility conflicts is included as a bid item for use in resolving any new identified utility conflicts not otherwise shown on the Contract Drawing or Specifications that are identified during the course of construction. Resolution of conflicts with gas services, water services, and sewer services shall be incidental to other pay items.

To provide a common basis for all bidders, the Contracting Agency has entered an amount for the item “Resolution of Utility Conflicts with Stormwater” in the Proposal to become a part of the total bid by the Contractor. Payment for this item will be only for the changes and amounts approved by the City. If no changes are authorized under this bid item, final payment for this item will be \$0 (zero).

1-09.14(2)AC Construction Geotextile For Separation Bid Item A-18) – Square Yard

Section 1-09.14(2)AC is a new section:

(*****)

Measurement for “Construction Geotextile For Separation” will be per square yard installed as measured by the length installed by the standard width of the trench/sections as shown on the Plans. All use of geotextile shall be pre-approved by the Engineer.

Payment will be made at contract unit price and will constitute full compensation for all material, equipment, tools, labor, and all necessary for and incidental to the installation of geotextile in

accordance with the Contract Documents and as directed by the Engineer. The geotextile bid item is exempt from Section 1-04.6 and no price adjustment will be made for variation in actual quantity used.

The “Construction Geotextile for Separation” bid item is exempt from Section 1-04.6 and no price adjustment will be made for variation in actual quantity used.

1-09.14(2)AD Storm Drain, 6-inch Diameter [CPEP] (Bid Item A-19) – Linear Foot

Section 1-09.14(2)AD is a new section:

(*****)

Measurement for “Storm Drain Pipe, 6-in Diameter [CPEP]” will be based on linear foot measured horizontally over the centerline of the installed pipe from the center of structures in conformance with the Contract Documents.

Payment for furnishing and installing “Storm Drain Pipe, 6-in Diameter [CPEP]” will be made at the amount bid per linear foot, which payment will be complete compensation for:

- All labor, materials, equipment and hauling
- Locating all existing utilities and potholing in advance to determine their horizontal and vertical location, protecting and providing temporary support of existing utilities
- Pavement cutting (sawcutting), pavement removal and excavation
- Dewatering, temporary bypass pumping and control of water
- Removal and disposal of waste material in the excavation necessary to construct the improvements including but not limited to: existing pipes; catch basins; manholes; structures; and abandoned utilities
- Pipe of the size and material type required, gaskets, fittings and adaptors
- Installation, laying and jointing pipe and fittings
- Furnishing and placing pipe zone bedding material
- Furnishing, placement and compaction of imported trench backfill
- Appurtenances, ethafoam pads, water, grading, cleaning, and testing, etc. required to complete the work in accordance with the Contract Documents
- Removal of pipe and catch basins beyond the excavation where shown on the Drawings or where directed by the Engineer as well as plugging existing pipes to be abandoned and plugging existing pipes where sections have been removed for the storm installation, and providing end caps were shown on the plans. These items shall not be limited to those mentioned on the Plans or specified herein.
- Replacing, protecting and/or maintaining existing utilities
- Furnishing and placing temporary pavement patching.

Contractor is advised that year-round groundwater seeps entering the drainage system must be controlled and bypassed and shall be paid for as a part of this bid item.

Select Imported Trench Backfill above the pipe zone bedding is included in other bid items.

1-09.14(2)AE Storm Drain, 8-inch Diameter [CPEP] (Bid Item A-20) – Linear Foot

Section 1-09.14(2)AE is a new section:

(*****)

Measurement for “Storm Drain Pipe, 8-in Diameter [CPEP]” will be based on linear foot measured horizontally over the centerline of the installed pipe from the center of structures in conformance with the Contract Documents.

Payment for furnishing and installing “Storm Drain Pipe, 8-in Diameter [CPEP]” will be made at the amount bid per linear foot, which payment will be complete compensation for:

- All labor, materials, equipment and hauling
- Locating all existing utilities and potholing in advance to determine their horizontal and vertical location, protecting and providing temporary support of existing utilities
- Pavement cutting (sawcutting), pavement removal and excavation
- Dewatering, temporary bypass pumping and control of water
- Removal and disposal of waste material in the excavation necessary to construct the improvements including but not limited to: existing pipes; catch basins; manholes; structures; and abandoned utilities
- Pipe of the size and material type required, gaskets, fittings and adaptors
- Installation, laying and jointing pipe and fittings
- Furnishing and placing pipe zone bedding material
- Furnishing, placement and compaction of imported trench backfill
- Appurtenances, ethafoam pads, water, grading, cleaning, and testing, etc. required to complete the work in accordance with the Contract Documents.
- Removal of pipe and catch basins beyond the excavation where shown on the Drawings or where directed by the Engineer as well as plugging existing pipes to be abandoned and plugging existing pipes where sections have been removed for the storm installation, and providing end caps were shown on the plans. These items shall not be limited to those mentioned on the Plans or specified herein.
- Replacing, protecting, and/or maintaining existing utilities
- Furnishing and placing temporary pavement patching.

Contractor is advised that year-round groundwater seeps entering the drainage system must be controlled and bypassed and shall be paid for as a part of this bid item.

Select Imported Trench Backfill above the pipe zone bedding is included in other bid items.

1-09.14(2)AF Storm Drain, 8-inch Diameter [DI] (Bid Item A-21) – Linear Foot

Section 1-09.14(2)AF is a new section:

(*****)

Measurement for Storm “Drain Pipe, 8-in Diameter [DI]” will be based on linear foot measured horizontally over the centerline of the installed pipe from the center of structures in conformance with the Contract Documents.

Payment for furnishing and installing “Storm Drain Pipe, 8-in Diameter [DI]” will be made at the amount bid per linear foot, which payment will be complete compensation for:

- All labor, materials, equipment and hauling

- Locating all existing utilities and potholing in advance to determine their horizontal and vertical location, protecting and providing temporary support of existing utilities
- Pavement cutting (sawcutting), pavement removal and excavation
- Dewatering, temporary bypass pumping and control of water
- Removal and disposal of waste material in the excavation necessary to construct the improvements including but not limited to: existing pipes; catch basins; manholes; structures; and abandoned utilities
- Pipe of the size and material type required, gaskets, fittings and adaptors
- Installation, laying and jointing pipe and fittings
- Furnishing and placing pipe zone bedding material
- Furnishing, placement and compaction of imported trench backfill
- Appurtenances, ethafoam pads, water, grading, cleaning, and testing, etc. required to complete the work in accordance with the Contract Documents.
- Removal of pipe and catch basins beyond the excavation where shown on the Drawings or where directed by the Engineer as well as plugging existing pipes to be abandoned and plugging existing pipes where sections have been removed for the storm installation, and providing end caps were shown on the plans. These items shall not be limited to those mentioned on the Plans or specified herein.
- Replacing, protecting and/or maintaining existing utilities
- Furnishing and placing temporary pavement patching.

Contractor is advised that year-round groundwater seeps entering the drainage system must be controlled and bypassed and shall be paid for as a part of this bid item.

Select Imported Trench Backfill above the pipe zone bedding is included in other bid items.

1-09.14(2)AG Storm Drain, 12-inch Diameter [PPP] (Bid Item A-22) – Linear Foot

Section 1-09.14(2)AG is a new section:

(*****)

Measurement for “Storm Drain Pipe, 12-in Diameter [PPP]” will be based on linear foot measured horizontally over the centerline of the installed pipe from the center of structures in conformance with the Contract Documents.

Payment for furnishing and installing Storm Drain Pipe, 12-in Diameter [PPP] will be made at the amount bid per linear foot, which payment will be complete compensation for:

- All labor, materials, equipment and hauling
- Locating all existing utilities and potholing in advance to determine their horizontal and vertical location, protecting and providing temporary support of existing utilities
- Pavement cutting (sawcutting), pavement removal and excavation
- Dewatering, temporary bypass pumping and control of water
- Removal and disposal of waste material in the excavation necessary to construct the improvements including but not limited to: existing pipes; catch basins; manholes; structures; and abandoned utilities
- Pipe of the size and material type required, gaskets, fittings and adaptors
- Installation, laying and jointing pipe and fittings
- Furnishing and placing pipe zone bedding material
- Furnishing, placement and compaction of imported trench backfill

- Appurtenances, ethafoam pads, water, grading, cleaning, and testing, etc. required to complete the work in accordance with the Contract Documents.
- Removal of pipe and catch basins beyond the excavation where shown on the Drawings or where directed by the Engineer as well as plugging existing pipes to be abandoned and plugging existing pipes where sections have been removed for the storm installation, and providing end caps were shown on the plans. These items shall not be limited to those mentioned on the Plans or specified herein.
- Replacing, protecting and/or maintaining existing utilities
- Furnishing and placing temporary pavement patching.

Contractor is advised that year-round groundwater seeps enter the drainage system must be controlled and bypassed and shall be paid for as a part of this bid item.

Select Imported Trench Backfill above the pipe zone bedding is included in other bid items.

1-09.14(2AH Storm Drain, 12-inch Diameter [DI] (Bid Item A-23) – Linear Foot

Section 1-09.14(2)AH is a new section:

(*****)

Measurement for “Storm Drain Pipe, 12-in Diameter [DI]” will be based on linear foot measured horizontally over the centerline of the installed pipe from the center of structures in conformance with the Contract Documents.

Payment for furnishing and installing “Storm Drain Pipe, 12-in Diameter [DI]” will be made at the amount bid per linear foot, which payment will be complete compensation for:

- All labor, materials, equipment and hauling
- Locating all existing utilities and potholing in advance to determine their horizontal and vertical location, protecting and providing temporary support of existing utilities
- Pavement cutting (sawcutting), pavement removal and excavation
- Dewatering, temporary bypass pumping and control of water
- Removal and disposal of waste material in the excavation necessary to construct the improvements including but not limited to: existing pipes; catch basins; manholes; structures; and abandoned utilities
- Pipe of the size and material type required, gaskets, fittings and adaptors
- Installation, laying and jointing pipe and fittings
- Furnishing and placing pipe zone bedding material
- Furnishing, placement and compaction of imported trench backfill
- Appurtenances, ethafoam pads, water, grading, cleaning, and testing, etc. required to complete the work in accordance with the Contract Documents
- Removal of pipe and catch basins beyond the excavation where shown on the Drawings or where directed by the Engineer as well as plugging existing pipes to be abandoned and plugging existing pipes where sections have been removed for the storm installation, and providing end caps were shown on the plans. These items shall not be limited to those mentioned on the Plans or specified herein.
- Replacing, protecting and/or maintaining existing utilities
- Furnishing and placing temporary pavement patching.

Contractor is advised that year-round groundwater seeps enter the drainage system must be controlled and bypassed and shall be paid for as a part of this bid item.

Select Imported Trench Backfill above the pipe zone bedding is included in other bid items.

1-09.14(2)AI Trench Drain (Bid Item A-24) – Linear Foot

Section 1-09.14(2)AI is a new section:

(*****)

Measurement for “Trench Drain” will be based on linear foot measured horizontally over the centerline of the trench drain installed as measured from the end of the grates in conformance with the Contract Documents.

Payment for furnishing and installing “Trench Drain” will be made at the amount bid per linear foot, which payment will be complete compensation for:

- All labor, materials, equipment and hauling
- Locating all existing utilities and potholing in advance to determine their horizontal and vertical location, protecting and providing temporary support of existing utilities
- Pavement/concrete cutting (sawcutting), pavement removal and disposal, concrete curb and gutter removal and disposal and excavation
- Dewatering, temporary bypass pumping and control of water
- Removal and disposal of waste material in the excavation necessary to construct the improvements including but not limited to; existing pipes; structures; and abandoned utilities
- Placing and compacting crushed surfacing top course bedding, trench drain and grate, replacement concrete curb, connecting pipe at termination of trench drain, gaskets, fittings and adaptors, installation, laying and jointing trench drain and fittings
- Appurtenances, ethafoam pads
- Placement of backfill material, compaction, water and grading, submittals, cleaning, and testing, etc. required to complete the work in accordance with the Contract Documents.
- Furnishing and placing temporary pavement patching

Select Imported Trench Backfill used as backfill for the Trench Drain is included in other bid items.

1-09.14(2)AJ Connect Existing Lateral to New Storm Pipe (Bid Item A-25) – Each

Section 1-09.14(2)AJ is a new section:

(*****)

Measurement for “Connect Existing Lateral to New Storm Pipe” will be per each in conformance with Contract Documents.

Payment for connect existing lateral to new storm pipe will be made at the unit price per each, which will be complete compensation for all labor, equipment, materials, excavation around and protection of existing pipe, cleaning the existing pipe, pipe sleeve or other fittings required to connect to existing pipe, and removal and disposal of waste material.

Pipe material shall be under separate item.

1-09.14(2)AK Connect New Storm Pipe to Existing Catch Basin (Bid Item A-26) – Each

Section 1-09.14(2)AK is a new section:

(*****)

Measurement for “Connect New Storm Pipe to Existing Catch Basin” will be per each in conformance with Contract Documents.

Payment for “Connect New Storm Pipe to Existing Catch Basin” will be made at the unit price per each, which will be complete compensation for all labor, equipment, materials, excavation around and protection of existing structure, core drilling, cleaning the existing catch basin and other materials required to connect to existing catch basin.

1-09.14(2)AL Storm Lateral Cleanout - 6” or 8” Diameter (Bid Item A-27) – Each

Section 1-09.14(2)AL is a new section:

(*****)

Measurement for “Storm Lateral Cleanout – 6” or 8” Diameter” will be per each in conformance with Contract Documents. City may require an 8” diameter cleanout for an existing 6” lateral.

Payment for “Storm Lateral Cleanout – 6” or 8” Diameter” will be made at the unit price per each, which will be complete compensation for all labor, equipment, materials, excavation around and protection of existing pipe, bedding, pipe associated with the cleanout riser including wye connection to lateral, pipe reducer fitting if transitioning from 6” to 8”, or other fittings/couplings required to connect to existing main pipe, removal and disposal of waste material, cast iron ring and cover, watertight plug, concrete pad, and furnishing and placing temporary pavement patching.

1-09.14(2)AM Catch Basin Type 1 (Bid Item A-28) – Each

Section 1-09.14(2)AM is a new section:

(*****)

Measurement for furnishing and installing “Catch Basin Type 1” will be per each for each catch basin installed in conformance with the Contract Documents.

Payment for furnishing and installing “Catch Basin Type 1” will be made at the unit bid price per each, which will be complete compensation for:

- All labor, equipment, materials, and hauling
- Locating all existing utilities and potholing in advance to determine their horizontal and vertical location, protecting and providing temporary support of existing utilities
- Pavement cutting (sawcutting), pavement removal, excavation and shoring
- Dewatering, temporary bypass pumping and control of water
- Removal and disposal of waste material including existing pipes and structures in the excavation and any abandoned utilities
- Furnishing and placing foundation material
- Precast concrete catch basin, gaskets, catch basin frame and lid, installation, adjustment of frames to grade, appurtenances, Kor-N-Seal boots (or approved equal), connections to new pipes, reconnections to existing pipes including pipe and couplings, placement of subsequent backfill materials, compaction, water, cleaning, and testing, etc. required in conformance with the Contract Documents.
- Furnishing and placing temporary pavement patching

Select imported backfill material is included in other bid items. Maximum pay limit for select imported backfill material around structures shall be limited to 3-feet.

1-09.14(2)AN Catch Basin Type 1L with Special Frame and Grate (Bid Item A-29) – Each

Section 1-09.14(2)AN is a new section:

(*****)

Measurement for furnishing and installing “Catch Basin Type 1L” with special grate will be per each for each catch basin installed in conformance with the Contract Documents.

Payment for furnishing and installing “Catch Basin Type 1L” with special grate will be made at the unit bid price per each, which will be complete compensation for:

- All labor, equipment, materials, and hauling
- Locating all existing utilities and potholing in advance to determine their horizontal and vertical location, protecting and providing temporary support of existing utilities
- Pavement cutting (sawcutting), pavement removal, excavation and shoring
- Dewatering, temporary bypass pumping and control of water
- Removal and disposal of waste material including existing pipes and structures in the excavation and any abandoned utilities
- Furnishing and placing foundation material
- Precast concrete catch basin, gaskets, catch basin frame and lid, installation, adjustment of frames to grade, appurtenances, Kor-N-Seal boots (or approved equal), connections to new pipes, reconnections to existing pipes including pipe and couplings, placement of subsequent backfill materials, compaction, water, cleaning, and testing, etc. required in conformance with the Contract Documents.
- Furnishing and placing temporary pavement patching

Select imported backfill material is included in other bid items. Maximum pay limit for select imported backfill material around structures shall be limited to 3-feet.

1-09.14(2)AO Catch Basin Type 2, 48-inch Diameter (Bid Item A-30) – Each

Section 1-09.14(2)AO is a new section:

(*****)

Measurement for “Catch Basin Type 2, 48-inch Diameter” will be measured per each installed in conformance with the Contract Documents.

Payment for “Catch Basin Type 2, 48-inch Diameter” will be made at the contract unit price and will constitute full compensation for:

- All labor, equipment, materials, and hauling
- Locating all existing utilities and potholing in advance to determine their horizontal and vertical location, protecting and providing temporary support of existing utilities
- Pavement cutting (sawcutting), pavement removal, excavation and shoring
- Dewatering, temporary bypass pumping and control of water
- Removal and disposal of waste material including existing pipes and structures in the excavation and any abandoned utilities
- Furnishing and placing foundation material
- Precast concrete catch basin, gaskets, catch basin frame and lid, installation, adjustment of frames to grade, appurtenances, Kor-N-Seal boots (or approved equal), connections to new

pipes, reconnections to existing pipes including pipe and couplings, placement of subsequent backfill materials, compaction, water, cleaning, and testing, etc. required in conformance with the Contract Documents.

- Furnishing and placing temporary pavement patching

Select imported backfill material is included in other bid items. Maximum pay limit for select imported backfill material around structures shall be limited to 3-feet.

1-09.14(2)AP Controlled Density Fill (Bid Item A-31) – Cubic Yard

Section 1-09.14(2)AP is a new section:

(*****)

Measurement for “Control Density Fill” will be per cubic yard in conformance with the Contract Documents. All use of CDF shall be pre-approved by the Engineer. CDF used beyond the agreed amount or CDF used without prior Engineer approval will not be paid.

Payment for “Control Density Fill” will be made at contract unit price and will constitute full compensation for all material, equipment, tools, labor, and all necessary for and incidental to the installation of Control Density Fill in accordance with the Contract Documents and as directed by the Engineer.

Payment for this item will be only for the control density fill pre-approved by the City. If no control density fill is authorized under this bid item, final payment for this item will be \$0 (zero). The control density fill bid item is exempt from Section 1-04.6 and no price adjustment will be made for variation in actual quantity used.

The Control Density Fill bid item is exempt from Section 1-04.6 and no price adjustment will be made for variation in actual quantity used.

1-09.14(2)AQ Sewer Service Relocation for Stormwater Conflict (Bid Item A-32) – Each

Section 1-09.14(2)AQ is a new section:

(*****)

Measurement for “Sewer Service Relocation for Stormwater Conflict” will be per each in conformance with Contract Documents. Only those sewer service relocations authorized by the City in advance will be paid.

Payment for “Sewer Service Relocation for Stormwater Conflict” will be made at the unit price per each, which will be complete compensation for all labor, equipment, material, to relocate an existing side sewer service to avoid a conflict with the new storm, including but not limited to hauling, sawcutting, excavation, dewatering, temporary control of sewer or sewer bypass pumping, removal and disposal of waste material including existing sewer service piping, pipe of the size and material type required, gaskets, fittings and adaptors, installation, laying and jointing pipe and fittings, furnishing and placing pipe zone bedding material and pipe zone fill material, appurtenances, placement of subsequent backfill materials, compaction, water, grading, cleaning, and testing, etc. required to complete the work in accordance with the Contract Documents. Select Imported Trench Backfill above the pipe zone bedding, if used, is included in other bid items.

There shall be no separate payment for adjusting the new storm pipe profile to avoid a conflict with the sewer. This shall be considered incidental to other bid items.

To provide a common basis for all bidders, the Contracting Agency has entered a quantity for this bid item, however, the actual quantity is unknown and may be zero. If no sewer service relocation for stormwater conflicts are authorized under this bid item, final payment for this item will be \$0 (zero).

1-09.14(2)AR Abandon Existing Manhole (Bid Item A-33) — Each

Section 1-09.14(2)AR is a new section:

(*****)

Measurement for “Abandon Existing Manhole” will be per each performed in conformance with the Contract Documents.

The unit price per each for “Abandon Existing Manhole” shall be full pay for all labor, equipment, material, and equipment to plug pipe connections, remove and dispose of top 4 feet of structure and filling remaining structure with sand in accordance with the standard specifications. The ring and cover shall be salvaged if requested by the City.

The following subsection provides the measurement and payment information of the Bid Items specific to Schedule B – Wastewater.

1-09.14(2)BA Furnish and Install 8-inch PVC Sewer Pipe (Bid Item B-14) — Linear Foot

Section 1-09.14(2)BA is a new section:

(*****)

Measurement for “Furnish and Install 8-Inch PVC Sewer Pipe” will be based on linear footage measured horizontally over the centerline of the installed pipe.

Payment for “Furnish And Install 8-Inch PVC Sewer Pipe” will be made at the amount bid per linear foot, which payment will be complete compensation for all labor, materials, equipment required to complete the work specified in the Contract Documents, and shall include but not be limited to the following:

- Locating all existing utilities and potholing in advance to determine their horizontal and vertical location, including potholing in advance for existing side sewers and television inspection of existing sanitary sewer to determine location of side sewer branches if necessary.
- Saw cutting up to 12” in depth, trench excavation, and dewatering (if needed),
- Bypass sewer pumping (if needed),
- Removal, hauling and disposal of waste materials including but not limited to pavement, curbs, gutters, sidewalks, surplus and unsuitable excavated material, existing pipes and structures in the excavation
- Furnishing, installing, laying and joining sewer pipes and fittings of the size and type shown, and all incidentals,
- Ethafoam pads (when needed),
- Furnishing bedding materials, placing and compacting pipe bedding, as shown on the plans,
- Placing and compacting trench backfill,
- Air-Testing (if required)
- Replacing, protecting and/or maintaining existing utilities,
- Furnishing and Placing Temporary Pavement Patching.

1-09.14(2)BB Furnish and Install 8-inch HDPE Sewer Pipe (Bid Item B-15) — Linear Foot

Section 1-09.14(2)BB is a new section:

(*****)

Measurement for “Furnish and Install 8-Inch HDPE Sewer Pipe” will be based on linear footage measured horizontally over the centerline of the installed pipe.

Payment for “Furnish And Install 8-Inch HDPE Sewer Pipe” will be made at the amount bid per linear foot, which payment will be complete compensation for all labor, materials, equipment required to complete the work specified in the Contract Documents, and shall include but not be limited to the following:

- Locating all existing utilities and potholing in advance to determine their horizontal and vertical location, including potholing in advance for existing side sewers and television inspection of existing sanitary sewer to determine location of side sewer branches if necessary.
- Saw cutting up to 12” in depth, trench excavation, and dewatering (if needed),
- Bypass sewer pumping (if needed),
- Removal, hauling and disposal of waste materials including but not limited to pavement, curbs, gutters, sidewalks, surplus and unsuitable excavated material, existing pipes and structures in the excavation,
- Furnishing, installing, laying and joining sewer pipes, fittings and couplings of the size and type shown, and all incidentals,
- Ethafoam pads (when needed),
- Furnishing bedding materials, placing and compacting pipe bedding, as shown on the plans,
- Placing and compacting trench backfill,
- Air-Testing (if required)
- Replacing, protecting and/or maintaining existing utilities,
- Furnishing and Placing Temporary Pavement Patching.

1-09.14(2)BC Furnish and Install 10-inch PVC Sewer Pipe (Bid Item B-16) — Linear Foot

Section 1-09.14(2)BC is a new section:

(*****)

Measurement for “Furnish and Install 10-Inch PVC Sewer Pipe” will be based on linear footage measured horizontally over the centerline of the installed pipe.

Payment for “Furnish And Install 10-Inch PVC Sewer Pipe” will be made at the amount bid per linear foot, which payment will be complete compensation for all labor, materials, equipment required to complete the work specified in the Contract Documents, and shall include but not be limited to the following:

- Locating all existing utilities and potholing in advance to determine their horizontal and vertical location, including potholing in advance for existing side sewers and television inspection of existing sanitary sewer to determine location of side sewer branches if necessary.
- Saw cutting up to 12” in depth, trench excavation, and dewatering (if needed),
- Bypass sewer pumping (if needed),

- Removal, hauling and disposal of waste materials including but not limited to pavement, curbs, gutters, sidewalks, surplus and unsuitable excavated material, existing pipes and structures in the excavation,
- Furnishing, installing, laying and joining sewer pipes, fittings and couplings of the size and type shown, and all incidentals,
- Ethafoam pads (when needed),
- Furnishing bedding materials, placing and compacting pipe bedding, as shown on the plans,
- Placing and compacting trench backfill,
- Air-Testing (if required)
- Replacing, protecting and/or maintaining existing utilities,
- Furnishing and Placing Temporary Pavement Patching.

1-09.14(2)BD Furnish and Install 6-inch PVC Side Sewer Pipe (Bid Item B-17) — Linear Foot

Section 1-09.14(2)BD is a new section:

(*****)

Measurement for “Furnish and Install 6-Inch PVC Side Sewer Pipe” will be based on linear footage measured horizontally over the centerline of the installed pipe.

Payment for “Furnish And Install 6-Inch PVC Side Sewer Pipe” will be made at the amount bid per linear foot, which payment will be complete compensation for all labor, materials, equipment required to complete the work specified in the Contract Documents, and shall include but not be limited to the following:

- Locating all existing utilities and potholing in advance to determine their horizontal and vertical location, including potholing in advance for existing side sewers and television inspection of existing sanitary sewer to determine location of side sewer branches if necessary.
- Saw cutting up to 12” in depth, trench excavation, and dewatering (if needed),
- Bypass sewer pumping (if needed),
- Removal, hauling and disposal of waste materials including but not limited to pavement, curbs, gutters, sidewalks, surplus and unsuitable excavated material, existing pipes and structures in the excavation,
- Furnishing, installing, laying and joining sewer pipes, fittings and couplings of the size and type shown, and all incidentals,
- Furnishing and installing cleanout frame and cover,
- Furnishing and installing concrete around cleanout frame (as required by the project plans),
- Ethafoam pads (when needed),
- Furnishing bedding materials, placing and compacting pipe bedding, as shown on the plans,
- Placing and compacting trench backfill,
- Air-Testing (if required)
- Replacing, protecting and/or maintaining existing utilities,
- Furnishing and Placing Temporary Pavement Patching.

1-09.14(2)BE Furnish and Install 4-inch or 6-inch CIPP Side Sewer Pipe (Bid Item B-18) — Each

Section 1-09.14(2)BE is a new section:

(*****)

Measurement for Furnish and Install 4- inch or 6-Inch CIPP Side Sewer Pipe will be based on linear footage measured horizontally over the centerline of the installed pipe.

Payment for “Furnish And Install 4-inch or 6-Inch CIPP Side Sewer Pipe” will be made at the amount bid per linear foot, which payment will be complete compensation for all labor, materials, equipment required to complete the work specified in the Contract Documents, and shall include but not be limited to the following:

- Equipment and tools need to confirm size and suitability for lining of each side sewer stub as shown on the project plans,
- Saw cutting up to 12” in depth, trench excavation, and dewatering (if needed),
- Bypass sewer pumping (if needed),
- Removal, hauling and disposal of waste materials including but not limited to pavement, curbs, gutters, sidewalks, surplus and unsuitable excavated material, existing pipes and structures in the excavation,
- Furnishing and installing the CIPP sewer pipes of the size necessary,
- Post installation CCTV Inspection.

1-09.14(2)BF Furnish and Install Internal Sewer Drop in Existing Manhole (Bid Item B-19) — Each

Section 1-09.14(2)BF is a new section:

(*****)

Measurement for “Furnish and Install Internal Sewer Drop in Existing Manhole” will be per each for each internal sewer drop installed in conformance with the Contract Documents.

Payment for “Furnish And Install Internal Sewer Drop in Existing Manhole” will be made at the amount bid per each, which payment will be complete compensation for all labor, materials, equipment required to complete the work specified in the Contract Documents, and shall include but not be limited to the following:

- Locating all existing utilities and potholing in advance to determine their horizontal and vertical location, including potholing in advance for existing side sewers and television inspection of existing sanitary sewer to determine location of side sewer branches if necessary.
- Saw cutting up to 12” in depth, trench excavation, and dewatering (if needed),
- Bypass sewer pumping (if needed),
- Removal, hauling and disposal of waste materials including but not limited to pavement, curbs, gutters, sidewalks, surplus and unsuitable excavated material, existing pipes and structures in the excavation,
- Furnishing, installing, joining and attaching sewer pipes, fittings, couplings and mounting brackets of the size and type shown for the internal drop, and all incidentals,
- Core-drilling of the existing manhole and installation of a Kor-N-Seal boot (or approved equal),
- Furnishing and installing concrete and aggregate for plugging existing outside drop,
- Furnishing bedding materials, placing and compacting pipe bedding, as shown on the plans,
- Placing and compacting trench backfill,
- Replacing, protecting and/or maintaining existing utilities,
- Furnishing and Placing Temporary Pavement Patching.

1-09.14(2)BG Furnish and Install Sanitary Sewer Manhole Extra Shallow (Bid Item B-20) — Each

Section 1-09.14(2)BG is a new section:

(*****)

Measurement for “Furnish and Install Shallow Sanitary Sewer Manhole Extra Shallow” will be per each for each type manhole installed in conformance with the Contract Documents.

Payment for “Furnish And Install Shallow Sanitary Sewer Manhole Extra Shallow” will be made at the amount bid per each, which payment will be complete compensation for all labor, materials, equipment required to complete the work specified in the Contract Documents, and shall include but not be limited to the following:

- Locating all existing utilities and potholing in advance to determine their horizontal and vertical location, including potholing in advance for existing side sewers and television inspection of existing sanitary sewer to determine location of side sewer branches if necessary.
- Saw cutting up to 12” in depth, trench excavation, and dewatering (if needed),
- Bypass sewer pumping (if needed),
- Removal, hauling and disposal of waste materials including but not limited to pavement, curbs, gutters, sidewalks, surplus and unsuitable excavated material, existing pipes and structures in the excavation,
- Furnishing, install precast or poured-in-place concrete base, concrete manhole sections, gaskets, Kor-N-Seal boots (or approved equal), ladder and rungs, appurtenances, connections, channeling, reconnection to existing sewer pipes including pipe and couplings, coating system (sealer), manhole frame and lid,
- Furnishing and installing material to adjustment of frames to grade including HMA,
- Furnishing foundation and bedding materials, placing and compacting foundation and bedding,
- Placing and compacting backfill,
- Replacing, protecting and/or maintaining existing utilities,
- Furnishing and Placing Temporary Pavement Patching.

1-09.14(2)BH Furnish and Install 54-inch Shallow Sanitary Sewer Manhole (Bid Item B-21) — Each

Section 1-09.14(2)BH is a new section:

(*****)

Measurement for “Furnish and Install 54-inch Diameter Shallow Sanitary Sewer Manhole” will be per each for each type manhole installed in conformance with the Contract Documents.

Payment for “Furnish And Install 54-Inch Diameter Shallow Sanitary Sewer Manhole” will be made at the amount bid per each, which payment will be complete compensation for all labor, materials, equipment required to complete the work specified in the Contract Documents, and shall include but not be limited to the following:

- Locating all existing utilities and potholing in advance to determine their horizontal and vertical location, including potholing in advance for existing side sewers and television inspection of existing sanitary sewer to determine location of side sewer branches if necessary.
- Saw cutting up to 12” in depth, trench excavation, and dewatering (if needed),
- Bypass sewer pumping (if needed),

- Removal, hauling and disposal of waste materials including but not limited to pavement, curbs, gutters, sidewalks, surplus and unsuitable excavated material, existing pipes and structures in the excavation,
- Furnishing, install precast or poured-in-place concrete base, concrete manhole sections, gaskets, Kor-N-Seal boots (or approved equal), ladder and rungs, appurtenances, connections, channeling, reconnection to existing sewer pipes including pipe and couplings, coating system (sealer), manhole frame and lid,
- Furnishing and installing material to adjustment of frames to grade including HMA,
- Furnishing foundation and bedding materials, placing and compacting foundation and bedding,
- Placing and compacting backfill,
- Replacing, protecting and/or maintaining existing utilities,
- Furnishing and Placing Temporary Pavement Patching.

1-09.14(2)BI Furnish and Install 54-inch Sanitary Sewer Manhole (Bid Item B-22) — Each

Section 1-09.14(2)BI is a new section:

(*****)

Measurement for “Furnish and Install 54-inch Diameter Sanitary Sewer Manhole” will be per each for each type manhole installed in conformance with the Contract Documents.

Payment for “Furnish And Install 54-Inch Diameter Sanitary Sewer Manhole” will be made at the amount bid per each, which payment will be complete compensation for all labor, materials, equipment required to complete the work specified in the Contract Documents, and shall include but not be limited to the following:

- Locating all existing utilities and potholing in advance to determine their horizontal and vertical location, including potholing in advance for existing side sewers and television inspection of existing sanitary sewer to determine location of side sewer branches if necessary.
- Saw cutting up to 12” in depth, trench excavation, and dewatering (if needed),
- Bypass sewer pumping (if needed),
- Removal, hauling and disposal of waste materials including but not limited to pavement, curbs, gutters, sidewalks, surplus and unsuitable excavated material, existing pipes and structures in the excavation,
- Furnishing, install precast or poured-in-place concrete base, concrete manhole sections, gaskets, Kor-N-Seal boots (or approved equal), ladder and rungs, appurtenances, connections, channeling, reconnection to existing sewer pipes including pipe and couplings, coating system (sealer), manhole frame and lid,
- Furnishing and installing material to adjustment of frames to grade including HMA,
- Furnishing foundation and bedding materials, placing and compacting foundation and bedding,
- Placing and compacting backfill,
- Replacing, protecting and/or maintaining existing utilities,
- Furnishing and Placing Temporary Pavement Patching.

1-09.14(2)BJ Furnish and Install 60-inch Sanitary Sewer Manhole with Inside Drop (Bid Item B 23) – Each

Section 1-09.14(2)BJ is a new section:

(*****)

Measurement for “Furnish and Install 60-inch Diameter Sanitary Sewer Manhole with Inside Drop” will be per each for each type manhole installed in conformance with the Contract Documents.

Payment for “Furnish and Install 60-inch Diameter Sanitary Sewer Manhole with Inside Drop” will be made at the amount bid per each, which payment will be complete compensation for all labor, materials, equipment required to complete the work specified in the Contract Documents, and shall include but not be limited to the following:

- Locating all existing utilities and potholing in advance to determine their horizontal and vertical location, including potholing in advance for existing side sewers and television inspection of existing sanitary sewer to determine location of side sewer branches if necessary.
- Saw cutting up to 12” in depth, trench excavation, and dewatering (if needed),
- Bypass sewer pumping (if needed),
- Removal, hauling and disposal of waste materials including but not limited to pavement, curbs, gutters, sidewalks, surplus and unsuitable excavated material, existing pipes and structures in the excavation,
- Furnishing, install precast or poured-in-place concrete base, concrete manhole sections, gaskets, Kor-N-Seal boots (or approved equal), ladder and rungs, appurtenances, connections, channeling, reconnection to existing sewer pipes including pipe, couplings and bends, coating system (sealer), manhole frame and lid,
- Furnishing and installing clamping brackets, inside-drop pipe, laying and joining new sewer pipe to the inside-drop, bends,
- Furnishing and installing material to adjustment of frames to grade including HMA,
- Furnishing foundation and bedding materials, placing and compacting foundation and bedding,
- Placing and compacting backfill,
- Replacing, protecting and/or maintaining existing utilities,
- Furnishing and Placing Temporary Pavement Patching.

1-09.14(2)BK Furnish and Install 8-inch Sewer Cleanout (Bid Item B-24) — Each

Section 1-09.14(2)BK is a new section:

(*****)

Measurement for “Furnish and Install 8-Inch Sewer Cleanout” will be per each for the installation of C.O. installed in conformance with the Contract Documents.

Payment for “Furnish and Install 8-Inch Sewer Cleanout” will be made at the amount bid per each, which payment will be complete compensation for all labor, materials, equipment required to complete the work specified in the Contract Documents, and shall include but not be limited to the following:

- Locating all existing utilities and potholing in advance to determine their horizontal and vertical location, including potholing in advance for existing side sewers and television inspection of existing sanitary sewer to determine location of side sewer branches if necessary.

- Saw cutting up to 12" in depth, trench excavation, and dewatering (if needed),
- Bypass sewer pumping (if needed),
- Removal, hauling and disposal of waste materials including but not limited to pavement, curbs, gutters, sidewalks, surplus and unsuitable excavated material, existing pipes and structures in the excavation,
- Furnishing, installing, laying and joining sewer pipes, fittings and couplings of the size and type shown, and all incidentals,
- Furnishing and installing cleanout frame and cover,
- Furnishing and installing concrete around cleanout frame (as required by the project plans),
- Furnishing and installing material to adjustment of frames to grade,
- Furnishing foundation and bedding materials, placing and compacting foundation and bedding,
- Placing and compacting backfill,
- Replacing, protecting and/or maintaining existing utilities,
- Furnishing and Placing Temporary Pavement Patching.

1-09.14(2)BL Furnish and Install 6-inch Sewer and Cleanout in Easement (Bid Item B-25) — Lump Sum

Section 1-09.14(2)BL is a new section:

(*****)

Measurement for "Furnish and Install 6-Inch Sewer and Cleanout in Easement" will be per each for the installation of 6-Inch sewer and cleanout installed in conformance with the Contract Documents.

Payment for furnish and install 6-inch sewer and cleanout in easement will be made at the amount bid per each, which payment will be complete compensation for all labor, materials, equipment required to complete the work specified in the Contract Documents, and shall include but not be limited to the following:

- Locating all existing utilities and potholing in advance to determine their horizontal and vertical location, including potholing in advance for existing side sewers and television inspection of existing sanitary sewer to determine location of side sewer branches if necessary.
- Trench excavation, and dewatering (if needed),
- Bypass sewer pumping (if needed),
- Removal, hauling and disposal of waste materials including but not limited to pavement, curbs, gutters, sidewalks, surplus and unsuitable excavated material, existing pipes and structures in the excavation,
- Furnishing, installing, laying and joining sewer pipes, fittings and couplings of the size and type shown (approximately 15 linear feet of 6" PVC and three 6"x6" tees), and all incidentals,
- Furnishing and installing cleanout frame and cover,
- Furnishing and installing concrete around cleanout frame (as required by the project plans),
- Furnishing bedding materials, placing and compacting pipe bedding, as shown on the plans,
- Placing and compacting trench backfill,
- Landscape restoration.

1-09.14(2)BM Connect New Sewer to Existing Sewer Manhole (Bid Item B-26) — Each

Section 1-09.14(2)BM is a new section:

(*****)

Measurement for “Connect New Sewer to Existing Sewer Manhole” will be per each in conformance with the Contract Documents.

Payment for Connect New Sewer to Existing Sewer Manhole will be made at the amount bid per each, which payment will be complete compensation for all labor, materials, equipment required to complete the work specified in the Contract Documents, and shall include but not be limited to the following:

- Locating all existing utilities and potholing in advance to determine their horizontal and vertical location, including potholing in advance for existing side sewers and television inspection of existing sanitary sewer to determine location of side sewer branches if necessary.
- Trench excavation, and dewatering (if needed),
- Bypass sewer pumping (if needed),
- Removal, hauling and disposal of waste materials including but not limited to pavement, curbs, gutters, sidewalks, surplus and unsuitable excavated material, existing pipes and structures in the excavation,
- Core-drilling of existing manhole,
- Furnish and install new Kor-N-Seal boot, sand collar (or approved equal) and grouting,
- Connection of new sewer to existing manhole,
- Furnishing bedding materials, placing and compacting pipe bedding, as shown on the plans,
- Placing and compacting trench backfill,
- Furnishing and Placing Temporary Pavement Patching.

1-09.14(2)BN Pre-installation Cleaning and Inspection for CIPP in Easement (Bid Item B-27) – Linear Foot

Section 1-09.14(2)BN is a new section:

(*****)

Measurement for “Pre-Installation Cleaning and Inspection for CIPP in Easement” will be based on the linear feet of pipe inspected and each in conformance with the Contract Documents.

Payment for Pre-Installation Cleaning and Inspection for CIPP in Easement will be made at the amount bid per linear foot, which payment will be complete compensation for all labor, materials, equipment required to complete the work specified in the Contract Documents, and shall include but not be limited to the following:

- bypass sewer routing if necessary.
- cleaning,
- root cutting and removal of obstructions,
- removal and disposal of waste material,
- water,
- CCTV inspection in a PACP compatible format and provision of the CCTV record on an external HDD to the Engineer,

1-09.14(2)BO Furnish and Install 6-inch Cured-in-place Pipe in Easement (Bid Item B-28) — Linear Foot

Section 1-09.14(2)BO is a new section:

(*****)

Measurement for “Furnish and Install 6-Inch Cured-In-Place Pipe in Easement” will be based on the linear feet of 6-Inch cured-in-place pipe installed. The length will be the number of linear feet of completed installation measured along the invert and will include the length through elbows, tees and fittings. The number of linear feet will be measured from the center of manhole to center of manhole, center of cleanout or the actual end of the cured-in-place pipe if it does not end in a structure.

Payment for “Furnish and Install 6-Inch Cured-In-Place Pipe in Easement” will be made at the amount bid per linear foot, which payment will be complete compensation for all labor, materials, equipment required to complete the work specified in the Contract Documents, and shall include but not be limited to the following:

- bypass sewer routing if necessary,
- dewatering,
- cleaning,
- root cutting and removal of obstructions,
- furnishing and installing 6” diameter CIPP,
- removal and disposal of waste material,
- water

The following subsection provides the measurement and payment information of the Bid Items specific to Schedule C – Water.

1-09.14(2)CA Furnish and Install 8”, 6”, and 4” CI 52 DI Water Pipe & Fittings w/ Polywrap (Bid Item C-15, C-16, & C-17) — Linear Foot

Section 1-09.14(2)CA is a new section:

(*****)

Measurement for furnishing and installing water pipes and fittings of the size, type and class specified will be based on the actual lineal footage measured horizontally over the centerline of the installed pipe.

Payment for furnishing and installing ductile iron water pipes and fittings of the size, type and class specified shall cover the complete cost of providing all labor, materials, tools, equipment required to complete the work specified in the Contract Documents, and shall include but not be limited to the following:

- Locating all existing utilities and potholing in advance to determine their horizontal and vertical location, including potholing in advance for existing side sewers and television inspection of existing sanitary sewer to determine location of side sewer branches if necessary.
- Saw cutting up to 12” in depth, trench excavation, and dewatering (if needed),
- Removal, hauling and disposal of pavement, curbs, gutters, sidewalks, surplus and unsuitable excavated material including existing pipes and structures in the excavation and the like,
- Stockpiling suitable excavated material for use as pipe bedding and trench backfill as directed by the Engineer,

- Furnishing, installing, laying and jointing water pipes and fittings of the size, type and class shown, polyethylene encasement, special fittings, horizontal and vertical bends, mechanical joint pipe restraint, vertical crosses for poly-pigging, shackle rods, temporary blow-off assemblies, and all incidentals,
- Furnishing bedding materials, placing and compacting pipe bedding, as shown on the plans,
- Placing and compacting trench backfill,
- Testing, poly-pigging, disinfecting and flushing of new valves,
- Replacing, protecting and/or maintaining existing utilities.
- Furnishing and placing temporary pavement patching

1-09.14(2)CB Cut In 6" Gate Valve Assembly (Bid Item C-18) – Each

Section 1-09.14(2)CB is a new section:

(*****)

Measurement for furnishing and installing 6" gate valve cut in will be per each, installed in conformance with the Contract Documents.

Payment for furnishing and installing 6" gate valve cut in shall cover the complete cost of providing all labor, materials, tools, equipment required to complete the work specified in the Contract Documents, and shall include but not be limited to the following:

- Locating all existing utilities and potholing in advance to determine their horizontal and vertical location,
- Saw cutting, trench excavation, and dewatering (if needed),
- Removal, hauling and disposal of pavement, curbs, gutters, sidewalks, surplus and unsuitable excavated material including existing pipes and structures in the excavation and the like,
- Stockpiling suitable excavated material for use as pipe bedding and trench backfill as directed by the Engineer,
- Furnishing all required fittings, adapters, couplings and incidentals as required for City's water department's personnel to perform the installation.
- Placing and compacting trench backfill,
- Replacing, protecting and/or maintaining existing utilities.
- Furnishing and placing temporary pavement patching

1-09.14(2)CC Furnish and Install 8", 6", & 4" Gate Valve Assembly (Bid Item C-19, C-20, & C-21) – Each

Section 1-09.14(2)CC is a new section:

(*****)

Measurement for furnishing and installing 8", 6", and 4" gate valve assemblies will be per each for each type valve installed in conformance with the Contract Documents.

Payment for furnishing and installing 8", 6", and 4" gate valve assemblies shall cover the complete cost of providing all labor, materials, tools, equipment required to complete the work specified in the Contract Documents, and shall include but not be limited to the following:

- Locating all existing utilities and potholing in advance to determine their horizontal and vertical location,
- Saw cutting, trench excavation, and dewatering (if needed),
- Removal, hauling and disposal of pavement, curbs, gutters, sidewalks, surplus and unsuitable excavated material including existing pipes and structures in the excavation and the like,

- Stockpiling suitable excavated material for use as pipe bedding and trench backfill as directed by the Engineer,
- Furnishing and installing valves, valve boxes and covers to grade, stem extensions, valve marker posts, pipe nipples, couplings, polyethylene encasement, concrete blocking, and all incidentals,
- Placing and compacting trench backfill,
- Replacing, protecting and/or maintaining existing utilities
- Furnishing and placing temporary pavement patching

1-09.14(2)CD Concrete for Thrust Blocking, Dead-Man Anchor Blocks (Bid Item C-22) – Cubic Yard

Section 1-09.14(2)CD is a new section:

(*****)

Measurement for concrete for thrust blocking, horizontal and vertical, dead-man anchor blocks will be per cubic yard for all concrete installed for thrust blocking and dead-man anchor blocks in conformance with the Contract Documents.

Payment for concrete thrust blocking and dead man anchor blocks shall cover the complete cost of providing all labor, materials, tools, equipment required to complete the work specified in the Contract Documents, and shall include but not be limited to the following:

- Locating all existing utilities and potholing in advance to determine their horizontal and vertical location,
- Saw cutting, trench excavation, shoring and dewatering (if needed),
- Removal, hauling and disposal of pavement, curbs, gutters, sidewalks, surplus and unsuitable excavated material including existing pipes and structures in the excavation and the like,
- Stockpiling suitable excavated material for use as pipe bedding and trench backfill as directed by the Engineer,
- Furnishing and placing concrete for vertical and horizontal blocks, dead-man anchor blocks, reinforcing steel, shackle rods, clamp assembly, anchor bolts, turnbuckles, concrete form work,
- Placing and compacting trench backfill,
- Replacing, protecting and/or maintaining existing utilities.
- Furnishing and placing temporary pavement patching

1-09.14(2)CE Furnish and Install Fire Hydrant Assembly (Bid Item C-23) — Each

Section 1-09.14(2)CE is a new section:

(*****)

Measurement for furnishing and installing fire hydrant assembly will be per each for each fire hydrant assembly installed in conformance with the Contract Documents.

Payment for furnishing and installing fire hydrant assembly shall cover the complete cost of providing all labor, materials, tools, equipment required to complete the work specified in the Contract Documents, and shall include but not be limited to the following:

- Locating all existing utilities and potholing in advance to determine their horizontal and vertical location,
- Saw cutting, trench excavation, and dewatering (if needed),
- Removal, hauling and disposal of pavement, curbs, gutters, sidewalks, surplus and unsuitable excavated material including existing pipes and structures in the excavation and the like,
- Removal of existing fire hydrant, if existing hydrant is being replaced,

- Stockpiling suitable excavated material for use as pipe bedding and trench backfill as directed by the Engineer,
- Furnishing and installing new fire hydrant assembly, standpipe, shoe, and 6-inch DI piping, Storz adapter,
- Furnishing and installing shut-off valve, valve box, valve extension,
- Furnishing and installing shackles, tie-rods, concrete blocking, and joint restraints, drain rocks, polyfilm,
- Adjust hydrant to finish grade and install concrete shear block,
- Placing and compacting trench backfill,
- Testing, disinfecting and flushing of new hydrants,
- Replacing, protecting and/or maintaining existing utilities
- Furnishing and placing temporary pavement patching
- Painting the hydrants

1-09.14(2)CF Furnish and Install 1" Water Service Connection (Bid Item C-24) — Each

Section 1-09.14(2)CF is a new section:

(*****)

Measurement for furnishing and installing 1" water connection will be per each for each 1" water connection installed in conformance with the Contract Documents.

Payment for furnishing and installing 1" water connection shall cover the complete cost of providing all labor, materials, tools, equipment required to complete the work specified in the Contract Documents, and shall include but not be limited to the following:

- Locating all existing utilities and potholing in advance to determine their horizontal and vertical location,
- Saw cutting, trench excavation as needed, shoring and dewatering (if needed),
- Removal, hauling and disposal of pavement, curbs, gutters, sidewalks, surplus and unsuitable excavated material including existing pipes and structures in the excavation and the like,
- Stockpiling suitable excavated material for use as pipe bedding and trench backfill as directed by the Engineer,
- Boring, hole-hogging, tunneling, mechanical or hand trenching to install new water service lines,
- Furnishing and installing new 1- inch ball valve corporation stops, tapping the main, laying and jointing the new copper water service lines and fittings, new meter setter, new meter boxes and lids,
- Testing, disinfecting and flushing the new service line,
- Connecting the customer-side private service line to the new copper tailpiece behind the new meter setter and property lines,
- Placing and compacting trench backfill,
- Replacing, protecting and/or maintaining existing utilities.
- Restoration of public and private properties
- Furnishing and placing temporary pavement patching

1-09.14(2)CG Furnish and Install Air Release and Vacuum Valve Assembly (Bid Item C-25) — Each

Section 1-09.14(2)CG is a new section:

(*****)

Measurement for air release and vacuum valve assembly will be per each unit installed for completion in conformance with the Contract Documents.

Payment for air release and vacuum valve assembly shall cover the complete cost of providing all labor, materials, tools, equipment required to complete the work specified in the Contract Documents, and shall include but not be limited to the following:

- Locating all existing utilities and potholing in advance to determine their horizontal and vertical location,
- Saw cutting, trench excavation, shoring and dewatering (if needed),
- Removal, hauling and disposal of pavement, curbs, gutters, sidewalks, surplus and unsuitable excavated material including existing pipes and structures in the excavation and the like,
- Stockpiling suitable excavated material for use as pipe bedding and trench backfill as directed by the Engineer,
- Concrete blocking, extension of the vent lines, installation of concrete and rock pads,
- Testing, flushing and cleanup, connection to mainline,
- Placing and compacting trench backfill,
- Testing, poly-pigging, disinfecting and flushing of new valves,
- Replacing, protecting and/or maintaining existing utilities.
- Furnishing and placing temporary pavement patching

1-09.14(2)CH Connection to Existing Water Main (Bid Item C-26) — Each

Section 1-09.14(2)CH is a new section:

(*****)

Measurement for connection to existing water main will be per each connection for completion in conformance with the Contract Documents.

Payment for connection to existing water main shall cover the complete cost of providing all labor, materials, tools, equipment required to complete the work specified in the Contract Documents, and shall include but not be limited to the following:

- Locating all existing utilities and potholing in advance to determine their horizontal and vertical location,
- Saw cutting, trench excavation, shoring and dewatering (if needed),
- Removal, hauling and disposal of pavement, curbs, gutters, sidewalks, surplus and unsuitable excavated material including existing pipes and structures in the excavation and the like,
- Stockpiling suitable excavated material for use as pipe bedding and trench backfill as directed by the Engineer,
- Furnishing all required pipes, fittings, adapters, couplings and incidentals as required for City's water department's personnel to perform the initial cut-in installation of valves, and fittings on the existing water main(s),
- Furnishing all required pipes, fittings, adapters, couplings and incidentals as required for City's water department's personnel to perform the second and final connection of the new water line to the existing water system and to the valves installed during the initial cut-in as described above,
- Placing and compacting trench backfill,

- Replacing, protecting and/or maintaining existing utilities
- Furnishing and placing temporary pavement patching

1-09.14(2)CI Cut, Cap, and Block Existing Water Main (Bid Item C-27) — Each

Section 1-09.14(2)CI is a new section:

(*****)

Measurement for cut, cap, and block existing water main will be per each in conformance with the Contract Documents.

Payment for cut, cap, and block water main shall cover the complete cost of providing all labor, materials, tools, equipment required to complete the work specified in the contract documents and plans, and shall include but not be limited to the following:

- Locating all existing utilities and potholing in advance to determine their horizontal and vertical location,
- Saw cutting, trench excavation, shoring and dewatering (if needed),
- Removal, hauling and disposal of pavement, curbs, gutters, sidewalks, surplus and unsuitable excavated material, excluding any asbestos cement pipe or fittings
- Stockpiling suitable excavated material for use as pipe bedding and trench backfill as directed by the Engineer,
- Furnishing all required pipes, fittings, adapters, couplings and incidentals as required for City's water department's personnel to perform the cut and cap,
- Excavating for and installing thrust block,
- Placing and compacting trench backfill,
- Replacing, protecting and/or maintaining existing utilities.
- Furnishing and placing temporary pavement patching

1-10 TEMPORARY TRAFFIC CONTROL

1-10.1 General

1-10.1(2) Description

Delete the first paragraph and replace with:

(*****)

The Contractor shall provide flaggers, signs, and other traffic control devices not otherwise specified as being furnished by the Contracting Agency. The Contractor shall erect and maintain all construction signs, warning signs, detour signs, and other traffic control devices necessary to warn and protect the public at all times from injury or damage as a result of the Contractor's operations which may occur on highways, roads, streets, sidewalks, or paths. No Work shall be done on or adjacent to any traveled way until all necessary signs and traffic control devices are in place.

Section 1-10.1(2) is supplemented with the following:

(*****)

When the bid proposal includes an item for "Traffic Control," the Work required for this item shall be all items described in Section 1-10, including, but not limited to:

1. Furnishing and maintaining barricades, flashers, construction signage, and other channelization devices, unless a pay item is in the bid proposal for any specific device and

- the Special Provisions specify furnishing, maintaining, and payment in a different manner for that device;
2. Furnishing traffic control labor, equipment, and supervisory personnel for all traffic control labor;
 3. Furnishing any necessary vehicle(s) to set up and remove traffic control devices;
 4. Furnishing labor and vehicles for patrolling and maintaining all of the construction signs and the traffic control devices, unless a pay item is in the bid proposal to specifically pay for this Work;
 5. Furnishing labor, material, and equipment necessary for cleaning up, removing, and replacing of the construction signs and the traffic control devices destroyed or damaged during the life of the project.
 6. Removing existing signs as specified or as directed by the Engineer and delivering to the City Shops, or storing and reinstalling as directed by the Engineer.
 7. Preparing a traffic control plan for the project and designating the person responsible for traffic control at the Work site. The traffic control plan shall include descriptions of the traffic control methods and devices to be used by the prime Contractor, and subcontractors, shall be submitted at or before the preconstruction conference, and shall be subject to review and approval of the Engineer.
 8. Contacting police, fire, 911, and ambulance services to notify them in advance of any Work that will affect and traveled portion of a roadway.
 9. Assuring that all traveled portions of roadways are open to traffic during peak traffic periods, 6:30 a.m. to 8:30 a.m., and 3:00 p.m. to 6:00 p.m., or as specified in the special provisions, or as directed by the Engineer.
 10. Promptly removing or covering all non-applicable signs during periods when they are not needed.

If the Engineer requires the Contractor to furnish additional channelizing devices, pieces of equipment, or services, which could not be usually anticipated by a prudent Contractor for the maintenance and protection of traffic, then a new item or items may be established to pay for such items. Further limitations for consideration of payment for these items are that they are not covered by other pay items in the bid proposal, they are not specified in the Special Provisions as incidental, and the accumulative cost for the use of each individual channelizing device, piece of equipment, or service must exceed \$200 in total cost for the duration of their need. In the event of disputes, the Engineer will determine what is usually anticipated by a prudent Contractor. The cost for these items will be by agreed price, price established by the Engineer, or by force account. Additional items required as a result of the Contractor's modification to the traffic control plan(s) appearing in the Contract shall not be covered by the provisions in this paragraph.

If the total cost of all the Work under the Contract increases or decreases by more than 25 percent, an equitable adjustment will be considered for the item "Traffic Control" to address the increase or decrease.

Traffic control and maintenance for the safety of the traveling public on this project shall be the sole responsibility of the Contractor and all methods and equipment used will be subject to the approval of the Contracting Agency.

Traffic control devices and their use shall conform to City of Renton standards and the *Manual on Uniform Traffic Control Devices (MUTCD)*.

Any days lost due to improper traffic control will be charged against the Contractor's allowable contract time, and shall not be the cause for a claim for extra days to complete the Work.

If no bid item "Traffic Control" appears in the proposal, then all Work required by these sections will be considered incidental and their cost shall be included in the other items of Work.

1-10.2(1)B Traffic Control Supervisor

Paragraphs 1 and 2 are deleted in their entirety and replaced with the following:

(*****)

A Traffic Control Supervisor (TCS) shall be on the project whenever traffic control labor is required or as authorized by the Engineer.

The TCS shall assure that all the duties of the TCS are performed during the duration of the Contract. During non-Work periods, the TCS shall be able to be on the job site within a 45-minute time period after notification by the Engineer.

1-10.2(2) Traffic Control Plans

Section 1-10.2(2) is supplemented with the following:

(*****)

1-10.3 Traffic Control Labor, Procedure, and Devices

Section 1-10.3 is supplemented with the following:

(*****)

At the end of each working day, provisions shall be made for the safe passage of traffic and pedestrians during non-working hours.

1-10.3(3) Traffic Control Devices

1-10.3(3)A Construction Signs

Section 1-10.3(3)A paragraph 3 is supplemented with the following:

(*****)

No separate pay item will be provided in the bid proposal for Class A or Class B construction signs. All costs for the Work to provide Class A or Class B construction signs shall be included in the unit contract price for the various other items of the Work in the bid proposal.

1-10.4 Measurement

Section 1-10.4 is deleted in its entirety and replaced with:

(*****)

No specific unit of measurement will apply to the lump sum item of "Traffic Control".

No adjustment in the lump sum bid amount will be made for overtime Work or for use of relief flaggers.

1-10.5 Payment

Section 1-10.5 is deleted in its entirety and replaced with:

(*****)

Payment for all labor, materials, and equipment described in Section 1-10 will be made in accordance with Section 1-04.1, for the following bid items when included in the proposal:

“Traffic Control,” Lump Sum.

1-11 RENTON SURVEYING STANDARDS

The following is a new section with new subsections:

(*****)

1-11.1(1) Responsibility for Surveys

All surveys and survey reports shall be prepared under the direct supervision of a person registered to practice land surveying under the provisions of Chapter 18.43 RCW.

All surveys and survey reports shall be prepared in accordance with the requirements established by the Board of Registration for Professional Engineers and Land Surveyors under the provisions of Chapter 18.43 RCW.

1-11.1(2) Survey Datum and Precision

The horizontal component of all surveys shall have as its coordinate base: The North American Datum of 1983/91.

All horizontal control for projects must be referenced to or in conjunction with a minimum of two of the City of Renton's Survey Control Network monuments. The source of the coordinate values used will be shown on the survey drawing per RCW 58.09.070.

The horizontal component of all surveys shall meet or exceed the closure requirements of WAC 332-130-110. The control base lines for all surveys shall meet or exceed the requirements for a Class A survey revealed in Table 2 of the Minimum Standard Detail Requirements for ALTA/ACSM Land Title Surveys jointly established and adopted by ALTA and ACSM in 1992 or comparable classification in future editions of said document. The angular and linear closure and precision ratio of traverses used for survey control shall be revealed on the face of the survey drawing, as shall the method of adjustment.

The horizontal component of the control system for surveys using global positioning system methodology shall exhibit at least 1 part in 50,000 precision in line length dependent error analysis at a 95 percent confidence level and performed pursuant to Federal Geodetic Control Subcommittee Standards for GPS control surveys as defined in Geometric Geodetic Accuracy Standards & Specifications for Using GPS Relative Positioning Techniques dated August 1, 1989, or comparable classification in future editions of said document.

The vertical component of all surveys shall be based on NAVD 1988, the North American Vertical Datum of 1988, and tied to at least one of the City of Renton Survey Control Network benchmarks. If there are two such benchmarks within 3000 feet of the project site a tie to both shall be made. The benchmark(s) used will be shown on the drawing. If a City of Renton benchmark does not exist within

3000 feet of a project, one must be set on or near the project in a permanent manner that will remain intact throughout the duration of the project. Source of elevations (benchmark) will be shown on the drawing, as well as a description of any benchmarks established.

1-11.1(3) Subdivision Information

Those surveys dependent on section subdivision shall reveal the controlling monuments used and the subdivision of the applicable quarter section.

Those surveys dependent on retracement of a plat or short plat shall reveal the controlling monuments, measurements, and methodology used in that retracement.

1-11.1(4) Field Notes

Field notes shall be kept in conventional format in a standard bound field book with waterproof pages, and/or in an electronic field book/data collector format in an unedited, original field-produced state capable of being printed. In all cases, original field notes must **be dated with the day the field work was performed** and include a sketch and with a record of control and base line traverses describing station occupations and what measurements were made at each point.

Every point located or set shall be identified by a number and a description. Point numbers shall be unique within a complete job. The preferred method of point numbering is field notebook, page and point set on that page. Example: The first point set or found on page 16 of field book 348 would be identified as Point No. 348.16.01, the second point would be 348.16.02, etc.

Upon completion of a City of Renton project, either the field notebook(s) provided by the City or the original field notebook(s) used by the Surveyor will be given to the City. For all other Work, Surveyors will provide a copy of the notes to the City upon request. In those cases where an electronic data collector is used, a hard copy print out in ASCII text format will accompany the field notes.

1-11.1(5) Corners and Monuments

Corner: A point on a land boundary, at the juncture of two or more boundary lines. A monument is usually set at such points to physically reference a corner's location on the ground.

Monument: Any physical object or structure of record, which marks or accurately references:

- A corner or other survey point established by or under the supervision of an individual per Section 1-11.1(1) and any corner or monument established by the General Land Office and its successor the Bureau of Land Management including section subdivision corners down to and including one-sixteenth corners; and
- Any permanently monumented boundary, right-of-way alignment, or horizontal and vertical control points established by any governmental agency or private surveyor including street intersections but excluding dependent interior lot corners.

1-11.1(6) Control or Base Line Survey

Control or Base Line Surveys shall be established for all construction projects that will create permanent structures such as roads, sidewalks, bridges, utility lines or appurtenances, signal or light poles, or any non-single family building. Control or Base Line Surveys shall consist of such number of permanent monuments as are required such that every structure may be observed for staking or "as-building" while occupying one such monument and sighting another such monument. A minimum of two of these permanent monuments shall be existing monuments, recognized and on record with

the City of Renton. The Control or Base Line Survey shall occupy each monument in turn, and shall satisfy all applicable requirements of Section 1-11.1 herein.

The drawing depicting the survey shall be neat, legible, and drawn to an appropriate scale. North orientation should be clearly presented and the scale shown graphically as well as noted. The drawing must be of such quality that a reduction thereof to one-half original scale remains legible.

If recording of the survey with the King County Recorder is required, it will be prepared on 18 inch by 24 inch mylar and will comply with all provisions of Chapter 58.09 RCW. A photographic mylar of the drawing will be submitted to the City of Renton and, upon their review and acceptance per the specific requirements of the project, the original will be recorded with the King County Recorder.

If recording is not required, the survey drawing shall be prepared on 22 inch by 34 inch mylar, and the original or a photographic mylar thereof will be submitted to the City of Renton.

The survey drawings shall meet or exceed the requirements of WAC 332-130-050 and shall conform to the City of Renton's Drafting Standards. American Public Works Association symbols shall be used whenever possible, and a legend shall identify all symbols used if each point marked by a symbol is not described at each use.

An electronic listing of all principal points shown on the drawing shall be submitted with each drawing. The listing should include the point number designation (corresponding with that in the field notes), a brief description of the point, and northing, easting, and elevation (if applicable) values, all in ASCII format, on IBM PC compatible media.

1-11.1(7) Precision Levels

Vertical Surveys for the establishment of benchmarks shall satisfy all applicable requirements of Sections 1-05 and 1-11.1.

Vertical surveys for the establishment of benchmarks shall meet or exceed the standards, Specifications and procedures of third order elevation accuracy established by the Federal Geodetic Control Committee.

Benchmarks must possess both permanence and vertical stability. Descriptions of benchmarks must be complete to insure both recoverability and positive identification on recovery.

1-11.1(8) Radial and Station -- Offset Topography

Topographic surveys shall satisfy all applicable requirements of Section 1-11.1 herein.

All points occupied or back sighted in developing radial topography or establishing baselines for station-offset topography shall meet the requirements of Section 1-11.1 herein.

The drawing and electronic listing requirements set forth in Section 1-11.1 herein shall be observed for all topographic surveys.

1-11.1(9) Radial Topography

Elevations for the points occupied or back sighted in a radial topographic survey shall be determined either by, 1) spirit leveling with misclosure not to exceed 0.1 feet or Federal Geodetic Control

Committee third order elevation accuracy Specifications, OR 2) trigonometric leveling with elevation differences determined in at least two directions for each point and with misclosure of the circuit not to exceed 0.1 feet.

1-11.1(10) Station--Offset Topography

Elevations of the baseline and topographic points shall be determined by spirit leveling and shall satisfy Federal Geodetic Control Committee Specifications as to the turn points and shall not exceed 0.1 foot's error as to side shots.

1-11.1(11) As-Built Survey

All improvements required to be "as-built" (post construction survey) per City of Renton Codes, TITLE 4 Building Regulations and TITLE 9 Public Ways and Property, must be located both horizontally and vertically by a Radial survey or by a Station offset survey. The "as-built" survey must be based on the same base line or control survey used for the construction staking survey for the improvements being "as-built". The "as-built" survey for all subsurface improvements should occur prior to backfilling. Close cooperation between the installing Contractor and the "as-building" surveyor is therefore required.

All "as-built" surveys shall satisfy the requirements of Section 1-11.1(1) herein, and shall be based upon control or base line surveys made in conformance with these Specifications.

The field notes for "as-built" shall meet the requirements of Section 1-11.1(4) herein, and submitted with stamped and signed "as-built" drawings which includes a statement certifying the accuracy of the "as-built".

The drawing and electronic listing requirements set forth in Section 1-11.1(6) herein shall be observed for all "as-built" surveys.

1-11.1(12) Monument Setting and Referencing

All property or lot corners, as defined in 1-11.1(5), established or reestablished on a plat or other recorded survey shall be referenced by a permanent marker at the corner point per 1-11.2(1). In situations where such markers are impractical or in danger of being destroyed, e.g., the front corners of lots, a witness marker shall be set. In most cases, this will be the extension of the lot line to a tack in lead in the curb. The relationship between the witness monuments and their respective corners shall be shown or described on the face of the plat or survey of record, e.g., "Tacks in lead on the extension of the lot side lines have been set in the curbs on the extension of said line with the curb." In all other cases the corner shall meet the requirements of Section 1-11.2(1) herein.

All non-corner monuments, as defined in 1-11.1(5), shall meet the requirements of Section 1-11.2(2) herein. If the monument falls within a paved portion of a right-of-way or other area, the monument shall be set below the ground surface and contained within a lidded case kept separate from the monument and flush with the pavement surface, per Section 1-11.2(3).

In the case of right-of-way centerline monuments all points of curvature (PC), points of tangency (PT), street intersections, center points of cul-de-sacs shall be set. If the point of intersection (PI) for the tangents of a curve fall within the paved portion of the right-of-way, a monument can be set at the PI instead of the PC and PT of the curve.

For all non-corner monuments set while under contract to the City of Renton or as part of a City of Renton approved subdivision of property, a City of Renton Monument Card (furnished by the city) identifying the monument; point of intersection (PI), point of tangency (PT), point of curvature (PC), one-sixteenth corner, Plat monument, street intersection, etc., complete with a description of the monument, a minimum of two reference points and NAD 83/91 coordinates, and NAVD 88 elevation shall be filled out and filed with the city.

1-11.2 Materials

1-11.2(1) Property/Lot Corners

Corners per 1-11.1(5) shall be marked in a permanent manner such as 1/2 inch diameter rebar 24 inches in length, durable metal plugs or caps, tack in lead, etc., and permanently marked or tagged with the surveyor's identification number. The specific nature of the marker used can be determined by the surveyor at the time of installation.

1-11.2(2) Monuments

Monuments per 1-11.1(5) shall meet the requirements as set forth in City of Renton Standard Plans page H031 and permanently marked or tagged with the surveyor's identification number.

1-11.2(3) Monument Case and Cover

Materials shall meet the requirements of Section 9-22 and City of Renton Standard Plan H031.

2-01 CLEARING, GRUBBING, AND ROADSIDE CLEANUP

2-01.1 Description

Section 2-01.1 is supplemented with the following:

(*****)

The limits of clearing and grubbing (construction limits) shall be defined as being the construction limit lines as shown in the Plans. Where, in the opinion of the Engineer, any trees abutting or adjacent to the limits of clearing and grubbing are damaged and require removal, the Contractor shall remove such trees. Any trees flagged by the Engineer to remain within the clearing and grubbing limits shall be left undamaged by the Contractor's operations. Any flagged trees, which are damaged, shall be replaced in kind at the Contractor's expense.

Existing landscaping outside the construction limits, including but not limited to, sod, rockeries, beauty bark, decorative gravel or rock, bushes, and shrubbery shall be protected from damage.

The property owners shall be responsible for removing and/or relocating irrigation equipment, trees, shrubs, curbing, ornamental plants, and any other decorative landscaping materials within the construction limits that they wish to save. **The Contractor shall give property owners 10 days' written notice prior to removing landscaping materials.** All landscaping materials that remain in the construction limits after that time period shall be removed and disposed of, by the Contractor, in accordance with Section 2-01 and the Plans.

The Contractor shall receive approval from the Engineer prior to removal.

2-01.2 Disposal of Usable Material and Debris

Section 2-01.2 is supplemented with the following:

(*****)

The Contractor shall dispose of all debris by Disposal Method No. 2 – Waste Site.

2-01.5 Payment

Section 2-01.5 is supplemented with the following:

(*****)

The lump sum price for "Clearing and Grubbing" shall be full compensation for all Work described herein and shown in the Plans, including removing trees and shrubbery where shown in the Plans and directed by the Engineer.

2-02 REMOVAL OF STRUCTURE AND OBSTRUCTIONS

2-02.3(3) Removal of Pavement, Sidewalks, Curbs, and Gutters

Section 2-02.3(3) is revised and supplemented with the following:

(*****)

Item "1" is deleted and replaced with the following:

Haul broken-up pieces to some off-project site.

The section is supplemented with the following:

In locations where pavement, sidewalk or driveway has been removed and that must remain open to traffic prior to final restoration, a temporary asphalt patch shall be installed. Temporary asphalt patches shall be in accordance with Section 5-06.

2-02.4 Measurement

Section 2-02.4 replaces the existing vacant section:

(*****)

Sawcutting existing cement and asphalt concrete pavements shall be measured by the linear foot along the sawcut, full depth. Wheel cutting of pavement will not be measured for separate payment, but shall be included in other items of Work.

2-02.5 Payment

Section 2-02.5 is supplemented with the following:

(*****)

"Saw Cutting", per lineal foot.

"Remove Sidewalk", per square yard.

"Remove Curb and Gutter", per lineal foot.

"Cold Mix", per ton

"Remove Asphalt Concrete Pavement," per square yard.

"Remove Cement Concrete pavement," per square yard.

"Remove existing _____," per _____.

All costs related to the removal and disposal of structures and obstructions including saw cutting, excavation, backfilling, and temporary asphalt shall be considered incidental to and included in other items unless designated as specific bid items in the proposal. If pavements, sidewalks, or curbs lie

within an excavation area and are not mentioned as separate pay items, their removal will be paid for as part of the quantity removed in excavation. If they are mentioned as a separate item in the proposal, they will be measured and paid for as provided under Section 2-02.5 and will not be included in the quantity calculated for excavation.

2-03 ROADWAY EXCAVATION AND EMBANKMENT

2-03.3 Construction Requirements

Section 2-03.3 is supplemented with the following:

(*****)

Roadway excavation shall include the removal of all materials excavated from within the limits shown on the Plans. Suitable excavated material shall be used for embankments, while surplus excavated material or unsuitable material shall be disposed of by the Contractor.

Earthwork quantities and changes will be computed, either manually or by means of electronic data processing equipment, by use of the average end area method. Any changes to the proposed Work as directed by the Engineer that would alter these quantities shall be calculated by the Engineer and submitted to the Contractor for his review and verification.

Any excavation or embankment beyond the limits indicated in the Plans, unless ordered by the Engineer, shall not be paid for. All Work and material required to return these areas to their original conditions, as directed by the Engineer, shall be provided by the Contractor at his sole expense.

All areas shall be excavated, filled, and/or backfilled as necessary to comply with the grades shown on the Plans. In filled and backfilled areas, fine grading shall begin during the placement and the compaction of the final layer. In cut sections, fine grading shall begin within the final six (6) inches of cut. Final grading shall produce a surface, which is smooth and even, without abrupt changes in grade.

Excavation for curbs and gutters shall be accomplished by cutting accurately to the cross sections, grades and elevations shown. Care shall be taken not to excavate below the specified grades. The Contractor shall maintain all excavations free from detrimental quantities of leaves, brush, sticks, trash, and other debris until final acceptance of the Work.

Following removal of topsoil or excavation to grade, and before placement of fills or base course, the subgrade under the roadway shall be proof-rolled to identify any soft or loose areas which may warrant additional compaction or excavation and replacement.

The Contractor shall provide temporary drainage or protection to keep the subgrade free from standing water.

Acceptable excavated native soils shall be used for fill in the area requiring fills. Care shall be taken to place excavated material at the optimum moisture content to achieve the specified compaction. Any native material used for fill shall be free of organics and debris, and have a maximum particle size of 6 inches.

It shall be the responsibility of the Contractor to prevent the native materials from becoming saturated with water. The measures may include sloping to drain, compacting the native materials, and diverting runoff away from the materials. If the Contractor fails to take such preventative measures, any costs or delay related to drying the materials shall be at his own expense.

If the native materials become saturated, it shall be the responsibility of the Contractor to dry the materials, to the optimum moisture content. If sufficient acceptable native soils are not available to complete construction of the roadway embankment, Gravel Borrow shall be used.

If subgrade trimmer is not required on the project, all portions of Section 2-03 shall apply as though a subgrade trimmer were specified.

If sufficient acceptable native soils, as determined by the Engineer, are not available to complete construction of the roadway embankment, Gravel Borrow meeting the requirements of Section 9-03.14 of the Standard Specifications, shall be used.

2-03.4 Measurement

Section 2-03.4 is supplemented with the following:

(*****)

At the discretion of the Engineer, roadway excavation, borrow excavation, and unsuitable foundation excavation - by the cubic yard (adjusted for swell) may be measured by truck in the hauling vehicle at the point of loading. The Contractor shall provide truck tickets for each load removed. Each ticket shall have the truck number, time and date, and be approved by the Engineer.

2-03.5 Payment

Section 2-03.5 is revised with the following:

(*****)

Payment for embankment compaction will not be made as a separate item. All costs for embankment compaction shall be included in other bid items involved. Payment will be made for the following bid items when they are included in the proposal:

“Roadway Excavation Including Haul,” per cubic yard

“Removal and Replacement of Unsuitable Foundation Material,” per ton

“Gravel Borrow Including Haul,” per ton

“Roadway Excavation Including Haul” shall be considered incidental and part of the bid item(s) provided for the installation of the utility mains and appurtenances. When the Engineer orders excavation below subgrade, then payment will be in accordance with the item “Removal and Replacement of Unsuitable Foundation Material”. In this case, all items of Work other than roadway excavation shall be paid at unit contract prices.

The unit contract price per cubic yard for “Roadway Excavation Including Haul” shall be full pay for excavating, loading, placing, or otherwise disposing of the material.

The unit contract price per ton for “Removal and Replacement of Unsuitable Foundation Material” shall be full pay for excavating, loading, and disposing of the material.

Payment for embankment compaction will not be made as a separate item. All costs for embankment compaction shall be included in other bid items involved.

2-04 HAUL

2-04.5 Payment

Delete Section 2-04.5 and replace with the following:

(*****)

All costs for the hauling of material to, from, or on the job site shall be considered incidental to and included in the unit price of other units of Work.

2-06 SUBGRADE PREPARATION

2-06.5 Measurement and Payment

Section 2-06.5 is supplemented with the following:

(*****)

Subgrade preparation and maintenance including watering shall be considered as incidental to the construction and all costs thereof shall be included in the appropriate unit or lump sum contract bid prices.

2-09 STRUCTURE EXCAVATION

2-09.1 Description

Section 2-09.1 is supplemented with the following:

(*****)

This Work also includes the excavation, haul, and disposal of all unsuitable materials such as peat, muck, swampy or unsuitable materials, including buried logs and stumps.

2-09.3(1)D Disposal of Excavated Material

Section 2-09.3(1)D is revised with the following:

(*****)

The second paragraph is deleted and replaced with:

All costs for disposing of excavated material within or external to the project limits shall be included in the unit contract price for structure excavation, Class A or B.

The third paragraph is deleted and replaced with:

If the Contract includes structure excavation, Class A or B, including haul, the unit contract price shall include all costs for loading and hauling the material the full required distance, otherwise all such disposal costs shall be considered incidental to the Work.

2-09.4 Measurement

The ninth paragraph of Section 2-09.4 is deleted and replaced with the following:

(*****)

Gravel backfill. Gravel backfill, except when used as bedding for culvert, storm sewer, sanitary sewer, manholes, and catch basins, will be measured by the cubic yard in place determined by the neat lines required by the Plans or by the ton as measured in conformance with Section 1-09.2.

2-09.5 Payment

Section 2-09.5 is revised and supplemented with the following:

(*****)

Payment will be made for the following bid items when they are included in the proposal:

“Structure Excavation Class A”, per cubic yard.

“Structure Excavation Class B”, per cubic yard.

“Structure Excavation Class A Incl. Haul”, per cubic yard.

“Structure Excavation Class B Incl. Haul”, per cubic yard.

Payment for reconstruction of surfacing and paving, within the limits of structure excavation, will be at the applicable unit prices for the items involved.

If the Engineer orders the Contractor to excavate below the elevations shown in the Plans, the unit contract price per cubic yard for “Structure Excavation Class A or B” will apply. But if the Contractor excavates deeper than the Plans or the Engineer requires, the Contracting Agency will not pay for material removed from below the required elevations. In this case, the Contractor, at no expense to the Contracting Agency, shall replace such material with concrete or other material the Engineer approves. The unit contract price per cubic yard for the bid items listed as 1 through 4 above shall be full pay for all labor, materials, tools, equipment, and pumping, or shall be included in the unit bid price of other items of Work if "Structure Excavation" or "Structure Excavation Incl Haul" are not listed as pay items in the Contract.

“Shoring or Extra Excavation Class B”, per square foot.

The unit contract price per square foot shall be full pay for all excavation, backfill, compaction, and other Work required when extra excavation is used in lieu of constructing shoring. If select backfill material is required for backfilling within the limits of the structure excavation, it shall also be required as backfill material for the extra excavation at the Contractor’s expense. Any excavation or backfill material being paid by unit price shall be calculated by the Engineer only for the neat line measurement of the excavation and shall not include the extra excavation beyond the neat line.

If there is no bid item for shoring or extra excavation Class B on a square foot basis and the nature of the excavation is such that shoring or extra excavation is required as determined by the Engineer, then shoring or extra excavation shall be considered incidental to the Work involved and no further compensation shall be made.

“Gravel Backfill (Kind) for (Type of Excavation)”, per cubic yard or per ton.

When gravel backfill is paid by the ton, the Contractor shall take care to assure to the satisfaction of the Engineer that such per ton backfill is only being used for the specified purpose and not for purposes where backfill is incidental or being paid by cubic yard. Evidence that per ton gravel backfill is not being used for its designated purpose shall be grounds for the Engineer to deny payment for such load tickets.

“Controlled Density Fill”, per cubic yard.

5-04 HOT MIX ASPHALT

(March 5, 2018 APWA GSP)

Delete this Section in its entirety and replace it with the following:

(*****)

5-04.1 Description

This Work shall consist of providing and placing one or more layers of plant-mixed hot mix asphalt (HMA) on a prepared foundation or base in accordance with these Specifications. The Contractor shall maintain the existing street surface contours (e.g. street profile and cross section, etc.), unless otherwise directed by the Engineer. The manufacture of HMA may include warm mix asphalt (WMA) processes in accordance with these Specifications. WMA processes include organic additives, chemical additives, and foaming.

HMA shall be composed of asphalt binder and mineral materials as may be required, mixed in the proportions specified to provide a homogeneous, stable, and workable mixture.

See Appendix A for the Summary of Quantities that lists the streets to receive an overlay, the paving limits and the thickness of HMA. All HMA to be placed in this contract shall be HMA CL. ½" PG 64-22.

5-04.2 Materials

Materials shall meet the requirements of the following sections:

Asphalt Binder	9-02.1(4)
Cationic Emulsified Asphalt	9-02.1(6)
Anti-Stripping Additive	9-02.4
HMA Additive	9-02.5
Aggregates	9-03.8
Recycled Asphalt Pavement	9-03.8(3)B
Mineral Filler	9-03.8(5)
Recycled Material	9-03.21
Portland Cement	9-01
Sand	9-03.1(2)
(As noted in 5-04.3(5)C for crack sealing)	
Joint Sealant	9-04.2
Foam Backer Rod	9-04.2(3)A

The Contract documents may establish that the various mineral materials required for the manufacture of HMA will be furnished in whole or in part by the Contracting Agency. If the documents do not establish the furnishing of any of these mineral materials by the Contracting Agency, the Contractor shall be required to furnish such materials in the amounts required for the designated mix. Mineral materials include coarse and fine aggregates, and mineral filler.

The Contractor may choose to utilize recycled asphalt pavement (RAP) in the production of HMA. The RAP may be from pavements removed under the Contract, if any, or pavement material from an existing stockpile.

The Contractor may use up to 20 percent RAP by total weight of HMA with no additional sampling or testing of the RAP. The RAP shall be sampled and tested at a frequency of one sample for every 1,000 tons produced and not less than ten samples per project. The asphalt content and gradation test data shall be reported to the Contracting Agency when submitting the mix design for approval on the QPL. The Contractor shall include the RAP as part of the mix design as defined in these Specifications.

The grade of asphalt binder shall be as required by the Contract. Blending of asphalt binder from different sources is not permitted.

The Contractor may only use warm mix asphalt (WMA) processes in the production of HMA with 20 percent or less RAP by total weight of HMA. The Contractor shall submit to the Engineer for approval the process that is proposed and how it will be used in the manufacture of HMA.

Production of aggregates shall comply with the requirements of Section 3-01.

Preparation of stockpile site, the stockpiling of aggregates, and the removal of aggregates from stockpiles shall comply with the requirements of Section 3-02.

5-04.2(1) How to Get an HMA Mix Design on the QPL

If the contractor wishes to submit a mix design for inclusion in the Qualified Products List (QPL), please follow the WSDOT process outlined as follows:

Comply with each of the following:

- Develop the mix design in accordance with WSDOT SOP 732.
- Develop a mix design that complies with Sections 9-03.8(2) and 9-03.8(6).
- Develop a mix design no more than 6 months prior to submitting it for QPL evaluation.
- Submit mix designs to the WSDOT State Materials Laboratory in Tumwater, including WSDOT Form 350-042.
- Include representative samples of the materials that are to be used in the HMA production as part of the mix design submittal.
- Identify the brand, type, and percentage of anti-stripping additive in the mix design submittal.
- Include with the mix design submittal a certification from the asphalt binder supplier that the anti-stripping additive is compatible with the crude source and the formulation of asphalt binder proposed for use in the mix design.
- Do not include warm mix asphalt (WMA) additives when developing a mix design or submitting a mix design for QPL evaluation. The use of warm mix asphalt (WMA) additives is not part of the process for obtaining approval for listing a mix design on the QPL. Refer to Section 5-04.2(2)B.

5-04.2(1)A Vacant

5-04.2(2) Mix Design – Obtaining Project Approval

No paving shall begin prior to the approval of the mix design by the Engineer.

Nonstatistical evaluation will be used for all HMA not designated as Commercial HMA in the contract documents.

Commercial evaluation will be used for Commercial HMA and for other classes of HMA in the following applications: sidewalks, road approaches, ditches, slopes, paths, trails, gores, pre-level, and pavement repair. Other nonstructural applications of HMA accepted by commercial evaluation shall be as approved by the Project Engineer. Sampling and testing of HMA accepted by commercial evaluation will be at the option of the Project Engineer. The Proposal quantity of HMA that is accepted by commercial evaluation will be excluded from the quantities used in the determination of non-statistical evaluation.

Nonstatistical Mix Design. Fifteen days prior to the first day of paving the contractor shall provide one of the following mix design verification certifications for Contracting Agency review;

- The WSDOT Mix Design Evaluation Report from the current WSDOT QPL, or one of the mix design verification certifications listed below.
- The proposed HMA mix design on WSDOT Form 350-042 with the seal and certification (stamp & signature) of a valid licensed Washington State Professional Engineer.
- The Mix Design Report for the proposed HMA mix design developed by a qualified City or County laboratory that is within one year of the approval date.**

** The mix design report shall be performed by a lab accredited by a national authority such as Laboratory Accreditation Bureau, L-A-B for Construction Materials Testing, The Construction Materials Engineering Council (CMEC's) ISO 17025 or AASHTO Accreditation Program (AAP) and shall supply evidence of participation in the AASHTO: resource proficiency sample program.

Mix designs for HMA accepted by Non-statistical evaluation shall;

- Have the aggregate structure and asphalt binder content determined in accordance with WSDOT Standard Operating Procedure 732 and meet the requirements of Sections 9-03.8(2), except that Hamburg testing for ruts and stripping are at the discretion of the Engineer, and 9-03.8(6).
- Have anti-strip requirements, if any, for the proposed mix design determined in accordance with AASHTO T 283 or T 324, or based on historic anti-strip and aggregate source compatibility from previous WSDOT lab testing.

At the discretion of the Engineer, agencies may accept verified mix designs older than 12 months from the original verification date with a certification from the Contractor that the materials and sources are the same as those shown on the original mix design.

Commercial Evaluation. Approval of a mix design for "Commercial Evaluation" will be based on a review of the Contractor's submittal of WSDOT Form 350-042 (For commercial mixes, AASHTO T 324 evaluation is not required) or a Mix Design from the current WSDOT QPL or from one of the processes allowed by this section. Testing of the HMA by the Contracting Agency for mix design approval is not required.

For the Bid Item Commercial HMA, the Contractor shall select a class of HMA and design level of Equivalent Single Axle Loads (ESAL's) appropriate for the required use.

5-04.2(2)B Using Warm Mix Asphalt Processes

The Contractor may elect to use additives that reduce the optimum mixing temperature or serve as a compaction aid for producing HMA. Additives include organic additives, chemical additives and foaming processes. The use of Additives is subject to the following:

- Do not use additives that reduce the mixing temperature more than allowed in Section 5-04.3(6) in the production of mixtures.
- Before using additives, obtain the Engineer's approval using WSDOT Form 350-076 to describe the proposed additive and process.

5-04.3 Construction Requirements**5-04.3(1) Weather Limitations**

Do not place HMA for wearing course on any Traveled Way beginning October 1st through March 31st of the following year without written concurrence from the Engineer.

Do not place HMA on any wet surface, or when the average surface temperatures are less than those specified below, or when weather conditions otherwise prevent the proper handling or finishing of the HMA.

Minimum Surface Temperature for Paving

Compacted Thickness (Feet)	Wearing Course	Other Courses
Less than 0.10	55°F	45°F
0.10 to .20	45°F	35°F
More than 0.20	35°F	35°F

5-04.3(2) Paving Under Traffic

When the Roadway being paved is open to traffic, the requirements of this Section shall apply.

The Contractor shall keep intersections open to traffic at all times except when paving the intersection or paving across the intersection. During such time, and provided that there has been an advance warning to the public, the intersection may be closed for the minimum time required to place and compact the mixture. In hot weather, the Engineer may require the application of water to the pavement to accelerate the finish rolling of the pavement and to shorten the time required before reopening to traffic.

Before closing an intersection, advance warning signs shall be placed and signs shall also be placed marking the detour or alternate route.

During paving operations, temporary pavement markings shall be maintained throughout the project. Temporary pavement markings shall be installed on the Roadway prior to opening to traffic. Temporary pavement markings shall be in accordance with Section 8-23.

All costs in connection with performing the Work in accordance with these requirements, except the cost of temporary pavement markings, shall be included in the unit Contract prices for the various Bid items involved in the Contract.

5-04.3(3) Equipment

5-04.3(3)A Mixing Plant

Plants used for the preparation of HMA shall conform to the following requirements:

1. **Equipment for Preparation of Asphalt Binder** – Tanks for the storage of asphalt binder shall be equipped to heat and hold the material at the required temperatures. The heating shall be accomplished by steam coils, electricity, or other approved means so that no flame shall be in contact with the storage tank. The circulating system for the asphalt binder shall be designed to ensure proper and continuous circulation during the operating period. A valve for the purpose of sampling the asphalt binder shall be placed in either the storage tank or in the supply line to the mixer.
2. **Thermometric Equipment** – An armored thermometer, capable of detecting temperature ranges expected in the HMA mix, shall be fixed in the asphalt binder feed line at a location near the charging valve at the mixer unit. The thermometer location shall be convenient and safe for access by Inspectors. The plant shall also be equipped with an approved dial-scale thermometer, a mercury actuated thermometer, an electric pyrometer, or another approved thermometric instrument placed at the discharge chute of the drier to automatically register or indicate the temperature of the heated aggregates. This device shall be in full view of the plant operator.
3. **Heating of Asphalt Binder** – The temperature of the asphalt binder shall not exceed the maximum recommended by the asphalt binder manufacturer nor shall it be below the minimum temperature required to maintain the asphalt binder in a homogeneous state. The asphalt binder shall be heated in a manner that will avoid local variations in heating. The heating method shall provide a continuous supply of asphalt binder to the mixer at a uniform average temperature with no individual variations exceeding 25°F. Also, when a WMA additive is included in the asphalt binder, the temperature of the asphalt binder shall not exceed the maximum recommended by the manufacturer of the WMA additive.
4. **Sampling and Testing of Mineral Materials** – The HMA plant shall be equipped with a mechanical sampler for the sampling of the mineral materials. The mechanical sampler shall meet the requirements of Section 1-05.6 for the crushing and screening operation. The Contractor shall provide for the setup and operation of the field testing facilities of the Contracting Agency as provided for in Section 3-01.2(2).
5. **Sampling HMA** – The HMA plant shall provide for sampling HMA by one of the following methods:
 - a. A mechanical sampling device attached to the HMA plant.
 - b. Platforms or devices to enable sampling from the hauling vehicle without entering the hauling vehicle.

5-04.3(3)B Hauling Equipment

Trucks used for hauling HMA shall have tight, clean, smooth metal beds and shall have a cover of canvas or other suitable material of sufficient size to protect the mixture from adverse weather. Whenever the weather conditions during the work shift include, or are forecast to include, precipitation or an air temperature less than 45°F or when time from loading to unloading exceeds 30 minutes, the cover shall be securely attached to protect the HMA.

The contractor shall provide an environmentally benign means to prevent the HMA mixture from adhering to the hauling equipment. Excess release agent shall be drained prior to filling hauling equipment with HMA. Petroleum derivatives or other coating material that contaminate or alter the

characteristics of the HMA shall not be used. For live bed trucks, the conveyer shall be in operation during the process of applying the release agent.

5-04.3(3)C Pavers

HMA pavers shall be self-contained, power-propelled units, provided with an internally heated vibratory screed and shall be capable of spreading and finishing courses of HMA plant mix material in lane widths required by the paving section ~~shown in the Plans.~~ listed in the Summary of Quantities located in Appendix A.

The HMA paver shall be in good condition and shall have the most current equipment available from the manufacturer for the prevention of segregation of the HMA mixture installed, in good condition, and in working order. The equipment certification shall list the make, model, and year of the paver and any equipment that has been retrofitted.

The screed shall be operated in accordance with the manufacturer's recommendations and shall effectively produce a finished surface of the required evenness and texture without tearing, shoving, segregating, or gouging the mixture. A copy of the manufacturer's recommendations shall be provided upon request by the Contracting Agency. Extensions will be allowed provided they produce the same results, including ride, density, and surface texture as obtained by the primary screed. Extensions without augers and an internally heated vibratory screed shall not be used in the Traveled Way.

When specified in the Contract or directed by the Engineer, reference lines for vertical control will be required. Lines shall be placed on both outer edges of the Traveled Way of each Roadway. Horizontal control utilizing the reference line will be permitted. The grade and slope for intermediate lanes shall be controlled automatically from reference lines or by means of a mat referencing device and a slope control device. When the finish of the grade prepared for paving is superior to the established tolerances and when, in the opinion of the Engineer, further improvement to the line, grade, cross-section, and smoothness can best be achieved without the use of the reference line, a mat referencing device may be substituted for the reference line. Substitution of the device will be subject to the continued approval of the Engineer. A joint matcher may be used subject to the approval of the Engineer. The reference line may be removed after the completion of the first course of HMA when approved by the Engineer. Whenever the Engineer determines that any of these methods are failing to provide the necessary vertical control, the reference lines will be reinstalled by the Contractor.

The Contractor shall furnish and install all pins, brackets, tensioning devices, wire, and accessories necessary for satisfactory operation of the automatic control equipment.

If the paving machine in use is not providing the required finish, the Engineer may suspend Work as allowed by Section 1-08.6. Any cleaning or solvent type liquids spilled on the pavement shall be thoroughly removed before paving proceeds.

5-04.3(3)D Material Transfer Device or Material Transfer Vehicle

A Material Transfer Device/Vehicle (MTD/V) shall only be used with the Engineer's approval, unless otherwise required by the contract. A MTD/V is not required for this contract.

Where an MTD/V is required by the contract, the Engineer may approve paving without an MTD/V, at the request of the Contractor. The Engineer will determine if an equitable adjustment in cost or time is due.

When used, the MTD/V shall mix the HMA after delivery by the hauling equipment and prior to laydown by the paving machine. Mixing of the HMA shall be sufficient to obtain a uniform temperature throughout the mixture. If a windrow elevator is used, the length of the windrow may be limited in urban areas or through intersections, at the discretion of the Engineer.

To be approved for use, an MTV:

1. Shall be self-propelled vehicle, separate from the hauling vehicle or paver.
2. Shall not be connected to the hauling vehicle or paver.
3. May accept HMA directly from the haul vehicle or pick up HMA from a windrow.
4. Shall mix the HMA after delivery by the hauling equipment and prior to placement into the paving machine.
5. Shall mix the HMA sufficiently to obtain a uniform temperature throughout the mixture.

To be approved for use, an MTD:

1. Shall be positively connected to the paver.
2. May accept HMA directly from the haul vehicle or pick up HMA from a windrow.
3. Shall mix the HMA after delivery by the hauling equipment and prior to placement into the paving machine.
4. Shall mix the HMA sufficiently to obtain a uniform temperature throughout the mixture.

5-04.3(3)E Rollers

Rollers shall be of the steel wheel, vibratory, oscillatory, or pneumatic tire type, in good condition and capable of reversing without backlash. Operation of the roller shall be in accordance with the manufacturer's recommendations. When ordered by the Engineer for any roller planned for use on the project, the Contractor shall provide a copy of the manufacturer's recommendation for the use of that roller for compaction of HMA. The number and weight of rollers shall be sufficient to compact the mixture in compliance with the requirements of Section 5-04.3(1). The use of equipment that results in crushing of the aggregate will not be permitted. Rollers producing pickup, washboard, uneven compaction of the surface, displacement of the mixture or other undesirable results shall not be used.

5-04.3(4) Preparation of Existing Paved Surfaces

When the surface of the existing pavement or old base is irregular, the Contractor shall bring it to a uniform grade and cross-section as ~~shown on the Plans~~ or approved by the Engineer.

Preleveling of uneven or broken surfaces over which HMA is to be placed may be accomplished by using an asphalt paver, a motor patrol grader, or by hand raking, as approved by the Engineer.

Compaction of preleveling HMA shall be to the satisfaction of the Engineer and may require the use of small steel wheel rollers, plate compactors, or pneumatic rollers to avoid bridging across preleveled areas by the compaction equipment. Equipment used for the compaction of preleveling HMA shall be approved by the Engineer.

Before construction of HMA on an existing paved surface, the entire surface of the pavement shall be clean. All fatty asphalt patches, grease drippings, and other objectionable matter shall be entirely removed from the existing pavement. All pavements or bituminous surfaces shall be thoroughly cleaned of dust, soil, pavement grindings, and other foreign matter. All holes and small depressions shall be filled with an appropriate class of HMA. The surface of the patched area shall be leveled and compacted thoroughly. Prior to the application of tack coat, or paving, the condition of the surface shall be approved by the Engineer.

A tack coat of asphalt shall be applied to all paved surfaces on which any course of HMA is to be placed or abutted; except that tack coat may be omitted from clean, newly paved surfaces at the discretion of the Engineer. Tack coat shall be uniformly applied to cover the existing pavement with a thin film of residual asphalt free of streaks and bare spots at a rate between 0.02 and 0.10 gallons per square yard of retained asphalt. The rate of application shall be approved by the Engineer. A heavy application of tack coat shall be applied to all joints. For Roadways open to traffic, the application of tack coat shall be limited to surfaces that will be paved during the same working shift. The spreading equipment shall be equipped with a thermometer to indicate the temperature of the tack coat material.

Equipment shall not operate on tacked surfaces until the tack has broken and cured. If the Contractor's operation damages the tack coat it shall be repaired prior to placement of the HMA.

The tack coat shall be CSS-1, or CSS-1h emulsified asphalt. The CSS-1 and CSS-1h emulsified asphalt may be diluted once with water at a rate not to exceed one part water to one part emulsified asphalt. The tack coat shall have sufficient temperature such that it may be applied uniformly at the specified rate of application and shall not exceed the maximum temperature recommended by the emulsified asphalt manufacturer.

All utility appurtenances (e.g. manhole covers, valve covers, etc.) located within the paving limits shall be coated with a biodegradable soap to prevent the tack coat and HMA from sticking to them. Diesel shall not be used for this purpose. After application of the biodegradable soap, all catch basins shall be covered to prevent tack and HMA from entering into them.

5-04.3(4)A Crack Sealing

5-04.3(4)A1 General

When the Proposal includes a pay item for crack sealing, seal all cracks $\frac{1}{4}$ inch in width and greater.

Cleaning: Ensure that cracks are thoroughly clean, dry and free of all loose and foreign material when filling with crack sealant material. Use a hot compressed air lance to dry and warm the pavement surfaces within the crack immediately prior to filling a crack with the sealant material. Do not overheat pavement. Do not use direct flame dryers. Routing cracks is not required.

Sand Slurry: For cracks that are to be filled with sand slurry, thoroughly mix the components and pour the mixture into the cracks until full. Add additional CSS-1 cationic emulsified asphalt to the sand slurry as needed for workability to ensure the mixture will completely fill the cracks. Strike off the sand slurry flush with the existing pavement surface and allow the mixture to cure. Top off cracks that were not completely filled with additional sand slurry. Do not place the HMA overlay until the slurry has fully cured.

The sand slurry shall consist of approximately 20 percent CSS-1 emulsified asphalt, approximately 2 percent portland cement, water (if required), and the remainder clean Class 1 or 2 fine aggregate per section 9-03.1(2). The components shall be thoroughly mixed and then poured into the cracks and joints until full. The following day, any cracks or joints that are not completely filled shall be topped off with additional sand slurry. After the sand slurry is placed, the filler shall be struck off flush with the existing pavement surface and allowed to cure. The HMA overlay shall not be placed until the slurry has fully cured. The requirements of Section 1-06 will not apply to the portland cement and sand used in the sand slurry.

In areas where HMA will be placed, use sand slurry to fill the cracks.

In areas where HMA will not be placed, fill the cracks as follows:

1. Cracks ¼ inch to 1 inch in width - fill with hot poured sealant.
2. Cracks greater than 1 inch in width – fill with sand slurry.

Hot Poured Sealant: For cracks that are to be filled with hot poured sealant, apply the material in accordance with these requirements and the manufacturer’s recommendations. Furnish a Type 1 Working Drawing of the manufacturer’s product information and recommendations to the Engineer prior to the start of work, including the manufacturer’s recommended heating time and temperatures, allowable storage time and temperatures after initial heating, allowable reheating criteria, and application temperature range. Confine hot poured sealant material within the crack. Clean any overflow of sealant from the pavement surface. If, in the opinion of the Engineer, the Contractor’s method of sealing the cracks with hot poured sealant results in an excessive amount of material on the pavement surface, stop and correct the operation to eliminate the excess material.

5-04.3(4)A2 Crack Sealing Areas Prior to Paving

In areas where HMA will be placed, use sand slurry to fill the cracks.

5-04.3(4)A3 Crack Sealing Areas Not to be Paved

In areas where HMA will not be placed, fill the cracks as follows:

- a. Cracks ¼ inch to 1 inch in width - fill with hot poured sealant.
- b. Cracks greater than 1 inch in width – fill with sand slurry.

5-04.3(4)B Vacant

5-04.3(4)C Pavement Repair

The Contractor shall excavate pavement repair areas and shall backfill these with HMA in accordance with the details shown in the Plans and as marked in the field. The Contractor shall conduct the excavation operations in a manner that will protect the pavement that is to remain. Pavement not designated to be removed that is damaged as a result of the Contractor’s operations shall be repaired by the Contractor to the satisfaction of the Engineer at no cost to the Contracting Agency. The Contractor shall excavate only within one lane at a time unless approved otherwise by the Engineer. The Contractor shall not excavate more area than can be completely finished during the same shift, unless approved by the Engineer.

Unless otherwise shown in the Plans or determined by the Engineer, excavate to a depth of 1.0 feet. The Engineer will make the final determination of the excavation depth required. The minimum width

of any pavement repair area shall be 40 inches unless shown otherwise in the Plans. Before any excavation, the existing pavement shall be sawcut or shall be removed by a pavement grinder. Excavated materials will become the property of the Contractor and shall be disposed of in a Contractor-provided site off the Right of Way or used in accordance with Sections 2-02.3(3) or 9-03.21.

Asphalt for tack coat shall be required as specified in Section 5-04.3(4). A heavy application of tack coat shall be applied to all surfaces of existing pavement in the pavement repair area.

Placement of the HMA backfill shall be accomplished in lifts not to exceed 0.35-foot compacted depth. Lifts that exceed 0.35-foot of compacted depth may be accomplished with the approval of the Engineer. Each lift shall be thoroughly compacted by a mechanical tamper or a roller.

5-04.3(5) Producing/Stockpiling Aggregates and RAP

Aggregates and RAP shall be stockpiled according to the requirements of Section 3-02. Sufficient storage space shall be provided for each size of aggregate and RAP. Materials shall be removed from stockpile(s) in a manner to ensure minimal segregation when being moved to the HMA plant for processing into the final mixture. Different aggregate sizes shall be kept separated until they have been delivered to the HMA plant.

5-04.3(5)A Vacant

5-04.3(6) Mixing

After the required amount of mineral materials, asphalt binder, recycling agent and anti-stripping additives have been introduced into the mixer the HMA shall be mixed until complete and uniform coating of the particles and thorough distribution of the asphalt binder throughout the mineral materials is ensured.

When discharged, the temperature of the HMA shall not exceed the optimum mixing temperature by more than 25°F as shown on the reference mix design report or as approved by the Engineer. Also, when a WMA additive is included in the manufacture of HMA, the discharge temperature of the HMA shall not exceed the maximum recommended by the manufacturer of the WMA additive. A maximum water content of 2 percent in the mix, at discharge, will be allowed providing the water causes no problems with handling, stripping, or flushing. If the water in the HMA causes any of these problems, the moisture content shall be reduced as directed by the Engineer.

Storing or holding of the HMA in approved storage facilities will be permitted with approval of the Engineer, but in no event shall the HMA be held for more than 24 hours. HMA held for more than 24 hours after mixing shall be rejected. Rejected HMA shall be disposed of by the Contractor at no expense to the Contracting Agency. The storage facility shall have an accessible device located at the top of the cone or about the third point. The device shall indicate the amount of material in storage. No HMA shall be accepted from the storage facility when the HMA in storage is below the top of the cone of the storage facility, except as the storage facility is being emptied at the end of the working shift.

Recycled asphalt pavement (RAP) utilized in the production of HMA shall be sized prior to entering the mixer so that a uniform and thoroughly mixed HMA is produced. If there is evidence of the

recycled asphalt pavement not breaking down during the heating and mixing of the HMA, the Contractor shall immediately suspend the use of the RAP until changes have been approved by the Engineer. After the required amount of mineral materials, RAP, new asphalt binder and asphalt rejuvenator have been introduced into the mixer the HMA shall be mixed until complete and uniform coating of the particles and thorough distribution of the asphalt binder throughout the mineral materials, and RAP is ensured.

5-04.3(7) Spreading and Finishing

The mixture shall be laid upon an approved surface, spread, and struck off to the grade and elevation established. HMA pavers complying with Section 5-04.3(3) shall be used to distribute the mixture. Unless otherwise directed by the Engineer, the nominal compacted depth of any layer of any course shall not exceed the following:

HMA Class 1"	0.35 feet
HMA Class ¾" and HMA Class ½"	
wearing course	0.30 feet
other courses	0.35 feet
HMA Class ⅜"	0.15 feet

On areas where irregularities or unavoidable obstacles make the use of mechanical spreading and finishing equipment impractical, the paving may be done with other equipment or by hand.

When more than one JMF is being utilized to produce HMA, the material produced for each JMF shall be placed by separate spreading and compacting equipment. The intermingling of HMA produced from more than one JMF is prohibited. Each strip of HMA placed during a work shift shall conform to a single JMF established for the class of HMA specified unless there is a need to make an adjustment in the JMF.

All cast off rock from raking shall be removed prior to compaction of final HMA lift.

5-04.3(8) Aggregate Acceptance Prior to Incorporation in HMA

For HMA accepted by nonstatistical evaluation the aggregate properties of sand equivalent, uncompacted void content and fracture will be evaluated in accordance with Section 3-04. Sampling and testing of aggregates for HMA accepted by commercial evaluation will be at the option of the Engineer.

5-04.3(9) HMA Mixture Acceptance

Acceptance of HMA shall be as provided under nonstatistical, or commercial evaluation.

Nonstatistical evaluation will be used for the acceptance of HMA unless Commercial Evaluation is specified.

Commercial evaluation will be used for Commercial HMA and for other classes of HMA in the following applications: sidewalks, road approaches, ditches, slopes, paths, trails, gores, prelevel, temporary pavement, and pavement repair. Other nonstructural applications of HMA accepted by commercial evaluation shall be as approved by the Engineer. Sampling and testing of HMA accepted by commercial evaluation will be at the option of the Engineer.

The mix design will be the initial JMF for the class of HMA. The Contractor may request a change in the JMF. Any adjustments to the JMF will require the approval of the Engineer and may be made in accordance with this section.

HMA Tolerances and Adjustments

1. **Job Mix Formula Tolerances** – The constituents of the mixture at the time of acceptance shall conform to the following tolerances:

Aggregate Percent Passing	Non-Statistical Evaluation	Commercial Evaluation
1", ¾", ½", and 3/8" sieves	+/- 6%	+/- 8%
No. 4 sieve	+/- 6%	+/- 8%
No. 8 Sieve	+/- 6%	+/- 8%
No. 200 sieve	+/- 2.0%	+/- 3.0%
Asphalt Binder	+/- 0.5%	+/- 0.7%
Air Voids, Va	2.5% min. and 5.5% max	N/A

These tolerance limits constitute the allowable limits as described in Section 1-06.2. The tolerance limit for aggregate shall not exceed the limits of the control points, except the tolerance limits for sieves designated as 100 percent passing will be 99-100.

2. **Job Mix Formula Adjustments** – An adjustment to the aggregate gradation or asphalt binder content of the JMF requires approval of the Engineer. Adjustments to the JMF will only be considered if the change produces material of equal or better quality and may require the development of a new mix design if the adjustment exceeds the amounts listed below.
 - a. **Aggregates** – 2 percent for the aggregate passing the 1½", 1", ¾", ½", ⅜", and the No. 4 sieves, 1 percent for aggregate passing the No. 8 sieve, and 0.5 percent for the aggregate passing the No. 200 sieve. The adjusted JMF shall be within the range of the control points in Section 9-03.8(6).
 - b. **Asphalt Binder Content** – The Engineer may order or approve changes to asphalt binder content. The maximum adjustment from the approved mix design for the asphalt binder content shall be 0.3 percent

5-04.3(9)A Vacant

5-04.3(9)B Vacant

5-04.3(9)C Mixture Acceptance – Nonstatistical Evaluation

HMA mixture which is accepted by Nonstatistical Evaluation will be evaluated by the Contracting Agency by dividing the HMA tonnage into lots.

5-04.3(9)C1 Mixture Nonstatistical Evaluation – Lots and Sublots

A lot is represented by randomly selected samples of the same mix design that will be tested for acceptance. A lot is defined as the total quantity of material or work produced for each Job Mix Formula placed. Only one lot per JMF is expected. A subplot shall be equal to one day's production or 800 tons, whichever is less except that the final subplot will be a minimum of 400 tons and may be increased to 1200 tons.

All of the test results obtained from the acceptance samples from a given lot shall be evaluated collectively. If the Contractor requests a change to the JMF that is approved, the material produced after the change will be evaluated on the basis of the new JMF for the remaining sublots in the current lot and for acceptance of subsequent lots. For a lot in progress with a CPF less than 0.75, a new lot will begin at the Contractor’s request after the Engineer is satisfied that material conforming to the Specifications can be produced.

Sampling and testing for evaluation shall be performed on the frequency of one sample per subplot.

5-04.3(9)C2 Mixture Nonstatistical Evaluation Sampling

Samples for acceptance testing shall be obtained by the Contractor when ordered by the Engineer. The Contractor shall sample the HMA mixture in the presence of the Engineer and in accordance with AASHTO T 168. A minimum of three samples should be taken for each class of HMA placed on a project. If used in a structural application, at least one of the three samples shall be tested.

Sampling and testing HMA in a structural application where quantities are less than 400 tons is at the discretion of the Engineer.

For HMA used in a structural application with a total project quantity less than 800 tons but more than 400 tons, a minimum of one acceptance test shall be performed. In all cases, a minimum of 3 samples will be obtained at the point of acceptance, a minimum of one of the three samples will be tested for conformance to the JMF:

- If the test results are found to be within specification requirements, additional testing will be at the Engineer’s discretion.
- If test results are found not to be within specification requirements, additional testing of the remaining samples to determine a Composite Pay Factor (CPF) shall be performed.

5-04.3(9)C3 Mixture Nonstatistical Evaluation – Acceptance Testing

Testing of HMA for compliance of Va will at the option of the Contracting Agency. If tested, compliance of Va will use WSDOT SOP 731. Testing of HMA for compliance of Va will not be performed by the Contracting Agency for this contract.

Testing for compliance of asphalt binder content will be by WSDOT FOP for AASHTO T 308.

Testing for compliance of gradation will be by FOP for WAQTC T 27/T 11.

5-04.3(9)C4 Mixture Nonstatistical Evaluation – Pay Factors

For each lot of material falling outside the tolerance limits in 5-04.3(9), the Contracting Agency will determine a Composite Pay Factor (CPF) using the following price adjustment factors:

Table of Price Adjustment Factors	
Constituent	Factor “f”
All aggregate passing: 1½", 1", ¾", ½", ⅜" and No.4 sieves	2
All aggregate passing No. 8 sieve	15

Table of Price Adjustment Factors	
Constituent	Factor "f"
All aggregate passing No. 200 sieve	20
Asphalt binder	40
Air Voids (Va) (where applicable)	20

Each lot of HMA produced under Nonstatistical Evaluation and having all constituents falling within the tolerance limits of the job mix formula shall be accepted at the unit Contract price with no further evaluation. When one or more constituents fall outside the nonstatistical tolerance limits in the Job Mix Formula shown in Table of Price Adjustment Factors, the lot shall be evaluated in accordance with Section 1-06.2 to determine the appropriate CPF. The nonstatistical tolerance limits will be used in the calculation of the CPF and the maximum CPF shall be 1.00. When less than three sublots exist, backup samples of the existing sublots or samples from the Roadway shall be tested to provide a minimum of three sets of results for evaluation.

5-04.3(9)C5 Vacant

5-04.3(9)C6 Mixture Nonstatistical Evaluation – Price Adjustments

For each lot of HMA mix produced under Nonstatistical Evaluation when the calculated CPF is less than 1.00, a Nonconforming Mix Factor (NCMF) will be determined. The NCMF equals the algebraic difference of CPF minus 1.00 multiplied by 60 percent. The total job mix compliance price adjustment will be calculated as the product of the NCMF, the quantity of HMA in the lot in tons, and the unit Contract price per ton of mix.

If a constituent is not measured in accordance with these Specifications, its individual pay factor will be considered 1.00 in calculating the Composite Pay Factor (CPF).

5-04.3(9)C7 Mixture Nonstatistical Evaluation - Retests

The Contractor may request a subplot be retested. To request a retest, the Contractor shall submit a written request within 7 calendar days after the specific test results have been received. A split of the original acceptance sample will be retested. The split of the sample will not be tested with the same tester that ran the original acceptance test. The sample will be tested for a complete gradation analysis, asphalt binder content, and, at the option of the agency, Va. The results of the retest will be used for the acceptance of the HMA in place of the original subplot sample test results. The cost of testing will be deducted from any monies due or that may come due the Contractor under the Contract at the rate of \$500 per sample.

5-04.3 (9)D Mixture Acceptance – Commercial Evaluation

If sampled and tested, HMA produced under Commercial Evaluation and having all constituents falling within the tolerance limits of the job mix formula shall be accepted at the unit Contract price with no further evaluation. When one or more constituents fall outside the commercial tolerance limits in the Job Mix Formula shown in 5-04.3(9), the lot shall be evaluated in accordance with Section 1-06.2 to determine the appropriate CPF. The commercial tolerance limits will be used in the calculation of the CPF and the maximum CPF shall be 1.00. When less than three sublots exist, backup

samples of the existing sublots or samples from the street shall be tested to provide a minimum of three sets of results for evaluation.

For each lot of HMA mix produced and tested under Commercial Evaluation when the calculated CPF is less than 1.00, a Nonconforming Mix Factor (NCMF) will be determined. The NCMF equals the algebraic difference of CPF minus 1.00 multiplied by 60 percent. The Job Mix Compliance Price Adjustment will be calculated as the product of the NCMF, the quantity of HMA in the lot in tons, and the unit Contract price per ton of mix.

If a constituent is not measured in accordance with these Specifications, its individual pay factor will be considered 1.00 in calculating the Composite Pay Factor (CPF).

5-04.3(10) HMA Compaction Acceptance

HMA mixture accepted by nonstatistical evaluation that is used in traffic lanes, including lanes for intersections, ramps, truck climbing, weaving, and speed change, and having a specified compacted course thickness greater than 0.10-foot, shall be compacted to a specified level of relative density. The specified level of relative density shall be a Composite Pay Factor (CPF) of not less than 0.75 when evaluated in accordance with Section 1-06.2, using a minimum of 92 percent of the maximum density. The maximum density shall be determined by WSDOT FOP for AASHTO T 729. The specified level of density attained will be determined by the evaluation of the density of the pavement. The density of the pavement shall be determined in accordance with WSDOT FOP for WAQTC TM 8, except that gauge correlation will be at the discretion of the Engineer, when using the nuclear density gauge and WSDOT SOP 736 when using cores to determine density.

Tests for the determination of the pavement density will be taken in accordance with the required procedures for measurement by a nuclear density gauge or roadway cores after completion of the finish rolling.

If the Contracting Agency uses a nuclear density gauge to determine density the test procedures FOP for WAQTC TM 8 and WSDOT SOP T 729 will be used on the day the mix is placed and prior to opening to traffic.

Roadway cores for density may be obtained by either the Contracting Agency or the Contractor in accordance with WSDOT SOP 734. The core diameter shall be 4-inches minimum, unless otherwise approved by the Engineer. Roadway cores will be tested by the Contracting Agency in accordance with WSDOT FOP for AASHTO T 166.

If the Contract includes the Bid item "Roadway Core" the cores shall be obtained by the Contractor in the presence of the Engineer on the same day the mix is placed and at locations designated by the Engineer. If the Contract does not include the Bid item "Roadway Core" the Contracting Agency will obtain the cores.

For a lot in progress with a CPF less than 0.75, a new lot will begin at the Contractor's request after the Engineer is satisfied that material conforming to the Specifications can be produced.

A lot is represented by randomly selected samples of the same mix design that will be tested for acceptance. A lot is defined as the total quantity of material or work produced for each Job Mix Formula placed. Only one lot per JMF is expected. A subplot shall be equal to one day's production

or 400 tons, whichever is less except that the final subplot will be a minimum of 200 tons and may be increased to 800 tons. Testing for compaction will be at the rate of 5 tests per subplot per WSDOT T 738.

HMA mixture accepted by commercial evaluation and HMA constructed under conditions other than those listed above shall be compacted on the basis of a test point evaluation of the compaction train. The test point evaluation shall be performed in accordance with instructions from the Engineer. The number of passes with an approved compaction train, required to attain the maximum test point density, shall be used on all subsequent paving.

HMA for preleveling shall be thoroughly compacted. HMA that is used for preleveling wheel rutting shall be compacted with a pneumatic tire roller unless otherwise approved by the Engineer.

Test Results

For a subplot that has been tested with a nuclear density gauge that did not meet the minimum of 92 percent of the reference maximum density in a compaction lot with a CPF below 1.00 and thus subject to a price reduction or rejection, the Contractor may request that a core be used for determination of the relative density of the subplot. The relative density of the core will replace the relative density determined by the nuclear density gauge for the subplot and will be used for calculation of the CPF and acceptance of HMA compaction lot.

When cores are taken by the Contracting Agency at the request of the Contractor, they shall be requested by noon of the next workday after the test results for the subplot have been provided or made available to the Contractor. Core locations shall be outside of wheel paths and as determined by the Engineer. Traffic control shall be provided by the Contractor as requested by the Engineer. Failure by the Contractor to provide the requested traffic control will result in forfeiture of the request for cores. When the CPF for the lot based on the results of the HMA cores is less than 1.00, the cost for the coring will be deducted from any monies due or that may become due the Contractor under the Contract at the rate of \$200 per core and the Contractor shall pay for the cost of the traffic control.

5-04.3(10)A HMA Compaction – General Compaction Requirements

Compaction shall take place when the mixture is in the proper condition so that no undue displacement, cracking, or shoving occurs. Areas inaccessible to large compaction equipment shall be compacted by other mechanical means. Any HMA that becomes loose, broken, contaminated, shows an excess or deficiency of asphalt, or is in any way defective, shall be removed and replaced with new hot mix that shall be immediately compacted to conform to the surrounding area.

The type of rollers to be used and their relative position in the compaction sequence shall generally be the Contractor's option, provided the specified densities are attained. Unless the Engineer has approved otherwise, rollers shall only be operated in the static mode when the internal temperature of the mix is less than 175°F. Regardless of mix temperature, a roller shall not be operated in a mode that results in checking or cracking of the mat. Rollers shall only be operated in static mode on bridge decks.

5-04.3(10)B HMA Compaction – Cyclic Density

Low cyclic density areas are defined as spots or streaks in the pavement that are less than 90 percent of the theoretical maximum density. At the Engineer's discretion, the Engineer may evaluate the HMA pavement for low cyclic density, and when doing so will follow WSDOT SOP 733. A \$500 Cyclic Density

Price Adjustment will be assessed for any 500-foot section with two or more density readings below 90 percent of the theoretical maximum density.

5-04.3(10)C Vacant

5-04.3(10)D HMA Nonstatistical Compaction

5-04.3(10)D1 HMA Nonstatistical Compaction – Lots and Sublots

HMA compaction which is accepted by nonstatistical evaluation will be based on acceptance testing performed by the Contracting Agency dividing the project into compaction lots.

A lot is represented by randomly selected samples of the same mix design that will be tested for acceptance, with a maximum of 15 sublots per lot; the final lot for a mix design may be increased to 25 sublots. Sublots will be uniform in size with a maximum subplot size based on original Plan quantity tons of HMA as specified in the table below. The subplot locations within each density lot will be determined by the Engineer. For a lot in progress with a CPF less than 0.75, a new lot will begin at the Contractor's request after the Engineer is satisfied that material conforming to the Specifications can be produced.

HMA Original Plan Quantity (tons)	Sublot Size (tons)
<20,000	100
20,000 to 30,000	150
>30,000	200

HMA mixture accepted by commercial evaluation and HMA constructed under conditions other than those listed above shall be compacted on the basis of a test point evaluation of the compaction train. The test point evaluation shall be performed in accordance with instructions from the Engineer. The number of passes with an approved compaction train, required to attain the maximum test point density, shall be used on all subsequent paving.

HMA for preleveling shall be thoroughly compacted. HMA that is used to prelevel wheel ruts shall be compacted with a pneumatic tire roller unless otherwise approved by the Engineer.

5-04.3(10)D2 HMA Compaction Nonstatistical Evaluation – Acceptance Testing

The location of the HMA compaction acceptance tests will be randomly selected by the Engineer from within each subplot, with one test per subplot.

5-04.3(10)D3 HMA Nonstatistical Compaction – Price Adjustments

For each compaction lot with one or two sublots, having all sublots attain a relative density that is 92 percent of the reference maximum density the HMA shall be accepted at the unit Contract price with no further evaluation. When a subplot does not attain a relative density that is 92 percent of the reference maximum density, the lot shall be evaluated in accordance with Section 1-06.2 to determine the appropriate CPF. The maximum CPF shall be 1.00, however, lots with a calculated CPF in excess of 1.00 will be used to offset lots with CPF values below 1.00 but greater than 0.90. Lots with CPF lower than 0.90 will be evaluated for compliance per 5-04.3(11). Additional testing by either

a nuclear moisture-density gauge or cores will be completed as required to provide a minimum of three tests for evaluation.

For compaction below the required 92% a Non-Conforming Compaction Factor (NCCF) will be determined. The NCCF equals the algebraic difference of CPF minus 1.00 multiplied by 40 percent. The Compaction Price Adjustment will be calculated as the product of CPF, the quantity of HMA in the compaction control lot in tons, and the unit Contract price per ton of mix.

5-04.3(11) Reject Work

5-04.3(11)A Reject Work General

Work that is defective or does not conform to Contract requirements shall be rejected. The Contractor may propose, in writing, alternatives to removal and replacement of rejected material. Acceptability of such alternative proposals will be determined at the sole discretion of the Engineer. HMA that has been rejected is subject to the requirements in Section 1-06.2(2) and this specification, and the Contractor shall submit a corrective action proposal to the Engineer for approval.

5-04.3(11)B Rejection by Contractor

The Contractor may, prior to sampling, elect to remove any defective material and replace it with new material. Any such new material will be sampled, tested, and evaluated for acceptance.

5-04.3(11)C Rejection Without Testing (Mixture or Compaction)

The Engineer may, without sampling, reject any batch, load, or section of Roadway that appears defective. Material rejected before placement shall not be incorporated into the pavement. Any rejected section of Roadway shall be removed.

No payment will be made for the rejected materials or the removal of the materials unless the Contractor requests that the rejected material be tested. If the Contractor elects to have the rejected material tested, a minimum of three representative samples will be obtained and tested. Acceptance of rejected material will be based on conformance with the nonstatistical acceptance Specification. If the CPF for the rejected material is less than 0.75, no payment will be made for the rejected material; in addition, the cost of sampling and testing shall be borne by the Contractor. If the CPF is greater than or equal to 0.75, the cost of sampling and testing will be borne by the Contracting Agency. If the material is rejected before placement and the CPF is greater than or equal to 0.75, compensation for the rejected material will be at a CPF of 0.75. If rejection occurs after placement and the CPF is greater than or equal to 0.75, compensation for the rejected material will be at the calculated CPF with an addition of 25 percent of the unit Contract price added for the cost of removal and disposal.

5-04.3(11)D Rejection - A Partial Sublot

In addition to the random acceptance sampling and testing, the Engineer may also isolate from a normal sublot any material that is suspected of being defective in relative density, gradation or asphalt binder content. Such isolated material will not include an original sample location. A minimum of three random samples of the suspect material will be obtained and tested. The material will then be statistically evaluated as an independent lot in accordance with Section 1-06.2(2).

5-04.3(11)E Rejection - An Entire Sublot

An entire subplot that is suspected of being defective may be rejected. When a subplot is rejected a minimum of two additional random samples from this subplot will be obtained. These additional samples and the original subplot will be evaluated as an independent lot in accordance with Section 1-06.2(2).

5-04.3(11)F Rejection - A Lot in Progress

The Contractor shall shut down operations and shall not resume HMA placement until such time as the Engineer is satisfied that material conforming to the Specifications can be produced:

1. When the Composite Pay Factor (CPF) of a lot in progress drops below 1.00 and the Contractor is taking no corrective action, or
2. When the Pay Factor (PF) for any constituent of a lot in progress drops below 0.95 and the Contractor is taking no corrective action, or
3. When either the PF_i for any constituent or the CPF of a lot in progress is less than 0.75.

5-04.3(11)G Rejection - An Entire Lot (Mixture or Compaction)

An entire lot with a CPF of less than 0.75 will be rejected.

5-04.3(12) Joints

5-04.3(12)A HMA Joints

5-04.3(12)A1 Transverse Joints

The Contractor shall conduct operations such that the placing of the top or wearing course is a continuous operation or as close to continuous as possible. Unscheduled transverse joints will be allowed and the roller may pass over the unprotected end of the freshly laid mixture only when the placement of the course must be discontinued for such a length of time that the mixture will cool below compaction temperature. When the Work is resumed, the previously compacted mixture shall be cut back to produce a slightly beveled edge for the full thickness of the course.

A temporary wedge of HMA constructed on a 20H:1V shall be constructed where a transverse joint as a result of paving or planing is open to traffic. The HMA in the temporary wedge shall be separated from the permanent HMA by strips of heavy wrapping paper or other methods approved by the Engineer. The wrapping paper shall be removed and the joint trimmed to a slightly beveled edge for the full thickness of the course prior to resumption of paving.

The material that is cut away shall be wasted and new mix shall be laid against the cut. Rollers or tamping irons shall be used to seal the joint.

All transverse (butt) joints between new and existing asphalt shall be milled to the full overlay depth as listed on the Summary of Quantities located in Appendix A.

All transverse (butt) joints shall be sealed after paving. See Section 5-04.3(17) for requirements.

5-04.3(12)A2 Longitudinal Joints

The longitudinal joint in any one course shall be offset from the course immediately below by not more than 6 inches nor less than 2 inches. All longitudinal joints constructed in the wearing course shall be located at a lane line or an edge line of the Traveled Way. A notched wedge joint shall be constructed along all longitudinal joints in the wearing surface of new HMA unless otherwise

approved by the Engineer. The notched wedge joint shall have a vertical edge of not less than the maximum aggregate size or more than $\frac{1}{2}$ of the compacted lift thickness and then taper down on a slope not steeper than 4H:1V. The sloped portion of the HMA notched wedge joint shall be uniformly compacted.

5-04.3(12)B Bridge Paving Joint Seals

5-04.3(12)B1 HMA Sawcut and Seal

Prior to placing HMA on the bridge deck, establish sawcut alignment points at both ends of the bridge paving joint seals to be placed at the bridge ends, and at interior joints within the bridge deck when and where shown in the Plans. Establish the sawcut alignment points in a manner that they remain functional for use in aligning the sawcut after placing the overlay.

Submit a Type 1 Working Drawing consisting of the sealant manufacturer's application procedure.

Construct the bridge paving joint seal as specified on the Plans and in accordance with the detail shown in the Standard Plans. Construct the sawcut in accordance with the detail shown in the Standard Plan. Construct the sawcut in accordance with Section 5-05.3(8)B and the manufacturer's application procedure.

5-04.3(12)B2 Paved Panel Joint Seal

Construct the paved panel joint seal in accordance with the requirements specified in Section 5-04.3(12)B1 and the following requirement:

1. Clean and seal the existing joint between concrete panels in accordance with Section 5-01.3(8) and the details shown in the Standard Plans.

5-04.3(13) Surface Smoothness

The completed surface of all courses shall be of uniform texture, smooth, uniform as to crown and grade, and free from defects of all kinds. The completed surface of the wearing course shall not vary more than ~~$\frac{1}{8}$ inch~~ $\frac{1}{4}$ inch from the lower edge of a 10-foot straightedge placed on the surface parallel to the centerline. The transverse slope of the completed surface of the wearing course shall vary not more than $\frac{1}{4}$ inch in 10 feet from the rate of transverse slope ~~shown in the Plans.~~ of the existing street surface.

When deviations in excess of the above tolerances are found that result from a high place in the HMA, the pavement surface shall be corrected by one of the following methods:

1. Removal of material from high places by grinding with an approved grinding machine, or
2. Removal and replacement of the wearing course of HMA, or
3. By other method approved by the Engineer.

Correction of defects shall be carried out until there are no deviations anywhere greater than the allowable tolerances.

Deviations in excess of the above tolerances that result from a low place in the HMA and deviations resulting from a high place where corrective action, in the opinion of the Engineer, will not produce satisfactory results will be accepted with a price adjustment. The Engineer shall deduct from monies due or that may become due to the Contractor the sum of \$500.00 for each and every section of single traffic lane 100 feet in length in which any excessive deviations described above are found.

When utility appurtenances such as manhole covers and valve boxes are located in the traveled way, the utility appurtenances shall be adjusted to the finished grade prior to paving. This requirement may be waived when requested by the Contractor, at the discretion of the Engineer or when the adjustment details provided in the project plan or specifications call for utility appurtenance adjustments after the completion of paving. For this contract, utility appurtenances shall be adjusted to final grade after paving, unless otherwise directed by the Engineer. See Section 5-04.3(20) for requirements.

Utility appurtenance adjustment discussions will be included in the Pre-Paving ~~planning~~ planing (5-04.3(14)B3). Submit a written request to waive this requirement to the Engineer prior to the start of paving.

5-04.3(14) Planing (Milling) Bituminous Pavement

The ~~planning~~ planing plan must be approved by the Engineer and a pre ~~planning~~ planing meeting must be held prior to the start of any planing. See Section 5-04.3(14)B2 for information on ~~planning~~ planing submittals.

Prior to planing operations, existing induction loop vehicle detectors shall be disconnected. Induction loop vehicle detectors shall be removed during planing operations.

The planing operation on any street and/or street segment shall not precede the HMA paving operation by more than three (3) calendar days, unless otherwise allowed by the Engineer.

Locations of existing surfacing to be planed are as shown in the Drawings. Refer to the Summary of Quantities in Appendix A for the list of streets and/or street segments to be planed in this contract. The depth of planing shall match the thickness of HMA to be placed, as listed on the Summary of Quantities.

Where planing an existing pavement is specified in the Contract, the Contractor must remove existing surfacing material and to reshape the surface to remove irregularities. The finished product must be a prepared surface acceptable for receiving an HMA overlay.

Use the cold milling method for planing unless otherwise specified in the Contract. Do not use the planer on the final wearing course of new HMA.

Conduct planing operations in a manner that does not tear, break, burn, or otherwise damage the surface which is to remain. The finished planed surface must be slightly grooved or roughened and must be free from gouges, deep grooves, ridges, or other imperfections. The Contractor must repair any damage to the surface by the Contractor's planing equipment, using an Engineer approved method.

Repair or replace any metal castings and other surface improvements damaged by planing, as determined by the Engineer.

~~A tapered wedge cut must be planed longitudinally along curb lines sufficient to provide a minimum of 4 inches of curb reveal after placement and compaction of the final wearing course. The dimensions of the wedge must be as shown on the Drawings or as specified by the Engineer.~~

~~A tapered wedge cut must also be made at transitions to adjoining pavement surfaces (meet lines) where butt joints are shown on the Drawings. Cut butt joints in a straight line with vertical faces 2 inches or more in height, producing a smooth transition to the existing adjoining pavement.~~

~~After planing is complete, planed surfaces must be swept, cleaned, and if required by the Contract or as directed by the Engineer, patched and preleveled- before opening planed areas to traffic.~~

The Contractor shall provide for safe vehicular travel over existing utility appurtenances during and after planing operations. For utility appurtenances not lowered prior to planing operations, the Contractor shall place temporary fillets of HMA, with a minimum slope of 4H:1V, around all exposed utility appurtenances if any vehicular traffic will be permitted to travel through the work area prior to paving. The HMA used for this purpose shall be considered an incidental use of HMA as described in Section 5-04.3(18).

The Contractor shall provide for safe vehicular travel over driveway entrances during and after planing operations. If the depth of exposed curb or drop off exceeds two (2) inches at a driveway and paving is not occur in the same work shift, the Contractor shall place temporary fillets of HMA along the driveway to provide a transition with a minimum slope of 4H:1V. The HMA used for this purpose shall be considered incidental use of HMA as described in Section 5-04.3(18).

The Engineer may direct additional depth planing. Before performing this additional depth planing, the Contractor must conduct a hidden metal in pavement detection survey as specified in Section 5-04.3(14)A.

5-04.3(14)A Pre-Planing Metal Detection Check

Before starting planing of pavements, and before any additional depth planing required by the Engineer, the Contractor must conduct a physical survey of existing pavement to be planed with equipment that can identify hidden metal objects.

Should such metal be identified, promptly notify the Engineer.

See Section 1-07.16(1) regarding the protection of survey monumentation that may be hidden in pavement.

The Contractor is solely responsible for any damage to equipment resulting from the Contractor's failure to conduct a pre-planing metal detection survey, or from the Contractor's failure to notify the Engineer of any hidden metal that is detected.

5-04.3(14)B Paving and Planing Under Traffic

5-04.3(14)B1 General

In addition the requirements of Section 1-07.23 and the traffic controls required in Section 1-10, and unless the Contract specifies otherwise or the Engineer approves, the Contractor must comply with the following:

1. Intersections:
 - a. Keep intersections open to traffic at all times, except when paving or planing operations through an intersection requires closure. Such closure must be kept to the minimum time required to place and compact the HMA mixture, or plane as appropriate. For paving, schedule such closure to individual lanes or portions thereof that allows the traffic volumes and schedule of traffic volumes required in the approved traffic control plan. Schedule work so that adjacent intersections are not impacted at the same time and comply with the traffic control restrictions required by the Traffic Engineer. Each individual intersection closure or partial closure, must be addressed in the traffic control plan, which must be submitted to and accepted by the Engineer, see Section 1-10.2(2).
 - b. When planing or paving and related construction must occur in an intersection, consider scheduling and sequencing such work into quarters of the intersection, or half or more of an intersection with side street detours. Be prepared to sequence the work to individual lanes or portions thereof.
 - c. Should closure of the intersection in its entirety be necessary, and no trolley service is impacted, keep such closure to the minimum time required to place and compact the HMA mixture, plane, remove asphalt, tack coat, and as needed.
 - d. Any work in an intersection requires advance warning in both signage and a number of Working Days advance notice as determined by the Engineer, to alert traffic and emergency services of the intersection closure or partial closure.
 - e. Allow new compacted HMA asphalt to cool to ambient temperature before any traffic is allowed on it. Traffic is not allowed on newly placed asphalt until approval has been obtained from the Engineer.
2. Temporary centerline marking, post-paving temporary marking, temporary stop bars, and maintaining temporary pavement marking must comply with Section 8-23.
3. Permanent pavement marking must comply with Section 8-22.

5-04.3(14)B2 Submittals – Planing Plan and HMA Paving Plan

The Contractor must submit a separate planing plan and a separate paving plan to the Engineer at least 5 Working Days in advance of each operation's activity start date. These plans must show how the moving operation and traffic control are coordinated, as they will be discussed at the pre-planing briefing and pre-paving briefing. When requested by the Engineer, the Contractor must provide each operation's traffic control plan on ~~24 x 36 inch~~ 11 x 17 inch or larger size Shop Drawings with a scale showing both the area of operation and sufficient detail of traffic beyond the area of operation where detour traffic may be required. The scale on the Shop Drawings is 1 inch = ~~20 feet~~ 100 feet, which may be changed if the Engineer agrees sufficient detail is shown.

The planing operation and the paving operation include, but are not limited to, metal detection, removal of asphalt and temporary asphalt of any kind, tack coat and drying, staging of supply trucks, paving trains, rolling, scheduling, and as may be discussed at the briefing.

When intersections will be partially or totally blocked, provide adequately sized and noticeable signage alerting traffic of closures to come, a minimum 2 Working Days in advance. The traffic control plan must show where peace officers will be stationed when signalization is or may be, countermanded, and show areas where flaggers are proposed.

At a minimum, the planing and the paving plan must include:

1. A copy of the accepted traffic control plan, see Section 1-10.2(2), detailing each day's traffic control as it relates to the specific requirements of that day's planing and paving. Briefly describe the sequencing of traffic control consistent with the proposed planing and paving sequence, and scheduling of placement of temporary pavement markings and channelizing devices after each day's planing, and paving.
2. A copy of each intersection's traffic control plan.
3. Haul routes from Supplier facilities, and locations of temporary parking and staging areas, including return routes. Describe the complete round trip as it relates to the sequencing of paving operations.
4. Names and locations of HMA Supplier facilities to be used.
5. List of all equipment to be used for paving.
6. List of personnel and associated job classification assigned to each piece of paving equipment.
7. Description (geometric or narrative) of the scheduled sequence of planing and of paving, and intended area of planing and of paving for each day's work, must include the directions of proposed planing and of proposed paving, sequence of adjacent lane paving, sequence of skipped lane paving, intersection planing and paving scheduling and sequencing, and proposed notifications and coordinations to be timely made. The plan must show HMA joints relative to the final pavement marking lane lines.
8. Names, job titles, and contact information for field, office, and plant supervisory personnel.
9. A copy of the approved Mix Designs.
10. Tonnage of HMA to be placed each day.
11. Approximate times and days for starting and ending daily operations.

5-04.3(14)B3 Pre-Paving and Pre-Planing Briefing

At least 2 Working Days before the first paving operation and the first planing operation, or as scheduled by the Engineer for future paving and planing operations to ensure the Contractor has adequately prepared for notifying and coordinating as required in the Contract, the Contractor must be prepared to discuss that day's operations as they relate to other entities and to public safety and convenience, including driveway and business access, garbage truck operations, Metro transit operations and working around energized overhead wires, school and nursing home and hospital and other accesses, other contractors who may be operating in the area, pedestrian and bicycle traffic, and emergency services. The Contractor, and Subcontractors that may be part of that day's operations, must meet with the Engineer and discuss the proposed operation as it relates to the submitted planing plan and paving plan, approved traffic control plan, and public convenience and safety. Such discussion includes, but is not limited to:

1. General for both Paving Plan and for Planing Plan:
 - a. The actual times of starting and ending daily operations.
 - b. In intersections, how to break up the intersection, and address traffic control and signalization for that operation, including use of peace officers.

- c. The sequencing and scheduling of paving operations and of planing operations, as applicable, as it relates to traffic control, to public convenience and safety, and to other contractors who may operate in the Project Site.
 - d. Notifications required of Contractor activities, and coordinating with other entities and the public as necessary.
 - e. Description of the sequencing of installation and types of temporary pavement markings as it relates to ~~planning~~ planing and to paving.
 - f. Description of the sequencing of installation of, and the removal of, temporary pavement patch material around exposed castings and as may be needed
 - g. Description of procedures and equipment to identify hidden metal in the pavement, such as survey monumentation, monitoring wells, street car rail, and castings, before ~~planning~~ planing, see Section 5-04.3(14)B2.
 - h. Description of how flaggers will be coordinated with the planing, paving, and related operations.
 - i. Description of sequencing of traffic controls for the process of rigid pavement base repairs.
 - j. Other items the Engineer deems necessary to address.
2. Paving – additional topics:
- a. When to start applying tack and coordinating with paving.
 - b. Types of equipment and numbers of each type equipment to be used. If more pieces of equipment than personnel are proposed, describe the sequencing of the personnel operating the types of equipment. Discuss the continuance of operator personnel for each type equipment as it relates to meeting Specification requirements.
 - c. Number of JMFs to be placed, and if more than one JMF how the Contractor will ensure different JMFs are distinguished, how pavers and MTVs are distinguished if more than one JMF is being placed at the time, and how pavers and MTVs are cleaned so that one JMF does not adversely influence the other JMF.
 - d. Description of contingency plans for that day's operations such as equipment breakdown, rain out, and Supplier shutdown of operations.
 - e. Number of sublots to be placed, sequencing of density testing, and other sampling and testing.

5-04.3(15) Sealing Pavement Surfaces

Apply a fog seal where shown in the plans. Construct the fog seal in accordance with Section 5-02.3. Unless otherwise approved by the Engineer, apply the fog seal prior to opening to traffic.

5-04.3(16) HMA Road Approaches

HMA approaches shall be constructed at the locations shown in the Plans or where staked by the Engineer. The Work shall be performed in accordance with Section 5-04.

5-04.3(17) Construction Joint Sealing

Transverse Joints - Joints between new and existing asphalt shall be sealed within five (5) calendar days after final rolling of the final lift of HMA. The seal shall be CSS-1 emulsified asphalt. The emulsified asphalt shall be placed in a way to be smooth and flush with roadway surface with minimal overbanding. This work is considered incidental to the bid item "HMA CL. ½" PG 64-22".

5-04.3(18) Incidental Uses for HMA

Incidental uses for HMA shall consist of restoration and adjustment to paved areas and other such uses as directed by the Engineer. For example, a thickened edge may be required for some streets

and/or street segment(s). Incidental uses for HMA shall be measured and paid under the "HMA CL. ½" PG 64-22" bid item for the overlay related HMA and "HMA for Pavement Repair CL ½" PG 64-22" bid item for full depth spot repair related HMA.

5-04.3(19) Edge of Pavement Alignment

Where curb and gutter do not exist, the Contractor shall maintain a ± 2 inches per 100 linear feet tolerance for the edge of pavement. The Contractor may establish a reference line as a guide at their discretion or as directed by the Engineer. This work is considered incidental to the bid item "HMA CL. ½" PG 64-22".

5-04.3(20) Adjusting Utility Covers and Monument Cases to Final Grade

The following section only applies to existing utility covers and monument cases covered by HMA. The work shall be completed after the final rolling of the final lift of HMA. The work consists of locating and marking these features and then adjusting them final grade.

The Contractor shall locate all utility covers and monument cases covered by HMA immediately after paving operations are complete for a street and/or street segment. Each location shall be marked with paint and identify the type of buried feature. The Contractor shall completely expose all water valve boxes and gas valves for access within five (5) calendar days after final rolling of the final lift of HMA.

The Contractor shall adjust the following features to final grade per the requirements listed below.

Manholes – Refer to Renton Standard Plan 106 included in Appendix C.

Water Valve Boxes – Refer to Renton Standard Plan 330.1 in Appendix C.

Gas Valves – Same as Water Valve Boxes.

Monument Cases – Refer to Renton Standard Plan 113 in Appendix C.

J-boxes, Electrical Vaults, Communications Vaults – These features shall not to be covered with HMA.

5-04.3(21) Temporary Pavement Marking

The furnishing and installing of temporary pavement marking shall be as described in Section 8-23. For this contract, all temporary pavement marking is considered short duration.

5-04.4 Measurement

HMA Cl. ___ PG ___, HMA for ___ Cl. ___ PG ___, and Commercial HMA will be measured by the ton in accordance with Section 1-09.2, with no deduction being made for the weight of asphalt binder, mineral filler, or any other component of the mixture. If the Contractor elects to remove and replace mix as allowed by Section 5-04.3(11), the material removed will not be measured.

Roadway cores will be measured per each for the number of cores taken.

Preparation of untreated roadway will be measured by the mile once along the centerline of the main line Roadway. No additional measurement will be made for ramps, Auxiliary Lanes, service roads, Frontage Roads, or Shoulders. Measurement will be to the nearest 0.01 mile.

Soil residual herbicide will be measured by the mile for the stated width to the nearest 0.01 mile or by the square yard, whichever is designated in the Proposal.

Pavement repair excavation will be measured by the square yard of surface marked prior to excavation.

Asphalt for prime coat will be measured by the ton in accordance with Section 1-09.2.

Prime coat aggregate will be measured by the cubic yard, truck measure, or by the ton, whichever is designated in the Proposal.

Asphalt for fog seal will be measured by the ton, as provided in Section 5-02.4.

Longitudinal joint seals between the HMA and cement concrete pavement will be measured by the linear foot along the line and slope of the completed joint seal.

Planing bituminous pavement will be measured by the square yard.

Planing bituminous pavement to a 2 inch depth will be measured by the square yard.

Planing bituminous pavement to a 4 inch depth will be measured by the square yard.

Temporary pavement marking will be measured by the linear foot as provided in Section 8-23.4.

Water will be measured by the M gallon as provided in Section 2-07.4.

Adjust Manhole Cover will be measured per each.

Adjust Water Valve Box will be measured per each.

Adjust Gas Valve will be measured per each.

Adjust Monument Case will be measured per each.

5-04.5 Payment

Payment will be made for each of the following Bid items that are included in the Proposal:

“HMA Cl. ___ PG ___”, per ton.

“HMA for Approach Cl. ___ PG ___”, per ton.

“HMA for Preleveling Cl. ___ PG ___”, per ton.

“HMA for Pavement Repair Cl. ___ PG ___”, per ton.

“Commercial HMA”, per ton.

The unit Contract price per ton for "HMA Cl. ___ PG ___", "HMA for Approach Cl. ___ PG ___", "HMA for Preleveling Cl. ___ PG ___", "HMA for Pavement Repair Cl. ___ PG ___", and "Commercial HMA" shall be full compensation for all costs, including anti-stripping additive, incurred to carry out the requirements of Section 5-04 except for those costs included in other items which are included in this Subsection and which are included in the Proposal.

"Preparation of Untreated Roadway", per mile.

The unit Contract price per mile for "Preparation of Untreated Roadway" shall be full pay for all Work described under 5-04.3(4), with the exception, however, that all costs involved in patching the Roadway prior to placement of HMA shall be included in the unit Contract price per ton for "HMA Cl. ___ PG ___" which was used for patching. If the Proposal does not include a Bid item for "Preparation of Untreated Roadway", the Roadway shall be prepared as specified, but the Work shall be included in the Contract prices of the other items of Work.

"Preparation of Existing Paved Surfaces", per mile.

The unit Contract Price for "Preparation of Existing Paved Surfaces" shall be full pay for all Work described under Section 5-04.3(4) with the exception, however, that all costs involved in patching the Roadway prior to placement of HMA shall be included in the unit Contract price per ton for "HMA Cl. ___ PG ___" which was used for patching. If the Proposal does not include a Bid item for "Preparation of Existing Paved Surfaces", the Roadway shall be prepared as specified, but the Work shall be included in the Contract prices of the other items of Work.

"Crack Sealing", by force account.

"Crack Sealing" will be paid for by force account as specified in Section 1-09.6. For the purpose of providing a common Proposal for all Bidders, the Contracting Agency has entered an amount in the Proposal to become a part of the total Bid by the Contractor.

"Pavement Repair Excavation Incl. Haul", per square yard.

The unit Contract price per square yard for "Pavement Repair Excavation Incl. Haul" shall be full payment for all costs incurred to perform the Work described in Section 5-04.3(4) with the exception, however, that all costs involved in the placement of HMA shall be included in the unit Contract price per ton for "HMA for Pavement Repair Cl. ___ PG ___", per ton.

"Asphalt for Prime Coat", per ton.

The unit Contract price per ton for "Asphalt for Prime Coat" shall be full payment for all costs incurred to obtain, provide and install the material in accordance with Section 5-04.3(4).

"Prime Coat Agg.", per cubic yard, or per ton.

The unit Contract price per cubic yard or per ton for "Prime Coat Agg." shall be full pay for furnishing, loading, and hauling aggregate to the place of deposit and spreading the aggregate in the quantities required by the Engineer.

“Asphalt for Fog Seal”, per ton.

Payment for “Asphalt for Fog Seal” is described in Section 5-02.5.

“Longitudinal Joint Seal”, per linear foot.

The unit Contract price per linear foot for “Longitudinal Joint Seal” shall be full payment for all costs incurred to perform the Work described in Section 5-04.3(12).

“Planing Bituminous Pavement”, per square yard.

“Planing Bituminous Pavement – 2 inch depth”, per square yard.

“Planing Bituminous Pavement – 4 inch depth”, per square yard.

The unit Contract price per square yard for “Planing Bituminous Pavement”, “Planing Bituminous Pavement – 2 inch depth”, “Planing Bituminous Pavement – 4 inch depth” shall be full payment for all costs incurred to perform the Work described in Section 5-04.3(14).

“Temporary Pavement Marking”, per linear foot.

Payment for “Temporary Pavement Marking” is described in Section 8-23.5.

“Water”, per M gallon.

Payment for “Water” is described in Section 2-07.5.

“Job Mix Compliance Price Adjustment”, by calculation.

“Job Mix Compliance Price Adjustment” will be calculated and paid for as described in Section 5-04.3(9)C6.

“Compaction Price Adjustment”, by calculation.

“Compaction Price Adjustment” will be calculated and paid for as described in Section 5-04.3(10)D3.

“Roadway Core”, per each.

The Contractor’s costs for all other Work associated with the coring (e.g., traffic control) shall be incidental and included within the unit Bid price per each and no additional payments will be made.

“Cyclic Density Price Adjustment”, by calculation.

“Cyclic Density Price Adjustment” will be calculated and paid for as described in Section 5-04.3(10)B.

“Adjust Manhole Cover”, per each.

“Adjust Water Valve Box”, per each.

“Adjust Gas Valve”, per each.

“Adjust Monument Case”, per each.

The unit Contract price per each for “Adjust Manhole Cover”, “Adjust Water Valve Box”, “Adjust Gas Valve”, “Adjust Monument Case” shall be full payment for all costs incurred to perform the Work described in Section 5-04.3(20).

5-06 TEMPORARY RESTORATION IN PAVEMENT AREA

Section 5-06 is new Section with subsections:

(*****)

5-06.1 Description

Pavement areas that have been removed by construction activities must be restored by the Contractor prior to the end of each working period. Within paved streets, driveways or sidewalks, the Contractor may use temporary pavement to allow vehicular/pedestrian traffic to travel over the construction areas. Temporary pavement shall be placed around trench plates or others devices used to cover construction activities in a manner that provides a smooth and safe transition between surfaces.

5-06.2 Materials

The asphalt pavement for temporary patches shall be 2” of a hot mix or cold mix asphalt composition determined by the Contractor to provide a product suitable for the intended application. The Contractor shall not use materials that are a safety or health hazard.

Temporary pavement material that does not form a consolidated surface after compaction shall be considered unsuitable and shall be removed from the site. Unsuitable temporary pavement shall be disposed of offsite.

5-06.3 Construction Requirements

The Contractor shall maintain temporary asphalt patches to the satisfaction of the governing road agency and the Engineer until said patch is replaced with permanent hot patch. The completed temporary pavement shall be free from ridges, ruts, bumps, depressions, objectionable marks, or other irregularities. The permanent hot mix asphalt patch shall be placed and sealed within 30 calendar days.

The Contractor shall immediately repair, patch, or remove any temporary pavement that does not provide a flat transition between existing pavement areas.

All temporary asphalt pavement shall be removed from the site by the end of the project and shall not be used as permanent asphalt pavement or subgrade material.

7-01 DRAINS

7-01.2 Materials

The second paragraph of Section 7-01.2 is revised with the following:

(*****)

Drain pipes may be concrete, zinc coated (galvanized) corrugated iron with Asphalt Treatment I, aluminum coated (aluminized) corrugated iron with Asphalt Treatment I, zinc coated (galvanized) steel with Asphalt Treatment I, corrugated aluminum alloy, polyvinyl chloride (PVC), corrugated polyethylene (PE), or corrugated polypropylene (PP) at the option of the Contractor unless the Plans specify the type to be used.

7-01.3 Construction Requirements

7-01.3(1) Drain Pipe

Section 7-01.3(1) is revised with the following:

(*****)

PVC drainpipe shall be jointed with a bell and spigot joint using a flexible elastomeric seal as described in Section 9-04.8. The bell shall be laid upstream. PE or ABS drainpipe shall be jointed with snap-on, screw-on, or wraparound coupling bands as recommended by the manufacturer of the tubing.

7-01.3(2) Underdrain Pipe

The second paragraph is revised with the following:

PVC under drain pipe shall be jointed using either the flexible elastomeric seal as described in Section 9-04.8 or solvent cement as described in Section 9-04.9, at the option of the Contractor unless otherwise specified in the Plans. The bell shall be laid upstream. PE or ABS drainage tubing under drain pipe shall be jointed with snap-on, screw-on, or wraparound coupling bands, as recommended by the manufacturer of the tubing.

7-01.4 Measurement

Section 7-01.4 is supplemented with the following:

(*****)

When the Contract does not include "Structure Excavation Class B" or "Structure Excavation Class B Including Haul" as a pay item all costs associated with these items shall be included in other contract pay items.

7-02 CULVERTS

7-02.2 Materials

The second paragraph of Section 7-02.2 is revised and supplemented with the following:

(*****)

Where steel or aluminum are referred to in this section in regard to a kind of culvert pipe, pipe arch, or end sections, it shall be understood that steel is zinc coated (galvanized) with Asphalt Treatment I or aluminum coated (aluminized) corrugated iron or steel, and aluminum is corrugated aluminum alloy as specified in Sections 9-05.4 and 9-05.5. Where plain or reinforced concrete, steel, or aluminum are referred to in Section 7-02 it shall be understood that reference is also made to PVC.

7-04 STORM SEWERS

7-04.2 Materials

The first paragraph of Section 7-04.2 is deleted in its entirety and replaced with the following:
 (*****)

Unless a pipe material is specifically called out on the Plans, materials shall meet the following requirements.

Size	Pipe Material Allowed	Specification
6-12"	Polypropylene Storm Sewer Pipe	9-05.24(2)
	Ductile Iron Pipe	9-05-13
	Corrugated Polyethylene Storm Sewer Pipe (CPEP)	9-05.20

Where bends are specifically called out on the plans, they shall be of the same material and manufacturer as the main pipe and meet the manufacturer’s recommendations.

The second paragraph of Section 7-04.2 is supplemented with the following:
 (*****)

The Contractor shall require pipe suppliers to furnish certificates signed by their authorized representative, stating the specifications to which the materials or products were manufactured. The Contractor shall provide 2 copies of these certifications to the Engineer for approval. Certificates showing nonconformance with the Contract shall be sufficient evidence for rejection. Approval of certificates shall be considered only as tentative acceptance of the materials and products, and such action by Engineer will not relieve Contractor of his/her responsibility to perform field tests and to replace or repair faulty materials, equipment, and/or workmanship and Contractor’s own expense.

Section 7-04.2 is supplemented with the following:
 (*****)

Dense foam shall meet 9-05.52 of these Special Provisions.

7-04.3 Construction Requirements

7-04.3(1) Cleaning and Testing

Section 7-04.3(1) is supplemented with the following:
 (*****)

Before testing begins and in adequate time to obtain approval through submittal process, prepare and submit test plan for approval by Engineer. Include testing procedures, methods, equipment, and tentative schedule. Obtain advance written approval for any deviations from Drawings and Specifications.

Repair, correct, and retest sections of pipe which fail to meet specified requirements when tested. Perform testing as work progresses. Schedule testing so that no more than 1000 linear feet of installed pipeline remains untested at one time.

Perform testing under observation of Engineer or Inspector.

Schedule testing during no rain. Plug the lower end of the pipe if needed to test pipe.

At the request of the Engineer, all pipe larger than 30-inch diameter shall have joints individually tested for Joint Tightness. Prior to final backfill, all joints shall be individually tested using low-pressure air per ASTM C1103. For the installation of any flexible pipe larger than 30-inches in diameter, the Contractor shall retain the services of a pipe manufacturer representative, knowledgeable in the installation methods and practices for the specific pipe product used on this project, as well as on the installation practices for flexible pipelines in general. The manufacturer's representative shall be present full time on site during the construction of the first 300 feet of pipe installation, and part-time, as required, thereafter until the entire pipeline installation is complete. The manufacturer's representative shall observe pipe foundation, pipe installation, placement and compaction of pipe zone bedding and backfill, and testing procedures. The manufacturer's representative shall notify Engineer and Contractor of any non-conforming installation, identifying the manufacturer recommended corrective action(s), within 24 hours of such occurrence. At the request of the Engineer, all flexible pipe shall be tested for maximum pipe deflection by pulling a rigid mandrel through the entire (i.e., 100%) flexible pipe length installed. Maximum deflection shall not exceed 5%. Mandrel testing shall conform to ASTM D3034, and be performed no sooner than 30 days after backfilling and prior to final acceptance testing of the segment. Submit test results to the Engineer.

1. Rigid mandrel shall have outside diameter (O.D.) equal to 95 percent of inside diameter (I.D.) of pipe. Inside diameter of pipe, for purpose of determining outside diameter of mandrel, shall be average outside diameter minus two minimum wall thicknesses for O.D. controlled pipe and average inside diameter for I.D. controlled pipe, dimensions shall be per appropriate standard. Statistical or other "tolerance packages" shall not be considered in mandrel sizing.
2. Rigid mandrel shall be constructed of metal or rigid plastic material that can withstand 200 psi without being deformed. Mandrel shall have nine or more "runners" or "legs" as long as total number of legs is odd number. Barrel section of mandrel shall have length of at least 75 percent of inside diameter of pipe. Rigid mandrel shall not have adjustable or collapsible legs which would allow reduction in mandrel diameter during testing. Provide and use proving ring for modifying each size mandrel.
3. Furnish "proving ring" with each mandrel. Fabricate ring of 1/2-inch-thick, 3-inch-wide bar steel to diameter 0.02 inches larger than approved mandrel diameter.
4. If a rigid mandrel is not available, the Contractor may substitute a round steel bar meeting #3 above.

"Testing Storm Sewer Pipe" shall be incidental to and included in storm sewer pipe bid items.

7-04.3(1)G Abandon Existing Storm Sewer Pipes

Section 7-04.3(1)G is a new section:

(*****)

Where it is shown on the plans that existing storm sewer pipe is to be abandoned by filling with grout, all abandonment of storm drain lines shall conform to Section 7-17.3(2)I.

7-04.3(2) CCTV Inspection

Section 7-04.3(2) is a new added section:

(*****)

All storm drain main lines constructed as part of this project shall be inspected by the use of closed-circuit television (CCTV) before substantial completion. The costs incurred in making the inspection shall be paid for under "CCTV Inspection".

All CCTV inspections for storm drain lines shall conform to Section 7-17.3(2)H.

7-04.3(3) Direct Pipe Connections

Section 7-04.3(3) is a new added section as follows:

(*****)

Direct Pipe Tee Connections:

Direct pipe tee connections for use in gravity-flow sewer and storm drainage direct connections to pipe shall be Inserta Tee service connections, as manufactured by Inserta Tee and shall meet ASTM F2946 and consist of a PVC hub, rubber sleeve, and stainless steel band. Connection shall be a compression fit into the cored wall of a mainline pipe. Hub shall be made from heavy-duty PVC material. Stainless steel clamping assembly shall be of SS #301 for the band and housing and SS #305 for screws. Rubber sleeve and gasket, when applicable, shall meet the requirements of ASTM F477. Gaskets shall be installed by the manufacturer. A water-based solution provided by the manufacturer shall be used during assembly. Inserta Tee product shall provide a water connection according to the requirements of ASTM D3212.

Field Pipe and Joint Performance: To assure water tightness, field performance verification may be accomplished by testing in accordance with ASTM F2487, ASTM F1417 or ASTM C1103. Appropriate safety precautions must be used when field-testing any pipe material. Contact the manufacturer for recommended leakage rates.

Installation: Installation shall be accordance with the manufacturer's recommended installation guidelines. Backfill around the Inserta Tee service connection shall be, at a minimum, of the same material type and compaction level as specified for the mainline pipe installation.

7-05 MANHOLES, INLETS, AND CATCH BASINS

7-05.3 Construction Requirements

Section 7-05.3 is supplemented with the following:

(*****)

All manholes shall be in accordance with City of Renton Standard Plans.

Connection to manholes or catch basins for storm sewer pipe less than 24-inch shall be "Kor-n-Seal" boot or approved equal.

Sanitary sewer pipe to sanitary sewer manhole connections shall be "Kor-n-Seal" boot or approved equal.

7-05.3(1) Adjusting Manholes and Catch Basins to Grade

Section 7-05.3(1) is replaced with the following:

(*****)

Where shown in the Plans or where directed by the Engineer, the existing manholes, catch basins, or inlets shall be adjusted to the grade as staked or otherwise designated by the Engineer.

The existing cast iron ring and cover on manholes and the catch basin frame and grate shall first be removed and thoroughly cleaned for reinstalling at the new elevation. From that point, the existing structure shall be raised or lowered to the required elevation.

The Contractor shall construct manholes so as to provide adjustment space for setting cover and casting to a finished grade as shown on the Construction Plans. Manhole ring and covers shall be adjusted to the finished elevations per Standard Plan 106 prior to final acceptance of the Work. Manholes in unimproved areas shall be adjusted to 6" above grade.

In unpaved streets: manholes, catch basins, and similar structures in areas to be surfaced with crushed rock or gravel shall be constructed to a point approximately eight inches below the subgrade and covered with a temporary wood cover. Existing manholes shall be cut off and covered in a similar manner. The Contractor shall carefully reference each manhole so that they may be easily found upon completion of the street Work. After placing the gravel or crushed stone surfacing, the manholes and manhole castings shall be constructed to the finished grade of the roadway surface. Excavation necessary for bringing manholes to grade shall center about the manhole and be held to the minimum area necessary. At the completion of the manhole adjustment, the void around the manhole shall be backfilled with materials which result in the section required on the typical roadway section, and be thoroughly compacted.

In cement concrete pavement: manholes, catch basins, and similar structures shall be constructed and adjusted in the same manner as outlined above except that the final adjustment shall be made and cast iron frame be set after forms have been placed and checked. In placing the concrete pavement, extreme care shall be taken not to alter the position of the casting in any way.

In asphalt concrete pavement: manholes shall not be adjusted until the pavement is completed, at which time the center of each manhole shall be carefully relocated from references previously established by the Contractor. The manhole shall then be brought to proper grade utilizing the same methods of construction as for the manhole itself. The cast iron frame shall be placed on the concrete grade rings and mortar. The complete patch shall match the existing paved surface for texture, density, and uniformity of grade. The joint between the patch and the existing pavement shall then be carefully painted with hot asphalt cement or asphalt emulsion and shall be immediately covered with dry paving sand before the asphalt cement solidifies.

Adjustment of inlets: The final alignment and grade of cast iron frames for new and old inlets to be adjusted to grade will be established from the forms or adjacent pavement surfaces. The final adjustment of the top of the inlet will be performed in similar manner to the above for manholes. On asphalt concrete paving projects using curb and gutter section, that portion of the cast iron frame not embedded in the gutter section shall be solidly embedded in asphalt also. The existing concrete pavement and edge of the casting shall be painted with hot asphalt cement. Adjustments in the inlet structure shall be constructed in the same manner and of the same material as that required for new inlets.

Monument cast iron frame and cover: monument castings shall be adjusted to grade in the same manner as for manholes.

Valve box castings: adjustments of valve box castings shall be made in the same manner as for manholes.

7-05.3(3) Connections to Existing Manholes

Section 7-05.3(3) is supplemented by adding the following:

(*****)

Where shown on the Plans, new drain pipes shall be connected to existing line, catch basin, curb inlets and/or manholes. The Contractor shall be required to core drill into the structure, shape the new pipe to fit and re-grout the opening in a workmanlike manner. Where directed by the Engineer or where shown on the Plans, additional structure channeling will be required.

Connections to existing sanitary sewer manholes shall be core drilled. Couplings shall be equal to "Kor-n-Seal" boots. Existing sanitary sewer manholes shall be cleaned, repaired, and re-channelled as necessary to match the new pipe configuration and as shown on the Construction Plans.

A "connection to existing" item will be allowed at any connection of a new line to an existing structure. No "connection to existing" will be accepted at the location of new installation, relocation and adjustment of line manholes, catch basins, or curb inlets.

The unit bid price per each shall be full compensation for all labor, materials and equipment required.

7-05.3(5) Manhole Coatings

Section 7-05.3(5) is an added new section:

(*****)

All interior surfaces of new precast concrete sanitary sewer manholes shall be shop coated in accordance with 9-08.8. Coating shall be applied in accordance with manufacturer's recommendations in a controlled environment before arriving on site. Field application of interior coating will not be accepted.

Coating Material:	High Solids Urethane
Surfaces:	Concrete
Surface Preparation:	In accordance with SSPC SP-7 (Sweep of brush off blast)
Application:	Shop The drying time between coats shall not exceed 24 hours in any case
System Thickness:	3.0-4.0 mils dry film
Coatings:	Primer: One coat of Wasser MC-Shieldcoat 100 (1.5.0-2.0 mils DFT) Finish: Two or more coats of Wasser MC-Shieldcoat 100 (min. 1.5-2.0 mils DFT)
Color:	White

7-06 TRENCH DRAINS (NEW SECTION)

Section 7-06 is a new section.

(*****)

7-06.1 Description

This Work consists of the construction of new trench drain in accordance with the plans and specifications.

7-06.2 Materials

Trench drain shall be Polydrain PDX 15" wide, or acceptable equal. Trench drain and supporting concrete shall be designed for HS20 loading. Grate shall be either Model #603 or #606 as determined by the City.

Submittals:

- A. Shop Drawings: Show a schematic plan of the total drainage system including fabrication details. Shop drawing shall indicate the number and type of each pre-sloped channels and non pre-sloped channels.
- B. Product Data: Manufacturer's catalog sheets, specifications, and installation instructions for each item specified.
- C. Samples: Section of trench drain and grate (minimum 6-inch length)
- D. Product Data:
 - 1. Concrete Design Mix: Submit proposed concrete design mix together with name and location of batching plant at least 28 days prior to the start of concrete work.
 - 2. Portland Cement: Brand and Manufacturer's name.
 - 3. Air-entraining Admixture: Brand and manufacturer's name.
 - 4. Water-reducing or High Range Water-reducing Admixture: Brand and manufacturer's name.
 - 5. Curing and Anti-Spalling Compound: Manufacturer's specifications and application instructions.

7-06.3 Construction Requirements

Cement concrete shall be constructed with air entrained concrete Class 4000 conforming to the requirements of Section 6-02. Applicable requirements for concrete curbs and gutters in Section 8-4.2 shall apply.

Trench drain shall be installed per manufacturer's recommendations and product installation procedures.

7-08 GENERAL PIPE INSTALLATION REQUIREMENTS

7-08.3 Construction Requirements

7-08.3(1)A Trenches

Section 7-08.3(1)A is supplemented with the following:

(*****)

Trench Excavation Incl. Haul includes the trench excavation for the storm sewer, sanitary sewer, and water main construction in accordance with the trench limits outlined on the plan drawings. All trench excavated materials shall be disposed of off-site at an approved Contractor-provided disposal site. Excavation outside the excavation limits shown on the plan drawings shall be at no additional expense to the City.

Contaminated Trench Excavation includes the trench excavation of materials characterized as contaminated based on sampling results for the storm sewer, sanitary sewer, and water main construction and in accordance with the trench limits outlined on the plan drawings. This excavated soil shall be managed in accordance with applicable state and federal regulations outlined in the Contract Documents. Handling and disposal of materials shall adhere to all transportation requirements, receive pre-approval from a disposal facility, manifesting, and record keeping, etc., as outlined in the Contractor's Contaminated Soil and Groundwater Handling and Management Plan .

Excavations will require a shoring system to limit the volume of excavation. Excavation outside the trench limits shown on the plan drawings shall be at no additional expense to the City.

7-08.3(1)C Bedding the Pipe

Section 7-08.3(1)C is supplemented with the following:

(*****)

Bedding material shall meet the requirements of Gravel backfill for Pipe Zone Bedding in accordance with Standard Specification Section 9-03.12(3).. Pipe bedding shall be considered incidental to the pipe and no further compensation shall be made.

Pipe bedding material shall be placed to a depth of 6" over and 6" under the exterior walls of the pipe. Hand compaction of the pipe bedding materials under the pipe haunches shall be required. Pipe bedding should provide a firm uniform cradle for support of the pipes. Prior to installation of the pipe, the pipe bedding should be shaped to fit the lower part of the pipe exterior with reasonable closeness to provide uniform support along the pipe. Hand compaction shall be accomplished by using a suitable tamping tool to firmly tamp bedding material under the haunches of the pipe. Care shall be taken to avoid displacement of the pipe during the compaction effort.

In areas where the subgrade soils in the trench excavation consist of fine-grained soils, such as silt/clay, or organic rich soils, the Engineer may direct the Contractor to use a geotextile separator fabric be placed over the native soils prior to placement of the pipe bedding. The geotextile shall meet the requirements of Section 9-33.2(1) Table 3 for Separation. Geotextile shall be paid for by other items.

7-08.3(1)D Pipe Foundation

Section 7-08.3(1)D is a new section:

(*****)

Pipe foundation in poor soil: When soft or unstable material is encountered at the subgrade which, in the opinion of the Engineer, will not uniformly support the pipe, such material shall be excavated to an additional depth as required by the Engineer and backfilled with foundation gravel material placed in maximum 12-inch lifts. Foundation gravel shall conform to the requirements of Section 9-03.17 of the Standard Specifications.

Corrections faulty grade: Excess excavation below grade shall be backfilled with foundation gravel as specified above and thoroughly compacted to the required grade line.

7-08.3(2)A Survey Line and Grade

Section 7-08.3(2)A is replaced with:

(*****)

Survey line and grade control shall be provided in accordance with Sections 1-05.4, 1-05.5 and 1-11 in a manner consistent with accepted practices.

The Contractor shall transfer line and grade into the trench where they shall be carried by means of a laser beam. Any other procedure shall have the written approval of the Engineer.

7-08.3(2)B Pipe Laying – General

Section 7-08.3(2)B is supplemented with the following:

(*****)

Checking of the invert elevation of the pipe may be made by calculations from measurements on the top of the pipe, or by looking for ponding of 1/2" or less, which indicates a satisfactory condition. At manholes, when the downstream pipe(s) is of a larger size, pipe(s) shall be laid by matching the (eight-tenths) flow elevation, unless otherwise approved by the Engineer.

All pipe, fittings, etc. shall be carefully handled and protected against damage, impact shocks, and free fall. All pipe handling equipment shall be acceptable to the Engineer. Pipe shall not be placed directly on rough ground but shall be supported in a manner, which will protect the pipe against injury whenever stored at the trench site or elsewhere. No pipe shall be installed where the lining or coating show defects that may be harmful as determined by the Engineer. Such damaged lining or coating shall be repaired, or a new undamaged pipe shall be furnished and installed.

The Contractor shall inspect each pipe and fitting prior to installation to insure that there are not damaged portions of the pipe. Any defective, damaged, or unsound pipe shall be repaired or replaced. All foreign matter or dirt shall be removed from the interior of the pipe before lowering into position in the trench. Pipe shall be kept clean during and after laying. All openings in the pipeline shall be closed with watertight expandable type sewer plugs at the end of each day's operation, or whenever the pipe openings are left unattended. The use of burlap, wood, or other similar temporary plugs will not be permitted.

Where necessary to raise or lower the pipe due to unforeseen obstructions or other causes, the Engineer may change the alignment and/or the grades. Except for short runs, which may be permitted by the Engineer, pipes shall be laid uphill on grades that exceed 10 percent. Pipe, which is laid on a

downhill grade, shall be blocked and held in place until sufficient support is furnished by the following pipe to prevent movement.

Unless otherwise required, all pipe shall be laid straight between the changes in alignment, and at uniform grade between changes in grade. For concrete pipes with elliptical reinforcement, the pipe shall be placed with the minor axis of the reinforcement in a vertical position.

Immediately after the pipe joints have been made, proper gasket placement shall be checked with a feeler gage as approved by the pipe manufacturer to verify proper gasket placement.

7-08.3(2)E Rubber Gasketed Joints

Section 7-08.3(2)E is supplemented with the following:

(*****)

Care shall be taken by the Contractor to avoid over-inserting the pipe and damaging the pipe or joint system. Any damaged pipe shall be replaced by the Contractor at his expense.

7-08.3(2)H Sewer Line Connections

Section 7-08.3(2)H is supplemented with the following:

(*****)

All connections not occurring at a manhole or catch basin shall be done utilizing pre-manufactured tee connectors or pipe sections approved by the Engineer. Any other method or materials proposed for use in making connections shall be subject to approval by the Engineer.

Unless otherwise approved by the Engineer, all connections of lateral sewers to existing mains shall be as follows:

- | | | |
|----|---------------------|--|
| A. | Vitrified Clay Main | Cut in new PVC "Tee" using "Strong-Back" Flexible Couplings (Fernco or approved equal). |
| B. | Concrete Main | Cut in new PVC "Tee" using "Strong-Back" Flexible Couplings (Fernco or approved equal). |
| C. | PVC & C900 PVC Main | Core-drilled with Romac Saddle (or approved equal) or cut in new "Tee" using "Strong-Back" Flexible Couplings (Fernco or approved equal). |
| D. | Ductile Iron Main | Core-drilled with Romac Saddle (or approved equal). |
| E. | Lined Sewer Main | Connection to sewer mains that have been lined (CIPP, Etc.); cut in new "Tee" using "Strong-Back" Flexible Couplings (Fernco or approved equal). |
| F. | HDPE | Core-Drilled with Romac Saddle. "Inserta-Tee" may be used on sewer mains 12" diameter or larger. |

Connections (unless booted connections have been provided for) to existing concrete manholes shall be per Section 7-05.3(3).

7-08.3(3)A Backfilling Pipe Trenches

Section 7-08.3(3)A is a new section supplementing 7-08.3(3)

(*****)

To the maximum extent available, suitable material obtained from trench or pond excavation shall be used for trench backfill. All material placed as trench backfill shall be free from rocks or stones larger

than 6 inches in their greatest dimension, brush, stumps, logs, roots, debris, and organic or other deleterious materials. No stones or rock shall be placed in the upper three feet of trench backfill. Rock or stones within the allowable size limit incorporated in the remainder of fills shall be distributed so that they do not congregate or interfere with proper compaction.

The existing soils shall not be reused as trench backfill unless otherwise required by the Engineer. Structural fill shall consist of Gravel Borrow, meeting the requirements of Section 9-03.14(1) of the Standard Specifications. It should be free of organics and other debris. The structural trench backfill should be moisture conditioned to within approximately 3 percent of optimum moisture content, placed in loose horizontal lifts less than 6 inches in thickness, and compacted to at least 95 percent of the maximum dry density (MDD) as determined by the Modified Proctor compaction test method ASTM D 1557.

Trench backfill shall be densely compacted in a systematic manner using methods that consistently produce adequate compaction levels. During placement of the initial lifts, the trench backfill material shall not be bulldozed into the trench or dropped directly on the pipe. Heavy vibratory equipment shall not be permitted to operate directly over the pipe until a minimum of 2 feet of backfill has been placed over the pipe bedding.

Contractor shall take special care to obtain good compaction up to the edges of the excavation as the shoring is removed.

The Engineer may be on-site to collect soil samples and to test compaction. The Contractor shall provide site access at all times for compaction testing and sample collection. Areas of the trench which fail to meet the compaction requirements shall be removed and replaced and re-compacted at the Contractor's expense.

The Contractor shall be responsible for any settlement of backfill, sub-base, and pavement that may occur during the period stipulated in the Contract conditions. All repairs necessary due to settlement shall be made by the Contractor at his expense.

Backfill in unimproved areas shall be compacted to at least 90 percent of maximum dry density as determined by the modified proctor compaction test, ASTM D1557.

The Contractor shall be responsible for the disposal of any excess excavated material.

Section 7-08.3(5) Temporary Stormwater Diversion

Section 7-08.3(5) is an added new section

(*****)

It shall be the Contractor's responsibility to maintain operation of the existing storm sewer system throughout the duration of the project without any disruption of service until the new storm drain has been accepted by the City to receive stormwater flows, and connections are made between the existing and new storm based on scheduling approved by the Engineer.

A temporary stormwater diversion shall be capable of bypassing at least the 2-year peak flow during construction.

The Contractor shall submit proposed methods for providing the diversions to the Engineer for approval prior to construction. The diversions shall have the least impact on property owners and traffic flow through the site. The diversions shall be installed, operated, and maintained only when needed where the existing storm drain system must be demolished to allow construction of the new system. Where shown on the Plans, Contractor shall time work of bypasses during period of anticipated no or little rain.

If bypass pumping is provided, it shall be scheduled for continuous operation with backup equipment available at all times for periods of maintenance and refueling or failure of the primary bypass pump(s) or diversion system.

The Contractor shall submit a Temporary Stormwater Diversion Plan in accordance with Section 1-05. The Contractor's plan shall be reviewed by the City before the plan is implemented. The review of the flow diversion plan shall, as well as the Contractor's proposed size of the bypass, in no way relieve the Contractor of his responsibility to provide a bypass system that conveys encountered flows without property damage or damage to the project or construction area. As risk associated with sizing the bypass and impacts to construction is born by the Contractor.

7-08.4 Measurement

Section 7-17.4 is supplemented with the following:

(*****)

Measurement of "Bank Run Gravel for Trench Backfill Sewer" will be determined by the cubic yard in place, measured by the neat line dimensions shown in the Plans, or by the ton on truck tickets.

7-09 PIPE AND FITTINGS FOR WATER MAINS

7-09.3(15)A Ductile Iron Pipe

Section 7-09.3(15) is deleted in its entirety and replaced with the following:

(*****)

Long radius curves with radius of 400 feet or more, either horizontal or vertical, pipe may be laid with standard pipe lengths by deflecting the joints. If the pipe is shown curved on the Plans and no special fittings are shown, the Contractor can assume that the curves can be made by deflecting the joints with standard lengths of pipe. If shorter lengths are required, the Plans will indicate maximum lengths that can be used. The amount of deflection at each pipe joint when pipe is laid on a horizontal or vertical curve shall not exceed 50% of the manufacturer's printed recommended deflections. The Contractor shall submit to the Engineer the pipe manufacturer's joint deflection recommendations prior to pipe installation indicating deflections are within allowable AWWA specification tolerances.

Where field conditions require deflection or curves not anticipated by the Plans, the Engineer will determine the methods to be used. No additional payment will be made for laying pipe on curves as shown on the Plans, or for field changes involving standard lengths of pipe deflected at the joints. When special fittings not shown on the Plans are required to meet field conditions, additional payment will be made for special fittings as provided in Section 1-09.6.

When rubber gasketed pipe is laid on a curve, the pipe shall be jointed in a straight alignment and then deflected to the curved alignment. Trenches shall be made wider on curves for this purpose.

Where pipe installation on curves requires the use of special fittings, concrete blocking shall be used per Section 7-09.3(21).

Where restrained joint pipe is installed on a curve, the Contractor shall submit the pipe manufacturer's recommendations to the Engineer for approval.

7-09.3(15)B Polyvinyl Chloride (PVC) Pipe (4 inches and Over)

Section 7-09.3(15)B is deleted in its entirety and replaced with the following:

(*****)

Polyvinyl Chloride (PVC) Pipe shall not be used for water mains and appurtenances.

7-09.3(17) Laying Ductile Iron Pipe and Fittings with Polyethylene Encasement

The title and text of section 7-09.3(17) has been revised with the following:

(*****)

The Contractor shall lay ductile iron pipe with a polyethylene encasement. Pipe and polyethylene encasement shall be installed in accordance with AWWA C105. The polyethylene encasement shall also be installed on all appurtenances, such as pipe laterals, couplings, fittings, and valves, with 8-mil polyethylene plastic in accordance with Section 4-5 of ANSI 21.5 or AWWA C105.

The polyethylene wrap shall be tube type and black color. Any damage that occurs to the wrap shall be repaired in accordance with ANSI/AWWA C105/A21.5-93.

Installation of the polyethylene encasement shall be considered incidental to the installation of the pipe and no additional payment shall be allowed.

7-09.3(19)A Connections to Existing Mains

Section 7-09.3(19) is revised to read as follows:

(*****)

The Contractor shall not operate any valve on existing Water Main.

The City of Renton Water Operations and Maintenance staff will make all connections to charged water mains and will operate all valves to accomplish shutdowns and subsequent reactivation. The draining of existing water mains will be done by City water maintenance staff. The Contractor shall provide pumping and disposal of the water from the draining of the existing water mains including de-chlorination of the water prior to disposal.

Connections to the existing water main shall not be made without first making the necessary scheduling arrangements with the Engineer in advance. The Contractor shall request water main shut-offs for connections of new water mains to existing water mains at least ten (10) working days in advance for each connection. Approval of connections to existing water main is contingent on the Water Main and appurtenances being completely installed, tested, cleaned with polypig, disinfected and flushed per Contract requirements.

City's water operations and maintenance staff will notify in writing all water customers affected by the shut-offs of the water mains at least 48 hours in advance (not including weekends and holidays) of any water shut-offs. The Contractor may be required to perform the connection during times other than normal working hours. Water main shut-offs shall occur during non-holiday weekdays unless

otherwise specified in the contract documents. Water main shut-offs shall not occur in the five (5) weekdays preceding or the day after the major holidays listed below:

New Year's Day, Martin Luther King Jr. Day, Memorial Day, Independence Day, Labor Day, Veterans Day, Thanksgiving Day, Christmas Day.

Due to the needs of various water customers in the project vicinity, water shut-off periods are limited to the times set forth below:

Days	Hours
Monday to Thursday	9:00 AM TO 3:00 PM
Friday to Sunday	DO NOT SCHEDULE

The City of Renton's Water Maintenance Manager, at his/her sole discretion, may adjust the above shut-off periods in order to address specific project circumstances and customer needs. No water main shutoffs affecting public schools will be allowed during scheduled school hours. The City reserves the right to re-schedule the connection if the work area is not ready at the scheduled time for the connection.

Points of connection to existing water mains shall be exposed by hydro excavation or potholing prior to trenching of the new water mains. Before the installation of the new water mains, the Contractor shall field verify, in the presence of the Engineer, the actual location and depth of the existing water mains where new connections will be made to assure proper fit. Care shall be taken not to disturb existing thrust blocks and soil bearing areas. After excavation, the Contractor shall verify the dimensions, type, condition, and roundness of the exposed water main. The Contractor shall immediately notify the Engineer if the connection cannot be made as specified by the Contract Plans in order that the connection detail may be revised. When necessary, the profile shall be adjusted as directed by the Engineer to prevent abrupt changes in grade and alignment of the water main and connection.

The Contractor shall provide all saw-cutting, removal and disposal of existing surface improvements, excavation, haul and disposal of unsuitable materials, shoring, de-watering, foundation material, at the connection areas before the scheduled time for the connection by the City. The Contractor shall provide all materials necessary for the City Water Maintenance personnel to install all connections to existing water mains as indicated on the contract plans, including fittings, couplings, pipe spools, shackle materials to complete the connections.

The City Water Operations and Maintenance staff will:

- a) Deactivate and dewater the existing and new water main to perform the connections. The Contractor shall provide pumping and disposal of the water from the draining of the water mains including de-chlorination.
- b) Cut, remove and dispose pipe sections as necessary to install the new Materials with Contractor's assistance
- c) Swab all connecting pipe and fittings with 5-6%chlorine solution
- d) Perform the connection work
- e) Reactivate and flush the Water Main

The Contractor shall install the polywrap on all pipe and fittings at the connection points and installed concrete thrust blocks per Contract standard plans and specifications.

In addition to those connections shown on the Plans, segments of a new Water Main may be placed in service prior to completion of the new Water Main. All connection between the charged and uncharged segments of the new Water Main, including connection to a new Tapping Tee and Valve will be done by the City of Renton Water Operations and Maintenance staff.

Connections to existing water mains which include the cutting of the existing water main for the installation of new in-line tee and valves shall be done in two steps:

Step 1: Cut-in of existing water main for installation of in-line tee, valves and appurtenances.

The Contractor shall provide all materials necessary for the City Water Maintenance personnel to cut the existing water main as indicated on the contract plans for the installation of the in-line tee and valves, including but not limited to the required fittings, couplings, pipe spools, shackle materials to complete the cut-in. After the cut-in of the in-line tee and valves by City personnel, the Contractor shall provide and install concrete blocking and polyethylene encasement behind the tee and other fittings. A minimum 3-day curing period is for all concrete blockings before a connection can be made to the new water mains or new tapping valve.

Step 2: Connection of new water main to the above cut-in tee and valves, or to a new tapping valve on existing water mains

7-09.3(21) Concrete Thrust Blocking and Dead-Man Block

Section 7-09.3(21) is deleted in its entirety and replaced with the following:

(*****)

Concrete thrust blocking shall be placed at bends, tees, dead ends, crosses and on other fittings in conformance to the City of Renton Standards Plans, latest revisions and Contract Plans.

Concrete thrust collar and blocking and dead-man thrust blocking shall be installed at locations shown on the plans and shall be in conformance with the Standard Plans and contract Plans. Reinforcement steel shall be Grade 40 or better.

Blocking shall be poured in place Ready-Mix Concrete Class 3000 with a minimum compressive strength at 28 days of 3,000 psi. Job site mixing, hand-mixed concrete and mobile concrete mixers are not allowed.

All fittings to be blocked shall be wrapped with 8-mil polyethylene plastic. Concrete blocking shall bear against solid undisturbed earth at the sides and bottom of the trench excavation and shall be shaped and properly formed with plywood or other acceptable forming materials so as not to obstruct access to the joints of the pipe, bolts or fittings. The forms shall be removed prior to backfilling. Unacceptable concrete blocking shall be replaced at the Contractor's expense.

The Contractor shall provide the Engineer at least 1 Working Day advance notice before pouring concrete thrust blocking and 1 Working Day advance notice for inspection and approval of all concrete blocking prior to backfilling.

7-09.3(23) Hydrostatic Pressure Test

Section 7-09.3(23) is revised to read as follows:

(*****)

Water main and appurtenances including service connections to the meter setter shall be tested in sections of convenient length under a hydrostatic pressure equal to 150 psi in excess of that under which they will operate or in no case shall the test pressure be less than 225 psi at the highest point on the water main. Pumps, gauges, plugs, saddles, corporation stops, miscellaneous hose and piping, and measuring equipment necessary for performing the test shall be furnished and operated by the Contractor.

The Contractor shall obtain a hydrant meter permit from the City by completing a permit application and making the required security deposits. The Contractor shall use the City's issued hydrant meter with an attached backflow prevention assembly to draw water from the City's water system to fill the water mains for poly-pigging, testing, cleaning, disinfection and for subsequent flushing purposes. There will be a charge for the water used for filling, testing, cleaning and disinfection of the water mains.

Sections to be tested shall normally be limited to 1,500 feet or less. The Engineer may require that the first section of pipe, not less than 1,000 feet in length, installed by each of the Contractor's crews, be tested in order to qualify the crew and the materials. Pipe laying shall not be continued more than an additional 1,000 feet until the first section has been tested successfully.

The pipeline shall be backfilled sufficiently to prevent movement of the pipe under pressure. Thrust blocks shall be in place and time allowed for the concrete to cure before testing. Where permanent blocking is not required, the Contractor shall furnish and install temporary blocking and remove it after testing.

Before applying the specified test pressure, the water main shall be slowly filled and air shall be expelled completely from the pipe, valves and hydrants. If permanent air vents are not located at all high points, the contractor shall install corporation cocks at such points so that the air can be expelled as the line is filled with water. After all the air has been expelled, the corporation cocks shall be closed and the test pressure applied. At the conclusion of the pressure test, the corporation cocks shall be removed and plugged.

The Contractor shall perform a leakage test concurrently with the pressure test. The pressure test shall be conducted for a 2-hour period.

The test shall be accomplished by pumping the main up to the required pressure, stopping the pump for 2 hours, and then pumping the main up to the test pressure again. During the test, the section being tested shall be observed to detect any visible leakage.

A clean container shall be used for holding water for pumping up pressure on the main being tested. This makeup water shall be sterilized by the addition of chlorine to a concentration of 50 mg/l.

The acceptability of the pressure test and leakage test will be determined by two factors as follows:

1. The loss in pressure shall not exceed 5 psi during the 2-hour test period.
2. The quantity of water lost from the main and appurtenances shall not exceed the number of gallons during the 2-hour test period as listed in the following table.

Allowable leakage in gallons per 1000 ft. of pipeline* for a 2-hour test period

Test Pressure in psi	Nominal Pipe Diameter in inches							
	4"	6"	8"	10"	12"	16"	20"	24"
400	0.60	0.90	1.20	1.50	1.80	2.40	3.00	3.60
375	0.58	0.87	1.16	1.45	1.74	2.33	2.91	3.49
350	0.56	0.84	1.12	1.40	1.69	2.25	2.81	3.37
275	0.50	0.75	1.00	1.24	1.49	1.99	2.49	2.99
250	0.47	0.71	0.95	1.19	1.42	1.90	2.37	2.85
225	0.45	0.68	0.90	1.13	1.35	1.80	2.25	2.70
200	0.42	0.64	0.85	1.06	1.28	1.70	2.12	2.55

*If the pipeline under test contains sections of various diameters, the allowable leakage will be the sum of the computed leakage for each size. For those diameters or pressures not listed, the formula below shall be used:

The quantity of water lost from the main shall not exceed the number of gallons per hour as determined by the formula:

$$L = \frac{SDVP}{266,400}$$

where:

- L = Allowable leakage in gallons/hour
- S = Gross length of pipe tested, feet
- D = Nominal diameter of the pipe in inches
- P = Test pressure during the leakage test in psi

The quantity of water required to restore the pressure shall be accurately determined by either 1) pumping from an open container of suitable size such that accurate volume measurements can be made by the Engineer or, 2) by pumping through a positive displacement water meter with a sweep unit hand registering one (1) gallon per revolution. The meter shall be approved by the Engineer.

Pressure gauges used in the test shall be accompanied with certifications of accuracy from a testing Laboratory approved by the Engineer.

Any visible leakage detected shall be corrected by the Contractor regardless of the allowable leakage specified above. Should the tested section fail to meet the pressure test successfully as specified, the Contractor shall, at no additional expense to the Contracting Agency, locate and repair the defects and then retest the pipeline.

All tests shall be made with the hydrant auxiliary gate valves open and pressure against the hydrant inlet valve. After the test is completed, each valve shall be tested by closing each in turn and relieving the pressure beyond. This test of the valve will be acceptable if there is no immediate loss of pressure on the gauge when the pressure comes against the valve being checked. The Contractor shall verify that the pressure differential across the valve does not exceed the rated working pressure of the valve.

Prior to calling out the Engineer to witness the pressure test, the Contractor shall have all equipment set up completely ready for operation and shall have successfully performed the test to ensure that the pipe is in satisfactory condition.

Defective materials or workmanship, discovered as a result of hydrostatic field test, shall be replaced by the Contractor at no additional expense to the Contracting Agency. Whenever it is necessary to replace defective material or correct the workmanship, the hydrostatic test shall be re-run at the Contractor's expense until a satisfactory test is obtained.

7-09.3(24)A Flushing and "Poly-pigging"

Section 7-09.3(24)A shall be revised and supplemented with the following:

(*****)

Prior to disinfection and prior to final flushing of the Water Mains for bacteriological sampling and testing, all Water Mains shall first be poly-pigged to remove any solids or contaminated materials that may have entered or become lodged in the pipes during installation.

The "Poly-pig" shall be light density foam (1-2 lbs/cubic-foot) with 90A durometer urethane rubber coating on the rear of the "Poly-pig" only. The "Poly-pig" shall be cylinder shaped with bullet nose or squared end. The "Poly-pigs" shall be inserted in the pipes and retrieved from the pipes through launching stations with vertical crosses and blow-off assemblies as shown and on the Contract Plans and Standard Plans.

If the main cannot be poly-pigged, then a tap shall be provided large enough to develop a flow velocity of at least 2.5 fps in the water main.

Taps required by the Contractor for temporary or permanent release of air, chlorination or flushing purposes shall be provided by the Contractor as part of the construction of water mains.

The Contractor shall be responsible for disposal of treated water flushed from mains and shall neutralize the wastewater for protection of aquatic life in the receiving water before disposal into any natural drainage channel, i.e., receiving water, waters of the State, including wetlands. The Contractor shall be responsible for disposing of disinfecting solution to the satisfaction of the Contracting Agency and local authorities. At a minimum, chlorinated water shall be dechlorinated to a concentration of 0.1 parts per million (ppm) or less, and pH adjustment to within 6.5 – 8.5 standard units before discharging to surface waters of the State or to a storm sewer system that drains to surface waters of the State.

If approved by the Engineer and by the local authority responsible for the sanitary sewer system, disposal of treated water from mains may be made to an available sanitary sewer, provided the rate of disposal will not overload the sewer.

7-09.3(24)D Dry Calcium Hypochlorite

Section 7-09.3(24)D is deleted in its entirety and replaced with the following:

(*****)

Dry calcium hypochlorite shall not be placed in the pipe as laid.

7-09.3(24)K Retention Period

Section 7-09.3(24)K is deleted in its entirety and replaced with the following:

(*****)

Treated water shall be retained in the pipe at least 16 hours but no longer than 48 hours. After the retention period, the chlorine residual shall be tested at all pipe extremities and at other representative points and shall measure at least 10 mg/L. If a measurement of less than 10 mg/L is obtained repeat disinfection is required.

7-09.3(24)N Final Flushing and Testing

Section 7-09.3(24)N is deleted in its entirety and replaced with the following:

(*****)

Following chlorination, treated water shall be flushed from the newly-laid pipe until the replacement water throughout its length shows, upon test, the absence of chlorine. In the event chlorine is normally used in the source of supply, then the tests shall show a residual not in excess of that carried in the water supply system.

A sample tap shall be located ahead of the flushing hose for convenience and for sanitary sampling.

Before placing the lines into service, two satisfactory reports taken at least 15 minutes apart from each sampling point shall be received from the local or State Health Department or from a State accredited testing laboratory on samples collected from representative points in the new system. Samples will be collected and bacteriological tests obtained by the Engineer.

At a minimum, chlorinated water shall be dechlorinated to a concentration of 0.1 parts per million (ppm) or less, and pH adjustment to within 6.5 to 8.5 standard units, if necessary, before discharging to surface waters of the State or to a storm sewer system that drains to surface waters of the State.

7-09.3(25) Joint Restraint Systems

Section 7-09.3(25) is a new section:

(*****)

General:

Where shown in the Plans, in the Specifications or required by the Engineer, joint restraint system (shackle rods) shall be used. All joint restraint materials used shall be those manufactured by Star National Products, 1323 Holly Avenue, PO Box 258, Columbus Ohio 43216, unless an equal alternate is approved in writing by the Engineer.

Materials:

Steel types used shall be:

High strength low-alloy steel (cor-ten), ASTM A242, heat-treated, superstar "SST" series.

High strength low-alloy steel (cor-ten), ASTM A242, superstar "SS" series.

Items to be galvanized are to meet the following requirements:

ASTM A153 for galvanizing iron and steel hardware.

ASTM A123 for galvanizing rolled, pressed and forged steel shapes.

Joint restrainer system components:

Tiebolt: ASTM A242, type 2, zinc plated or hot-dip galvanized. SST 7:5/8" for 2" and 3" mechanical joints, 3/4" for 4" to 12" mechanical joints, ASTM A325, type 3D, except tensile strength of full-body threaded section shall be increased to 40,000 lbs. minimum for 5/8" and 60,000 lbs. minimum for 3/4" by heat treating (quenching and tempering) to manufacturer's reheat and hardness Specifications. SST 753: 3/4" for 14" to 24" mechanical joints. Same ASTM Specification as SST 7. SST 77: 3/4" same as SST 7, except 1" eye for 7/8" rod. Same ASTM Specification as SST 7.

Tienut: Heavy hex nut for each tiebolt: SS8: 5/8" and 3/4", ASTM A563, grade C3, or zinc plated. S8: 5/8" and 3/4", ASTM A563, grade A, zinc plated or hot-dip galvanized.

Tiecoupling: Used to extend continuous threaded rods and are provided with a center stop to aid installation, zinc plated or hot-dip galvanized. SS10: for 5/8" and 3/4" tierods, ASTM A563, grade C3. S10: for 5/8" and 3/4" tierods, ASTM A563, grade A.

Tierod: Continuous threaded rod for cutting to desired lengths, zinc plated or hot-dip galvanized. SS12: 5/8" and 3/4" diameter, ASTM A242, type 2; ANSI B1.1. S12: 5/8" and 3/4" diameter, ASTM A36, A307.

Tiewasher: Round flat washers, zinc plated or hot-dip galvanized. SS17: ASTM A242, F436. S17: ANSI B18.22.1.

Installation:

Install the joint restraint system in accordance with the manufacturer's instructions so all joints are mechanically locked together to prevent joint separation. Tie-bolts shall be installed to pull against the mechanical joint body and not the MJ follower. Torque nuts at 75-90 foot pounds for 3/4" nuts. Install tie-couplings with both rods threaded equal distance into tie-couplings. Arrange tie-rods symmetrically around the pipe.

Pipe Diameter	Number of 3/4" Tie Rods Required
4"	2
6"	2
8"	2
10"	4
12"	4
14"	6
16"	6
18"	8
20"	10
24"	12

Where a manufacturer's mechanical joint valve or fitting is supplied with slots for "T" bolts instead of holes, a flanged valve with a flange by mechanical joint adapter shall be used instead, so as to provide adequate space for locating the tie-bolts.

Where a continuous run of pipe is required to be restrained, no run of restrained pipe shall be greater than 60 feet in length between fittings. Insert long body solid sleeves as required on longer runs to keep tie-rod lengths to the 60 foot maximum. Pipe used in continuously restrained runs shall be mechanical joint pipe and tie-bolts shall be installed as rod guides at each joint.

Where poly wrapping is required all tie-bolts, tie-nuts, tie-couplings, tie-rods, and tie-washers, shall be galvanized. All disturbed sections will be painted, to the Inspector's satisfaction, with Koppers Bitomastic No. 300-m, or approved equal.

Where poly wrapping is not required all tie-bolts, tie-nuts, tie-couplings, tie-rods and tie-washers may be galvanized as specified in the preceding paragraph or plain and painted in the entirety with Koppers Bitumastic No. 800-m, or approved equal.

Tie-bolts, tie-nuts, tie-couplings, tie-rods, and tie-washers shall be considered incidental to installation of the pipe and no additional payment shall be made.

7-09.4 Measurement

Section 7-09.4 is revised with the following:

(*****)

Measurement of bank run gravel for trench backfill will be by the cubic yard measured by the calculation of neat lines based on maximum trench width per Section 2-09.4 or by the ton, in accordance with Section 1-09.

Measurement for payment of concrete thrust blocking and dead-man blocks will be per cubic-yard when these items are included as separate pay items. If not included as separate pay items in the contract, then thrust blocking and dead-man blocks shall be considered incidental to the installation of the water main and no further compensation shall be made.

Measurement for payment for connections to existing water mains will be per each for each connection to existing water main(s) as shown on the Plans.

7-09.5 Payment

Section 7-09.5 is revised and supplemented with the following:

(*****)

"Furnish and Install ____ Ductile Iron Water Main & Fittings", per lineal foot.

The unit contract price per linear foot for each size and kind of "Furnish and Install ____ Ductile Iron Water Main & Fittings" shall be full pay for the bid item as described in Section 1-09.14.

"Concrete Thrust Blocking and Dead-Man Anchor Blocks", per cubic yard.

The unit contract price per cubic yard for "Concrete Concrete Thrust Blocking and Dead-Man Anchor Blocks " shall be full pay for the bid item as described in Section 1-09.14.

"Connection to Existing Water Mains", per each.

The unit contract price per each for "Connection to Existing Water Mains" shall be full pay for the bid item as described in Section 1-09.14.

“Select Imported Trench Backfill”, per cubic yard or ton.

The unit contract price per cubic yard or ton for “Select Imported Trench Backfill” shall be full pay for the bid item as described in Section 1-09.14.

"Removal and Replacement of Unsuitable Foundation Material", per ton or cubic yard.

The unit contract price per cubic yard or ton for "Removal and Replacement of Unsuitable Foundation Material" shall be full pay for the bid item as described in Section 1-09.14.

7-12 VALVES FOR WATER MAINS

7-12.3(1) Installation of Valve Marker Post

Section 7-12.3(1) is deleted in its entirety and replaced with the following:

(*****)

Where required, a valve marker post shall be furnished and installed with each valve. Valve marker posts shall be placed at the edge of the right-of-way opposite the valve and be set with 18 inches of the post exposed above grade.

7-12.3(2) Adjust Existing Valve Box to Grade

Section 7-12.3(2) is a new section:

(*****)

Valve boxes shall be adjusted to grade in the same manner as for manholes, as detailed in Section 7-05.3(1) and the City of Renton Standard Details. Valve box adjustments shall include, but not be limited to, the locations shown on the Plans.

Existing roadway valve boxes shall be adjusted to conform to final finished grades. The final installation shall be made in accordance with the applicable portions of Section 7-12.

In the event that the existing valve box is plugged or blocked with debris, the Contractor shall use whatever means necessary to remove such debris, leaving the valve installation in a fully operable condition.

The valve box shall be set to an elevation tolerance of one-fourth inch (1/4") to one-half inch (1/2") below finished grade.

7-12.4 Measurement

Section 7-12.4 is supplemented with the following:

(*****)

Adjustment of existing valve boxes to grade shall be measured per each, if included as a separate pay item in the Contract; if not a separate pay item but required to complete the Work, then valve box adjustment shall be considered incidental.

Hydrant auxiliary gate valve will be included in the measurement for hydrant assembly and will not be included in this measurement item.

7-12.5 Payment

Section 7-12.5 is deleted in its entirety and replaced with the following:

(*****)

"Furnish and Install ____-Inch Gate Valve Assembly", per each.

The unit contract price per each for "Furnish and Install ____-Inch Gate Valve Assembly" shall be full pay for the bid item as described in Section 1-09.14.

"Air-Release/Air-Vacuum Valve Assembly," per each.

The unit contract price per for air-release/air-vacuum valve assembly shall be for all, labor, equipment and material to complete the installation of the assembly including but not limited to, excavating, tapping the main, laying and jointing the pipe and fittings and appurtenances, backfilling, testing, flushing, and disinfection, meter box and cover, at location shown on the plans, and per the City of Renton Standard Details, latest revision.

"Adjust Existing Valve Box to Grade (RC)," per each.

The contract bid price for "Adjust Existing Valve Box to Grade" above shall be full compensation for all labor, material, tools and equipment necessary to satisfactorily complete the Work as defined in the Contract Documents, including all incidental Work. If not included as a separate pay item in the Contract, but required to complete other Work in the Contract, then adjustment of valve boxes shall be considered incidental to other items of Work and no further compensation shall be made.

7-14 HYDRANTS

7-14.3(1) Setting Hydrants

Section 7-14.3(1) is deleted in its entirety and replaced with the following:

(*****)

Where shown on the Plans, hydrants shall be installed in accordance with the Standard Plans and Contract specifications. A minimum 3-foot radius unobstructed working area shall be provided around all hydrants. The bottom surface of the breakaway flange shall be set 2-inches minimum and 7-inches maximum above the concrete shear block finished grade.

For each hydrant requiring vertical adjustment, see Section 7-14.3(6).

Fire hydrants shall be of such length as to be suitable for installation with connections to 6", 8" and 10" piping in trenches 3 - 1/2 feet deep unless otherwise specified. The hydrant shall be designed for a 4-1/2 foot burial where 12" and larger pipe is shown unless otherwise noted in the Plans.

After installation hydrants shall be subjected to a hydrostatic test as specified in Section 7-09.3(23).

The hydrant excavation shall be backfilled and compacted when installation and testing are complete and accepted by the Engineer.

A concrete shear block as shown by the hydrant details on the Standard Plans shall be constructed for all hydrants. Construction, Materials, and finishing of the concrete shear block shall conform to

Section 8-14, Cement Concrete Sidewalk. The shear block shall be set flush with the immediately surrounding finish grade.

The Contractor shall flush, test and disinfect furnished hydrants and hydrant barrel extensions according to Section 7-14.3(6).

Upon completion of the project, all fire hydrants shall be painted with two field coats of Kelly-Moore/Preservative paint No. 5780-563 DTM Acrylic Gloss Safety Yellow or approved equal.

Any hydrants not in service shall be identified by covering with a burlap or plastic bag properly secured.

Fire hydrant assembly shall include: main line cast-iron or ductile iron tee (MJ x FL), 6" gate valve (FL x MJ), 6" DI spool (PE x PE) up to 18 feet in length, 5-1/4" MVO fire hydrant (MJ connection), 4" x 5" Storz adapter with stainless steel cable, cast iron valve box, cover, valve operating nut extension, 2-3/4" Cor-Ten shackle rods and accessories, concrete blocks, shear block and blue pavement marker.

7-14.3(3) Resetting Existing Hydrants

Section 7-14.3(3) is supplemented with the following:

(*****)

All existing hydrants to be reset shall be rebuilt to the approval of the Engineer. All rubber gaskets shall be replaced with new gaskets of the type required for a new installation of the same type.

Unless a specific bid item has been included in the Proposal/Contract Document, resetting existing hydrants shall be incidental to and included in the various bid items.

7-14.3(4) Moving Existing Hydrants

Section 7-14.3(4) is supplemented with the following:

(*****)

All existing hydrants to be moved shall be rebuilt to the approval of the Engineer. All rubber gaskets shall be replaced with new gaskets of the type required for a new installation of the same type.

Unless a specific bid item has been included in the Proposal/Contract Document, resetting existing hydrants shall be incidental to and included in the various bid items.

Unless a specific bid item has been included in the Proposal/Contract Document, resetting existing hydrants shall be incidental to and included in the various bid items.

7-14.3(7) Remove and Salvage Hydrant

Section 7-14.3(7) is a new section:

(*****)

Existing hydrants shall be removed where shown in the Plans. Removed hydrants shall be delivered to the City of Renton shops by the Contractor. The existing hydrant lateral tee shall be removed from the main.

Unless a specific bid item has been included in the Proposal/Contract Document, resetting existing hydrants shall be incidental to and included in the various bid items.

7-14.5 Payment

Section 7-14.5 is revised with the following:

(*****)

Payment will be made in accordance with Section 1-04.1, for each of the following bid items that are included in the proposal:

“Furnish and Install Hydrant Assembly”, per each.

The unit contract price per each for "Furnish and Install Hydrant Assembly", shall be full pay for the bid item as described in Section 1-09.14.

“Resetting Existing Hydrants”, per each.

The unit contract price per each for “Resetting Existing Hydrant” shall be full pay for all Work to reset the existing hydrant, including rebuilding (or replacement with a new hydrant), shackling, blocking, painting, and guard posts and reconnecting to the main. The new pipe connecting the hydrant to the main shall be considered incidental and no additional payment shall be made. Guard posts, shown on the Plans shall be incidental to the contract.

“Moving Existing Hydrants”, per each.

The unit contract price per each for “Moving Existing Hydrant” shall be full pay for all Work to move the existing hydrant, including new tee, rebuilding (or replacement with a new hydrant), shackling, blocking, painting, and guard posts and reconnecting to the main. The new pipe connecting the hydrant to the main shall be considered incidental and no additional payment shall be made. Guard posts, shown on the Plans shall be incidental to the contract.

7-15 SERVICE CONNECTIONS

7-15.3 Construction Details

Section 7-15.3 is supplemented with the following:

(*****)

All pipe materials for new water service lines and for extension or replacement of existing water service lines shall be copper and lead free in accordance with the Federal Reduction of Lead in Drinking Water Act. Pipe materials for water service line installation for size 2-inch or less and connection to ductile iron water main shall be copper type “K” annealed tubing and seamless (ANSI H33.1).

Ductile iron pipe Class 52 or stronger shall be direct-tapped with 1-inch corporation stops for 1-inch service lines.

All meter setters for residential domestic use shall be 1-inch by 1-inch setters unless otherwise specified on the Contract Plans. For existing 3/4-inch meters, the Contractor shall furnish and install reducing couplings to adapt the 1-inch setter to the standard 3/4-inch domestic meter.

Where installation of service lines is within existing paved streets, the service lines shall be installed by a trenchless percussion and impact method (hoe-hogging). If the trenchless percussion and impact method fails, regular open trench methods may be used.

Where shown in the Plans, the Contractor shall:

- Furnish and install new water service lines from the new water main to the new meter setters and new meter boxes near the existing meters
- Furnish and install adaptors for the relocation of the existing water meters to the new meter setters and re-install the existing meters in the new meter setters
- Connect the new meter setters to the customers' private service lines
- Restore disturbed areas to their approximate original condition as directed by the Engineer.

7-15.5 Payment

Section 7-15.5 deleted in its entirety and replaced with the following:

(*****)

Payment will be made in accordance with Section 1-04.1, for the following bid item when it is included in the proposal:

"Furnish and Install ____ In. Water Service Connection", per each.

The unit contract price per each for "Furnish and Install ____ In. Water Service Connection", shall be full pay for the bid item as described in Section 1-09.14.

7-17 SANITARY SEWERS

7-17.2 Materials

Section 7-17.2 is deleted in its entirety and replaced with the following:

(*****)

Pipe

Gravity sewer pipe shall be as specified herein and as shown on the Plans. The Contractor shall provide electronic copies of the pipe manufacturer's technical literature and tables of dimensional tolerances to the Engineer. Any pipe found to have dimensional tolerances in excess of those prescribed or having defects, which prevent adequate joint seal or any other damage, shall be rejected. If requested by the Engineer, not less than three nor more than five lengths of pipe for each size, selected from stock by the Engineer, shall be tested as specified for maximum dimensional tolerance of the respective pipe.

Materials shall meet the requirements of the following sections:

Material for sewer pipe shall meet the requirements of Section 9-05.12 as modified in these special provisions or as specified on the project plans.

(Specification to list acceptable materials and applicable specification for project).

All pipe shall be clearly marked with type, class, and thickness. Lettering shall be legible and permanent under normal conditions of handling and storage.

7-17.3 Construction Requirements

7-17.3(1) Protection of Existing Sewerage Facilities

Section 7-17.3(1) is supplemented with the following:

(*****)

When extending an existing sewer, the downstream system shall be protected from construction debris by placing a screen or trap in the first existing manhole downstream of the connection. It shall be the Contractor's responsibility to maintain this screen or trap during construction of the new sewer and then remove it once the new system is placed into service. The Contractor shall remove any construction debris that enters the existing downstream system as a result of his work at his expense. When the first manhole is set, its outlet shall be plugged until acceptance of the new construction by the Engineer.

7-17.3(2)H Television Inspection

Section 7-17.3(2)H is supplemented with the following:

(*****)

CCTV Inspection

1. All newly-installed and newly-rehabilitated (public and private) Sanitary Sewer and Storm Drain main lines shall be inspected by means of remote CCTV. CCTV inspections and reports shall be submitted to the City of Renton inspector assigned to the project prior to receiving approval to install project curbs, gutters and/or pavement.
2. The Contractor shall perform all CCTV inspections in accordance with the National Association of Sewer Service Companies (NASSCO) Pipeline Assessment Certification Program (PACP).
3. All CCTV operators shall have current NASSCO PACP certification.
4. CCTV inspections shall be recorded in a GraniteNet compatible format database using the latest software version and submitted with electronic links between the data and the video on an External HDD, DVD or Flash Drive.
5. All CCTV inspection reports shall be within +/- two (2) feet of the measured linear footage between manholes along the existing pipeline centerline from the start of pipe to end of pipe.
6. All Owner and PACP required header information must be fully and accurately entered on all CCTV reports. Work not following these specifications will be rejected and the Contractor shall be required to re-CCTV the work.
7. The documentation of the work shall consist of PACP CCTV Reports, PACP database, logs, electronic reports, etc. noting important features encountered during the inspection. The speed of travel shall be slow enough to inspect each pipe joint, tee connection, structural deterioration, infiltration and inflow sources, and deposits, but should not, at any time, be faster than 30 feet per minute, except as noted otherwise in this document.
8. The camera must be centered in the pipe to provide accurate distance measurements to provide locations of features in the sewer and these footage measurements shall be displayed and documented on the video. All PACP Observations shall be identified by audio and on a PACP log. All video must be continuously metered from manhole to manhole. All video recording shall be continuous from structure to structure with no "pausing" of the video recording during each pipeline inspection. The pipe shall be cleaned prior to the CCTV inspection to ensure all defects, features and observations are seen and logged.
9. Just prior to beginning the CCTV inspection, while the CCTV camera is in place and recording, water (containing dye) shall be introduced into the upstream manhole of each

pipe segment until it is observed and recorded flowing past the camera's field of vision in its entirety.

10. The CCTV camera shall have a water-level measuring device (ball, cylinder, etc.) attached that has ¼" markings to show the depth of water in the pipe during the CCTV inspection.
11. All manholes shall be channeled and coated prior to CCTV inspection.
12. Per City of Renton specification 7-08.3(2)B, sewer and storm drain pipeline shall have no more than ½" of ponding to be considered acceptable.

7-17.3(2)I Abandon Existing Sanitary Sewer Pipes

Section 7-17.3(2)I is a new section:

(*****)

Where it is shown on the plans that existing sanitary sewer pipe(s) is to be abandoned by filling with grout, both ends of the abandoned pipe and all lateral connections to the pipe shall be plugged with 3,000 psi cement concrete and the pipe shall be filled with cement-based grout.

The grout mix design and method of installation shall be approved by the Engineer prior to beginning the operation (See Section 9-03.22 for Grout Mix requirements).

7-17.5 Payment

Section 7-17.5 is revised and supplemented with the following:

(*****)

Payment will be made in accordance with Section 1-04.19, for each of the bid items that are included in the proposal.

The unit contract price per linear foot for "Testing Sewer Pipe" shall be full pay for all labor, material and equipment required to conduct the leakage tests required in Section 7-17.3(2). If no unit price for "Testing Sewer Pipe" is included it shall be considered incidental to the pipe items.

7-18 SIDE SEWERS

7-18.3(2) Fittings

Section 7-18.3 is deleted in its entirety and replaced with the following:

(*****)

Fittings and connections to new and existing sewers shall be per the City of Renton's Standard Plans.

7-18.3(3) Testing

Section 7-18.3(3) is deleted in its entirety and replaced with the following:

(*****)

All side sewers constructed in conjunction with a new sewer main shall, for purposes of testing as specified in Section 7-17, have the side sewer cleanout at the right-of-way (as shown in the respective City of Renton Standard Plans) installed prior to testing. Caps shall be installed and sufficiently restrained on the end of each side sewer and its respective surface cleanout to withstand the internal pressure created for testing in conjunction with the sewer main.

Where a sewer main and its respective side sewer are constructed to replace an existing, in-operation sewer system, pressure testing will not be required.

7-18.3(5) End Pipe Marker

Section 7-18.3(5) is deleted in its entirety and replaced with the following:

(*****)

The location of side sewers at the property line shall be indicated by the presents of a surface cleanout installed per the associated City of Renton Standard Plan.

7-19 SEWER CLEANOUTS

7-19.3 Construction Requirements

Section 7-19.3 is deleted in its entirety and replaced with the following:

(*****)

Sewer cleanouts shall be installed per the associated City of Renton Standard Plan(s).

7-19.4 Measurement

Section 7-19.4 is deleted in its entirety and replaced with the following:

(*****)

Sewer cleanouts that are installed on sewer main lines will be measured per each.

Sewer cleanouts that are installed on side sewers shall be considered incidental to the side sewer pipe.

7-20 CURED IN PLACE PIPE (CIPP)

Section 7-20 is a New Section.

Description

This Section specifies rehabilitation of existing wastewater or stormwater (host pipes) by the installation of felt or fiberglass resin-impregnated liner cured-in-place piping (CIPP). Service connections and manholes may be rehabilitated with products specified in other Sections. Contractor shall coordinate rehabilitation of manholes, mainlines, and lateral interfaces with product installers. Contractor shall ensure that resin systems are compatible with all rehabilitation products that they will contact. Work to remove and replace manhole cones, risers, frame and cover, and concrete collars necessary for the installation of the CIPP shall be considered incidental as part of the CIPP Work.

Licensing

The Contractor or sub-contractors shall have a current City of Renton business license.

The Contractor or sub-contractor installing the CIPP shall have a current license agreement with the product Manufacturer.

All individuals installing the CIPP shall be certified by the product Manufacturer.

Certification showing that the Installer is currently licensed by the appropriate licensor to perform CIPP installation shall be submitted in accordance with Section 1-07.6.

Contractor and Manufacturer Qualifications

Manufacturer Qualifications:

- The Manufacturer's CIPP liner shall have successfully installed a minimum of 200,000 linear feet in accordance with these specifications.
- Manufacturers using standards other than those listed in these specifications shall demonstrate, to the satisfaction of the Owner, that their standards produce a product that is, at a minimum, equal to the quality of a product produced using these specifications.

Contractor Qualifications:

- A minimum of five (5) successful projects totaling a minimum of 50,000 linear feet of installed CIPP meeting the requirements of these specifications
- The Contractor's superintendent shall have a minimum of three (3) successfully completed projects totaling a minimum of 25,000 linear feet of installed CIPP meeting the requirements of these specifications. The superintendent shall be onsite during installation of the CIPP work for the duration of the project.
- At least one (1) person on the Contractor's installation crew shall have a minimum of one (1) year of CIPP installation experience. This person shall be onsite at all times during the CIPP installation work.
- The Contractor's identified Lateral Cutting Technician shall have a minimum of one (1) year of experience reinstating laterals.

Contractor Submittals

All procedures or material descriptions requiring the Engineer's approval shall be submitted not less than 15 calendar days prior to mobilizing or commencing any CIPP activities at the site of the work. Submit as specified in Section 6-07.3(2). The following submittals are required:

1. CIPP Lining Plan to include the following:
 - a. Work sequence organized by pipe section with installation schedule.
 - b. Confirmation of liner length and diameter.
 - c. Locations of all service connections with disposition for each.
 - d. Anticipated cleaning and preparation requirements.
 - e. Proposed lining material and curing method.
 - f. Sewer Service Interruption Notification Plan.
2. Spill Prevention Plan.
3. Manufacturer's certificate(s) indicating that the supplied lining materials meet the requirements of the specifications, ASTM standards, and a certificate of compliance from an independent third-party lab.
4. Certification stating CIPP tube has been manufactured in accordance with ASTM F1216 or F2019 and resin is suitable for its intended use.
5. Certification showing the Contractor is currently licensed by the appropriate licenser to perform CIPP installation.
6. Name of resin supplier and liner fabric supplier.
7. Test reports on testing of CIPP products illustrating they meet the relevant requirements of this specification. Manufacturer shall provide ISO 9001 certificate by a third party confirming that all the ASTM test reports are valid and up to date at the time of the bid and during construction period.
8. Manufacturer's recommendations for factory and field (whichever applies) wet out procedures including: volume of resin per unit of liner, mixing ratios and procedures for

resin and catalyst/hardener, shelf life of resin, pot life of resin, required wet out procedure to ensure full saturation, and other criteria deemed necessary to ensure proper wet out of the liner.

9. Manufacturer's data sheets for factory wet out and/or Contractor's data sheets for field wet out showing quantity of resin and catalyst used for each length of liner, at or prior to time of installation.
10. Manufacturer's certification that all Manufacturer's wet out recommendations have been followed on all lengths of CIPP which have factory wet out, at or prior to time of installation.
11. Manufacturer's recommendations for storage procedures and temperature control, handling and inserting the liner, curing details, service connection methods, trimming and finishing, QA/QC procedures, and minimum equipment requirements to allow for an adequate installation.
12. Manufacturer's recommendations and procedures for minimum and maximum pressures, temperatures, and time durations to be used.
13. Data on Contractor's equipment to be used on site including: type and tolerance of temperature gages and thermocouples used to monitor cure temperature; type and tolerance of equipment used to generate liner inversion pressure; make, model, and technical data of all equipment used to generate heat for the curing process; make, model and technical data of backup equipment used to maintain curing temperature; rough size of vehicle(s) which carries the CIPP pipe and overall installation equipment footprint required.
14. Contractor shall calculate and submit to the Engineer for review after field verification of pipe sizes and prior to ordering any material from the manufacturer the required minimum thickness for the CIPP to be installed in each pipe reach based on the internal inspection data.
15. Manufacturer onsite Representative's Certification that the Contractor's installation meets all requirements of the Manufacturer and will not void the Owner's warranty.
16. CIPP field samples from field installations. Field sampling procedure shall be in accordance with the latest version of ASTM F1216 or F2019 or ASTM F1743 and in accordance with ASTM D5813.
17. Material Safety Data Sheets for resins, hardeners, catalysts, solvents, and all other compounds or chemicals to be used on the job site.
18. Data logger output in a graphic format showing pipe section, time, pressure, and temperature during activation, heating, curing, and cool down, as applicable for CIPP technology used.
19. Informational hand out that describes the materials, processes, and odors associated with the lining process. This handout shall be provided at the request of residents.
20. Pre- and Post-Installation CCTV inspection videos.
21. Contractor shall obtain a Discharge Authorization Permit from King County's Wastewater Treatment Division for any proposed discharges to the existing Sanitary Sewer System, including process water resulting from the curing process (if applicable). Contractor is responsible for adhering to all discharge limitations associated with the received permit. Contractor shall submit a copy of the permit to the City once obtained.

Warranty

Contractor shall provide a 1-year written bonded warranty for the full value of the contract with a 3.5 percent inflation allowed per year after acceptance of the liner to cover the repairs resulting

from liner failure within the warranty period, including new pipe, labor and incidentals as well as any fines by the local, state, and federal environmental agencies.

The written bonded warranty shall be issued by a BB+ rated surety with more than 20 years of business history and with headquarters in the United States.

Product Storage and Handling Requirements

Contractor shall be responsible for the delivery, storage, and handling of all materials for CIPP and end sealing material in accordance with the written requirements of the manufacturer.

Contractor shall exercise adequate care during transportation, handling, and installation to ensure the CIPP material is not torn, cut, or otherwise damaged. If any part or parts of the CIPP material becomes torn, cut, or otherwise damaged before or during insertion, it shall be repaired or replaced in accordance with the manufacturer’s recommendations and approval of the Engineer before proceeding.

Materials

CIPP products and materials shall be in accordance with the latest version of ASTM F1216 for Resin-Impregnated Flexible Tube (Felt Liner) or ASTM F2019 for Glass Reinforced Plastic (GRP) Thermosetting Resin Pipe (Fiberglass Liner), with Suppliers recommendations as described below.

CIPP

The CIPP design shall be in accordance with the latest version of ASTM F2019, with physical properties and chemical resistance demonstrated per ASTM D5813, F2019 for Type III, Grade 2 CIPP classification, with final approval from the Engineer. The liner thickness shall be designed based on the engineering formulas listed in ASTM F1216 and F2019 for “fully deteriorated” pipes and the conditions indicated below:

1. Design Safety Factor = 2.0.
2. Ovality factor = 2 percent.
3. Constrained Soil Modulus = Per ASTM D3839, Soil Class III at 90 percent compaction.
4. Modulus of soil reaction, $E' = 700$ psi.
5. Groundwater Depth = At ground surface.
6. Soil Depth = As indicated on the drawings.
7. Live load using an AASHTO HS20 vehicle loading.
8. Soil Unit Weight = 140 lbs/cf.
9. Minimum Service Life = 50 years.

Felt Cured-in-Place Resin Impregnated Material

The liner shall be designed in accordance with the procedures of ASTM F1216. All material properties used in design calculations shall be long-term (time-corrected) values.

The design for the CIPP shall recognize any non-uniform cross section and the liner bifurcation present at the spring line of the host pipe. Accounting for this condition by the use of an ovality reduction factor alone is unacceptable.

The CIPP will be continuous in length and the wall thickness shall be uniform. No overlapping sections shall be allowed throughout the circumference or the length of the liner.

The CIPP will be capable of conforming to offset joints, bells, and disfigured pipe sections. It shall be able to stretch to fit irregular pipe sections and negotiate bends as shown on the drawings. The CIPP service life shall be a minimum of 50 years.

The Contractor shall be responsible for control of all material and process variables to provide a finish CIPP possessing the minimum properties specified in ASTM F1216.

The CIPP shall be marked at a distance of regular intervals along its entire length, not to exceed five (5) feet. Markings shall include Manufacturer's name or identifying symbol.

The CIPP liner shall be manufactured with materials from a consistent supplier. All materials of similar type shall be from a single source for the entire project. The CIPP shall be fabricated to a size that, when installed, will tightly fit the internal circumference and length of the original pipe. Allowance shall be made for circumferential and longitudinal stretching during the installation process. Diametric shrinking during the curing process shall meet the requirements of ASTM D5813, Section 6.3.1 or better.

For liners inserted by the inversion method, the CIPP shall be coated on one side with a translucent waterproof coating of polyvinyl chloride (PVC) or polyurethane.

For liners inserted by the pull/winch method, the CIPP shall be coated on one side with a translucent waterproof coating of PVC, polyurethane, polyethylene, or polypropylene.

Fiberglass Cured-in-Place Resin Impregnated Material

Glass Reinforced Plastic Flexible Tube (fiberglass liner), consists of at least two separate tubes of corrosion resistant glass fiber in accordance with ASTM D5780 and F2019. Liner shall include an inner foil (or calibration hose) to contain resin which shall be removed after completion of installation (unless intended to be a permanent part of the CIPP system and fabricated as an integral part of the tube by bonding or fusing). In addition, an external permanent foil shall be provided that is resistant and impermeable to moisture and all wave lengths of light as part of the UV curing process.

The liner shall be continuous in length and the wall thickness shall be uniform. No overlapping sections shall be allowed throughout the circumference or length of the liner.

The liner shall be capable of conforming to offset joints, bells, and disfigured pipe sections. It shall be able to stretch to fit irregular pipe sections and negotiate bends as shown on the drawings.

The liner shall be marked at regular intervals along its entire length, not to exceed five (5) feet. Markings shall include Supplier's name or identifying symbol.

The liner shall be manufactured with materials from a consistent supplier. All materials of a similar type shall be from a single source for the entire project.

The liner shall be fabricated to a size that, when installed, will tightly fit to the internal, circumference and length of the host pipe. Allowance shall be made for circumferential stretching during the installation process.

The liner shall not be of a dark or non-reflective material which would inhibit proper closed-circuit television inspection.

The liner shall meet the chemical resistance criteria specified in ASTM D5813, D578 and ASTM F2019 (Appendix X2) for Type III, Grade 2.

The liner shall be handled with care during delivery to protect from UV exposure prior to installation.

Resin & Cured CIPP Properties

The resin used shall be compatible with the CIPP system used, and designed for use depending on the application. The resin shall be a general purpose, unsaturated polyester, catalyst system compatible with the CIPP system that provides the cured physical strengths and properties specified herein. Resins shall be tinted for adequate visibility suitable for internal inspection and provide positive indication of adequate liner wet-out.

The resin system for the cure-in-place pipe process, using steam or water curing, shall be manufactured in accordance with ASTM F1216. Resin shall have the following characteristics:

1. The resin shall be thermosetting polyester.
2. When cured, the resin shall have a flexural strength of not less than 4,500 psi (ASTM D790).
3. When cured, the resin shall have a flexural modulus (short term) of not less than 250,000 psi (ASTM D790).
4. When cured, the resin shall have a tensile strength of not less than 3,000 psi (ASTM D338).
5. 50-year flexural creep modulus: 150,000 psi per ASTM D 2990.
6. Tensile strength: 9,000 psi per ASTM D638 for sectional liner. For materials that do not allow sufficiently accurate hoop/weft testing in accordance with ASTM D638, initial tensile strength may also be substantiated by short-term flat plate specimen testing.
7. The resin shall be able to cure in the presence of water.
8. The resin initiation temperature for curing should be as recommended by manufacturer.
9. The resin color shall be in contrast to the color of the liner fabric to assist in visual inspection.
10. The CIPP resin shall be compatible with the liner fabric, liner coating, other rehabilitation systems and the host pipe materials that it may contact.
11. The resin shall form no excessive bubbling or wrinkling during lining.
12. The resin shall be manufactured with materials from a consistent supplier. All materials of similar type shall be from a single source for the entire project.
13. The resin shall have no fillers added for the sole purpose of increasing the resin volume. Resin shall include no more than five (5) percent filler by volume for the purpose of modifying resin viscosity, heat transfer characteristics, or flexural modulus of a cured liner.

The resin system for the cure-in-place pipe process using ultraviolet curing shall be manufactured in accordance with ASTM F2019. Resin shall have the following characteristics:

1. The resin shall be chemically resistant polyester thermoset and catalyst system compatible with UV curing installation process. A photo-inhibitor system shall be added to the resin prior to impregnation. The initiator system of the resin shall be optimized to the output of the ultraviolet curing lights.
2. When cured, the resin shall have a flexural strength of not less than 6,500 psi (ASTM D790).
3. When cured, the resin shall have a flexural modulus (short term) of not less than 725,000 psi (ASTM D790).

4. When cured, the resin shall have a tensile strength of not less than 9,000 psi (ASTM D3039, D368).
5. 50-year flexural creep modulus: 150,000 psi per ASTM D 2990.
6. Tensile strength: 9,000 psi per ASTM D 638 for sectional liner. For materials that do not allow sufficiently accurate hoop/weft testing in accordance with ASTM D638, initial tensile strength may also be substantiated by short-term flat plate specimen testing.
7. The resin color shall be in contrast to the color of the liner fabric to assist in visual inspection.
8. The CIPP resin shall be compatible with the liner fabric, foils and host pipe materials.
9. The resin shall form no excessive bubbling or wrinkling during lining.
10. The resin shall be manufactured with materials from a consistent supplier. All materials of similar type shall be from a single source for the entire project.
11. The resin shall have no fillers added for the sole purpose of increasing the resin volume. Resin shall include no more than five (5) percent filler by volume for the purpose of modifying viscosity, heat transfer characteristics, or flexural modulus of a cured liner.

Dimensions of CIPP

Contractor shall measure the actual inside diameter of the host pipe, at different locations along its length, to verify the appropriate size of CIPP liner to use. The existing host pipe may be larger than their nominal size due to corrosion of the concrete pipe. It is the Contractor's responsibility to measure the actual inside diameter at different locations of the host pipe to verify the appropriate size of the CIPP liner to use.

The Contractor shall make allowances in determining the felt tube length and circumference for stretch during installation and shrinkage during curing and aging. The minimum length shall be that which continuously spans the distance from the center of the inlet manhole to the center of the outlet manhole, based on the specifics of the repair and pipe diameter. The Contractor shall verify the lengths in the field before the liner tube is cut and impregnated. Individual installation runs may include one or more manhole-to-manhole sections as authorized by the Engineer.

Wall Thickness

The wall thickness of the tube shall be ordered to the next standard incremental thickness above the minimum calculated design thickness. Unless otherwise specified to provide for excess resin migration, the gap thickness of the wetting out equipment shall be sized to allow an excess of 5 to 10 percent resin to pass during impregnation.

The nominal CIPP thickness shall be at least the calculated design thickness, per ASTM F1216 (felt liner) or F2019, (fiberglass liner) except where fabric layers overlap, in which case it may be in excess of this value.

CIPP Liner Labeling

Manufacturer label on each liner tube shall be in 1-inch letters, minimum, and include the following information:

1. Date of manufacture of the liner.
2. Name or trademark of the manufacturer.
3. Liner diameter.
4. Liner thickness.
5. Liner length.

Chemical Resistance

The cured pipe shall be resistant to a variety of chemical effluents as described in ASTM D543. Testing for chemical resistance may be performed on the sample of the finished product prior to this contract, provided a certified affidavit, signed by an officer of the company, is submitted stating the resin the tests apply to and the resin submitted for this project are the same. Testing data up to 2-years prior to bid date will be accepted. Finished and cured CIPP liner properties shall perform as specified.

Chemical resistance test results shall be provided in accordance with Test Method D543 on samples of the cured liner material that are the same as that proposed for installation. Exposure should be for a minimum of one month at 73.4 degrees F. During this period, the CIPP test specimens should lose no more than 20 percent of their initial flexural strength and flexural modulus when tested in accordance with Section 8 of ASTM F1216, when subjected to the following solutions:

Chemical Solution	Concentration, percent
Tap Water (pH 6-9)	100
Nitric Acid	5
Phosphoric Acid	10
Sulfuric Acid	10
Gasoline	100
Vegetable Oil	100
Detergent	0.1
Soap	0.1

The Contractor shall be responsible for all costs associated with the chemical resistance tests. Proof of meeting the requirements for the design specified shall be provided to the Engineer for approval at least seven (7) days prior to ordering any material.

CIPP End and Connection Seal

Contractor shall seal the end points of the liner so that no leakage of fluids may infiltrate between the liner and the existing pipe. Contractor shall apply epoxy sealant (after CIPP acceptance) to completely seal area around opening of the liner and the connection. Hydraulic cements and quick-set cement products are not acceptable. The installation of the connection seal shall not, in any way, damage or adversely affect the CIPP. If damage to the CIPP liner does occur, the Contractor shall repair or replace the area at no additional cost to the Owner. Contractor shall trim loose or hanging/intruding pipe connection seals so that they are flush with the internal pipe wall. The Contractor shall not fold the hanging/intruding material.

Allowable CIPP and End Connection Seal Manufacturers

The following manufacturers of CIPP are approved:

1. Inliner Technologies.
2. Insituform Technologies, Inc.
3. National Liner.
4. Premier-Pipe.
5. Spiniello Companies.
6. SAK, LLC.

7. Saertex.
8. Reline America Inc.
9. Or approved equal.

The following manufacturers of CIPP end and connection sealing are approved:

1. Neopoxy.
2. Or approved equal.

Construction Requirements

Pre-Installation CCTV Inspection

Contractor shall conduct CCTV video inspection of the host pipe prior to commencing construction. All CCTV inspections shall be performed in accordance with Section 7-17.3(2)H.

Contractor will review the CCTV inspection and indicate where the following deficiencies are located:

1. Any obstructions within the host pipe that may affect the sliplining operation.
2. Joint separation.
3. Offset joint.
4. Cracked or damaged host pipe.
5. Out of round host pipe.
6. Infiltration point.

The findings of the pre installation inspection shall be summarized in an inspection report and submitted along with the video files and corresponding database to the Engineer for review.

Flow Management

It shall be the Contractor's responsibility to maintain operation of the existing sewer and/or storm systems throughout the duration of the project. The Contractor shall divert all flows around each segment of the pipe designated for rehabilitation. This diversion shall consist of redirecting flow from an upstream manhole and discharging it to a manhole downstream of the rehabilitation operation. This can be accomplished via a combination of pumping and/or gravity flow. After the work is completed, flow shall be returned to the rehabilitated sewer and/or storm system. The area affected by the bypass operation shall be fully restored to pre-bypassing conditions.

Bypass pumping system of stormwater shall be capable of bypassing at least the 2-year peak flow during construction.

Bypass pumping shall be scheduled for continuous operation. Back-up equipment shall be on-site and available for periods of maintenance, refueling or failure of the primary bypass pump(s) or diversion system. Bypass pumping shall be done in such a manner as not to damage private or public property, or create a nuisance or public menace. The bypass-pumping pipe shall not block any driveways or intersections unless approved by the Engineer. The sewage shall be pumped through a watertight hose or pipe that is adequately protected from traffic. The discharge of raw sewage to private property, city streets, sidewalks, storm sewer, or any location other than an approved sanitary sewer is prohibited. The Contractor shall be liable for all cleanup, damages, and resultant fines should the Contractor's operation cause any backups or overflows.

The Contractor's bypass operation shall be sized to handle, at a minimum, the full pipe capacity in each subject line removed from service. If flow conditions are greater than full pipe, the Contractor may elect to wait for flow conditions to subside prior to removing the subject line from service. Working days will not be charged for the period of time during which the flow is greater than full pipe. No additional payment will be made for periods of high flows during which the Contractor elects to wait for lower flows. Once the Contractor removes a section of line from service he/she is responsible to bypass any and all flow in the system during construction, even in the event the system surcharges and exceeds the full pipe capacity, until the line is returned to service.

All bypassing systems shall be approved by the Engineer. The Contractor shall submit a plan for bypassing the existing system to the Engineer for review. The Contractor's plan for bypass pumping shall be satisfactory to the Engineer before the Contractor will be allowed to commence bypass pumping. The sewage and/or storm bypass pumping plan shall include an emergency response plan detailing procedures to be taken in the event of a failure of the bypass pumping. The review of the bypassing system and equipment by the Engineer shall in no way relieve the Contractor of their responsibility and public liability.

The Contractor shall coordinate activities with impacted property owners. Property Owners shall be notified at least 24 hours in advance of any disruption to their sewer service. All construction-related service disruptions shall be approved by the Engineer prior to the disruption taking place.

When situations exist where impacted properties cannot be disconnected, plugged, or subjected to any other service interruption, i.e., hospitals, care facilities, restaurants, etc., bypass pumping of the side sewer to the downstream sanitary sewer system shall be required prior to insertion of the liner system. The Contractor shall verify, with the approval of the Engineer, whether a property is able to be interrupted prior to lining operations. If the subject property's side sewer requires bypass pumping, the costs for the bypass pumping shall be covered by Force Account.

Host Pipe Access

Contractor shall install access structures necessary for installation of CIPP liner. Access structures to the host pipe for installation of the CIPP liner shall be excavated as required by the Contractor. Access structures shall be located in areas that minimize excavation requirements. Provide excavation and backfill, pipe work, reconnection, and access structures including manhole cones, risers, frame and cover, and concrete collars as necessary. The Contractor shall plug the downstream manhole to prevent excavation material from entering the sewer and/or storm system during the installation of all access structures.

Prior to entering any permit-required confined space, the Contractor shall evaluate the atmosphere to determine the presence of toxic, flammable vapors or lack of oxygen in accordance with local, state, and federal safety regulations.

Host Pipe Cleaning, Preparation, and Inspection

Prior to CIPP tube installation, the Contractor shall clean the host pipe. The Contractor shall clear the existing host pipe of obstructions such as solids, collapsed pipe, roots, rocks or other intrusions that will prevent or hinder CIPP liner installation. Minimize infiltration into the existing pipe so as not to interfere with the proper installation and cure of the CIPP liner.

The Contractor shall perform pre-lining inspection after cleaning and preparation to confirm that the host pipe is ready for lining. The pre-lining inspection video shall be submitted to the Engineer for review at least 24 hours prior to the scheduled installation of the liner. Installation of the liner shall not proceed prior to receiving approval by the Engineer. The Engineer will confirm the following:

1. Necessary cleaning and pipe preparation work, including any internal and external repairs/modifications have been completed.
2. That the condition of the host pipe is consistent with the design conditions and specifications. Prior to commencing lining, the Contractor shall notify the Engineer of any condition that is contrary to the design conditions or assumptions made that may affect either long term or short term performance or the liner.
3. The location, condition, and operational status of all lateral tap connections.

At each location within the Project, prior to diversion of flows the Contractor shall initiate odor control measures.

The Contractor shall perform post-lining CCTV inspection following installation of the liner. The Contractor shall confirm the adequacy of all lateral tap connection reinstatements and the fit and the finish of the CIPP liner prior to submitting the post-installation inspection video files to the Engineer.

The Contractor shall submit CCTV post-installation inspection reports and video files along with the corresponding data base to Engineer within one (1) week of the inspection.

Point Repairs

The Contractor shall advise the Engineer of any point repairs that can only be performed by excavating the defect.

The Contractor shall repair all defects in the host pipe including but not limited to open joints, fractures, cracks, protruding taps and holes in the pipe that may adversely affect the successful installation of the liner. Those repairs shall include, but not limited to, the following:

1. Grouting all defects as recommended by liner manufacturer or installer.
2. Grouting all locations with excessive infiltration as outlined below:
 - a. The determination of an excessive leak shall be made by the Owner's representative and shall be based on PACP leak designations:
 - i. Leaks that would be categorized as a Runner(IR) – Severity 4 or Gusher (IG) – Severity 5 shall be considered as excessive. Measurement and Payment for Excessive Leak Repairs shall be as designated in Section 7-20.6 and 7-20.7.
 - ii. Leaks categorized as Weeper(IW) – Severity 2 or Dripper(ID) – Severity 3 shall be considered incidental to the unit price for CIPP rehabilitation. Measurement and Payment for Excessive Leak Repairs shall be as designated in Section 7-20.6 and 7-20.7.
3. Make point repairs of any host pipe defect that be accomplished using conventional sewer cleaning equipment or by remotely performed repair methods acceptable to the Engineer such as grout packers, link seal, or spot liner. Remove protruding laterals, rolled gaskets, roots, mineral deposits, and other objects protruding into the host pipe utilizing a remote-controlled cutter.

Trimming Intruding Laterals

Contractor shall trim intruding laterals so that the service connection is flush with the internal pipe wall. All lateral trimming shall be documented by pre and post trimming photos. The Contractor shall ensure that the existing pipe is not damaged during cutting operations.

Protection of Existing Manholes

The Contractor shall protect all manholes from any damage that may result from the lining operation.

Spill Prevention and Control

Contractor shall keep a stockpile of spill cleanup materials, such as rags or absorbents, readily accessible on-site.

Contractor shall immediately contain and prevent leaks and spills from entering storm drainage systems, and properly clean up and dispose of all waste and cleanup materials. If the waste is hazardous, the Contractor shall dispose of hazardous waste only at authorized and permitted disposal facilities. Only licensed hazardous waste haulers shall transport the hazardous waste to an off-site location, unless the quantities to be transported are below those applicable threshold limits for transportation by the Contractor as specified under State and Federal regulations.

Contractor shall immediately report any hazardous materials spill to the Owner and Engineer.

Installation

Felt Liner CIPP Tube Installation

Lining installation shall be in accordance with the requirements of the product Manufacturer and as directed by their Technical Representative. This includes the correction of defective work.

Contractor shall designate the location where the CIPP tube will be impregnated with resin ("wet-out"). These locations shall be subject to approval by the Engineer. The Contractor shall allow the Engineer to inspect the materials and "wet-out" procedure. If the "wet-out" location is not at the project site, the impregnated CIPP tube shall be transported to site under controlled environmental conditions as specified by the Manufacturer of the product. Transport vehicles shall include a tamper resistant, sealed temperature recording device which records the temperature of the liner at all times after leaving the wet-out site. Contractor shall decide when to transport the resin impregnated CIPP tube and when to commence installation depending on prevailing weather conditions, so as to not jeopardize the installation or be detrimental to the long-term performance of the CIPP.

The liner shall be installed by the inversion tube method where possible. The resin-impregnated tube shall be lowered into the insertion pit through an inversion tube and reducer if needed. The liner shall be installed at a rate less than 10 feet per minute at all times. The CIPP liner shall be installed through existing manholes. Liner shall not be installed through intermediate manholes unless approved in advance by the Engineer. All requests to line through intermediate manholes shall be submitted in writing to the Engineer.

There shall be no separate payment for additional or enhanced access to facilitate the Contractor's CIPP liner installation process.

For CIPP liner thicknesses greater than 0.75 inch, or where the existing pipe, soil, and groundwater is likely to provide a significant heat sink affecting the temperature gradient across the CIPP liner material, the temperature of the exotherm shall be monitored by remote temperature sensors placed at the interface of the existing pipe and the CIPP. A minimum of two temperature sensors shall be installed, one at either end of the length being lined. The curing process shall not be terminated until the temperature sensor readings indicated that a satisfactory cure has been completed. Any extended cure times shall not adversely affect the properties of the CIPP lining material.

The curing process shall follow a step cure using steam, where possible, as recommended by the manufacturer and approved by the Engineer. The curing process shall be held at the top step for an adequate length of time to ensure that the design physical properties of the liner are attained. For the water curing method, circulation water shall cool down to at least 100 degrees F for 1 hour before releasing the hydrostatic head. The rate of temperature rise and fall during heating and cooling shall not exceed 2 degrees F per minute. The circulation water shall be filtered through a carbon filter treatment system, approved by the Engineer, prior to release into the sanitary sewer system. Evacuate water from the pipe at a controlled rate to prevent negative pressure in the pipe. The Contractor shall provide a sampling plan to the Engineer that demonstrates pollutants are not being discharged into the sanitary sewer system.

After liner has cooled down, perform a preliminary television inspection of the newly installed liner. Verify the liner is continuous over the entire length. Verify the liner is free from visual defects such as foreign inclusions, dry spots, lifts, pinholes, seam separation, delamination, and wrinkling beyond the specification allowances. Liner shall be impervious and free of any leakage. Wrinkles in the finished CIPP, that create a void between the wrinkle and the pipe which reduce the structural integrity of the CIPP, and which adversely decreases the hydraulic capacity of the pipe, or cause a backwater of one (1) inch, are unacceptable and shall be removed and repaired at no additional cost to the Owner.

After the curing is complete and verified, all existing active service connections, as determined by the Engineer, shall be reinstated. Reinstall all service laterals using only remote internal methods. Where the CIPP liner does not create dimples at the service connections or in other ways indicate the locations, the exact location shall be determined from the internal inspection data. It shall be the Contractor's responsibility to accurately locate and reinstall all service connections after the CIPP installation and curing has been completed. All service connections shall be reinstated to a minimum of 95 percent of the original opening, matching the invert of the lateral.

Fiberglass Liner CIPP Tube Installation

Liner installation shall be in accordance with the requirements of the product Manufacturer and as directed by their Technical Representative. This includes the correction of defective work.

Resin Impregnation: The wet out procedure for flexible fiberglass tube liner impregnation shall conform to the following requirements:

1. Furnish glass reinforced plastic tube liner (fiberglass liner) per this specification.
2. Impregnate the flexible fiberglass tube liner with resin under controlled conditions at the manufacturer's plant.
3. Use a volume of resin sufficient to fill all voids in the liner material at nominal thickness and diameter. Volume shall be adjusted by adding 5 to 10 percent excess resin for the

change in resin volume due to polymerization and to allow for any migration of resin into the cracks and joints of the host pipe. Keep logs of resin volume actually used in the wet out process and submit to Engineer prior to installation.

4. The impregnated liner shall be stored, transported, and installed in accordance with the manufacturer's recommendations and in such a manner that it will not be damaged, exposed to direct sunlight, exposed to any curing environment, or result in a public safety hazard. All materials may be subject to inspection and review by the Engineer prior to installation.

Liner installation shaft conform to the following requirements:

1. Sliding Foil and Winch Cable — upon verification of removal of debris and protrusions, pull in sliding foil as recommended by the manufacturer.
2. Pulling Head or Pulling Manifold and Inverted Roller — Connect liner to the winch cable forming a pulling head or using a pulling manifold. Care shall be taken in mounting a pulling manifold to provide an airtight fit. The rate of the pulling head or manifold shall not exceed the maximum rate recommended by the Manufacturer and in accordance with ASTM F2019.
3. Pull resin impregnated fiberglass liner into position using a power winch. The pulling speed shall not exceed the maximum rate recommended by the Manufacturer. If product is sensitive to elongation, measure overall elongation of the fiberglass liner after the pull-in completion. The acceptable longitudinal elongation shall be less than two (2) percent of the overall length specified by the manufacturer.
4. The fiberglass liner shall be inflated with air until it is fitting tight against the wall of the existing host pipe. The air pressure shall be adjusted to hold the impregnated fiberglass liner in place during the curing process.

Ultraviolet Light Curing:

1. Curing process shall conform with ASTM F2019.
2. Assemble multi-lamp ultraviolet light curing assembly (UV curing assembly) according to Manufacturer's recommendations for the pipe and liner diameter. Ultraviolet (UV) curing lights shall be tuned or optimized to the photo initiator system of the resin. Provide quantity and strength of UV lamps per manufacturer's recommendation. UV lamps shall not exceed 80 percent of logged hours of usage of the manufacturer's stated usage rate. UV curing assembly shall have minimum of one CCTV camera and sensors to record temperature and pressure during curing process.
3. While maintaining sufficient air pressure to inflate the impregnated fiberglass liner, insert multi-lamp ultraviolet light curing assembly (UV curing assembly) in order with UV curing bulbs OFF to draw the curing mechanism through the impregnated liner and perform a pre-curing inspection. Upon confirmation that the liner is ready for curing, turn on UV curing bulbs and conduct curing process. Unless approved by Engineer, do not pull UV light train in a downstream direction during the curing process.
4. UV curing assembly shall travel through the impregnated fiberglass liner at a pre-determined speed to allow polymerization of the resin as recommended by the manufacturer.
5. The Contractor shall follow the Supplier's cool-down instructions prior to relieving the air pressure of the liner.

6. The Contractor shall document a UV curing report and submit a file copy to the Engineer for each pipe. This sheet shall contain, but not be limited to, the following:
 - a. Date of Installation.
 - b. Site number(s) and address.
 - c. The curing method used (i.e. UV).
 - d. Time and rate of travel for UV curing process.
 - e. Pressure and temperature readings.
 - f. Amount of lamps in operation on UV curing assembly.
 - g. Time of installation from start to finish.

Testing

Post Installation CCTV Inspections

Contractor will review the CCTV inspection video tapes and indicate where the following deficiencies are located:

1. Cracked or damaged liner pipe.
2. Out of round liner pipe.
3. Debris in liner pipe.

The findings of the post installation inspections shall be summarized in inspection reports and submitted to the Engineer for review. Final acceptance of the installation will not take place until any deficiencies identified in the inspections are addressed.

Material Testing

Contractor shall prepare a sample of the installed CIPP liner for subsequent testing of its physical properties. Sampling shall be performed for each separate installation of CIPP or one (1) test per batch-order of sectional liner. The Owner reserves the right to take five (5) random core samples of the installed CIPP liner at no additional cost in accordance with the procedures in ASTM D5813, as is applicable. The method of repair will be as recommended by the Contractor.

The minimum wall thickness shall be determined at a minimum of three locations on a cut section of the CIPP lining using a method of measurement accurate to the nearest 0.005 inch or one (1) test per batch order of sectional liner not taken from actual live installation.

The sample shall be prepared using the flat plate sampling method in accordance with the procedures in ASTM F1216. The flat plate sample shall be large enough to provide five sample specimens each for short-term flexural (bending) properties, as per ASTM D790. The sample will be clamped in a mold and placed in the downtube during the curing of the CIPP tube. The sample shall be removed after all the water is removed from the cured pipe tube. The samples shall be identified by Date, Project Name, Size, Thickness, Location, Resin, and Catalyst. The cured sample shall be tested by an independent testing laboratory as recommended by the CIPP liner manufacturer and approved by the Engineer for the short-term flexural (bending) properties and tensile properties, per ASTM D790 and ASTM D638, respectively. The sample shall be double bagged and sealed.

The Contractor shall provide liner test results for long-term properties in accordance with ASTM D 2990. The Contractor shall be responsible for any deviation from the specified physical properties and those evaluated through testing. Failure to meet the specified physical properties

shall result in the CIPP liner being considered defective Work and shall be rejected. The Contractor shall be responsible for all costs associated with the testing of the liner physical properties.

For UV-Cured Systems — Contractor shall provide an additional restrained field sample to allow circumferential (hoop) directions of the fiberglass reinforcement, at least 2-inches wide (axial direction of the liner, along the length) to test a representative amount of fibers if glass roving mats are used. The samples are to be tested in a curved beam configuration where the minimum beam width is 2-inches, in accordance with ASTM F2019.

Cleanup

Following inspection, the Contractor shall clean up the entire Project area. All excess material and debris, not incorporated into the permanent installation, shall be disposed off site by the Contractor at a site approved by the Engineer.

Measurement

Measurement for “X-Inch CIPP Pipe” will be linear feet installed. Linear feet installed shall be measured along the invert. The number of linear feet will be measured from the center of manhole to center of manhole.

Measurement for “Lateral Reinstatement” will be per each.

Measurement for “Excessive Leak Repair” will be per each.

Payment

Payment Schedule for “X-Inch CIPP Pipe”, “Lateral Reinstatement”, and “Excessive Leak Repair” is shown in Section 1-09.14.

7-21

8-02 ROADSIDE RESTORATION

8-02.3(4)A Topsoil Type A

Section 8-02.3(4)A is supplemented with the following:

(*****)

The contractor shall provide a material submittal for topsoil prior to use.

8-02.3(16)A Lawn Installation

Section 8-02.3(16)A has been supplemented with the following:

(*****)

8-02.3(16)A1 Submittals

8-02.3(16)A1a Certification of Material

1. Include seed mix percentages, purity, germination rates, weed experience, and date tested for the preceding. Include complete data on source, size and quality.
2. Supply on-site 12” x 12” sample of each sod specified for inspection and approval in advance by the City.

3. Supply Grower's written recommendations for fertilizer type, rate of application, and frequency.
4. All certificates required by law shall accompany shipments.
5. Upon completion of the installation and prior to final inspection, deliver all certificates to the Engineer.

8-02.3(16)A1b Manufacturer's Certificates of Conformance

1. Supply for Certificates of Conformance for fertilizer being used for the project.

8-02.3(16)A1c Schedule for Installation

1. The Contractor shall coordinate all work with the City and submit a watering plan for the Establishment Period.

8-02.3(16)A2 Product Handling

Deliver all items to the site in their original containers, with all labels intact and legible, at the time of the City's inspection. Coordinate delivery and installation of sod to ensure sod is installed immediately upon delivery.

Use all means necessary to protect new lawn areas before, during, and after installation and to protect the installed work and materials of all other trades.

In the event of damage or rejection, immediately make all repairs and replacements necessary for the approval of the Inspector and at no additional cost to the City.

8-02.3(16)A3 Site Information

If sod is stored onsite, preserve and protect all sod on site prior to and during installation. Protect from wind, drought, unusual weather and vandalism. Store all sod on site within limits of work.

Protect adjacent property, public walks, curbs and pavement from damage. Do not block public access routes with plant material.

8-02.3(16)A4 Sod

The Contractor shall provide sod to all new lawn areas and to those lawn areas requiring restoration from the Contractor's operations. Sod shall conform to section 9-14.6(8) as shown in the Special Provisions.

8-02.3(16)A4a Other Materials

All other materials not specifically described but required for a complete and proper planting installation, shall be selected by the Contractor subject to the approval of the Engineer.

8-02.3(16)A5 Execution

Prior to all work of this section, carefully inspect the installed work of all other trades and verify that all such work is complete to the point where this installation may properly commence. Verify that lawn installation may be completed in accordance with the original design and the referenced standards. In the event of discrepancy, immediately notify the Engineer for specific instructions.

8-02.3(16)A5a Installation Preparation

1. Prepare subgrade in all lawn areas by scarifying to a 8” minimum depth and removing rocks and debris over 1” in diameter. Subgrade soils should be free-draining and without any impervious soils or other materials harmful to plant growth. Notify the Inspector of any subgrade conditions deleterious to plant growth.
2. Spread topsoil to a minimum depth of 6” after settlement in all lawn areas.
3. Thoroughly rototill topsoil to a minimum depth of 6 inches.
4. Fine grade per Contract Specifications in turf areas as indicated on drawings. Rake entire surface to conform to site grading. Grade edges to 1” below adjacent paved surfaces to provide a smooth transition. Roll as necessary to firm grade to satisfaction of the Inspector.
5. Apply fertilizer to the prepared lawn areas at rates recommended by sod grower and lightly rake to incorporate into the soil.

8-02.3(16)A5b Sod Installation

1. Moisten sod bed and roll lightly for compaction.
2. Lay sod strips per supplier’s instructions. Tightly butt joints, trim edges to conform to smooth curves and straight lines of pavement. Sod is to be flush with paved surfaces after settlement. Avoid gaps and overlaps and stagger sod joints in a brick-like fashion.
3. Remove any bumps, undulations, or low-high spots with a light rolling.
4. Water daily for a minimum of two weeks to prevent dehydration.
5. Protect all turf areas by erecting temporary fences, barriers, signs, etc. as necessary to prevent trampling.
6. Do not work in, over, or adjacent to planting areas without proper protection and safeguards.

8-02.3(16)B Lawn Establishment

Section 8-02.3(16)B has been deleted and replaced with the following:

(*****)

8-02.3(16)B Lawn Establishment and Final Acceptance

The Contractor shall maintain all new lawn areas in this project; shall be responsible for the survival of turf in acceptable condition and shall maintain all new lawn areas in a neat and orderly fashion until Final Acceptance of the project by the City. The period for Final Acceptance shall be no sooner than the second mowing. The Contractor will be held responsible for all damage or loss caused by his inattention or carelessness. The Contractor shall repair damage caused by traffic, vandalism, weather or other outside causes.

8-02.3(16)B1 Establishment Period

The Establishment Period will commence on the date of Preliminary Acceptance and will extend to Substantial Completion or Final Acceptance by the City of landscape work, whichever is later. Maintenance during this period will include:

1. Watering: Water areas of new turf so they receive adequate water for survival of the plant in a healthy position.
2. Lawns shall be fertilized every six weeks from March through September per Grower’s written recommendations. Lawns shall be maintained weed-free.
3. Lawns are to be mowed weekly or as needed to maintain a neat appearance. All grass clippings shall be removed from the site. Maximum height of lawn shall not exceed three inches.

4. Protect all lawn areas against damage, including erosion and trespassing, by providing and maintaining proper safeguards.
5. Debris Control: Debris control shall be accomplished in all landscaped lawn areas on a regular basis, at least weekly or more often where necessary. This will include leaf fall control in Fall period. Policing for paper and litter in all areas shall be conducted at least weekly. During the Fall period leaves, windblown into gutters and catch basins, are considered as litter and shall be removed as debris.

8-02.3(16)B2 Guarantee

All new turf areas shall be guaranteed by the Contractor to be in a healthy condition for a period of one year from the date of Final Acceptance.

8-02.3(16)B3 Final Acceptance

Acceptance of lawn planting as specified shall be based on a uniform stand of grass and a uniform grade at the time of final inspection.

Final inspection of the work of the Section will be made at the time of the Final Inspection of the entire project or earlier, if approved by the Engineer. A final punch list will be issued. Final Acceptance of the new turf areas which are the responsibility of the Contractor will be contingent upon Final Acceptance of the entire project or at the determination of the City if earlier than Final Acceptance of the entire project.

8-09 RAISED PAVEMENT MARKERS

8-09.5 Payment

Section 8-09.5 has been revised with the following:

(*****)

Payment will be made for each of the following bid items that are included in the proposal:

“Raised Pavement Marker Type 1”, per each.

“Raised Pavement Marker Type 2”, per each.

“Raised Pavement Marker Type 3-_____ In.”, per each.

“Recessed Pavement Marker”, per each.

The unit contract price per each for “Raised Pavement Marker Type 1”, “Raised Pavement Marker Type 2”, and “Raised Pavement Marker Type 3-_____ In.” and “Recessed Pavement Marker” shall be full pay for all labor, materials, and equipment necessary for furnishing and installing the markers in accordance with these Specifications, including all cost involved with traffic control unless traffic control is listed in the Contract as a separate pay item.

8-13 MONUMENT CASES

8-13.1 Description

Section 8-13.1 is revised and supplemented with the following:

(*****)

This Work shall consist of furnishing and placing monument cases and covers, in accordance with the Standard Plans and these Specifications, in conformity with the lines and locations shown in the Plans or as staked by the Engineer or by the Contractor supplied Surveyor.

8-13.3 Construction Requirements

Paragraphs 2 and 3 of Section 8-13.3 is revised and supplemented with the following:

(*****)

The monument will be furnished and set by the Contractor supplied Surveyor.

When existing monuments will be impacted by a project, the Contractor shall be responsible for assuring that a registered surveyor references the existing monuments prior to construction. After construction is complete, the monuments shall be re-established by the Surveyor in accordance with RCW58.09.130.

8-13.4 Measurement

Section 8-13.4 is supplemented with the following:

(*****)

All costs for surveying and resetting existing monuments impacted by construction shall be considered incidental to the Contract unless specifically called out to be paid as a bid item.

8-13.5 Payment

Section 8-13.5 is supplemented with the following:

(*****)

"Reset Existing Monument" per each.

Resetting an existing monument impacted by construction shall be incidental unless included as a pay item in the Schedule of Prices.

8-14 CEMENT CONCRETE SIDEWALKS

8-14.3(4) Curing

Section 8-14.3(4) is replaced with:

(*****)

The curing materials and procedures outlined in Section 5-05.3(13) of the Standard Specifications shall prevail, except that white pigmented curing compound shall not be used on sidewalks. The curing agent shall be applied immediately after brushing and be maintained for a period of 5 days.

The Contractor shall have readily available sufficient protective covering, such as waterproof paper or plastic membrane, to cover the pour of an entire day in the event of rain or other unsuitable weather. During the curing period, all traffic, both pedestrian and vehicular, shall be excluded. Vehicular traffic shall be excluded for such additional time as the Engineer may specify.

The Contractor shall be responsible for barricading, patrolling, or otherwise protecting the newly placed concrete to prevent damage. Damaged, vandalized, discolored, stained, or unsightly concrete shall be removed and replaced at the expense of the Contractor.

8-14.4 Measurement

Section 8-14.4 is supplemented by adding the following:

(*****)

When the Contract contains a pay item for "Curb Ramp, Cement Concrete," the per each measurement shall include all costs for the complete installation per the Plans and standard details including expansion joint material, curb and gutter and ramped sidewalk section. Sawcutting, removal and disposal of excavated materials including existing pavement and sidewalk, crushed surfacing base materials and all other Work, materials and equipment required per Section 8-14, shall be included in the per each price for "Curb Ramp, Cement Concrete" unless any of these other items are listed and specified to be paid as separate pay items.

If the Contract does not provide a pay item for "Curb Ramp, Cement Concrete," but the Plans call for such installation, then quantities shall be measured with and paid for under the bid items for Curb and Gutter and for Cement Concrete Sidewalk. When curb ramps are to be constructed of asphalt concrete, the payment shall be included in the pay item for "Miscellaneous and/or Driveway Asphalt Concrete."

8-14.5 Payment

Section 8-14.5 is supplemented with the following:

(*****)

"Curb Ramp, Cement Concrete," per each.

Payment for excavation of material not related to the construction of the sidewalk but necessary before the sidewalk can be placed, when and if shown in the Plans, will be made in accordance with the provisions of Section 2-03. Otherwise, the Contractor shall make all excavations including haul and disposal, regardless of the depth required for constructing the sidewalk to the lines and grades shown, and shall include all costs thereof in the unit contract price per square yard for "Cement Concrete Sidewalk" and the per each contract price for "Curb Ramp, Cement Concrete."

8-17 IMPACT ATTENUATOR SYSTEMS

8-17.5 Payment

Section 8-17.5 is supplemented with the following:

(*****)

If no pay item is included for temporary impact attenuators then all costs to provide and install shall be considered a part of the pay item for "Traffic Control."

8-20 ILLUMINATION, TRAFFIC SIGNAL SYSTEMS, AND ELECTRICAL

8-20.2(1) Equipment List and Drawings

(*****)

Paragraph four of Section 8-20.2(1) is revised and supplemented with the following:

The Contractor shall submit for approval six sets of shop drawings for each of the following types of standards called for on this project:

1. Light standards with or without pre-approved Plans.
2. Signal standards with or without pre-approved Plans.
3. Combination Signal and lighting standards.
4. Metal Strain Poles.

Paragraph five of Section 8-20.2(1) is deleted.

Paragraph six of Section 8-20.2(1) is deleted.

Section 8-20.2(1) is supplemented with the following:

The Contractor also shall submit either on the signal standard shop drawings or attached to the signal standard shop drawings all dimensions to clearly show the specific mast arm mounting height and signal tenon locations for each signal pole to be installed.

8-22 PAVEMENT MARKING

8-22.1 Description

The following item in Section 8-22.1 is revised with the following:

(*****)

Crosswalk Stripe

A SOLID WHITE line, 8 inches wide and 10-feet long, installed parallel to another crosswalk stripe and parallel to the direction of traffic flow and centered in pairs on lane lines and the center of lanes. See detail sheet.

Skip Center Line (Replacement)

A BROKEN YELLOW line 4 inches wide. The broken or "skip" pattern shall be based on a 24-foot unit consisting of a 9-foot line and a 15-foot gap. Skip center strip is used as centerline delineation on two-lane or three-lane, two-way highways.

Double Yellow Center Line (Replacement)

Two SOLID YELLOW lines, each 4 inches wide, separated by a 4-inch space. Double yellow center stripe is used as centerline delineation on multilane, two-way highways and for channelization.

Approach Line (New)

A SOLID WHITE line, 8 inches wide, used to separate left and right turning movements from through movements, to separate high occupancy vehicle lanes from general-purpose lanes, for islands, hash marks, and other applications. Hash mark stripes shall be placed on 45-degree angle and 10 feet apart.

Lane Line (Replacement)

A BROKEN WHITE line, 4 inches wide, used to delineate adjacent lanes traveling in the same direction. The broken or "skip" pattern shall be based on a 24-foot unit consisting of a 9-foot line and a 15-foot gap.

Two Way Left Turn Line (Replacement)

A SOLID YELLOW line, 4 inches wide, with a BROKEN YELLOW line, 4 inches wide, separated by a 4-inch space. The broken or "skip" pattern shall be based on a 24-foot unit consisting of a 9-foot line and a 15-foot space. The solid line shall be installed to the right of the broken line in the direction of travel.

Crosswalk Line (Replacement)

A SOLID WHITE line, 8 inches wide and 10 feet long, installed parallel to another crosswalk stripe and parallel to the direction of traffic flow and centered in pairs on lane lines and the center of lanes. See detail sheet.

Stop Line (Replacement)

A SOLID WHITE line 12, 18, or 24 inches wide as noted on the Contract Plans.

8-22.3(5) Installation Instructions

Section 8-22.3(5) is revised with the following:

(*****)

A manufacturer's technical representative need not be present at the initial material installation to approve the installation procedure.

8-22.5 Payment

Section 8-22.5 is supplemented with the following:

(*****)

"Approach Stripe," per linear foot.

"Remove Paint Line" wide," per linear foot.*

"Remove Plastic Line" Wide," per linear foot.*

"Remove existing traffic markings, "per Lump Sum.*

*The linear foot contract price for "Remove Paint Line" and "Remove Plastic Line" and the lump sum contract price for "Remove existing traffic markings" shall be full compensation for furnishing all labor, tools, material, and equipment necessary for removal of existing traffic markings as per the Plans, Specifications and detail sheets. If these pay items do not appear in the contract schedule of prices, then the removal of old or conflicting traffic markings required to complete the channelization of the project as shown on the Plans or detail sheets shall be considered incidental to other items in the Contract and no further compensation shall be made.

8-23 TEMPORARY PAVEMENT MARKINGS

8-23.5 Payment

Section 8-23.5 is supplemented with the following:

(*****)

If no pay item is included in the Contract for installation, or for removal of temporary pavement markings, then all costs associated with these items are considered incidental to other items in the Contract or included under "Traffic Control," if that item is included as a bid item.

9-03.8(7) HMA Tolerances and Adjustments

Item 1 is deleted and replaced with:

(*****)

1. **Job Mix Formula Tolerances.** After the JMF is determined as required in 5-04.3(7)A, the constituents of the mixture at the time of acceptance shall conform to the following tolerances:

	Nonstatistical Evaluation	Commercial Evaluation
Aggregate, percent passing		
1", ¾", ½", and 3/8" sieves	±6%	±8%
U.S. No. 4 sieve	±6%	±8%
U.S. No. 8 sieve	±6%	±8%
U.S. No. 16 sieve	±4%	±6%
U.S. No. 30 sieve	±4%	±6%
U.S. No. 50 sieve	±4%	±6%
U.S. No. 100 sieve	±3%	±5%
U.S. No. 200 sieve	±2.0%	±3.0%
Asphalt Binder	±0.5%	±0.7%
VMA	1.5% below minimum value in 9-03.8(2)	
VFA	minimum and maximum as listed in 9-03.8(2)	
Va	2.5% minimum and 5.5% maximum	

These tolerance limits constitute the allowable limits as described in Section 1-06.2. The tolerance limit for aggregate shall not exceed the limits of the control point's section, except the tolerance limits for sieves designated as 100% passing will be 99-100.

9-03.22 Cement-based Grout for Abandoning Existing Utilities (Additional Section)

Section 9-03.22 is a new section:

(*****)

The Contractor shall submit a mix proposal that has flow characteristics appropriate for filling a utility pipeline. The mix proposal for "Cement-base Grout for Abandoning Existing Utilities" shall be approved by the Engineer prior to commencing work on this item.

Cement-based Grout for Abandoning Existing Utilities shall be equal to a 1-sack mix and the materials shall conform to the following:

Cement: This material shall be Portland cement as specified in section 9-01.

Aggregate: This material shall meet the requirements for fine aggregate as specified in Section 9-03.1.

Water: Water shall conform to the provisions of Section 9-25.1.

Minimum Strength: 100 psi

9-05 DRAINAGE STRUCTURES, CULVERTS, AND CONDUITS

9-05.4 Steel Culvert Pipe and Pipe Arch (RC)

Section 9-05.4 is revised with the following:

(*****)

Steel culvert pipe and pipe arch shall meet the requirements of AASHTO M 36, Type I and Type II. Welded seam aluminum coated (aluminized) corrugated steel pipe and pipe arch with metallized coating applied inside and out following welding is acceptable and shall be asphalt treatment coated.

9-05.7(2) Reinforced Concrete Storm Sewer Pipe (RC)

Section 9-05.7(2) is replaced by the following:

(*****)

Reinforced Concrete Storm Sewer pipe shall conform to the requirements of ASTM C-76 and shall be Class IV. Cement used in the manufacture of reinforced concrete pipe shall be Type II in conformance with ASTM C150. No admixture shall be used unless otherwise specified.

9-05.7(2)A Basis for Acceptance (RC)

Section 9-05.7(2)A is supplemented with the following:

(*****)

All pipe shall be subject to (1) a three-edge-bearing strength (D-load) test in accordance with ASTM C76; and (2) a hydrostatic test of rubber gasket joints in accordance with ASTM C361 or AWWA C302 except test pressure shall be 5 psi.

9-05.7(3) Concrete Storm Sewer Pipe Joints (RC)

Section 9-05.7(3) is replaced by the following:

(*****)

Joint assembly design shall be reinforced concrete bell and spigot type incorporating a fully retained single rubber gasket in accordance with ASTM C361 or AWWA C302. Rubber gasket material shall be neoprene.

9-05.7(4) Testing Concrete Storm Sewer Pipe Joints (RC)

Section 9-05.7(4) is supplemented with the following:

(*****)

Hydrostatic testing of rubber gasket joints shall be performed in accordance with ASTM C361 or AWWA C302 except test pressure shall be 5 psi.

9-05.9 Steel Spiral Rib Storm Sewer Pipe (RC)

Section 9-05.9 is replaced with:

(*****)

The manufacturer of spiral rib storm sewer pipe shall furnish the Engineer a Manufacturer's Certificate of Compliance stating that the materials furnished comply in all respects with these Specifications. The Engineer may require additional information or tests to be performed by the Contractor at no expense to the City.

Unless otherwise specified, spiral rib storm sewer pipe shall be furnished with pipe ends cut perpendicular to the longitudinal axis of the pipe. Pipe ends shall be cut evenly. Spiral rib pipe shall be fabricated either by using a continuous helical lock seam or a continuous helical welded seam paralleling the rib.

Steel spiral rib storm sewer pipe shall be manufactured of metallic coated (aluminized or galvanized) corrugated steel and inspected in conformance with Section 9-05.4. The size, coating, and metal shall be as shown in the Plans or in the Specifications.

For spiral rib storm sewer pipe, helical ribs shall project outwardly from the smooth pipe wall and shall be fabricated from a single thickness of material. The ribs shall be essentially rectangular and shall be 3/4 inch plus two times the wall thickness (2t) plus or minus 1/8 inch (measured outside to outside) and a minimum of 0.95 inch high (measured as the minimum vertical distance from the outside of pipe wall immediately adjacent to the lockseam or stiffener to the top surface of rib). The maximum spacing of the ribs shall be 11.75 inches center to center (measured normal to the direction of the ribs). The radius of bend of the metal at the corners of the ribs shall be a minimum of 0.10 inch and a maximum of 0.17 inch. If the sheet between adjacent ribs does not contain a lockseam, a stiffener shall be included midway between ribs, having a nominal radius of 0.25 inch and a minimum height of 0.20 inch toward the outside of the pipe. Pipe shall be fabricated with ends that can be effectively jointed with coupling bands.

When required, spiral rib or narrow pitch spiral rib pipe shall be bituminous treated or paved. The bituminous treatment for spiral rib pipe shall conform to the requirements of Sections 9-05.4(3) and 9-05.4(4).

For narrow pitch spiral rib sewer pipe, the helical ribs shall project outwardly from the smooth pipe wall and shall be fabricated from a single thickness of material. The ribs shall be .375 inch + 1/8 inch wide (measured outside to outside) and a minimum of .4375 inch high (measured as the minimum vertical distance of ribs shall be 4.80 inches center to center (measured normal to the direction of the ribs). The radius of bend of the metal at the corners of the ribs shall be 0.0625 inch with an allowable tolerance of + 10 percent.

9-05.12 Polyvinyl Chloride (PVC) Pipe

Section 9-05.12(3) is a new additional section:

(*****)

Gravity sewer pipe shall be as specified herein and as shown on the Plans. The Contractor shall provide one electronic copy of the pipe manufacturer's technical literature including tables of dimensional tolerances to the Engineer. Any pipe found to have dimensional tolerances in excess of those prescribed or having defects, which prevent adequate joint seal or any other damage, shall be rejected. If requested by the Engineer, not less than three nor more than five lengths of pipe for each

size, selected from stock by the Engineer, shall be tested as specified for maximum dimensional tolerance or the respective pipe.

Materials shall meet the requirements of the following sections:

PVC sewer pipe – Section 9-05.12(1)

PVC (C900/C905) sewer pipe – Section 9-30.1(5)A

All pipe shall be clearly marked with type, class, and thickness. Lettering shall be legible and permanent under normal conditions of handling and storage.

9-05.14 ABS Composite Sewer Pipe

Section 9-05.14 is deleted in its entirety

(*****)

9-05.17 Aluminum Spiral Rib Storm Sewer Pipe

Section 9-05.17 is replaced with:

(*****)

Unless otherwise specified, spiral rib storm sewer pipe shall be furnished with pipe ends cut perpendicular to the longitudinal axis of the pipe. Pipe ends shall be cut evenly. Spiral rib pipe shall be fabricated by using a continuous helical lock seam with a seam gasket.

For spiral rib storm sewer pipe, helical ribs shall project outwardly from the smooth pipe wall and shall be fabricated from a single thickness of material. The ribs shall be 3/4 inch wide by 3/4 inch deep with a nominal spacing of 7-1/2 inches center to center. Pipe shall be fabricated with ends that can be effectively jointed with coupling bands.

For narrow pitch spiral rib storm sewer pipe, helical ribs shall project outwardly from the smooth pipe wall and shall be fabricated from a single thickness of material. The ribs shall be 0.375 inch + 1/8 inch wide (measured outside to outside) and a minimum spacing of ribs shall be 4.80 inches center to center (measured normal to the direction of the ribs). The radius of bend of the metal at the corners of the ribs shall be 0.0625 inch with an allowable tolerance of + 10 percent.

For wide pitch spiral rib storm sewer pipe, helical ribs shall project outwardly from the smooth pipe wall and shall be fabricated from a single thickness of material. The ribs shall be 3/4 inch \pm 1/8 inch wide (measured outside to outside) and a minimum of 0.95 inch high (measured as the minimum vertical distance from the outside of pipe wall to top surface of the rib). The maximum spacing of ribs shall be 11.75 inches center to center (measured normal to the direction of the ribs). The radius of bend of the metal at the corners of the ribs shall be 0.0625 inch with an allowable tolerance of \pm 10 percent.

9-05.20 Corrugated Polyethylene Storm Sewer Pipe (CPEP)

Section 9-05.19 is replaced with the following:

(*****)

9-05.20(1) Description

Corrugated Polyethylene Pipe (CPEP) shall be corrugated high-density polyethylene pipe with smooth internal wall manufactured by Advanced Drainage Systems (ADS), or approved equivalent.

9-05.20(2) Pipe Material and Fabrication

CPEP shall be in conformance with the latest version of ASTM F 667 or AASHTO M 294, Type S.

9-05.20(3) Fittings and Gaskets

Fittings shall be gasketed PVC fittings. Gaskets shall conform to ASTM F 477. Fittings shall conform to ASTM F 1536 or ASTM D 3212. Fittings shall be manufactured by Nyloplast USA, Inc., or approved equivalent.

9-05.20(4) Installation

Pipe and fittings shall be installed per the manufacturer's recommendations. Lubricate gasket and fitting socket with manufacturer-approved lubricant prior to pushing pipe into fitting.

9-05.24 Polypropylene Culvert Pipe, Polypropylene Storm Sewer Pipe, and Polypropylene Sanitary Sewer Pipe

This sections content is deleted and replaced with the following:

(*****)

All joints for polypropylene pipe shall be made with a bell/bell or bell and spigot coupling and shall conform to ASTM D 3212 using elastomeric gaskets conforming to ASTM F 477. All gaskets shall be factory installed on the pipe in accordance with the producer's recommendations.

Qualification for each producer of polypropylene storm sewer pipe requires joint system conformance to ASTM D 3212 using elastomeric gaskets conforming to ASTM F 477 and a formal quality control plan for each plant proposed for consideration.

A Manufacturer's Certificate of Compliance shall be required and shall accompany the materials delivered to the project. The certificate shall clearly identify production lots for all materials represented. The Contracting Agency may conduct verification tests of pipe stiffness or other properties it deems appropriate.

This section is supplemented with the following new sub-sections:

9-05.24(1) Polypropylene Culvert Pipe and Storm Sewer Pipe

Polypropylene culvert and storm sewer pipe shall conform to the following requirements:

1. For dual wall pipe sizes up to 30 inches: ASTM F2736.
2. For triple wall pipe sizes from 30 to 60 inches: ASTM F2764.
3. For dual wall profile pipe sizes 36 to 60 inches: AASHTO MP 21, Type S or Type D.
4. Fittings shall be factory welded, injection molded or PVC.

9-05.52 Dense Foam

Section 9-05.52 is a New Section as follows:

(*****)

Dense foam shall be Ethafoam HS 600 high density, polyethylene foam, as manufactured by Dow Chemical Company, or approved equivalent.

9-08 PAINTS AND RELATED MATERIALS

9-08.9 Manhole Coating System Products

Section 9-08.8 is a new section and subsections:
 (*****)

9-08.8(1) Coating Systems Specification

A. High Solids Urethane

Coating System:	C1
Coating Material:	High Solids Urethane
Surfaces:	Concrete
Surface Preparation:	In accordance with SSPC SP-7 (Sweep or brush off blast)
Application:	Shop: The drying time between coats shall not exceed 24 hours in any case
System Thickness:	3.0-4.0 mils dry film
Coatings:	Primer: One coat of Wasser MC-Shieldcoat 100 high solids urethane (1.5-2.0 DFT) Finish: One coat of Wasser MC-Shieldcoat 100 (min. 1.5-2.0 DFT)
Color:	White

9-14 EROSION CONTROL AND ROADSIDE PLANTING

9-14.1(1) Topsoil Type A

Section 9-14.1(1) is supplemented with the following:
 (*****)

Planting soil / topsoil shall consist of loose, moderately well-drained, friable soil of sandy loam texture, free of ice, snow and rubbish with no admixture of refuse or material toxic to plant growth. Soil shall be reasonably free of stones, lumps, roots, and weeds or similar objects. Topsoil should be fertile and free-flowing (pulverized). Topsoil shall be Mycorrhizae inoculated.

Topsoil shall meet the following parameters:

Parameter	Range
pH	6.7-7.5
Moisture Content	25%-55%
Soluble Salts	2.5 mmhos/(dS)
Coarse Sand	50%max (by weight)
Clay	25%max (by weight)
Silt	15%max (by weight)
Organic matter	10%max (by weight)

9-14.6(8) Sod

Section 9-14.6(8) is supplemented with the following:

(*****)

Sod shall be nursery-grown (farm-grown) under climatic conditions similar to or hardier than those at the site. Sod shall have normal habit of growth and be healthy, vigorous and free of disease, insects, insect eggs and larvae. Sod material shall meet or exceed the specification of Federal, State and local laws requiring inspection for plant disease and insect control.

Sod: Non-net “Premium Shadow Master” Sod Mixture from Emerald Turfgrass Farms, Inc., Sumner, WA, Ph: 253 838 9911 or 425 641 0608, or approved equal. Approved equal must be from a local grower and be established in growing sod in sandy loam soils. Sod grown in heavy clay soils is not acceptable. All required certifications apply for “approved equal”. Sod shall contain 65% perennial turf-type ryegrass by weight and 35% hard fescue by weight.

9-23 CONCRETE CURING MATERIALS AND ADMIXTURES

9-23.9 Fly Ash (RC)

Section 9-23.9 is revised with the following:

(*****)

Fly ash shall not be used around water lines.

9-30 WATER DISTRIBUTION MATERIALS

9-30.1 Pipe

Section 9-30.1 is supplemented and revised with the following:

(*****)

All materials for water distribution and transmission shall be new and undamaged. Prior to ordering any pipe and fittings to be used in a potable water supply, the Contractor shall submit the material source as required by Section 1-06.1 of the Standard Specifications. All direct and indirect drinking water system components which come in contact with potable water shall have National Sanitation Foundation (NSF) certification. All pipe and fittings shall be clearly marked with the manufacturer’s name, type, class, and thickness as applicable and shall be marked on the component at the place of manufacture. Marking shall be legible and permanent under normal conditions of handling and storage.

9-30.1(1) Ductile Iron Pipe

Section 9-30.1(1) is revised with the following:

(*****)

1. Ductile iron pipe shall be centrifugally cast in 18 or 20 foot nominal lengths and meet the requirements of AWWA C151. Ductile iron pipe shall have a double thick cement mortar lining and a 1-mil thick seal coat meeting the requirements of AWWA C104. Ductile iron pipe shall be minimum Standard Thickness Class 52 or the thickness class as shown in the Plans. Flanged ductile iron pipe shall be Class 53 per AWWA C115.
2. Non-restrained joint shall be rubber gasket, push-on type joint (Tyton) or mechanical joint (M.J.) conforming to AWWA C111, unless otherwise specified.
3. Restrained joints shall be as specified in Section 9-30.2(6).

4. Flanged joints shall conform to ANSI B16.1, class 125 drilling pattern, rated for 250 psi working pressure. Flanged ductile iron pipe shall be Class 53 per AWWA C 115. Thicker Classes are acceptable.

The Contractor shall furnish certification from the manufacturer of the pipe and gasket being supplied that the inspection and all of the specified tests have been made and the results thereof comply with the requirements of the above referenced standards.

9-30.1(2) Polyethylene Encasement

Section 9-30.1(2) is supplemented and revised with the following:

(*****)

Polyethylene encasement (plastic film wrap) shall be eight mil polyethylene, tube type conforming to AWWA C105. All ductile iron pipes and fittings shall be installed with a polyethylene encasement, tube-type and in black color.

9-30.2 Fittings

9-30.2(1) Ductile Iron Pipe

Section 9-30.2(1) is supplemented and revised with the following:

(*****)

Fittings for ductile iron pipe shall be ductile iron conforming to AWWA C110, and AWWA C111 or AWWA C153 and shall be cement-lined conforming to AWWA C104. All water main fittings shall be ductile iron, short body, cement lined and for pressure rating of 350 psi for mechanical joint fittings and 250 psi for flange joint fittings, unless otherwise specified. Metal thickness and manufacturing process shall conform to applicable portions of ANSI/AWWA C110/A21.10. Mechanical joint, ductile iron, compact fittings 24 inches and less shall conform to ANSI A21.53 (AWWA C153). Flanged fittings, cast or ductile iron, shall conform to ANSI B16.1, class 125 drilling pattern.

Ductile iron fittings include: tees, crosses, wyes, bends, adapters, sleeves, plugs, caps, offsets, reducers, and ells.

Rubber gaskets for push-on joints (Tyton) or mechanical joint (M.J.) shall conform to ANSI A21.11 / AWWA C111. Gasket materials for flange joints shall be neoprene, Buna N, chlorinated butyl, or cloth-inserted rubber suitable for pressurized water service purposes. Type of connections shall be specified as push-on joint (Tyton), mechanical joint (M.J.), plain end (P.E.), flanged (FL), restrained joint (RJ) and threaded.

Sleeves less than 12 inches in diameter shall be 12 inches minimum length and shall be mechanical joint. Sleeves greater than 12 inches in diameter shall be of the long body type and shall be 15 inches minimum length and shall be mechanical joint.

Where ductile iron pipe is to be joined to existing cast iron pipe of the same nominal size and the outside diameter of the existing cast iron pipe is 0.05 inches or less from the outside diameter of the ductile iron pipe being joined, the pipe shall be joined with a mechanical joint sleeve.

Where ductile iron pipe is to be joined to existing cast iron pipe of the same nominal size and the outside diameter of the existing cast iron pipe conforms to AWWA 1908 classifications A, B, C, D, or F,

the pipe shall be joined with a transition mechanical joint sleeve having a single-piece casting. Threaded pipe and flanges combinations shall not be used.

Bolts in piping and fittings shall be malleable iron, Cor-ten or stainless steel. Bolts and nuts for flanged pipe and fittings shall conform in size and length with ANSI/AWWA C111/A21.11. Stainless steel bolts shall meet the requirements of ASTM A-307, Grade A. Shackle rods shall be Cor-ten or stainless steel all thread 316SS. Stainless steel nuts and bolts shall be type 316SS.

Contractor shall provide Manufacturer's Certificate of Compliance in accordance with Section 1-06.3 Manufacturer's Certificate of Compliance of the Standards Specifications for all fittings and bolts to be used.

9-30.2(2) Galvanized Iron Pipe

Section 9-30.2(2) is a new section and shall read as follows:

(*****)

Where galvanized iron pipe is specified, the pipe shall be standard weight, Schedule 40, steel pipe per Standard Specifications for black and hot-dipped, zinc coated (galvanized) welded and seamless steel pipe for ordinary uses (ASTM A-120). Fittings shall be screwed malleable iron galvanized per ANSI B16.3.

9-30.2(3) Steel Casing Pipe

Section 9-30.2(3) is a new section and shall read as follows:

(*****)

Steel casing shall be black steel pipe conforming to ASTM A 53. Before installation, coat casing exterior with shop-applied anticorrosive coating conforming to AWWA C210. Minimum coating thickness shall be 16 mils dry film thickness (DFT); however, thickness shall not exceed manufacturer's recommended thickness. Coating type shall be a polyamide epoxy-coal tar equal to Tnemec Hi-Build Theme-Tar, Series 46H-413.

Casing wall thickness shall be 0.250 inch for casings 24 inches or less in diameter and 0.375 inch for casings over 24 inches in diameter.

Carrier pipe for water main shall be Restrained Joint Ductile Iron, Class 52.

(*****)

9-30.2(4) Spacers and Seals for Steel Casing Pipe

Casing spacers shall be "centered positioning" type bands at least 12 inch in width, and shall be either stainless steel or heavy duty fusion bonded epoxy coated steel. Runners shall be 2-inch wide glass reinforced plastic securely bonded to the spacer, and shall be aligned on the spacer along the axis of insertion of the water main into the casing pipe. Runner length shall approximate the width of the spacer. Securing the spacer to the water main shall be in accordance with the manufacturer's instruction. The height of the risers and runners combined shall be sufficient to keep the carrier pipe bell, couplings or fittings at least 0.75 inch from the casing pipe wall at all times and provide at least 1-inch clearance between the runners and the top of the casing wall, to prevent jamming during installation.

Acceptable spacers and end seals manufacturers are Pipeline Seal and Insulator model S12G-2 for stainless steel and model C12G-2, C8G-2 for fusion-bonded and coated steel, Cascade Waterworks Mfg. Co., Advance Products & Systems, Inc. or approved equal.

9-30.2(6) Restrained Joint

Section 9-30.2(6) including title is deleted and replaced with the following:
(*****)

9-30.2(6) Restrained Joint Pipe and Fittings

Restrained joints (RJ) ductile iron pipe and fittings, where required on the plans, shall be flexible after assembly and be able to be disassembled. Restrained joints shall meet the following criteria:

1. The restrained joint shall have a positive metal to metal contact locking system without the use of gripping teeth. Gaskets for push-on joint pipe with integrally molded steel or metal teeth or locking segments shall not be allowed as substitutes for restrained-joint pipes.
2. The joint restraint system for the pipe shall be the same as the joint restraint system for the pipe fittings, except as provided in item 4 below.
3. The joint restraint system for the pipe shall be boltless.
4. Where restrained joint fittings required on the plans cannot be furnished or where restrained jointed fittings are required in areas that are known to be subject to location adjustments, the Contractor may submit a lay plan showing mechanically jointed fittings with wedge restraint glands for approval. Mechanically jointed pipe with wedge restraint glands shall not be substituted for restrained joint pipe.

Wedge Restraint Glands

Wedge restraint glands shall conform to AWWA C111, ASTM A 536-80 Grade 65-42-12. All bolts and wedges shall be ductile iron. Wedge shall be heat-treated to a minimum 370 BHN. Wedge restraint glands shall be rated for 350 psi for pipe 12 inch in diameter and smaller.

9-30.2(7) Bolted, Sleeve-Type Couplings for Plain End Pipe

Section 9-30.2(7) is revised with the following:
(*****)

Transition couplings, reducing couplings, transition reducing couplings, sleeves, flexible couplings for water main shall be compression type by pipe manufacturer: Romac or Ford or approved equal. Bolts and nuts shall be high strength, low alloy steel, corrosion resistant per AWWA C111. Stainless steel bolts require anti-seize compound. Heavy hex nuts shall be used.

The long body pattern with a minimum center ring or center sleeve length of 12-inches for pipe less than 12 inches in diameter and equal to or greater than the pipe diameter for pipe greater than 12 inches in diameter. Solid sleeves (greater than 12 inch diameter) shall be a 15 inch minimum length.

9-30.3 Valves

Section 9-30.3 is supplemented and revised with the following:
(*****)

The valves shall be a standard pattern of a manufacturer whose products are approved by the Engineer and shall have the name or mark of the manufacturer, year valve casting was made, size and working pressure plainly cast in raised and legible letters on the valve body. All valves shall be NSF

approved and valve bodies shall be ductile iron. All valves shall be stamped with "NSF APPROVED" and "DI".

Where a valve is required to operate in a higher pressure environment than the Class of valve specified in Section 9-30.3, the class of valve shall be as specified in the Contract.

9-30.3(1) Gate Valves (3 inches to 16 inches)

Section 9-30.3(1) is supplemented and revised with the following:

(*****)

All valve material shall be new and undamaged. Unless otherwise approved by the Engineer, the same manufacturer of each item shall be used throughout the work.

All gate valves shall be ductile iron body, bronze mounted, resilient seat, non-rising stem and shall be equipped with a standard two (2) inch square operating nut and O-ring stem seals. Valves shall open counterclockwise when viewed from above. Valves shall be designed for a minimum water operating pressure of 200 PSI.

Resilient seated gate valves shall be manufactured to meet or exceed the requirements of AWWA Standard C-509 and C-515 latest revisions.

Valve ends shall be mechanical joints, flanged joints or mechanical by flanged joints as shown on the project plans. Where restrained joints are called out, valve ends shall be flanged with appropriate flange by restrained joint adapters.

All gate valves shall include an 8" x 24" cast iron gate valve box and extensions, as required. A valve stem extension is required where the valve operating nut is more than 3 feet below finished grade. Valve stem extensions are to be a minimum of 1 foot with only one extension per valve in shall be installed in accordance to the City of Renton standard plans.

Acceptable gate valves are Clow, M & H/Kennedy, American Flow Control (ACIPCo), Pratt/Mueller, US Metroseal or approved equal in sizes 16 inches and less.

Approval of valves other than models specified shall be obtained prior to bid opening.

9-30.3(3) Butterfly Valves

Section 9-30.3(3) is supplemented and revised with the following:

(*****)

In addition to the requirements of section 9-30.3, water main butterfly valves shall conform to AWWA C504 and shall be Class 150B. The valve shall be short-body type and shall have flanged ends. Flanged ends shall be sized and drilled in conformance with ANSI B16.1 Class 125. Valve shall be suitable for direct bury and shall have a stem extension with AWWA 2-inch square operating nut and suitable valve box. All butterfly valves bodies and discs shall be ductile iron.

The butterfly valves shall be manufactured by Henry Pratt Company, Mueller, DeZurick, Mosser Valve Division of Olsen Technologies, Dresser 450, Pratt Groundhog or approved equal.

9-30.3(4) Valve Boxes

Section 9-30.3(4) is supplemented and revised with the following:

(*****)

Valve boxes shall be installed on all buried valves. The box and lid shall be cast iron, 2-piece slip type with cast iron extension as necessary, conforming to the City of Renton latest standard plans. The cover shall have the word "WATER" cast in it and shall have cast-iron "ears" installed in the direction of the main. Valve box extension pieces shall be provided for valves with groundcover in excess of the depth of the standard valve box.

Acceptable manufacturers of valves boxes and covers are Olympic Foundry, Inc., EJCO, Rich (Varnish Casting Corp.)

9-30.3(5) Valve Marker Posts

Section 9-30.3(5) is supplemented and revised with the following:

(*****)

Valve markers shall be Carsonite composite utility marker .375"x 6'-0" or approved equal with blue label "water". The valve markers shall be installed in conformance with the City of Renton Standard Plans.

9-30.3(6) Valve Stem Extensions

Section 9-30.3(6) is supplemented and revised with the following:

(*****)

Valve stem extensions shall have a 2-inch square operating nut and self-centering rockplate. A valve stem extension is required where the valve operating nut is more than 3 feet below finished grade. Valve stem extensions are to be a minimum of 1 foot with only one extension per valve in shall be installed in accordance to the City of Renton standard plans.

9-30.3(7) Combination Air Release/Air Vacuum Valves

Section 9-30.3(7) is supplemented and revised with the following:

(*****)

Combination air release/air vacuum valves shall comply with the requirements of ANSI/AWWA C512. Air and vacuum release valves shall be APCO No. 143C- Valve and Primer Corp, "Heavy-Duty," combination air release valve, Val-Matic No. 201C, Crispin UL10 or approved equal. Installation shall be per the City of Renton Standard Details, latest revision. Piping and fitting shall be copper or brass. Location of the air release valve as show on the plans is approximate. The installation shall be set at the actual high point of the line.

9-30.3(8) Tapping Sleeve and Valve Assembly

Section 9-30.3(8) is supplemented and revised with the following:

(*****)

Tapping sleeves shall be cast iron, ductile iron, or epoxy coated steel. Bolt and nuts shall be Cor-Ten or stainless steel.

9-30.3(9) Blow-Off Assembly

Section 9-30.3(9) is a new section:

(*****)

Installation of blow-off assembly shall be per City of Renton Standard Details, latest revision. Pipe and fittings shall be galvanized. Blow-off assembly shall be installed at location(s) shown on the plans.

Temporary blow-off assembly on new dead-end water main shall be installed at location shown on the plans. Temporary blow-off assemblies for testing and flushing of the new water mains will not be included under this item and shall be considered incidental to the contract and no additional payment shall be made.

9-30.5 Hydrants

Section 9-30.5 is supplemented and revised with the following:

(*****)

Fire hydrants shall conform to AWWA C502 and shall be of standard manufacture and of a pattern approved by the City of Renton. The name or mark of the manufacturer, size of the valve opening and year made shall be plainly cast in raised letters on the hydrant barrel to be visible after the hydrant is installed.

Hydrants of the following manufacture and pattern have been approved by the City of Renton.

Clow Medallion, M&H 929, Mueller Centurion Model A-423, Waterous Pacer, American Darling Model B-62B, Kennedy K81D Guardian, East Jordan WaterMaster 5CD250.

9-30.5(1) End Connections

Section 9-30.5(1) is revised with the following:

(*****)

Hydrant end connections shall be mechanical joint connection unless otherwise specified in the description of the bid of proposal.

9-30.5(2) Hydrant Dimensions

Section 9-30.5(2) is replaced with the following:

(*****)

Fire hydrants shall have a valve opening with minimum diameter of 5-1/4 inches, "O" ring stem seal, two 2-1/2 inches National Standard Thread (N.S.T.) hose nozzle connections, one 4-inches pumper port connection with City of Seattle standard threats and with a 4.875" Seattle thread x 5" Storz adapter attached with a 1/8" stainless steel cable. The shoe connection and hydrant connection inside pipe size and auxiliary gate valve shall be 6 inches, mechanical joint with lugs. The operating nut and port cap nuts are 1-1/4-inch pentagonal.

Hydrant restraint system shall be two 3/4-inch diameter Cor-Ten steel shackle rods with a poured in place concrete thrust block behind the hydrant shoe. If a wedge restraint system is used in lieu of shackle rods, mechanical joint pipe shall be used. Hydrants shall be provided with a breakaway flange assembly and be equipped with breaking devices at the sidewalk.

The hydrant curb stand section of the hydrant that is above ground including all exposed surfaces of the breakaway flange shall be painted with 2 field coats of paint Kelly-Moore Luxlite or approved equal in Safety Yellow color.

Fire hydrants shall be installed per City of Renton Standard Details for fire hydrants, latest revisions.

9-30.6 Water Service Connections (2 Inches and Smaller)

9-30.6(3) Service Pipes

9-30.6(3)B Polyethylene Pipe

Section 9-30.6(3)B is revised to read as follows:

(*****)

Polyethylene pipe shall not be used.

9-30.6(4) Service Fittings

Section 9-30.6(4) has been revised with the following:

(*****)

Fittings used for copper tubing shall be compression type with gripper ring.

9-30.6(5) Meter Setters

Section 9-30.6(5) has been supplemented with the following:

(*****)

Meter setters shall be installed per the City of Renton Standard Details for water meters, latest revision.

9-30.6(7) Meter Boxes

Section 9-30.6(7) has been supplemented with the following:

(*****)

Meter boxes shall be installed per the City of Renton Standard Details for water meters, latest revision.

SECTION 10

10-01 MARKING PAINT REMOVAL

The permittee will be required to remove utility locate marks on sidewalks only within the Downtown Core Area. The permittee shall remove the utility locate marks within 14 days of job completion.

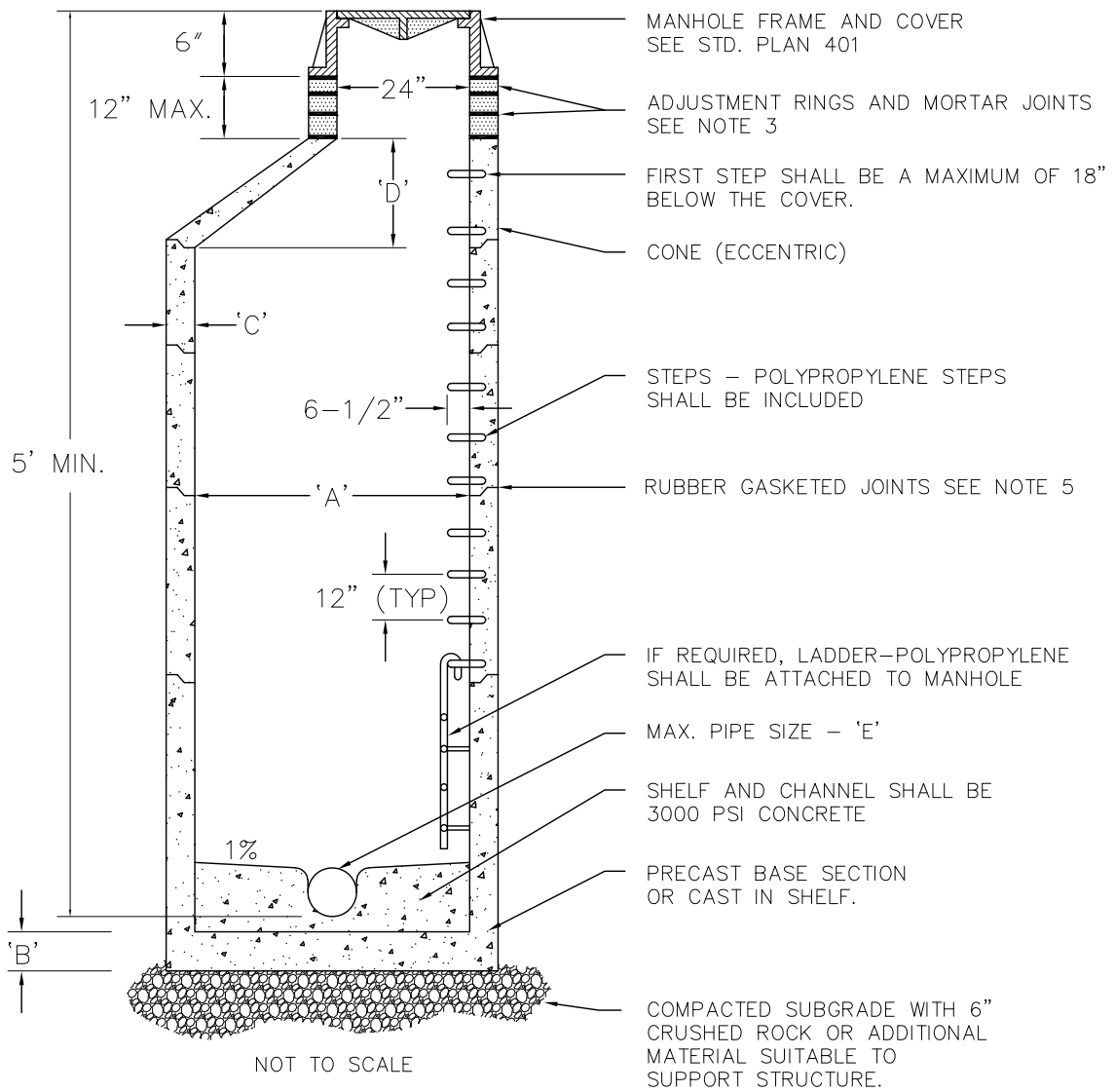

	'A'	'B'	'C'	'D'	'E'
48" MH	48"	6" MIN.	5" MIN.	24" MIN.	21" I.D.
54" MH	54"	8" MIN.	5.5" MIN.	24" MIN.	24" I.D.
60" MH	60"	8" MIN.	6" MIN.	42" MIN.	30" I.D.

NOTES:

1. STEPS ARE TO BE IN PLACE BEFORE MANHOLE SECTIONS ARE INSTALLED.
2. MANHOLE SECTIONS TO BE OF REINFORCED PRECAST CONCRETE IN CONFORMANCE WITH ASTM C-478.
3. ADJUSTMENT OF THE CASTING TO GRADE SHALL BE PER STD PLAN 106. THE USE OF SHIMS IS PROHIBITED.
4. SANITARY SEWER MANHOLES SHALL HAVE ALL INTERIOR SURFACES, INCLUDING CHANNELING, FACTORY-COATED (SEALED) WITH A HIGH SOLIDS URETHANE COATING; WASSER MC-SHIELDCOAT 100 OR APPROVED EQUAL; COLOR OF COATING SHALL BE WHITE.
5. RUBBER GASKETED JOINTS SHALL BE IN CONFORMANCE WITH ASTM C-443.
6. CHANNEL WIDTH AND HEIGHT SHALL BE MATCH THE DIAMETER OF THE LARGEST PIPE.
7. CONNECTIONS TO MANHOLE SHALL BE MADE USING KOR-N-SEAL BOOTS OR APPROVED EQUAL.
8. IN UNIMPROVED AREAS, MANHOLES SHALL EXTEND A MINIMUM OF 6" AND A MAXIMUM OF 12" ABOVE FINISHED GRADE OR MUST HAVE AN AT-GRADE, MINIMUM 2' CONCRETE RING POURED AROUND THE COVER. IN PAVED AREAS, COVER MUST SLOPE TO MATCH PAVING.
9. MANHOLES OVER 20' DEEP SHALL BE A MINIMUM OF 60" IN DIAMETER.



PUBLIC WORKS
DEPARTMENT

STANDARD SANITARY MANHOLE

STD. PLAN - 400.1

APPROVED:

XXXXXXXXXXXX
Public Works Administrator

DATE

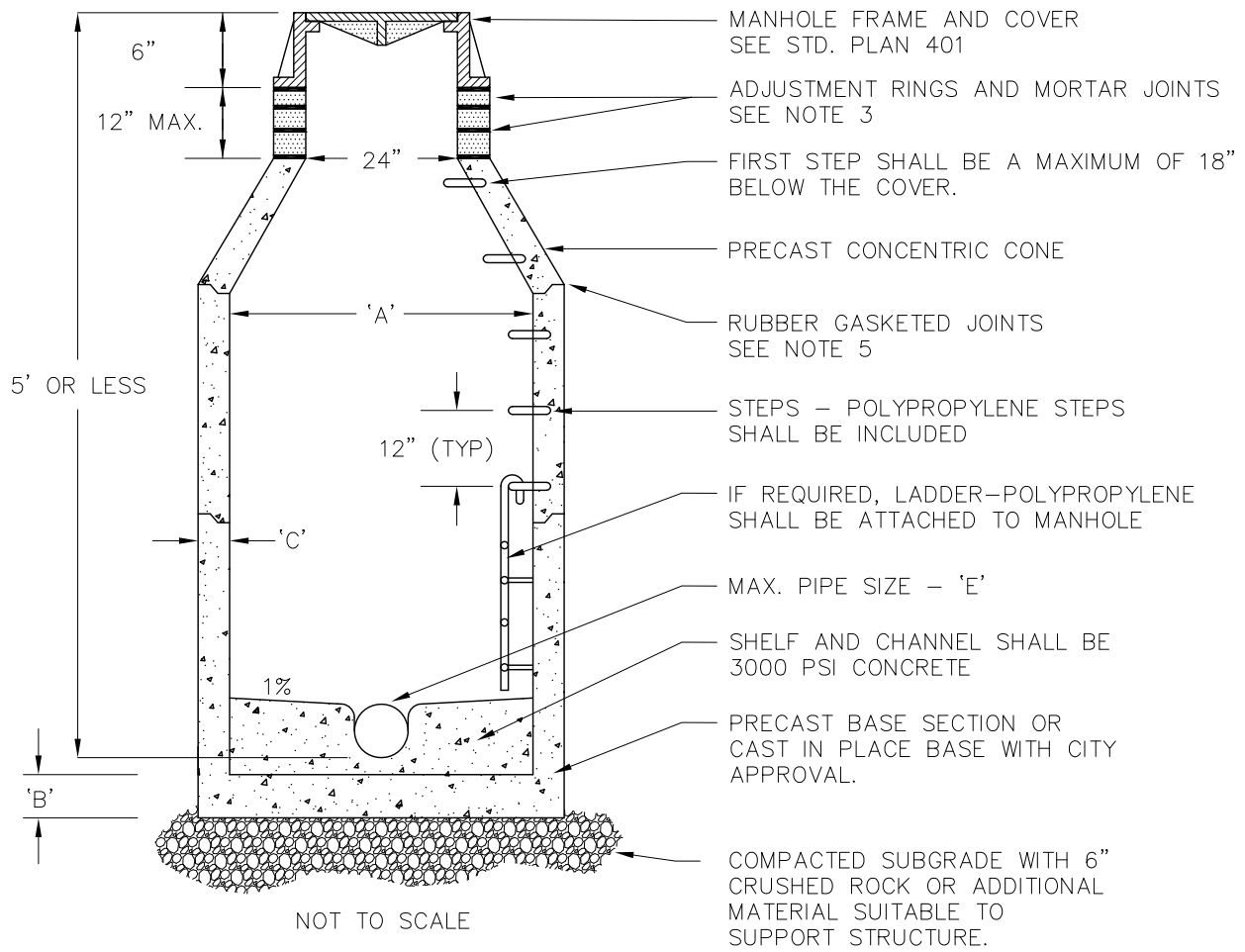

	'A'	'B'	'C'	'D'	'E'
48" MH	48"	6" MIN.	5" MIN.	24" MIN.	21" I.D.
54" MH	54"	8" MIN.	5.5" MIN.	24" MIN.	24" I.D.
60" MH	60"	8" MIN.	6" MIN.	42" MIN.	30" I.D.

NOTES:

1. STEPS ARE TO BE IN PLACE BEFORE MANHOLE SECTIONS ARE INSTALLED.
2. MANHOLE SECTIONS TO BE OF REINFORCED PRECAST CONCRETE IN CONFORMANCE WITH ASTM C-478.
3. ADJUSTMENT OF THE CASTING TO GRADE SHALL BE PER STD PLAN 106. THE USE OF SHIMS IS PROHIBITED.
4. SANITARY SEWER MANHOLES SHALL HAVE ALL INTERIOR SURFACES, INCLUDING CHANNELING, FACTORY-COATED (SEALED) WITH A HIGH SOLIDS URETHANE COATING; WASSER MC-SHIELDCOAT 100 OR APPROVED EQUAL; COLOR OF COATING SHALL BE WHITE.
5. RUBBER GASKETED JOINTS SHALL BE IN CONFORMANCE WITH ASTM C-443.
6. CHANNEL WIDTH AND HEIGHT SHALL EQUAL THE INSIDE DIAMETER OF THE LARGEST PIPE.
7. CONNECTIONS TO MANHOLE SHALL BE MADE USING KOR-N-SEAL BOOTS OR APPROVED EQUAL.
8. IN UNIMPROVED AREAS, MANHOLES SHALL EXTEND A MINIMUM OF 6" AND A MAXIMUM OF 12" ABOVE FINISHED GRADE OR SHALL HAVE AN AT-GRADE, MINIMUM 2'-WIDE CONCRETE RING POURED AROUND THE COVER. IN PAVED AREAS, COVER MUST SLOPE TO MATCH PAVING.

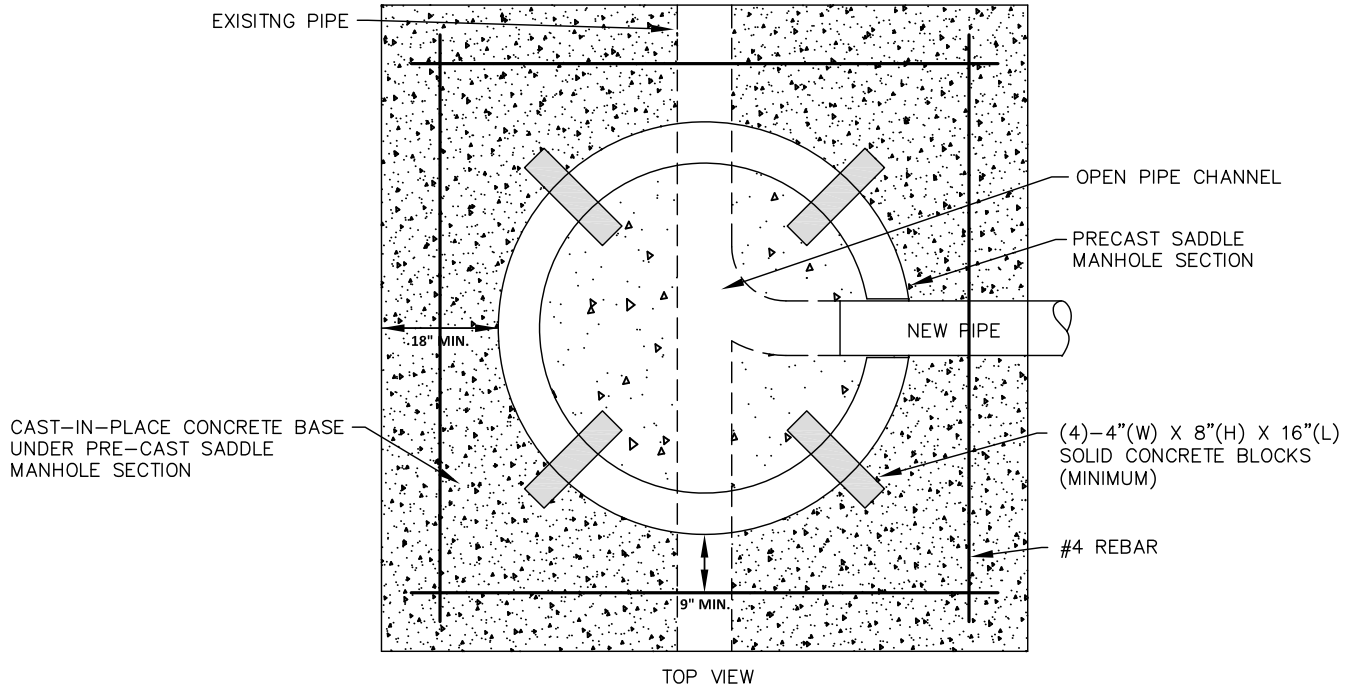

TOP VIEW

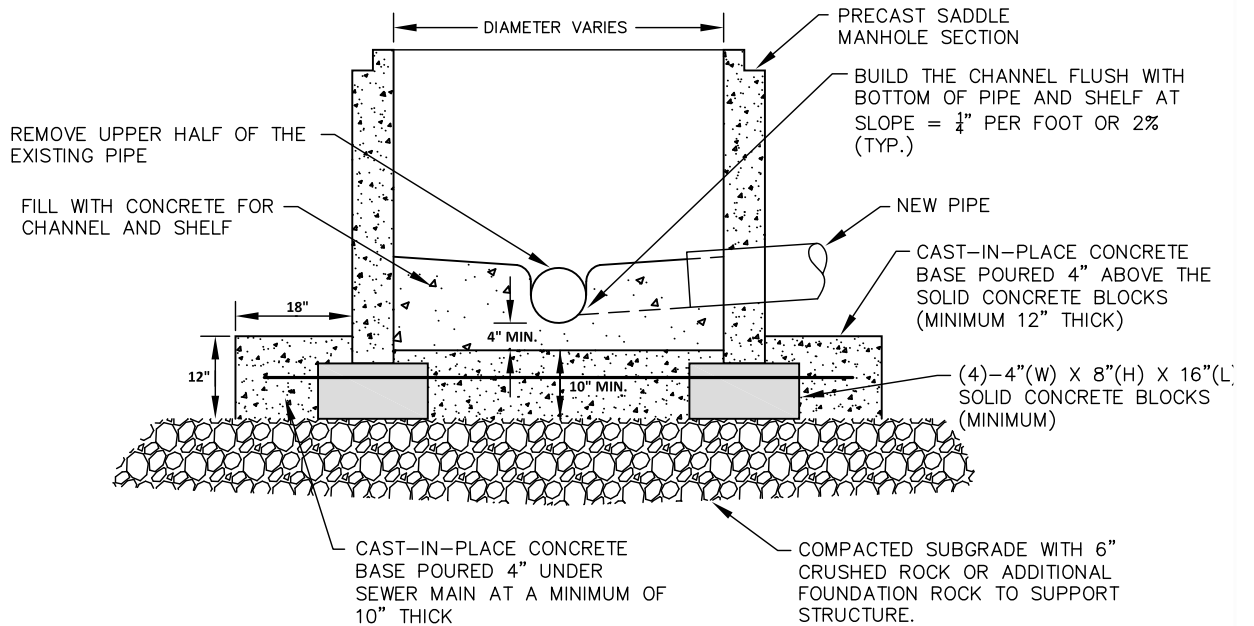

NOTES:

1. EXISTING PIPE SHALL BE SUPPORTED AT ALL TIMES.
2. NO WEIGHT OF THE PRECAST MANHOLE UNIT SHALL BEAR ON THE EXISTING PIPE.
3. CAST-IN-PLACE BASE SHALL BE 3000 PSI COMMERCIAL CONCRETE.
4. PRECAST MANHOLE SECTIONS SHALL BE INSTALLED IN ACCORDANCE WITH THE STANDARD PLAN FOR THE SPECIFIED MANHOLE SIZE AND TYPE.
5. PRECAST MANHOLE SECTIONS SHALL HAVE THE INTERIOR SURFACES FACTORY-COATED (SEALED) WITH A HIGH SOLIDS URETHANE COATING; WASSER MC-SHIELDCOAT 100 OR APPROVED EQUAL; COLOR SHALL BE WHITE.
6. THE PRECAST MANHOLE SECTION SHALL SIT ON (4)-4"(W) X 8"(H) X 16"(L) SOLID CONCRETE BLOCKS PLACED ON COMPACTED SUB-GRADE.
7. THE UPPER HALF OF THE EXISTING PIPE SHALL BE REMOVED WHILE THE BOTTOM SHALL REMAIN AS THE CHANNEL OF THE NEW MANHOLE.
8. THE CAST-IN-PLACE MANHOLE SHALL NOT BE INSTALLED OVER A BELL SECTION OR JOINT OF THE SEWER MAIN. THE MINIMUM DISTANCE FROM THE OUTSIDE WALL OF THE MANHOLE AND A BELL SECTION OR JOINT SHALL BE 2'.



PUBLIC WORKS
DEPARTMENT

**SADDLE MANHOLE
WITH CAST-IN-PLACE BASE**

STD. PLAN - 400.6

APPROVED:

Gregg Zimmerman
Public Works Administrator

DATE

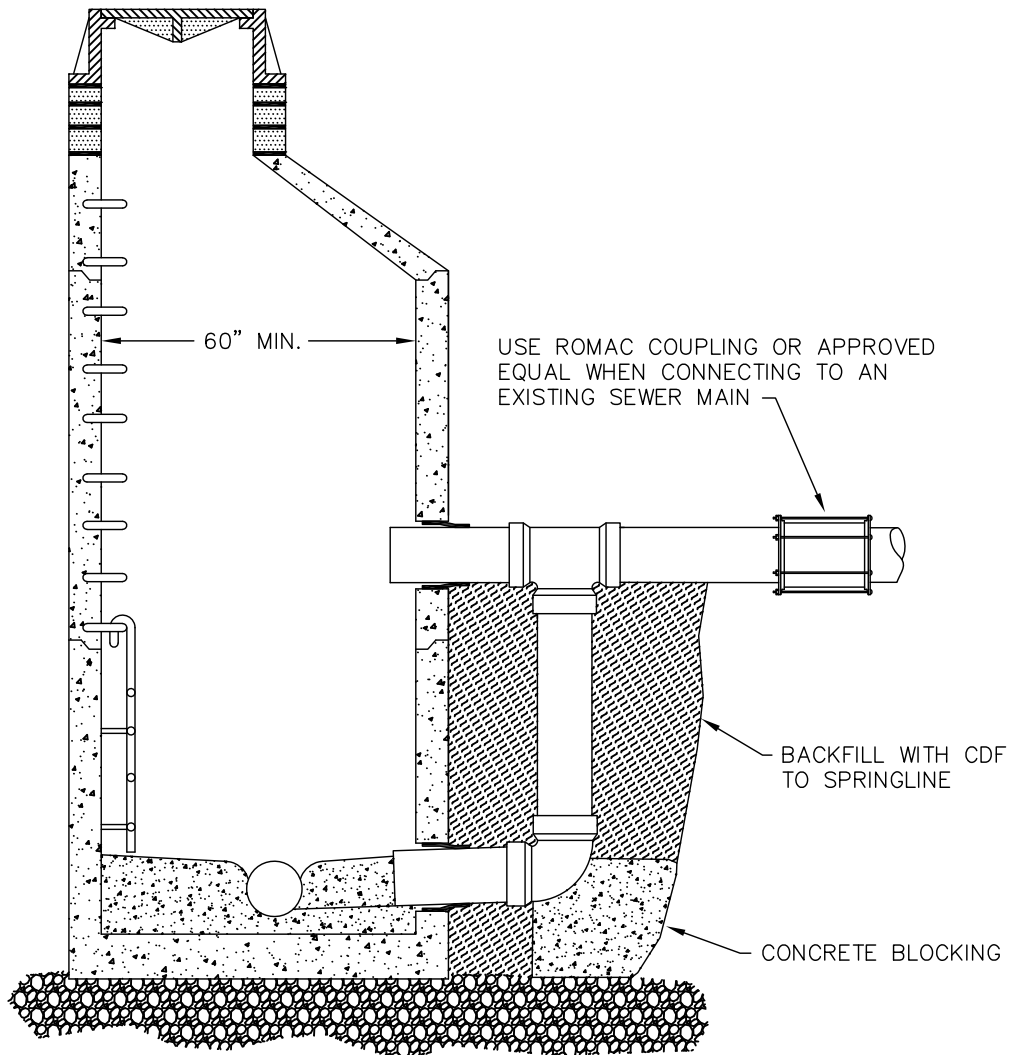

NOTES:

1. OUTSIDE DROPS SHALL BE INSTALLED ONLY WHERE APPROVED BY THE CITY.
2. MANHOLE SHALL CONFORM TO ALL APPLICABLE REQUIREMENTS OF STANDARD PLAN 400.1.
3. OUTSIDE DROP SHALL BE THE SAME DIAMETER AS THE EXISTING SEWER MAIN
4. NEW DROPS THAT CONNECT TO ALL EXISTING SEWER MAIN LINE MATERIALS EXCEPT DUCTILE IRON SHALL BE PVC SDR 35. DROPS CONNECTING TO DUCTILE IRON SHALL BE AWWA C900 PIPE WITH AWWA C907 FITTINGS.
5. DROP TEE SHALL BE A MINIMUM OF 3 FEET BELOW THE CONE SECTION.
6. MANHOLE SHALL BE CORE-DRILLED FOR NEW DROP. USE KOR-N-SEAL CONNECTORS OR APPROVED EQUAL.
7. CHANNEL BASE WITH 3000 PSI CONCRETE. WIDTH AND DEPTH OF CHANNEL SHALL MATCH THE LARGEST DIAMETER PIPE. SLOPE SHELF TO CHANNEL AT 1-INCH PER FOOT MIN.
8. USE ROMAC COUPLING OR EQUAL WHEN CONNECTING TO AN EXISTING SEWER MAIN.
9. MANHOLE CONE SECTION AND ACCESS LADDER MAY NEED TO BE RELOCATED TO ALLOW DROP.



PUBLIC WORKS
DEPARTMENT

**OUTSIDE DROP CONNECTION
FOR SANITARY MANHOLE**

STD. PLAN - 402.1

APPROVED:

Gregg Zimmerman
Public Works Administrator

DATE

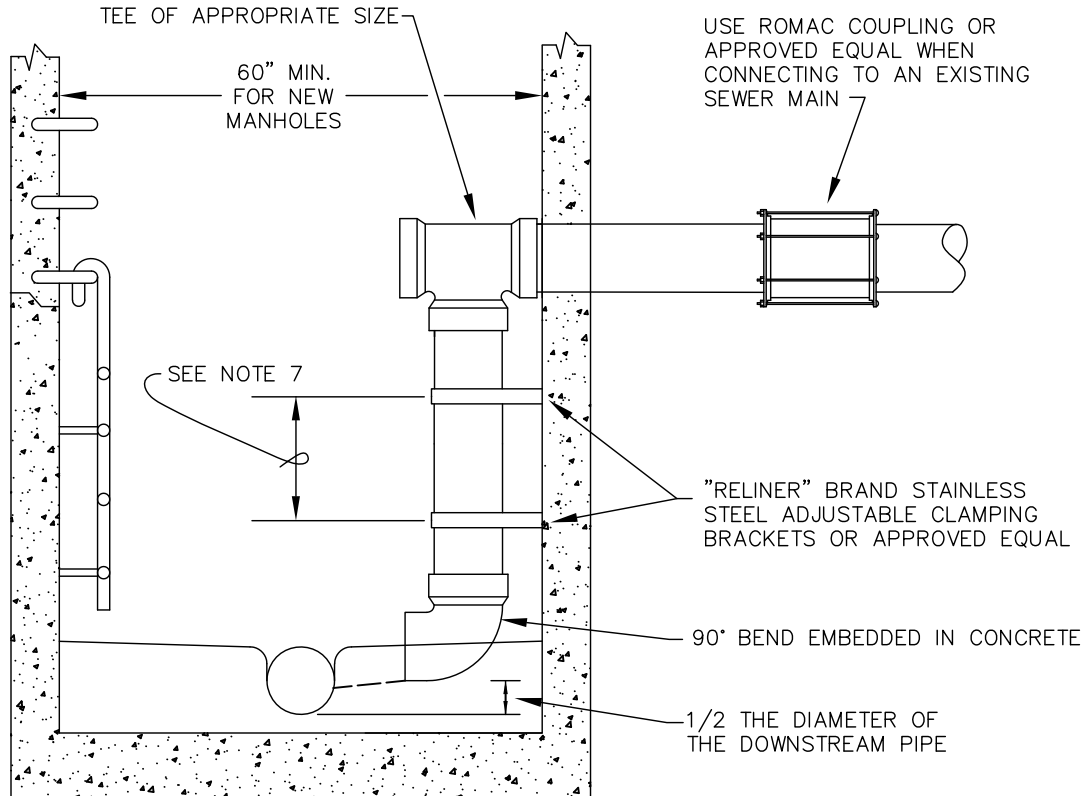

NOTES:

1. SANITARY SEWER DROPS ARE ONLY TO BE USED UPON APPROVAL BY THE WASTEWATER UTILITY SECTION.
2. DROP PIPES AND FITTINGS SHALL BE PVC SDR 35 WHEN CONNECTING TO ALL EXISTING SEWER MAIN MATERIALS EXCEPT DUCTILE IRON. USE AWWA C900 PIPE AND AWWA C907 FITTING WHEN CONNECTING TO DUCTILE IRON SEWER MAINS.
3. MINIMUM SIZE MANHOLE FOR INSIDE DROP CONNECTION SHALL BE 60" DIAMETER.
4. CONNECTIONS TO MANHOLE SHALL BE CORE DRILLED AND USE KOR-N-SEAL BOOTS OR APPROVED EQUAL.
5. USE ROMAC COUPLING OR APPROVED EQUAL WHEN CONNECTING TO AN EXISTING MAIN.
6. WITHIN A 60" DIAMETER MANHOLE, THE MAXIMUM ALLOWABLE DIAMETER OF THE INSIDE DROP PIPING IS 12". INSIDE DROPS EXCEEDING 12" IN DIAMETER OR MULTIPLE DROPS SHALL BE REVIEWED BY THE WASTEWATER UTILITY AND MAY REQUIRE A LARGER DIAMETER MANHOLE.
7. "RELINER" BRAND STAINLESS STEEL ADJUSTABLE CLAMPING BRACKETS OR APPROVED EQUAL SHALL BE INSTALLED WITHIN 6" OF BOTH BELL AND SPIGOT ENDS OF EACH DROP PIPE. IF DROP PIPE LENGTH EXCEEDS 5 FEET THEN CENTER STRAPS SHALL BE INSTALLED WITH A MAXIMUM SPACING OF 4 FEET ON CENTER. BRACKETS SHALL BE ATTACHED UTILIZING STAINLESS STEEL EXPANSION BOLTS, MIN. 2 EACH AT CONNECTION POINTS.
8. MANHOLE CONE SECTION AND ACCESS LADDER MAY NEED TO BE RELOCATED TO ALLOW DROP.



PUBLIC WORKS
DEPARTMENT

**INSIDE DROP CONNECTION
FOR SANITARY MANHOLE**

STD. PLAN - 402.2

APPROVED:

Gregg Zimmerman
Public Works Administrator

DATE

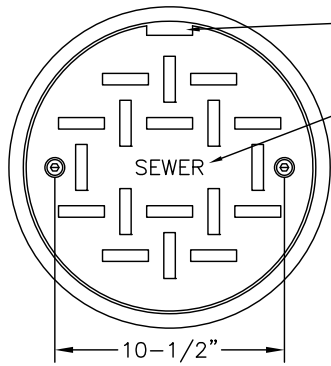

(2) BOLT SOC. (ALLEN HEAD)
5/8" - 11 X 1.5 STAINLESS
STEEL
REF. PART #00981177

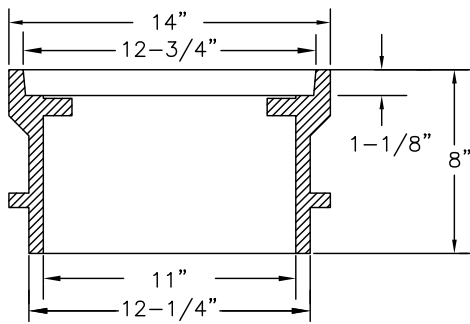
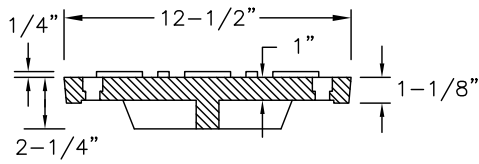
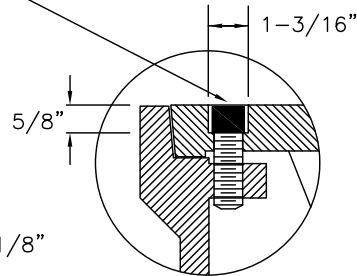

CAST IRON RING AND COVER

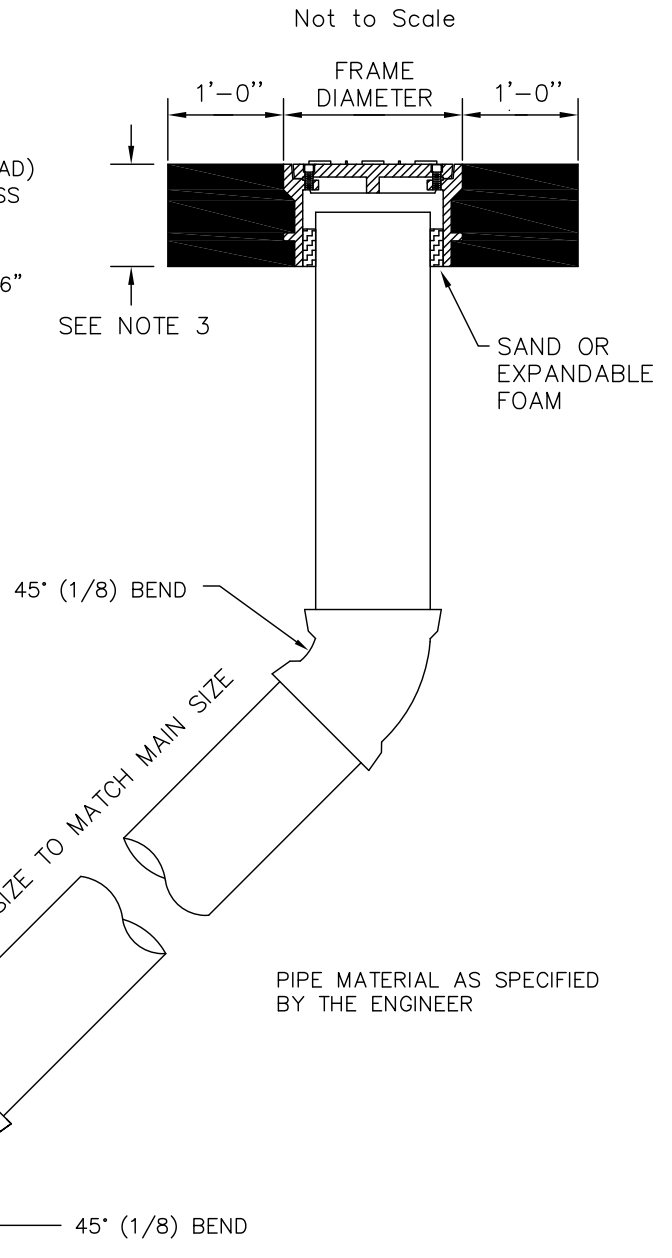

NOTES:

1. 8" AND 6" CLEAN-OUT RINGS AND COVERS ON SEWER MAINS SHALL BE EAST JORDAN IRON WORKS, INC. No. 3698 (PRODUCT NO. 00369803) OR APPROVED EQUAL. CLEAN OUT SHALL BE A WATER TIGHT ASSEMBLY.
2. IN UNIMPROVED AREAS, POUR A 8" THICK, 3'-0" SQUARE CONCRETE, CLASS 3000, PAD AROUND THE RING AND COVER.
3. INSTALL ASPHALT COLLAR PER STANDARD PLAN 106.



PUBLIC WORKS
DEPARTMENT

8" OR 6" CLEANOUT
FOR SANITARY SEWER MAIN

STD. PLAN - 403.1

APPROVED:

Gregg Zimmerman
Public Works Administrator

DATE

(2) BOLT SOC. (ALLEN HEAD)
 5/8" - 11 X 1.5 STAINLESS
 STEEL
 REF. PART #00981177

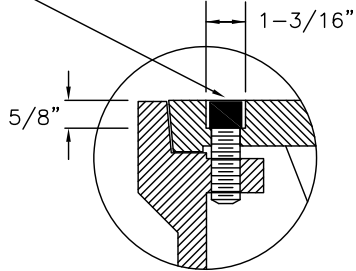

BOLT DETAIL

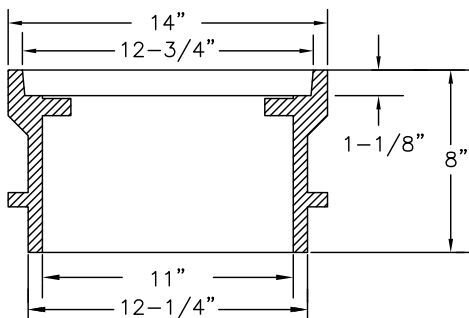
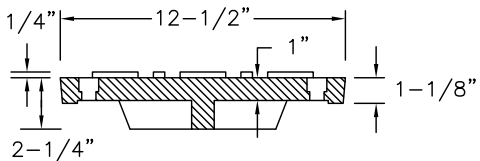
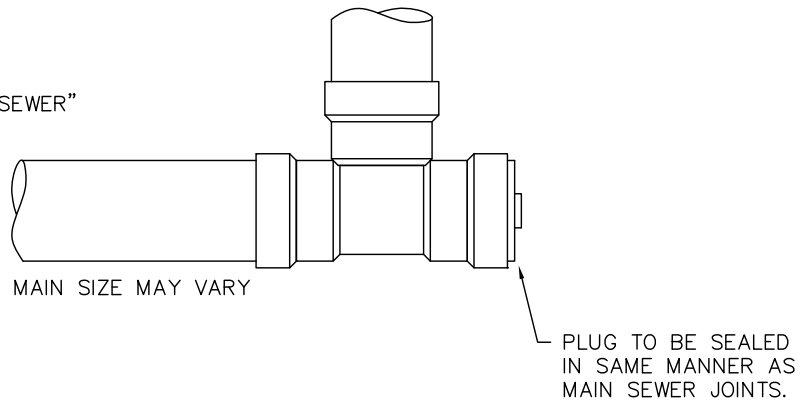
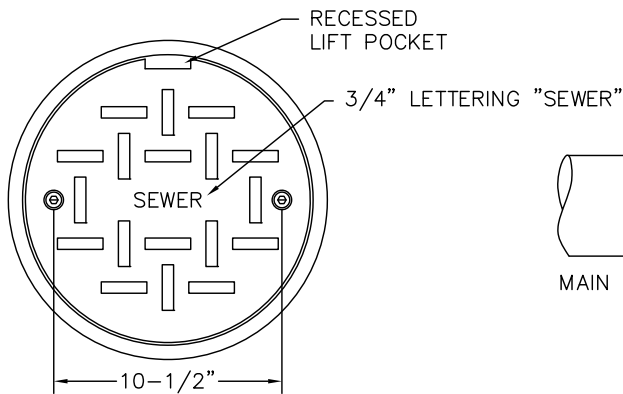
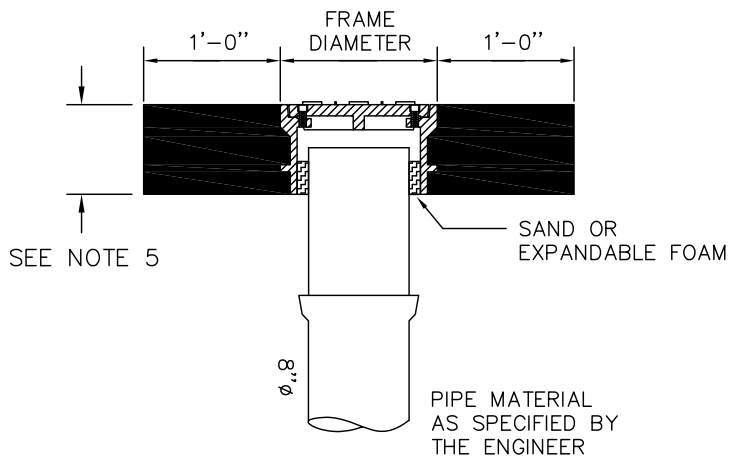

CAST IRON RING & COVER

NOTE:

1. CLEAN-OUT IS ONLY TO BE USED AT THE PERMISSION OF THE CITY OF RENTON ENGINEER.
2. THIS CLEAN-OUT IS ONLY TO BE USED FOR "DRY" SEWER LINES THAT MAY BE EXTENDED IN THE FUTURE. ITS PURPOSE IS TO ALLOW THE ENGINEER TO DETERMINE THE INVERT ELEVATION OF THE PIPE FOR FUTURE SEWER EXTENSION DESIGN. ALL "ACTIVE" SEWERS SHALL USE STANDARD PLAN 403.1.
3. RING AND COVER SHALL BE EAST JORDAN IRON WORKS, INC. NO.3698 (PRODUCT NO. 00369803) OR APPROVED EQUAL.
4. IN UNIMPROVED AREAS, POUR 8" THICK BY 3'-0" SQUARE CONCRETE, CLASS 3000, PAD AROUND RING.
5. INSTALL ASPHALT COLLAR PER STANDARD PLAN 106.



PUBLIC WORKS
 DEPARTMENT

**8" CLEANOUT
 FOR "DRY" SEWER MAIN**

STD. PLAN - 403.2

APPROVED:

Gregg Zimmerman
 Public Works Administrator

DATE

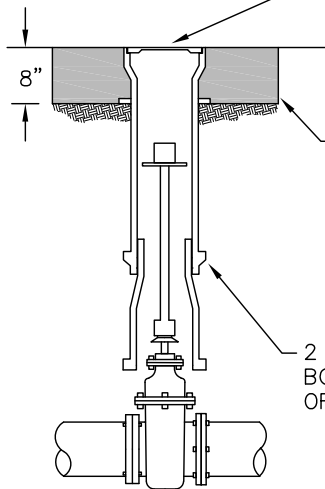
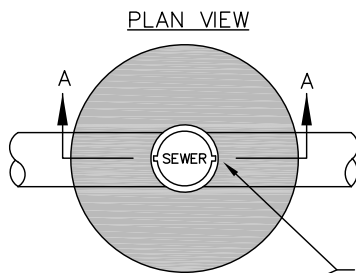

VALVE BOX LID WITH EARS IN DIRECTION OF SEWER MAIN AND WORD "SEWER" CAST INTO IT.

INSTALL 8" THICK HMA COLLAR FOR VALVES IN PAVED AREAS PER STD PLAN 106 OR 6" THICK, 3'x3' CONCRETE PAD IN UNPAVED AREAS.

2 PIECE CAST IRON VALVE BOX, RICH-SEATTLE TYPE OR OLYMPIC FOUNDRY

SECTION A-A

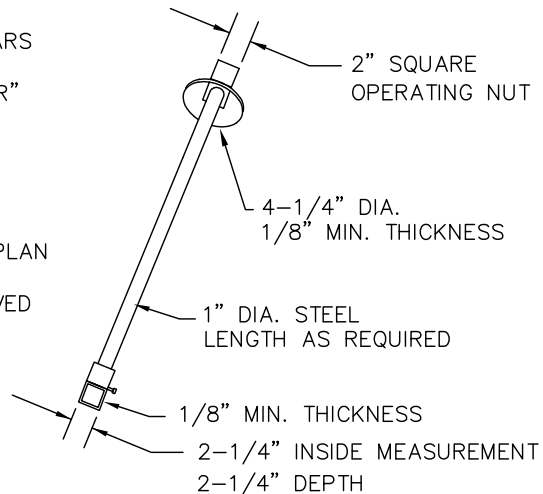

VALVE OPERATING NUT EXTENSION

VALVE OPERATION NUT EXTENSION NOTE:

EXTENSIONS ARE REQUIRED WHEN VALVE NUT IS MORE THAN THREE (3) FEET BELOW FINISHED GRADE. EXTENSIONS ARE TO BE A MINIMUM OF ONE (1) FOOT LONG. ONLY ONE EXTENSION TO BE USED PER VALVE.

NOTE: ALL EXTENSIONS ARE TO BE MADE OF STEEL, SIZED AS NOTED, AND PAINTED WITH TWO COATS OF METAL PAINT.

VALVE OR MANHOLE MARKER NOTES:

MARKERS SHALL BE EQUAL TO CARSONITE UTILITY MARKER.

MARKER POST TO BE USED FOR ALL MAIN LINE VALVES OR MANHOLES OUTSIDE PAVED AREAS.

MARKER POST SHALL IDENTIFY VALVES OR MANHOLES AS SEWER.

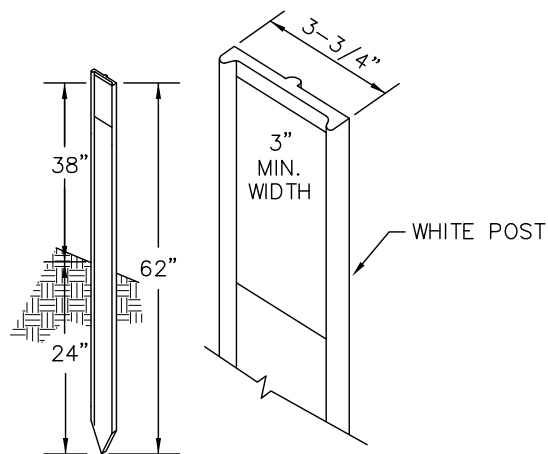

VALVE MARKER POST



PUBLIC WORKS DEPARTMENT

SEWER VALVE OPERATING EXTENSION AND MARKER POST

STD. PLAN - 404.1

APPROVED:

Gregg Zimmerman
Public Works Administrator

DATE

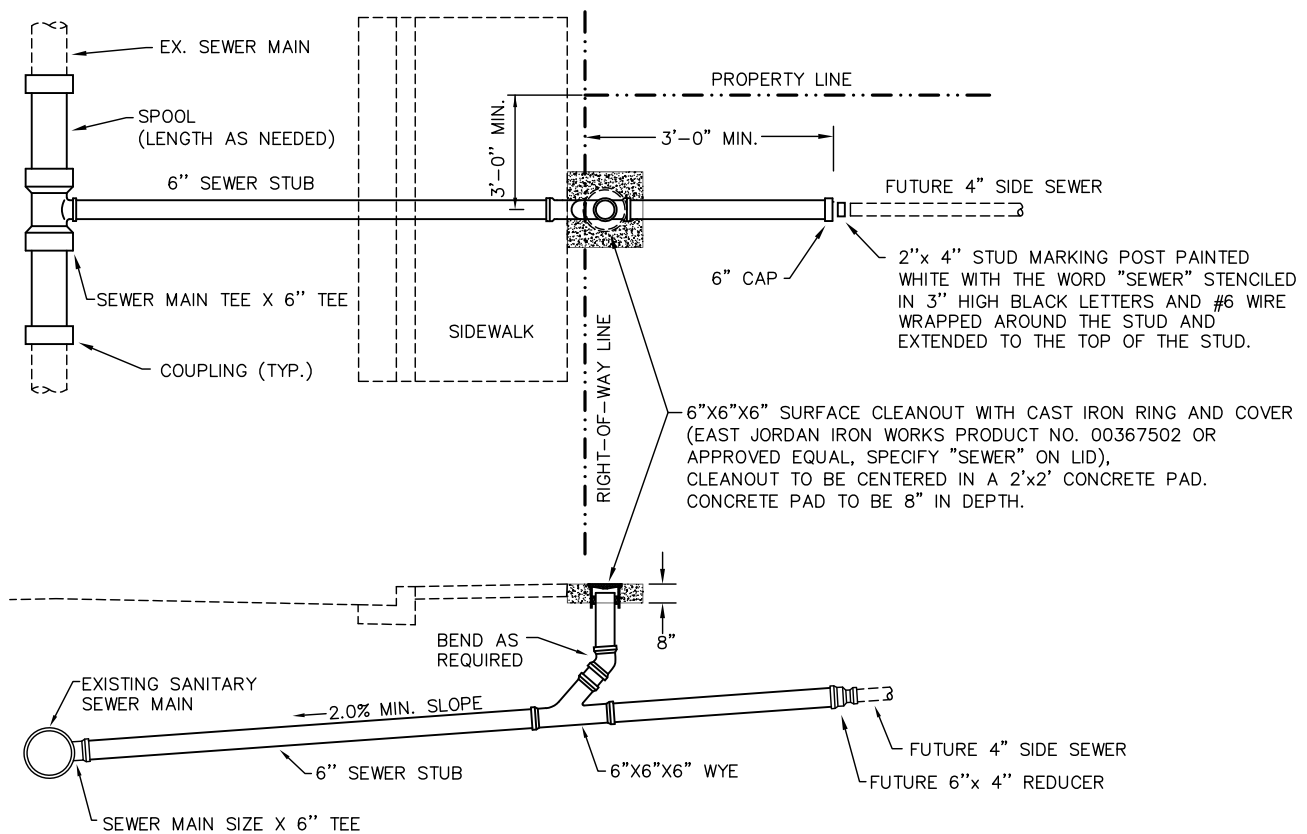

ACCEPTABLE PROCEDURES FOR SIDE SEWER CONNECTIONS TO EXISTING SEWER MAIN

- A. VITRIFIED CLAY MAIN – CUT IN A NEW PVC "TEE" USING "STRONG-BACK" FLEXIBLE COUPLINGS (FERNCO OR APPROVED EQUAL).
- B. CONCRETE MAIN – CUT IN A NEW PVC "TEE" USING "STRONG-BACK" FLEXIBLE COUPLINGS (FERNCO OR APPROVED EQUAL).
- C. PVC & C900 PVC MAIN – CUT IN NEW TEE USING RIGID COUPLINGS OR CORE-DRILLED WITH A ROMAC SADDLE (OR APPROVED EQUAL).
- D. DUCTILE IRON MAIN – CORE-DRILLED WITH A ROMAC SADDLE (OR APPROVED EQUAL)
- E. LINED MAIN – CONNECTION TO SEWER MAINS THAT HAVE BEEN LINED (CIPP, ETC.); CUT IN A NEW PVC "TEE" USING "STRONG-BACK" FLEXIBLE COUPLINGS (FERNCO OR APPROVED EQUAL).
- F. HDPE – CORE-DRILLED WITH A ROMAC SADDLE. "INSERTA-TEE" MAY BE USED ON SEWER MAINS 12" DIAMETER OR LARGER.
- G. MANHOLE CONNECTION – ALL CONNECTIONS TO MANHOLES SHALL BE AT MANUFACTURED KNOCK-OUTS OR THE STRUCTURE SHALL BE CORE-DRILLED AND USE KOR-N-SEAL BOOTS OR APPROVED EQUAL.

NOTES:

- 1. PRIOR TO INSTALLATION OF A SANITARY SEWER STUB, A SIDE SEWER STUB PERMIT MUST BE PURCHASED FROM THE CITY OF RENTON PUBLIC WORKS DEPARTMENT.
- 2. UNLESS OTHERWISE SHOWN ON PLAN, SIDE SEWER SHALL HAVE A MINIMUM 2.5' COVER AT PROPERTY LINE OR 3-5' LOWER THAN THE LOWEST HOUSE ELEVATION, WHICHEVER IS LOWER.
- 3. SIDE SEWERS SHALL HAVE A MINIMUM 2 % SLOPE UNLESS APPROVED BY THE PUBLIC WORKS INSPECTOR.
- 4. FOR INSPECTION OF THE SIDE SEWER STUB, CALL 24 HOURS IN ADVANCE. THE INSPECTION PHONE NUMBER IS ON THE SIDE SEWER STUB PERMIT. SITE MUST BE READY FOR INSPECTION AND A REPRESENTATIVE ON SITE WHEN INSPECTOR ARRIVES AT THE APPOINTED TIME. DO NOT BACKFILL THE TRENCH UNTIL APPROVAL IS GIVEN BY THE INSPECTOR.
- 5. ALL TRENCH RESTORATION FOR SIDE SEWERS IN THE PUBLIC RIGHT-OF-WAY SHALL CONFORM TO STANDARD PLAN 110 OR 110.2.
- 6. THE SIDE SEWER STUB SHALL HAVE PIPE BEDDING IN ACCORDANCE WITH STANDARD PLAN 405.
- 7. ALL SIDE SEWER STUBS SHALL BE INSTALLED BY A CONTRACTOR LICENSED AND BONDED IN THE STATE OF WASHINGTON.



PUBLIC WORKS DEPARTMENT

SIDE SEWER STUB INSTALLATION (SEWER MAIN TO PROPERTY LINE)

STD. PLAN - 406.1

APPROVED:

Gregg Zimmerman
Public Works Administrator

DATE

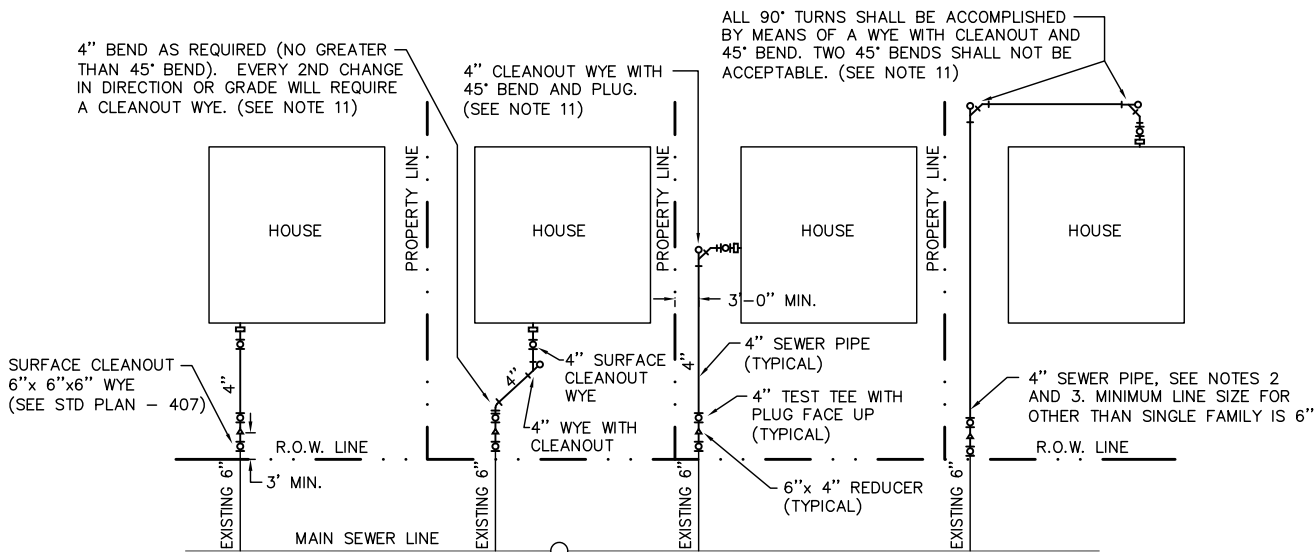

ALL 90° TURNS SHALL BE ACCOMPLISHED BY MEANS OF A WYE WITH CLEANOUT AND 45° BEND. TWO 45° BENDS SHALL NOT BE ACCEPTABLE. (SEE NOTE 11)

4" BEND AS REQUIRED (NO GREATER THAN 45° BEND). EVERY 2ND CHANGE IN DIRECTION OR GRADE WILL REQUIRE A CLEANOUT WYE. (SEE NOTE 11)

4" CLEANOUT WYE WITH 45° BEND AND PLUG. (SEE NOTE 11)

4" SEWER PIPE, SEE NOTES 2 AND 3. MINIMUM LINE SIZE FOR OTHER THAN SINGLE FAMILY IS 6"

4" SEWER PIPE (TYPICAL)
4" TEST TEE WITH PLUG FACE UP (TYPICAL)
6" x 4" REDUCER (TYPICAL)

SURFACE CLEANOUT 6" x 6" x 6" WYE (SEE STD PLAN - 407)

R.O.W. LINE
3' MIN.

MAIN SEWER LINE

NOTES:

1. PRIOR TO INSTALLATION OF A SANITARY SEWER CONNECTION, A SIDE-SEWER PERMIT MUST BE PURCHASED FROM THE CITY OF RENTON PUBLIC WORKS DEPARTMENT.
2. FOR INSPECTION OF SIDE SEWER, CALL 24 HOURS IN ADVANCE. THE INSPECTION PHONE NUMBER IS ON THE SIDE SEWER PERMIT. SITE MUST BE READY FOR INSPECTION AND A REPRESENTATIVE ON SITE WHEN INSPECTOR ARRIVES AT APPOINTED TIME. DO NOT BACKFILL THE DITCH UNTIL APPROVAL IS GIVEN BY THE INSPECTOR.
3. SIDE SEWER PIPE AND FITTINGS SHALL BE PVC SDR 35 WITH RUBBER GASKET JOINTS UNLESS OTHERWISE APPROVED BY THE PUBLIC WORKS DEPARTMENT.
4. A MINIMUM GRADE OF 2% (1/4" PER FOOT) MUST BE MAINTAINED WITH A 4" PIPE. IN THE EVENT A 2% GRADE CANNOT BE MAINTAINED, WITH THE APPROVAL OF THE PUBLIC WORKS INSPECTOR, THE CONTRACTOR MAY INSTALL A 6" DIAMETER SIDE SEWER AT NO LESS THAN 1%.
5. INSTALL SIDE SEWER WITH 2' MINIMUM COVER. 18" COVER IS ALLOWED AT THE HOUSE IF OUTLET IS SHALLOW.
6. ALL BUILDING SEWER AND SIDE SEWERS SHALL HAVE BEDDING IN ACCORDANCE WITH STANDARD PLAN 405.
7. WHENEVER FEASIBLE, THERE SHALL BE A MINIMUM 5 FOOT HORIZONTAL SEPARATION BETWEEN SANITARY SIDE SEWERS AND ALL OTHER UTILITIES.
8. SIDE SEWER TESTING SHALL CONSIST OF PLACING A PLUG IN THE TEST TEE AND INSTALLING A 4-FOOT RISER PIPE ON THE CLEANOUT AT THE BUILDING. THE SIDE SEWER PIPE SHALL BE FILLED TO WITH WATER TO THE TOP OF THE RISER PIPE. NO LOSS OF WATER SHALL OCCUR FOR A PERIOD OF 10 MINUTES. THE SIDE SEWER MAY BE CONNECTED TO THE BUILDING FOLLOWING THE SUCCESSFUL COMPLETION OF THE LEAK TEST.
9. THE CLEANOUT AT THE RIGHT-OF-WAY SHALL BE INSTALLED PER STANDARD PLAN 406.1. THE CLEANOUT AT THE BUILDING SHALL BE INSTALLED TO SURFACE GRADE. ALL OTHER CLEANOUTS SHALL BE INSTALLED TO WITHIN 12" OF THE SURFACE.
10. IF SIDE SEWER STUB IS NOT AVAILABLE. THE OWNER SHALL BE RESPONSIBLE FOR ITS INSTALLATION PER STANDARD PLAN 406.1. ALL WORK WITHIN STREET RIGHT-OF-WAY SHALL BE DONE BY A LICENSED AND BONDED CONTRACTOR.
11. ALL TRENCH RESTORATION FOR SIDE SEWERS IN THE PUBLIC RIGHT-OF-WAY SHALL CONFORM TO STANDARD PLAN 110 OR 110.2.
12. ALL WORK SHALL BE ACCOMPLISHED IN ACCORDANCE WITH THE WASHINGTON INDUSTRIAL SAFETY AND HEALTH ACT (WISHA).

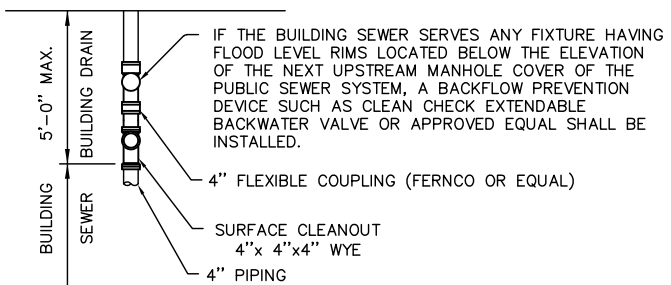

PLAN
BUILDING DRAIN FOR LOW ELEVATION HOUSE

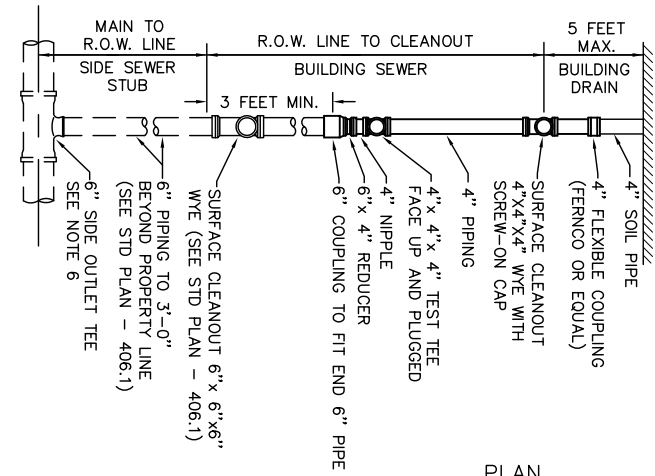

PLAN
BUILDING SEWER INSTALLATION

CALL 811 BEFORE YOU DIG
or go to
www.callbeforeyoudig.org



PUBLIC WORKS DEPARTMENT

TYPICAL BUILDING SEWER FROM PROPERTY LINE TO BUILDING CONNECTION

STD. PLAN - 406.2

APPROVED:

Gregg Zimmerman
Public Works Administrator

DATE

SURFACE CLEANOUT WITH
 CAST IRON RING AND COVER
 (EAST JORDAN IRON WORKS PRODUCT NO.
 00367502 OR APPROVED EQUAL, SPECIFY
 "SEWER" ON LID), (SEE STD. PLAN 406.1
 FOR INSTALLATION)

R.O.W.

EXISTING 6" SEWER STUB
 (REMOVE TO R.O.W LINE)

BEND AS
 REQUIRED

EXISTING SANITARY SEWER MAIN
 (REMOVE)

6"X6"X6" WYE

6"x 4" REDUCER

EXISTING 4" SIDE SEWER

BEND AS REQUIRED
 (NOT TO EXCEED 45')

PROPOSED 6" SEWER STUB

SEWER MAIN SIZE X 6" TEE

PROPOSED SEWER MAIN

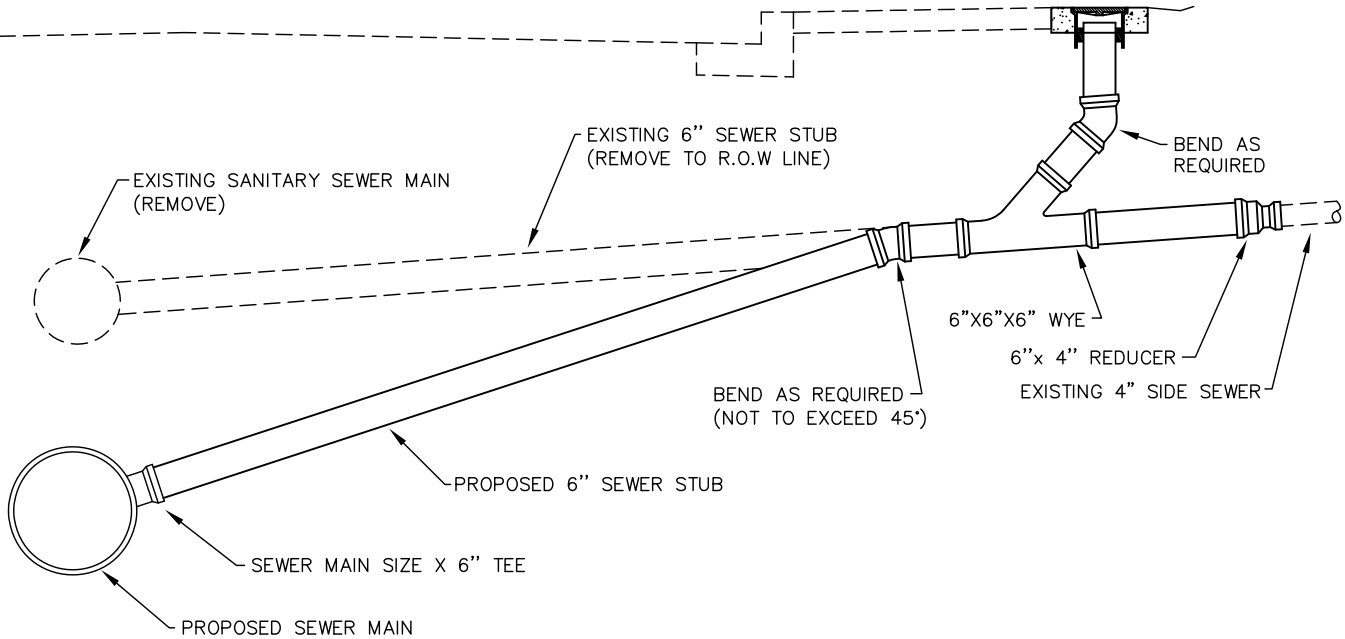
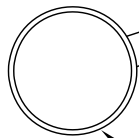

PUBLIC WORKS
 DEPARTMENT

**TYPICAL SIDE SEWER CONNECTION
 FOR SEWER MAIN REPLACEMENT**

STD. PLAN - 407

APPROVED:

Gregg Zimmerman
 Public Works Administrator

DATE

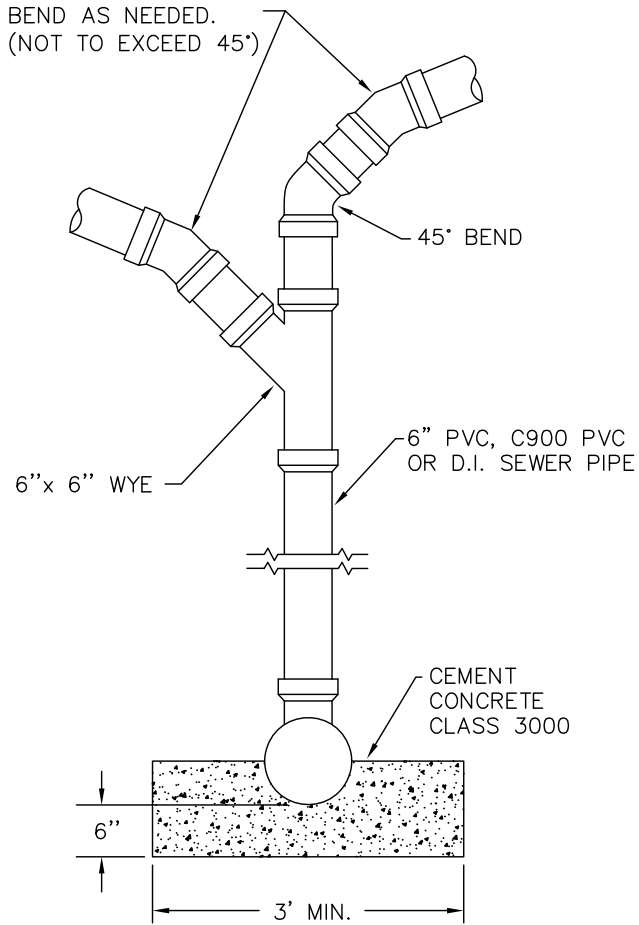

SECTION B-B

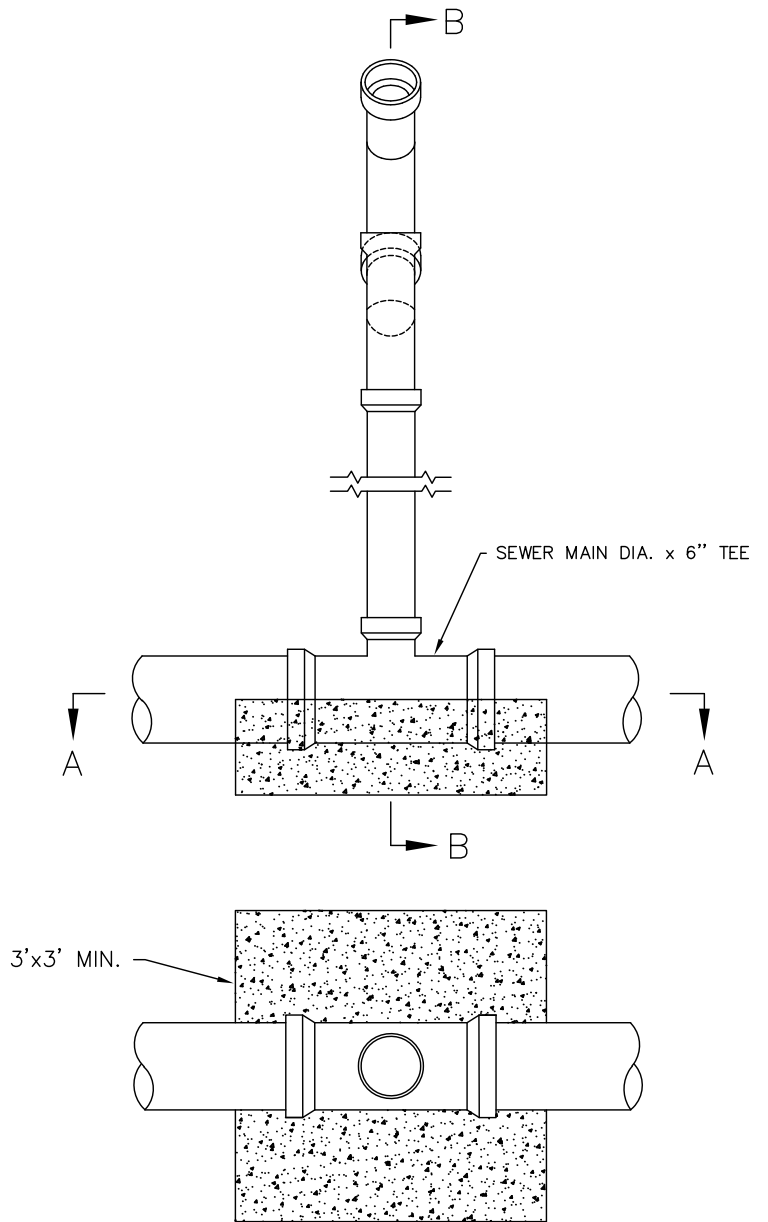

SECTION A-A

NOTES:

1. UTILIZATION OF THIS DETAIL REQUIRES WRITTEN APPROVAL OF THE WASTEWATER UTILITY.
2. CCTV INSPECTION OF THE SEWER MAIN SHALL BE PERFORMED FOLLOWING VERTICAL CONNECTION. INSPECTION SHALL SHOW NEW CONNECTION AS WELL AS THE SEWER MAIN FOR A MINIMUM DISTANCE OF 10 FEET UPSTREAM AND DOWNSTREAM OF THE CONNECTION.



PUBLIC WORKS
DEPARTMENT

**SINGLE OR DUAL SIDE SEWER SERVICE
VERTICAL CONNECTION**

STD. PLAN - 408

APPROVED:

Gregg Zimmerman
Public Works Administrator

DATE

WASTEWATER UTILITY STANDARD NOTES

1. ALL WORK AND MATERIAL SHALL BE IN CONFORMANCE WITH THE STANDARDS AND SPECIFICATION OF THE CITY OF RENTON PUBLIC WORKS DEPARTMENT AND THE LATEST EDITION OF THE WSDOT/APWA STANDARDS AND SPECIFICATIONS, AS APPROVED AND MODIFIED BY THE CITY OF RENTON STANDARD PLANS & SPECIFICATIONS. A SET OF APPROVED PLANS SHALL BE KEPT ON SITE AT ALL TIMES DURING CONSTRUCTION.
2. DATUM FOR VERTICAL CONTROL SHALL BE NORTH AMERICAN VERTICAL DATUM 1988. HORIZONTAL CONTROL SHALL BE NORTH AMERICAN DATUM 1983/1991 UNLESS OTHERWISE APPROVED BY THE CITY. BENCHMARKS AND MONUMENTS SHALL BE REFERENCED ON THE APPROVED PLANS.
3. A PRE-CONSTRUCTION CONFERENCE AND A 24-HOUR NOTICE SHALL BE REQUIRED PRIOR TO STARTING NEW CONSTRUCTION. IT SHALL BE THE CONTRACTOR'S RESPONSIBILITY TO SECURE ALL NECESSARY PERMITS, INCLUDING STREET USE PERMITS, PRIOR TO STARTING CONSTRUCTION. INSPECTION WILL BE ACCOMPLISHED BY A REPRESENTATIVE OF THE CITY. IT SHALL BE THE CONTRACTOR'S RESPONSIBILITY TO NOTIFY THE PUBLIC WORKS INSPECTOR 24 HOURS IN ADVANCE OF BACKFILLING ALL CONSTRUCTION.
4. THE HOURS OF WORK IN THE STREET RIGHT-OF-WAY SHALL BE PER CITY SPECIFICATIONS ON WEEKDAYS UNLESS OTHERWISE APPROVED IN WRITING BY THE PUBLIC WORKS DEPARTMENT. AN APPROVED TRAFFIC CONTROL PLAN MUST BE OBTAINED PRIOR TO BEGINNING ANY WORK WITHIN THE PUBLIC RIGHT-OF-WAY.
5. CONTRACTOR IS SOLELY RESPONSIBLE FOR THE MEANS, METHODS AND SEQUENCES OF CONSTRUCTION AND FOR THE SAFETY OF WORKERS AND OTHERS ON THE CONSTRUCTION SITE IN ACCORDANCE WITH LOCAL, STATE AND FEDERAL REQUIREMENTS.
6. ALL LOCATIONS OF EXISTING UTILITIES SHOWN ARE APPROXIMATE AND IT SHALL BE THE CONTRACTOR'S RESPONSIBILITY TO VERIFY THE TRUE AND CORRECT LOCATION SO AS TO AVOID DAMAGE OR DISTURBANCE. THE CONTRACTOR SHALL COMPLY WITH THE REQUIREMENTS OF RCW 19.122. A DIG TICKET SHALL BE OBTAINED A MINIMUM OF TWO BUSINESS DAYS PRIOR TO STARTING ANY EXCAVATION. THE CONTRACTOR SHALL HAVE A COPY OF THE DIG TICKET ON SITE AT ALL TIMES.
7. BACKFILL SHALL BE PLACED EQUALLY ON BOTH SIDES OF THE PIPE IN LAYERS WITH A LOOSE AVERAGE DEPTH OF 12-INCHES, MAXIMUM DEPTH 18-INCHES, THOROUGHLY COMPACTING EACH LAYER TO 95 PERCENT OF MAXIMUM DENSITY. THESE COMPACTED LAYERS MUST EXTEND FOR ONE PIPE DIAMETER ON EACH SIDE OF THE PIPE OR TO THE SIDE OF THE TRENCH. MATERIALS TO COMPLETE THE FILL OVER THE PIPE SHALL BE EQUIVALENT TO BANK RUN GRAVEL FOR TRENCH BACKFILL (9-03.19).
8. SANITARY SEWER PIPE SHALL BE POLYVINYL CHLORIDE (PVC) RUBBER-GASKETED ASTM D 3034, SDR 35, OR DUCTILE IRON CLASS 50, UNLESS OTHERWISE APPROVED BY THE CITY.
9. SANITARY SEWER PIPES SHALL NOT BE LOCATED UNDER ANY STRUCTURE (WALL, BUILDING FOUNDATION, ETC.) UNLESS APPROVED BY THE CITY. IF A SANITARY SEWER IS TO BE LOCATED UNDER ANY STRUCTURE (WALL, BUILDING FOUNDATION, ETC.), IT SHALL BE ENCASED IN A STEEL CASING THAT EXTENDS A MINIMUM OF 5 FEET OUTSIDE OF SAID STRUCTURE. STEEL CASINGS SHALL BE DESIGNED BY A PROFESSIONAL ENGINEER LICENSED IN THE STATE OF WASHINGTON AND SHALL HAVE A 3/8-INCH MINIMUM WALL THICKNESS AND SHALL BE OF SUFFICIENT SIZE TO ALLOW INSTALLATION OF THE SANITARY SEWER PIPE WHILE MAINTAINING CLEARANCES AS RECOMMENDED BY THE CASING SPACER MANUFACTURER. STAINLESS STEEL CASING SPACERS SHALL BE INSTALLED ON THE SANITARY SEWER PIPE AT DISTANCES THAT PROVIDE ADEQUATE SUPPORT TO PREVENT SAGGING. THE ENDS OF CASINGS SHALL BE SEALED WITH WRAP-AROUND FLEXIBLE END SEALS.
10. OPEN-CUT ROAD CROSSINGS FOR UTILITY TRENCHES ON EXISTING TRAVELED ROADWAYS SHALL BE BACKFILLED WITH CRUSHED SURFACING AGGREGATE (WSDOT SPECIFICATION 9-03.9(3) AND MECHANICALLY COMPACTED UNLESS OTHERWISE APPROVED BY THE CITY.
11. ALL PIPE AND APPURTENANCES SHALL BE LAID ON A PROPERLY PREPARED FOUNDATION IN ACCORDANCE WITH THE STANDARDS AND SPECIFICATION OF THE CITY AND THE LATEST EDITION OF THE WSDOT/APWA STANDARDS AND SPECIFICATION AS APPROVED AND MODIFIED BY THE CITY IN THE RENTON STANDARD PLANS & SPECIFICATIONS. THIS SHALL INCLUDE NECESSARY LEVELING OF THE TRENCH BOTTOM OR THE TOP OF THE FOUNDATION MATERIAL TO A UNIFORM GRADE SO THAT THE ENTIRE LENGTH OF THE PIPE WILL BE SUPPORTED ON A UNIFORMLY DENSE, UNYIELDING BASE. PIPE BEDDING SHALL BE IN ACCORDANCE WITH STANDARD PLAN 405.
12. ALL DISTURBED AREAS SHALL BE SEEDED AND MULCHED OR OTHERWISE STABILIZED TO THE SATISFACTION OF THE CITY FOR THE PREVENTION OF ON-SITE EROSION BOTH DURING CONSTRUCTION AND AFTER THE COMPLETION OF CONSTRUCTION IN ACCORDANCE WITH THE CURRENT SURFACE WATER DESIGN MANUAL.
13. THE CONTRACTOR SHALL PROVIDE THE CITY OF RENTON WITH A RECORD DRAWING OF THE SANITARY SEWER SYSTEM WHICH HAS BEEN STAMPED AND SIGNED BY A LICENSED PROFESSIONAL ENGINEER OR LICENSED PROFESSIONAL SURVEYOR.



PUBLIC WORKS
DEPARTMENT

**WASTEWATER UTILITY
STANDARD NOTES**

STD. PLAN - 413

APPROVED:

Gregg Zimmerman
Public Works Administrator

DATE

Appendix K

CIP DETAIL SHEETS

City of Renton
Long-Range Wastewater Management Plan
Capital Improvement Program



Capital Improvement Program Summary (Current Dollars)			
Project Type	CIP Phasing		Total CIP Cost Estimate
	Short-term (2020-2025)	Long-term (2030-2039)	
Cross Category	\$ 9,350,000	\$ 630,000	\$ 9,980,000
Maintenance	\$ 14,740,000	\$ 49,470,000	\$ 64,210,000
Planning	\$ 2,880,000	\$ 2,000,000	\$ 4,880,000
Total Cost	\$ 26,970,000	\$ 52,100,000	\$ 96,870,000
Annual Cost	\$ 4,495,000	\$ 5,210,000	\$ 4,844,000

Capital Improvement Projects	
Project ID	Project Name
Pump Station	
LS-01	Lift Station Rehabilitation
LS-02	Forcemain Rehabilitation/Replacement
LS-03	Telemetry Upgrade
LS-04	Devil's Elbow Stream Bank Study
LS-05	Kennydale Lakeline Sewer Upgrade
LS-06	Kennydale Lakeline Renewal
LS-07	Low and Moderately-Low Risk Lift Station and FM Rehabilitation
LS-08	Moderately-High and High Risk Lift Station and FM Rehabilitation
Pipeline	
P-01	2020 Sanitary Sewer Main Replacement/Rehabilitation
P-02	2021 Sanitary Sewer Main Replacement/Rehabilitation
P-03	2022 Sanitary Sewer Main Replacement/Rehabilitation
P-04	2023 Sanitary Sewer Main Replacement/Rehabilitation
P-05	2024 Sanitary Sewer Main Replacement/Rehabilitation
P-06	2025 Sanitary Sewer Main Replacement/Rehabilitation
P-07	2026-2029 Sanitary Sewer Main Replacement/Rehabilitation
P-08	2030-2039 Sanitary Sewer Main Replacement/Rehabilitation
P-09	Sewer Capacity Improvements
P-10	Flow Monitoring Program
P-11	I/I Evaluation Program
General	
G-01	Wastewater Operations Master Plan
G-02	Long-Range Wastewater Management Plan
G-03	Sanitary Sewer Hydraulic Model
G-04	Miscellaneous/Emergency Projects

Cost by Project Category

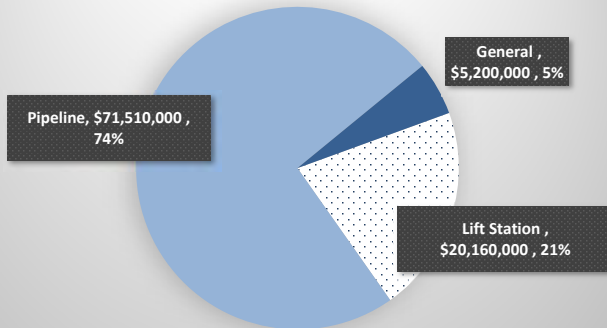

Lift Station	\$20,160,000	21%
Pipeline	\$71,510,000	74%
General	\$5,200,000	5%
Total	\$96,870,000	100%

Short-Term		
Lift Station	\$3,480,000	13%
Pipeline	\$21,090,000	78%
General	\$2,400,000	9%
Total	\$26,970,000	100%

Long-Term		
Lift Station	\$14,110,000	37%
Pipeline	\$35,990,000	9%
General	\$2,000,000	8%
Total	\$52,100,000	100%

Cost by Project Category (Short-Term)

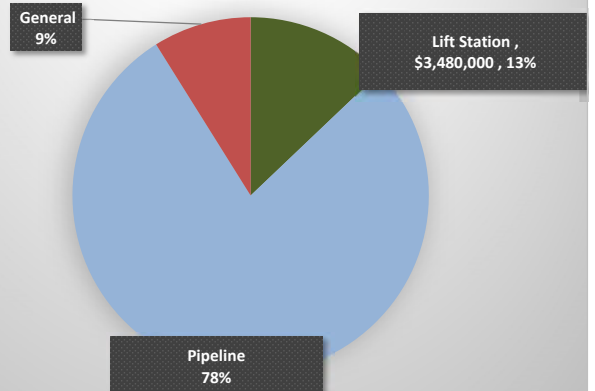

Cost by Project Category (Long-Term)

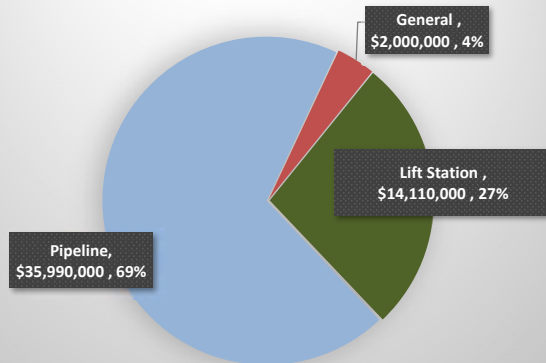

City of Renton
Long-Range Wastewater Management Plan
Capital Improvement Program (Current Dollars)



Capital Improvement Program Summary (Current Dollars)

Project	Enter Cost Type Here: Current Dollars	Total CIP Cost Estimate	CIP Phasing (Current Dollars)										Short-term (2020-2025)	Medium-term (2026-2029)	Long-term (2030-2039)
			2020	2021	2022	2023	2024	2025	2026	2027	2028	2029			
Pump Stations		\$20,160,000	\$3,000,000	\$180,000	\$0	\$300,000	\$0	\$0	\$650,000	\$640,000	\$640,000	\$640,000	\$3,480,000	\$2,570,000	\$14,110,000
LS-01	Lift Station Rehabilitation	\$900,000	\$900,000	\$0	\$0	\$0	\$0	\$0	\$0	\$0	\$0	\$0	\$900,000	\$0	\$0
LS-02	Forcemain Rehabilitation/Replacement	\$400,000	\$400,000	\$0	\$0	\$0	\$0	\$0	\$0	\$0	\$0	\$0	\$400,000	\$0	\$0
LS-03	Telemetry Upgrade	\$300,000	\$0	\$0	\$300,000	\$0	\$0	\$0	\$0	\$0	\$0	\$0	\$300,000	\$0	\$0
LS-04	Devil's Elbow Stream Bank Study	\$180,000	\$0	\$180,000	\$0	\$0	\$0	\$0	\$0	\$0	\$0	\$0	\$180,000	\$0	\$0
LS-05	Kennydale Lakeline Sewer Upgrade	\$1,700,000	\$1,700,000	\$0	\$0	\$0	\$0	\$0	\$0	\$0	\$0	\$0	\$1,700,000	\$0	\$0
LS-06	Kennydale Lakeline Renewal	\$8,000,000	\$0	\$0	\$0	\$0	\$0	\$0	\$0	\$0	\$0	\$0	\$0	\$0	\$8,000,000
LS-07	Low and Moderately-Low Risk Lift Station and FM Rehabilitation	\$6,110,000	\$0	\$0	\$0	\$0	\$0	\$0	\$0	\$0	\$0	\$0	\$0	\$0	\$6,110,000
LS-08	Moderately-High and High Risk Lift Station and FM Rehabilitation	\$2,570,000	\$0	\$0	\$0	\$0	\$0	\$0	\$650,000	\$640,000	\$640,000	\$640,000	\$0	\$2,570,000	\$0
Pipelines		\$71,510,000	\$1,500,000	\$3,450,000	\$4,830,000	\$3,780,000	\$3,720,000	\$3,810,000	\$3,810,000	\$3,540,000	\$3,540,000	\$3,540,000	\$21,090,000	\$14,430,000	\$35,990,000
P-01	2020 Sanitary Sewer Main Replacement/Rehabilitation	\$1,500,000	\$1,500,000	\$0	\$0	\$0	\$0	\$0	\$0	\$0	\$0	\$0	\$1,500,000	\$0	\$0
P-02	2021 Sanitary Sewer Main Replacement/Rehabilitation	\$2,000,000	\$0	\$2,000,000	\$0	\$0	\$0	\$0	\$0	\$0	\$0	\$0	\$2,000,000	\$0	\$0
P-03	2022 Sanitary Sewer Main Replacement/Rehabilitation	\$2,000,000	\$0	\$0	\$2,000,000	\$0	\$0	\$0	\$0	\$0	\$0	\$0	\$2,000,000	\$0	\$0
P-04	2023 Sanitary Sewer Main Replacement/Rehabilitation	\$2,000,000	\$0	\$0	\$0	\$2,000,000	\$0	\$0	\$0	\$0	\$0	\$0	\$2,000,000	\$0	\$0
P-05	2024 Sanitary Sewer Main Replacement/Rehabilitation	\$2,000,000	\$0	\$0	\$0	\$0	\$2,000,000	\$0	\$0	\$0	\$0	\$0	\$2,000,000	\$0	\$0
P-06	2025 Sanitary Sewer Main Replacement/Rehabilitation	\$3,540,000	\$0	\$0	\$0	\$0	\$0	\$3,540,000	\$0	\$0	\$0	\$0	\$3,540,000	\$0	\$0
P-07	2026-2029 Sanitary Sewer Main Replacement/Rehabilitation	\$14,160,000	\$0	\$0	\$0	\$0	\$0	\$0	\$3,540,000	\$3,540,000	\$3,540,000	\$3,540,000	\$0	\$14,160,000	\$0
P-08	2030-2039 Sanitary Sewer Main Replacement/Rehabilitation	\$35,360,000	\$0	\$0	\$0	\$0	\$0	\$0	\$0	\$0	\$0	\$0	\$0	\$0	\$35,360,000
P-09	Sewer Capacity Improvements	\$5,800,000	\$0	\$1,450,000	\$1,450,000	\$1,450,000	\$1,450,000	\$0	\$0	\$0	\$0	\$0	\$5,800,000	\$0	\$0
P-10	Flow Monitoring Program	\$1,470,000	\$0	\$0	\$330,000	\$330,000	\$270,000	\$270,000	\$270,000	\$0	\$0	\$0	\$1,200,000	\$270,000	\$0
P-11	I/I Evaluation Program	\$1,680,000	\$0	\$0	\$1,050,000	\$0	\$0	\$0	\$0	\$0	\$0	\$0	\$1,050,000	\$0	\$630,000
General		\$5,200,000	\$500,000	\$500,000	\$500,000	\$200,000	\$500,000	\$200,000	\$200,000	\$200,000	\$200,000	\$200,000	\$2,400,000	\$800,000	\$2,000,000
G-01	Wastewater Operations Master Plan	\$300,000	\$300,000	\$0	\$0	\$0	\$0	\$0	\$0	\$0	\$0	\$0	\$300,000	\$0	\$0
G-02	Long-Range Wastewater Management Plan	\$300,000	\$0	\$0	\$0	\$0	\$300,000	\$0	\$0	\$0	\$0	\$0	\$300,000	\$0	\$0
G-03	Sanitary Sewer Hydraulic Model	\$600,000	\$0	\$300,000	\$300,000	\$0	\$0	\$0	\$0	\$0	\$0	\$0	\$600,000	\$0	\$0
G-04	Miscellaneous/Emergency Projects	\$4,000,000	\$200,000	\$200,000	\$200,000	\$200,000	\$200,000	\$200,000	\$200,000	\$200,000	\$200,000	\$200,000	\$1,200,000	\$800,000	\$2,000,000
CIP Total (Current Dollars)		\$96,870,000	\$5,000,000	\$4,130,000	\$5,330,000	\$4,280,000	\$4,220,000	\$4,010,000	\$4,660,000	\$4,380,000	\$4,380,000	\$4,380,000	\$26,970,000	\$17,800,000	\$52,100,000
Annual Cost (Current Dollars)		\$4,844,000	\$5,000,000	\$4,130,000	\$5,330,000	\$4,280,000	\$4,220,000	\$4,010,000	\$4,660,000	\$4,380,000	\$4,380,000	\$4,380,000	\$4,495,000	\$4,450,000	\$5,210,000

City of Renton
Long-Range Wastewater Management Plan
Capital Improvement Program



Cost Estimate Assumptions

Notes:

- 1 All costs are in 2019 dollars. Cost estimate made in: 2020
- 2 Engineering News Report (ENR) U.S. 20-City Construction Cost Index for July 2019 is 11293
- 3 Cost estimates do not include costs for easements or ROW acquisition.
- 4 Cost estimates per foot of pipe before contingencies are as follows:
- 5 Allowances are used based upon planning level budgeting. Estimates will be refined based on subsequent studies
- 6 To update costs for inflation to future value, insert inflation rate here: 3%
- 7 When considering cost inflation for long-term projects, timing is assumed to be 15 years from current date.

Gravity Sewer Unit Costs

Pipe Diameter	Value	Unit	Notes
6"	\$330	LF	15' depth
8"	\$341	LF	15' depth
10"	\$352	LF	15' depth
12"	\$363	LF	15' depth
14"	\$374	LF	15' depth
16"	\$385	LF	15' depth
18"	\$396	LF	15' depth
24"	\$407	LF	15' depth

CIPP Costs

Pipe Diameter	Value	Unit	Notes
6"	\$52.80	LF	
8"	\$70.40	LF	
10"	\$88.00	LF	
12"	\$105.60	LF	
14"	\$123.20	LF	
16"	\$140.80	LF	
18"	\$158.40	LF	
21"	\$184.80	LF	
24"	\$211.20	LF	

Force Main Cleaning

Parameter	Cost	Unit	Notes
Force Main Rehab/Replacement	\$ 119,895	FM	

Lift Station Unit Costs

Parameter	Cost	Unit	Notes
Low to Moderately-Low R&R	\$ 138,400	LS	
High to Moderately-High R&R	\$ 138,400	LS	City price may differ

City of Renton
Long-Range Wastewater Management Plan
Capital Improvement Program



Cost Estimate Assumptions

Monitoring Costs

	Cost	Unit	Notes
I&I Micro-Monitoring	\$ 5,000	meter/month	
Depth Monitoring	\$ 2,000	meter/month	
Condition Assessment	\$ 10	LF	

Adjustment Factors

	Notes
City Admin	10%
Design	20%
Construction	10%
Scope Contingency	30%

Level Five Cost Estimate Disclaimer:

The cost estimates within this CIP tool are based on our perception of current conditions at the project location. This estimate reflects our professional opinion of accurate costs at this time and is subject to change as the project design matures. Carollo Engineers, Inc. has no control over variances in the cost of labor, materials, equipment; nor services provided by others, contractor's means and methods of executing the work or of determining prices, competitive bidding or market conditions, practices or bidding strategies. Carollo Engineers cannot and does not warrant or

City of Renton
Long-Range Wastewater Master Plan
Capital Improvement Program



Project ID:	LS-01	Project Cost (Current \$):	\$ 900,000
Project Name:	Lift Station Rehabilitation	Project Cost (Future \$):	\$ 900,000
Facility Type:	Lift Station	Project Timing:	2020 to 2020
Developer Share:		Inflation Rate:	3%

[Go to CIP Summary](#)

Project Description:

The Wastewater Utility operates 20 lift stations throughout the City. At this point, the City is going into the maintenance/rehabilitation phase for each of the stations. In 2016, the City completed the process of evaluating the needs for each station. The second phase of full rehabilitation of lift stations began in 2017 and will be completed in 2020. The cost for this has been reported by the City at \$0.9 M in 2020.

Project Cost Estimate (Current \$):

Project Element	Quantity	Unit	Unit Cost (\$/Unit)	Subtotal	City Admin	Design	Construction	Scope Contingency	Total Cost (Current \$)
					10%	20%	10%	30%	
Lift Station Rehabilitation	1	LS	\$ 900,000	\$ 900,000					\$ 900,000

Total Project Cost (Current \$)	\$ 900,000
--	-------------------

Notes on Cost Estimation:

Based on the pipe cost per linear foot assumptions found on the "Assumptions" tab.

[Go to Assumptions Tab](#)

City of Renton
 Long-Range Wastewater Master Plan
 Capital Improvement Program



Project ID:	LS-01	Project Cost (Current \$):	\$ 900,000
Project Name:	Lift Station Rehabilitation	Project Cost (Future \$):	\$ 900,000
Facility Type:	Lift Station	Project Timing:	2020 to 2020
Developer Share:	0	Inflation Rate:	3%

[Go to CIP Summary](#)

Cost Allocation:

Project Type	Percent	Cost
Capacity:	100%	\$ 900,000
R&R:	0%	\$ -
General Programmatic	0%	\$ -
Total Project Cost	100%	\$ 900,000

Project Timing:

Project Element	Timing	Project Cost (Current \$)	Project Cost (Future \$)
Lift Station Rehabilitation	2020	\$ 900,000	\$ 900,000
		\$ -	\$ -
		\$ -	\$ -
Total Project Cost		\$ 900,000	\$ 900,000

Project Location:

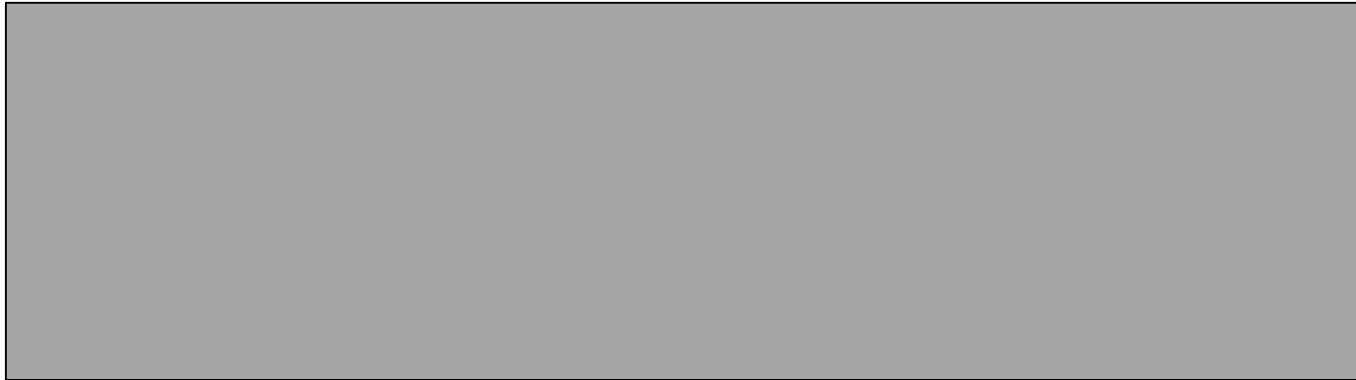

Notes:

See full map on "Maps" tab.

City of Renton
Long-Range Wastewater Master Plan
Capital Improvement Program



Project ID:	LS-02	Project Cost (Current \$):	\$ 400,000
Project Name:	Forcemain Rehabilitation/Replacement	Project Cost (Future \$):	\$ 400,000
Facility Type:	Lift Station	Project Timing:	2020 to 2020
Developer Share:		Inflation Rate:	3%

[Go to CIP Summary](#)

Project Description:

The Wastewater Utility operates lift stations that each have their own FM that delivers the flow to the gravity system. While many of the lift stations have been either rehabilitated or replaced, their FMs often times were not. In 2016, a FM evaluation was completed that prioritized FMs. The replacement and rehabilitation of FMs identified began in 2016 and will be complete in 2020. The estimated cost is \$400,000 in 2020.

Project Cost Estimate (Current \$):

Project Element	Quantity	Unit	Unit Cost (\$/Unit)	Subtotal	City Admin	Design	Construction	Scope Contingency	Total Cost (Current \$)
					10%	20%	10%	30%	
Forcemain Rehabilitation/Replacement	1		\$ 400,000	\$ 400,000					\$ 400,000

Total Project Cost (Current \$)	\$ 400,000
--	------------

Notes on Cost Estimation:

Based on the pipe cost per linear foot assumptions found on the "Assumptions" tab.

[Go to Assumptions Tab](#)

**City of Renton
Long-Range Wastewater Master Plan
Capital Improvement Program**



Project ID:	LS-02	Project Cost (Current \$):	\$ 400,000
Project Name:	Forcemain Rehabilitation/Replacement	Project Cost (Future \$):	\$ 400,000
Facility Type:	Lift Station	Project Timing:	2020 to 2020
Developer Share:	0	Inflation Rate:	3%

[Go to CIP Summary](#)

Cost Allocation:

Project Type	Percent	Cost
Capacity:	100%	\$ 400,000
R&R:	0%	\$ -
General Programmatic	0%	\$ -
Total Project Cost	100%	\$ 400,000

Project Timing:

Project Element	Timing	Project Cost (Current \$)	Project Cost (Future \$)
Forcemain Rehabilitation/Replacement	2020	\$ 400,000	\$ 400,000
		\$ -	\$ -
		\$ -	\$ -
Total Project Cost		\$ 400,000	\$ 400,000

Project Location:

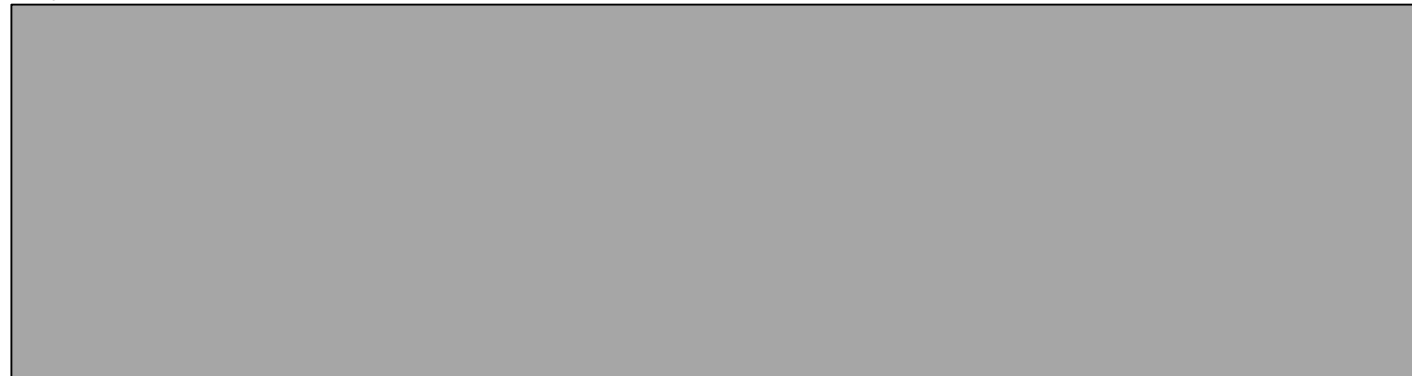

Notes:

See full map on "Maps" tab.

City of Renton
Long-Range Wastewater Master Plan
Capital Improvement Program



Project ID:	LS-03	Project Cost (Current \$):	\$ 300,000
Project Name:	Telemetry Upgrade	Project Cost (Future \$):	\$ 327,818
Facility Type:	Lift Station	Project Timing:	2023 to 2023
Developer Share:		Inflation Rate:	3%

[Go to CIP Summary](#)

Project Description:

The telemetry and control system records and stores flow rates and alarms for each lift station, which is then monitored in a Supervisory Control and Data Acquisition (SCADA) system. SCADA can then be accessed by the operations and maintenance (O&M) team, as well as engineers, to help the City monitor infrastructure. This system occasionally experiences communication and other issues that result in data errors which can be critical at times. Automatically generated reports are a benefit of the updated SCADA. It is currently anticipated that the system will be updated every five years. The cost for this has been reported by the City to be \$300,000 and is planned for 2023.

Project Cost Estimate (Current \$):

Project Element	Quantity	Unit	Unit Cost (\$/Unit)	Subtotal	City Admin	Design	Construction	Scope Contingency	Total Cost (Current \$)
					10%	20%	10%	30%	
Telemetry Upgrade	1		\$ 300,000	\$ 300,000					\$ 300,000

Total Project Cost (Current \$)	\$ 300,000
--	------------

Notes on Cost Estimation:

Based on the pipe cost per linear foot assumptions found on the "Assumptions" tab.

[Go to Assumptions Tab](#)

City of Renton
Long-Range Wastewater Master Plan
Capital Improvement Program



Project ID:	LS-03	Project Cost (Current \$):	\$ 300,000
Project Name:	Telemetry Upgrade	Project Cost (Future \$):	\$ 327,818
Facility Type:	Lift Station	Project Timing:	2023 to 2023
Developer Share:	0	Inflation Rate:	3%

[Go to CIP Summary](#)

Cost Allocation:

Project Type	Percent	Cost
Cross Category	0%	\$ -
Maintenance	0%	\$ -
Planning	100%	\$ 300,000
Total Project Cost	100%	\$ 300,000

Project Timing:

Project Element	Timing	Project Cost (Current \$)	Project Cost (Future \$)
Telemetry Upgrade	2023	\$ 300,000	\$ 327,818
		\$ -	\$ -
		\$ -	\$ -
Total Project Cost		\$ 300,000	\$ 327,818

Project Location:

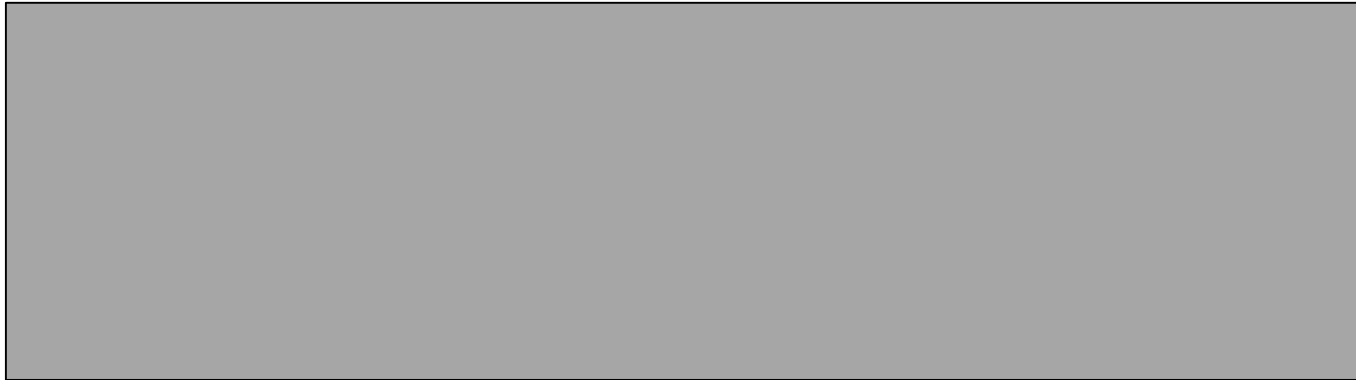

Notes:

See full map on "Maps" tab.

City of Renton
Long-Range Wastewater Master Plan
Capital Improvement Program



Project ID:	LS-04	Project Cost (Current \$):	\$ 182,000
Project Name:	Devil's Elbow Stream Bank Study	Project Cost (Future \$):	\$ 187,460
Facility Type:	Lift Station	Project Timing:	2021 to 2021
Developer Share:		Inflation Rate:	3%

[Go to CIP Summary](#)

Project Description:

It is recommended that the City monitor the condition of stream banks adjacent to the Devil's Elbow lift station and evaluate alternatives to armor the bank to protect the lift station and FM. The timing for this project is recommended to be completed in the short-term. The FM length is 506 LF with 6 inch diameter. The Level 5 AACE estimated cost for this project is \$180,000 in the short-term.

Project Cost Estimate (Current \$):

Project Element	Quantity	Unit	Unit Cost (\$/Unit)	Subtotal	City Admin	Design	Construction	Scope Contingency	Total Cost (Current \$)
					10%	20%	10%	30%	
Devil's Elbow Stream Bank Study	1		\$ 100,000	\$ 100,000	\$ 10,000	\$ 20,000	\$ 10,000	\$ 42,000	\$ 182,000

Total Project Cost (Current \$) \$ 182,000

Notes on Cost Estimation:

Based on the pipe cost per linear foot assumptions found on the "Assumptions" tab.

[Go to Assumptions Tab](#)

City of Renton
 Long-Range Wastewater Master Plan
 Capital Improvement Program



Project ID:	LS-04	Project Cost (Current \$):	\$ 182,000
Project Name:	Devil's Elbow Stream Bank Study	Project Cost (Future \$):	\$ 187,460
Facility Type:	Lift Station	Project Timing:	2021 to 2021
Developer Share:	0	Inflation Rate:	3%

[Go to CIP Summary](#)

Cost Allocation:

Project Type	Percent	Cost
Cross Category	0%	\$ -
Maintenance	0%	\$ -
Planning	100%	\$ 182,000
Total Project Cost	100%	\$ 182,000

Project Timing:

Project Element	Timing	Project Cost (Current \$)	Project Cost (Future \$)
Devil's Elbow Stream Bank Study	2021	\$ 182,000	\$ 187,460
		\$ -	\$ -
		\$ -	\$ -
Total Project Cost		\$ 182,000	\$ 187,460

Project Location:



Notes:

See full map on "Maps" tab.

City of Renton
Long-Range Wastewater Master Plan
Capital Improvement Program



Project ID:	LS-05	Project Cost (Current \$):	\$ 1,700,000
Project Name:	Kennydale Lakeline Sewer Upgrade	Project Cost (Future \$):	\$ 1,700,000
Facility Type:	Lift Station	Project Timing:	2020 to 2020
Developer Share:		Inflation Rate:	3%

[Go to CIP Summary](#)

Project Description:

The Kennydale Lake Line Sewer System Improvement Project will allow long-term operation of the system. This program includes design and construction of a preferred alternative: 1. Lake Line System rehabilitation and repair or 2. Replacement with Individual Lift Stations. The City has budgeted a total of \$1.7 M for 2019 and \$1.7 M for 2020 for a total of \$3.4 M for this effort.

Project Cost Estimate (Current \$):

Project Element	Quantity	Unit	Unit Cost (\$/Unit)	Subtotal	City Admin	Design	Construction	Scope Contingency	Total Cost (Current \$)
					10%	20%	10%	30%	
Kennydale Lakeline Sewer Upgrade	1	P	\$ 1,700,000	\$ 1,700,000	-	-	-	-	\$ 1,700,000

Total Project Cost (Current \$)	\$ 1,700,000
--	---------------------

Notes on Cost Estimation:

Based on the pipe cost per linear foot assumptions found on the "Assumptions" tab.

[Go to Assumptions Tab](#)

**City of Renton
Long-Range Wastewater Master Plan
Capital Improvement Program**



Project ID:	LS-05	Project Cost (Current \$):	\$ 1,700,000
Project Name:	Kennydale Lakeline Sewer Upgrade	Project Cost (Future \$):	\$ 1,700,000
Facility Type:	Lift Station	Project Timing:	2020 to 2020
Developer Share:	0	Inflation Rate:	3%

[Go to CIP Summary](#)

Cost Allocation:

Project Type	Percent	Cost
Cross Category	0%	\$ -
Maintenance	100%	\$ 1,700,000
Planning	0%	\$ -
Total Project Cost	100%	\$ 1,700,000

Project Timing:

Project Element	Timing	Project Cost (Current \$)	Project Cost (Future \$)
Kennydale Lakeline Sewer Upgrade	2020	\$ 1,700,000	\$ 1,700,000
		\$ -	\$ -
		\$ -	\$ -
Total Project Cost		\$ 1,700,000	\$ 1,700,000

Project Location:

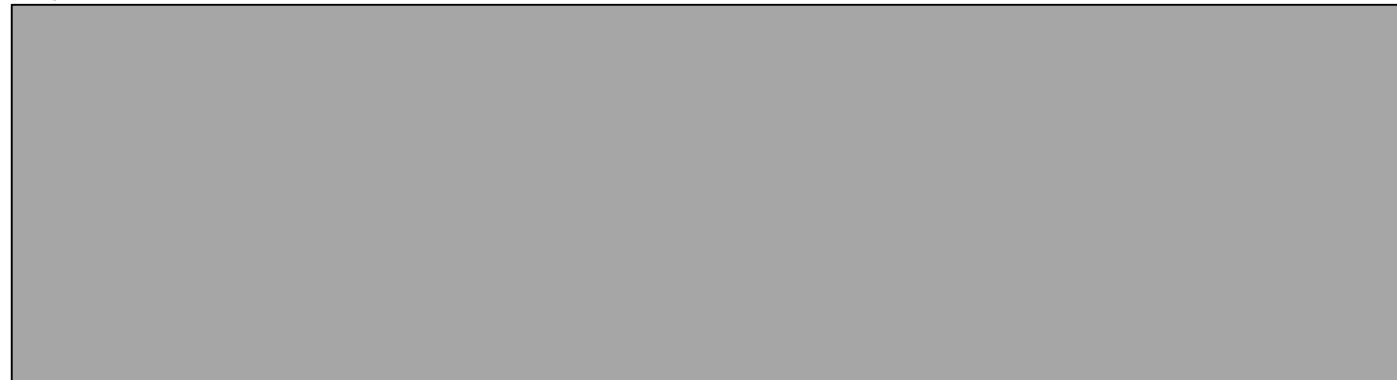

Notes:

See full map on "Maps" tab.

City of Renton
Long-Range Wastewater Master Plan
Capital Improvement Program



Project ID:	LS-06	Project Cost (Current \$):	\$ 8,000,000
Project Name:	Kennydale Lakeline Renewal	Project Cost (Future \$):	\$12,463,739
Facility Type:	Lift Station	Project Timing:	Long-term
Developer Share:		Inflation Rate:	3%

[Go to CIP Summary](#)

Project Description:

The Kennydale Lake Line Sewer System Evaluation identified multiple options for the replacing the system at the end of its usable life. For budgetary purposes, the least expensive option, Individual Lift Stations, for \$8 M will be budgeted in the long-term. For additional details, see the 2019 Kennydale Lake Line Sewer System Evaluation Phase 2B and 3 Summary Report.

Project Cost Estimate (Current \$):

Project Element	Quantity	Unit	Unit Cost (\$/Unit)	Subtotal	City Admin	Design	Construction	Scope Contingency	Total Cost (Current \$)
					10%	20%	10%	30%	
Kennydale Lakeline Renewal	1		\$ 8,000,000	\$ 8,000,000					\$ 8,000,000

Total Project Cost (Current \$)	\$ 8,000,000
--	---------------------

Notes on Cost Estimation:

Based on the pipe cost per linear foot assumptions found on the "Assumptions" tab.

[Go to Assumptions Tab](#)

**City of Renton
Long-Range Wastewater Master Plan
Capital Improvement Program**



Project ID:	LS-06	Project Cost (Current \$):	\$ 8,000,000
Project Name:	Kennydale Lakeline Renewal	Project Cost (Future \$):	\$ 12,463,739
Facility Type:	Lift Station	Project Timing:	Long-term
Developer Share:	0	Inflation Rate:	3%

[Go to CIP Summary](#)

Cost Allocation:

Project Type	Percent	Cost
Cross Category	0%	\$ -
Maintenance	100%	\$ 8,000,000
Planning	0%	\$ -
Total Project Cost	100%	\$ 8,000,000

Project Timing:

Project Element	Timing	Project Cost (Current \$)	Project Cost (Future \$)
Kennydale Lakeline Renewal	Long-term	\$ 2,666,667	\$ 4,154,580
Kennydale Lakeline Renewal	Long-term	\$ 2,666,667	\$ 4,154,580
Kennydale Lakeline Renewal	Long-term	\$ 2,666,667	\$ 4,154,580
Total Project Cost		\$ 8,000,000	\$ 12,463,739

Project Location:



Notes:

See full map on "Maps" tab.

City of Renton
Long-Range Wastewater Master Plan
Capital Improvement Program



Project ID:	LS-07	Project Cost (Current \$):	\$ 6,111,253
Project Name:	Low and Moderately-Low Risk Lift Station and FM Rehabilitation	Project Cost (Future \$):	\$ 9,521,134
Facility Type:	Lift Station	Project Timing:	Long-term
Developer Share:		Inflation Rate:	3%

[Go to CIP Summary](#)

Project Description:

This project addresses long-term renewal needs for existing facilities. Lift stations and FMs in the moderately-low to low risk categories are recommended to be evaluated for rehabilitation in the long-term, which are listed in Table 8.4. The recommended rehabilitation is consistent with the City's historical Lift Station rehabilitation schedule.

Project Cost Estimate (Current \$):

Project Element	Quantity	Unit	Unit Cost (\$/Unit)	Subtotal	City Admin	Design	Construction	Scope Contingency	Total Cost (Current \$)
					10%	20%	10%	30%	
Lift Station Rehabilitation	13	LS	\$ 138,400	\$ 1,799,200	\$ 179,920	\$ 359,840	\$ 179,920	\$ 755,664	\$ 3,274,544
FM Rehabilitaton/Replacement	13	FM	\$ 119,895	\$ 1,558,632	\$ 155,863	\$ 311,726	\$ 155,863	\$ 654,625	\$ 2,836,709

Total Project Cost (Current \$)	\$ 6,111,253
--	--------------

Notes on Cost Estimation:

Based on the pipe cost per linear foot assumptions found on the "Assumptions" tab.

[Go to Assumptions Tab](#)

**City of Renton
Long-Range Wastewater Master Plan
Capital Improvement Program**



Project ID:	LS-07	Project Cost (Current \$):	\$ 6,111,253
Project Name:	Low and Moderately-Low Risk Lift Station and FM Rehabilitation	Project Cost (Future \$):	\$ 9,521,134
Facility Type:	Lift Station	Project Timing:	Long-term
Developer Share:	0	Inflation Rate:	3%

[Go to CIP Summary](#)

Cost Allocation:

Project Type	Percent	Cost
Cross Category	0%	\$ -
Maintenance	100%	\$ 6,111,253
Planning	0%	\$ -
Total Project Cost	100%	\$ 6,111,253

Project Timing:

Project Element	Timing	Project Cost (Current \$)	Project Cost (Future \$)
Lift Station Rehabilitation	Long-term	\$ 3,274,544	\$ 5,101,633
FM Rehabilitaton/Replacement	Long-term	\$ 2,836,709	\$ 4,419,501
Total Project Cost		\$ 6,111,253	\$ 9,521,134

Project Location:



Notes:
See full map on "Maps" tab.

**City of Renton
Long-Range Wastewater Master Plan
Capital Improvement Program**



Project ID:	LS-08	Project Cost (Current \$):	\$ 2,568,691
Project Name:	Moderately-High and High Risk Lift Station and FM Rehabilitation	Project Cost (Future \$):	\$ 8,110
Facility Type:	Lift Station	Project Timing:	2026 to 2029
Developer Share:		Inflation Rate:	3%

[Go to CIP Summary](#)

Project Description:

Lift stations and FMs that are moderately-high to high risk are recommended for rehabilitation in the long-term, which are listed in Table 8.5. The recommended rehabilitation is consist with the City's historical Lift Station rehabilitation schedule. These stations are the Talbot Crest, Long, Wedgewood, Devil's Elbow, and Kensington Crest. Estimated cost of lift station rehabilitation is \$1.26 M in the short term and medium term and \$1.31 M in the long term for a total of \$2.57 M. This does not include the rehabilitation of Lake WA No. 1 and Lake WA Flush Stations.

Project Cost Estimate (Current \$):

Project Element	Quantity	Unit	Unit Cost (\$/Unit)	Subtotal	City Admin	Design	Construction	Scope Contingency	Total Cost (Current \$)
					10%	20%	10%	30%	
Lift Station Rehabilitation	5	LS	\$ 138,400	\$ 692,000	\$ 69,200	\$ 138,400	\$ 69,200	\$ 290,640	\$ 1,259,440
FM Rehabilitation/Replacement	6	LF	\$ 119,895	\$ 719,368	\$ 71,937	\$ 143,874	\$ 71,937	\$ 302,135	\$ 1,309,251
Total Project Cost (Current \$)									\$ 2,568,691

Notes on Cost Estimation:

Based on the pipe cost per linear foot assumptions found on the "Assumptions" tab.

[Go to Assumptions Tab](#)

**City of Renton
Long-Range Wastewater Master Plan
Capital Improvement Program**



Project ID:	LS-08	Project Cost (Current \$):	\$ 2,568,691
Project Name:	Moderately-High and High Risk Lift Station and FM Rehabilitation	Project Cost (Future \$):	\$ 8,110
Facility Type:	Lift Station	Project Timing:	2026 to 2029
Developer Share:	0	Inflation Rate:	3%

[Go to CIP Summary](#)

Cost Allocation:

Project Type	Percent	Cost
Cross Category	0%	\$ -
Maintenance	100%	\$ 2,568,691
Planning	0%	\$ -

Total Project Cost	100% \$ 2,568,691
---------------------------	-------------------

Project Timing:

Project Element	Timing	Project Cost (Current \$)	Project Cost (Future \$)
Lift Station Rehabilitation	2026	\$ 642,173	\$ 2,026
Lift Station Rehabilitation	2027	\$ 642,173	\$ 2,027
Lift Station Rehabilitation	2028	\$ 642,173	\$ 2,028
Lift Station Rehabilitation	2029	\$ 642,173	\$ 2,029

Total Project Cost	\$ 2,568,691	\$ 8,110
---------------------------	--------------	----------

Project Location:



Notes:

See full map on "Maps" tab.

**City of Renton
Long-Range Wastewater Master Plan
Capital Improvement Program**



Project ID: **Project Cost (Current \$):** \$ -
Project Name: Rehabilitation Program **Project Cost (Future \$):** \$ -
Facility Type: Pipe **Project Timing:** Long-term
Developer Share: **Inflation Rate:** 3%

[Go to CIP Summary](#)

Project Description:

This project is used to identify the annual cost of the Sanitary Sewer Main Replacement and Rehabilitation Program on spreadsheets P-06 to P-08.

Project Cost Estimate (Current \$):

Project Element	Quantity	Unit	Unit Cost (\$/Unit)	Subtotal	City Admin	Design	Construction	Scope Contingency	Total Cost (Current \$)
					10%	20%	10%	30%	
6" High Risk Gravity Sewer Rehabilitation	1,432	LF	\$ 330	\$ 472,560	\$ 47,256	\$ 94,512	\$ 47,256	\$ 198,475	\$ 860,059
8" High Risk Gravity Sewer Rehabilitation	31,289	LF	\$ 341	\$ 10,669,549	\$ 1,066,955	\$ 2,133,910	\$ 1,066,955	\$ 4,481,211	\$ 19,418,579
10" High Risk Gravity Sewer Rehabilitation	1,759	LF	\$ 352	\$ 619,168	\$ 61,917	\$ 123,834	\$ 61,917	\$ 260,051	\$ 1,126,886
12" High Risk Gravity Sewer Rehabilitation	5,890	LF	\$ 363	\$ 2,138,070	\$ 213,807	\$ 427,614	\$ 213,807	\$ 897,989	\$ 3,891,287
14" High Risk Gravity Sewer Rehabilitation	2,490	LF	\$ 374	\$ 931,260	\$ 93,126	\$ 186,252	\$ 93,126	\$ 391,129	\$ 1,694,893
16" High Risk Gravity Sewer Rehabilitation	5,316	LF	\$ 385	\$ 2,046,660	\$ 204,666	\$ 409,332	\$ 204,666	\$ 859,597	\$ 3,724,921
18" High Risk Gravity Sewer Rehabilitation	2,151	LF	\$ 396	\$ 851,796	\$ 85,180	\$ 170,359	\$ 85,180	\$ 357,754	\$ 1,550,269
24" High Risk Gravity Sewer Rehabilitation	3,909	LF	\$ 407	\$ 1,590,963	\$ 159,096	\$ 318,193	\$ 159,096	\$ 668,204	\$ 2,895,553
6" Moderately-High Risk Gravity Sewer Rehabilitation	7,590	LF	\$ 53	\$ 400,752	\$ 40,075	\$ 80,150	\$ 40,075	\$ 168,316	\$ 729,369
8" Moderately-High Risk Gravity Sewer Rehabilitation	123,932	LF	\$ 70	\$ 8,724,778	\$ 872,478	\$ 1,744,956	\$ 872,478	\$ 3,664,407	\$ 15,879,095
10" Moderately-High Risk Gravity Sewer Rehabilitation	11,354	LF	\$ 88	\$ 999,108	\$ 99,911	\$ 199,822	\$ 99,911	\$ 419,625	\$ 1,818,377
12" Moderately-High Risk Gravity Sewer Rehabilitation	14,238	LF	\$ 106	\$ 1,503,480	\$ 150,348	\$ 300,696	\$ 150,348	\$ 631,462	\$ 2,736,334
14" Moderately-High Risk Gravity Sewer Rehabilitation	297	LF	\$ 123	\$ 36,590	\$ 3,659	\$ 7,318	\$ 3,659	\$ 15,368	\$ 66,595
16" Moderately-High Risk Gravity Sewer Rehabilitation	7,475	LF	\$ 141	\$ 1,052,480	\$ 105,248	\$ 210,496	\$ 105,248	\$ 442,042	\$ 1,915,514
18" Moderately-High Risk Gravity Sewer Rehabilitation	4,169	LF	\$ 158	\$ 660,290	\$ 66,029	\$ 132,058	\$ 66,029	\$ 277,322	\$ 1,201,729
21" Moderately-High Risk Gravity Sewer Rehabilitation	2,921	LF	\$ 185	\$ 539,708	\$ 53,971	\$ 107,942	\$ 53,971	\$ 226,678	\$ 982,269
24" Moderately-High Risk Gravity Sewer Rehabilitation	5,179	LF	\$ 211	\$ 1,093,699	\$ 109,370	\$ 218,740	\$ 109,370	\$ 459,354	\$ 1,990,533
Gravity Sewer Condition Assessment	2,935	LF	\$ 10	\$ 29,350	\$ 2,935	\$ 5,870	\$ 2,935	\$ 12,327	\$ 53,417

Total Project Cost (Current \$)	\$ 34,360,262		\$ 62,535,677
	\$ 29,964,658	2025 - 2039	\$ 53,035,677
	\$ 1,997,643.84		\$ 3,535,711.79

Notes on Cost Estimation:

Based on the pipe cost per linear foot assumptions found on the "Assumptions" tab. 50% of moderately-high risk pipes and 100% of high risk pipes are estimated to be replaced.

[Go to Assumptions Tab](#)

City of Renton
 Long-Range Wastewater Master Plan
 Capital Improvement Program



Project ID:

Project Cost (Current \$): \$ -

Project Name:

Rehabilitation Program

Project Cost (Future \$): \$ -

Facility Type:

Pipe

Project Timing: Long-term

Developer Share:

0

Inflation Rate: 3%

[Go to CIP Summary](#)

Cost Allocation:

Project Type	Percent	Cost
Cross Category	0%	\$ -
Maintenance	100%	\$ 62,535,677
Planning	0%	\$ -

Project Timing:

Project Element	Timing	Project Cost (Current \$)	Project Cost (Future \$)

Total Project Cost 100% \$ 62,535,677

Total Project Cost \$ - \$ -

Project Location:



Notes:

See full map on "Maps" tab.

**City of Renton
Long-Range Wastewater Master Plan
Capital Improvement Program**



Project ID:	P-01	Project Cost (Current \$):	\$ 1,500,000
Project Name:	2020 Sanitary Sewer Main Replacement/Rehabilitation	Project Cost (Future \$):	\$ 1,500,000
Facility Type:	Pipe	Project Timing:	2020 to 2020
Developer Share:		Inflation Rate:	3%

[Go to CIP Summary](#)

Project Description:

This is an annual program that is performed to identify and either repair, rehabilitate, or replace portions of sewer pipe that do not meet current standards. The program will be city-wide and may consist of individual projects. Similar to FMs and lift stations, a vulnerability and criticality analysis was conducted. RUL was determined for different pipe materials. For the CIP, pipes with RUL greater than 20 years were not considered. In order to confirm the condition of individual pipe's RUL, the City should conduct ongoing monitoring through CCTV inspections and tracking of point repairs and other maintenance issues. If the pipe has higher criticality or vulnerability, then a more advanced condition assessment may be required. This may include CCTV inspection, soil resistivity testing, pipe coupling, and other types of pipeline studies.

Project Cost Estimate (Current \$):

Project Element	Quantity	Unit	Unit Cost (\$/Unit)	Subtotal	City Admin	Design	Construction	Scope Contingency	Total Cost (Current \$)
					10%	20%	10%	30%	
2020 Sanitary Sewer Main Replacement/Rehabilitation	1	LF	\$ 1,500,000	\$ 1,500,000					\$ 1,500,000

Total Project Cost (Current \$) \$ 1,500,000

Notes on Cost Estimation:

Based on the pipe cost per linear foot assumptions found on the "Assumptions" tab.

[Go to Assumptions Tab](#)

**City of Renton
Long-Range Wastewater Master Plan
Capital Improvement Program**



Project ID:	P-01	Project Cost (Current \$):	\$ 1,500,000
Project Name:	2020 Sanitary Sewer Main Replacement/Rehabilitation	Project Cost (Future \$):	\$ 1,500,000
Facility Type:	Pipe	Project Timing:	2020 to 2020
Developer Share:	0	Inflation Rate:	3%

[Go to CIP Summary](#)

Cost Allocation:

Project Type	Percent	Cost
Cross Category	0%	\$ -
Maintenance	100%	\$ 1,500,000
General	0%	\$ -
Total Project Cost	100%	\$ 1,500,000

Project Timing:

Project Element	Timing	Project Cost (Current \$)	Project Cost (Future \$)
2020 Sanitary Sewer Main Replacement/Rehabilitation	2020	\$ 1,500,000	\$ 1,500,000
		\$ -	\$ -
Total Project Cost		\$ 1,500,000	\$ 1,500,000

Project Location:

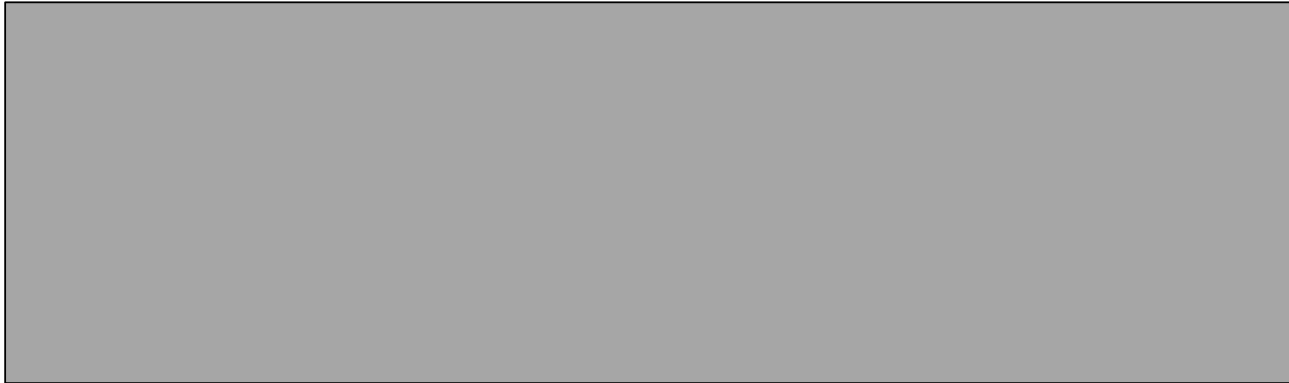

Notes:

See full map on "Maps" tab.

City of Renton
Long-Range Wastewater Master Plan
Capital Improvement Program



Project ID:	P-02	Project Cost (Current \$):	\$ 2,000,000
Project Name:	2021 Sanitary Sewer Main Replacement/Rehabilitation	Project Cost (Future \$):	\$ 2,060,000
Facility Type:	Pipe	Project Timing:	2021 to 2021
Developer Share:		Inflation Rate:	3%

[Go to CIP Summary](#)

Project Description:

This is an annual program that is performed to identify and either repair, rehabilitate, or replace portions of sewer pipe that do not meet current standards. The program will be city-wide and may consist of individual projects.

Project Cost Estimate (Current \$):

Project Element	Quantity	Unit	Unit Cost (\$/Unit)	Subtotal	City Admin	Design	Construction	Scope Contingency	Total Cost (Current \$)
					10%	20%	10%	30%	
2021 Sanitary Sewer Main Replacement/Rehabilitation	1	LF	\$ 2,000,000	\$ 2,000,000					\$ 2,000,000

Total Project Cost (Current \$)	\$ 2,000,000
--	---------------------

Notes on Cost Estimation:

Based on the pipe cost per linear foot assumptions found on the "Assumptions" tab.

[Go to Assumptions Tab](#)

City of Renton
Long-Range Wastewater Master Plan
Capital Improvement Program



Project ID:	P-02	Project Cost (Current \$):	\$ 2,000,000
Project Name:	2021 Sanitary Sewer Main Replacement/Rehabilitation	Project Cost (Future \$):	\$ 2,060,000
Facility Type:	Pipe	Project Timing:	2021 to 2021
Developer Share:	0	Inflation Rate:	3%

[Go to CIP Summary](#)

Cost Allocation:

Project Type	Percent	Cost
Cross Category	0%	\$ -
Maintenance	100%	\$ 2,000,000
General	0%	\$ -
Total Project Cost	100%	\$ 2,000,000

Project Timing:

Project Element	Timing	Project Cost (Current \$)	Project Cost (Future \$)
2021 Sanitary Sewer Main Replacement/Rehabilitation	2021	\$ 2,000,000	\$ 2,060,000
		\$ -	\$ -
Total Project Cost		\$ 2,000,000	\$ 2,060,000

Project Location:



Notes:

See full map on "Maps" tab.

City of Renton
Long-Range Wastewater Master Plan
Capital Improvement Program



Project ID:	P-03	Project Cost (Current \$):	\$ 2,000,000
Project Name:	2022 Sanitary Sewer Main Replacement/Rehabilitation	Project Cost (Future \$):	\$ 2,121,800
Facility Type:	Pipe	Project Timing:	2022 to 2022
Developer Share:		Inflation Rate:	3%

[Go to CIP Summary](#)

Project Description:

This is an annual program that is performed to identify and either repair, rehabilitate, or replace portions of sewer pipe that do not meet current standards. The program will be city-wide and may consist of individual projects.

Project Cost Estimate (Current \$):

Project Element	Quantity	Unit	Unit Cost (\$/Unit)	Subtotal	City Admin	Design	Construction	Scope Contingency	Total Cost (Current \$)
					10%	20%	10%	30%	
2022 Sanitary Sewer Main Replacement/Rehabilitation	1	LF	\$ 2,000,000	\$ 2,000,000					\$ 2,000,000

Total Project Cost (Current \$)	\$ 2,000,000
--	---------------------

Notes on Cost Estimation:

Based on the pipe cost per linear foot assumptions found on the "Assumptions" tab.

[Go to Assumptions Tab](#)

City of Renton
Long-Range Wastewater Master Plan
Capital Improvement Program



Project ID:	P-03	Project Cost (Current \$):	\$ 2,000,000
Project Name:	2022 Sanitary Sewer Main Replacement/Rehabilitation	Project Cost (Future \$):	\$ 2,121,800
Facility Type:	Pipe	Project Timing:	2022 to 2022
Developer Share:	0	Inflation Rate:	3%

[Go to CIP Summary](#)

Cost Allocation:

Project Type	Percent	Cost
Cross Category	0%	\$ -
Maintenance	100%	\$ 2,000,000
General	0%	\$ -
Total Project Cost	100%	\$ 2,000,000

Project Timing:

Project Element	Timing	Project Cost (Current \$)	Project Cost (Future \$)
2022 Sanitary Sewer Main Replacement/Rehabilitation	2022	\$ 2,000,000	\$ 2,121,800
		\$ -	\$ -
Total Project Cost		\$ 2,000,000	\$ 2,121,800

Project Location:



Notes:

See full map on "Maps" tab.

City of Renton
Long-Range Wastewater Master Plan
Capital Improvement Program



Project ID:	P-04	Project Cost (Current \$):	\$ 2,000,000
Project Name:	2023 Sanitary Sewer Main Replacement/Rehabilitation	Project Cost (Future \$):	\$ 2,185,454
Facility Type:	Pipe	Project Timing:	2023 to 2023
Developer Share:		Inflation Rate:	3%

[Go to CIP Summary](#)

Project Description:

This is an annual program that is performed to identify and either repair, rehabilitate, or replace portions of sewer pipe that do not meet current standards. The program will be city-wide and may consist of individual projects.

Project Cost Estimate (Current \$):

Project Element	Quantity	Unit	Unit Cost (\$/Unit)	Subtotal	City Admin	Design	Construction	Scope Contingency	Total Cost (Current \$)
					10%	20%	10%	30%	
2023 Sanitary Sewer Main Replacement/Rehabilitation	1	LF	\$ 2,000,000	\$ 2,000,000					\$ 2,000,000

Total Project Cost (Current \$)	\$ 2,000,000
--	--------------

Notes on Cost Estimation:

Based on the pipe cost per linear foot assumptions found on the "Assumptions" tab.

[Go to Assumptions Tab](#)

**City of Renton
Long-Range Wastewater Master Plan
Capital Improvement Program**



Project ID:	P-04	Project Cost (Current \$):	\$ 2,000,000
Project Name:	2023 Sanitary Sewer Main Replacement/Rehabilitation	Project Cost (Future \$):	\$ 2,185,454
Facility Type:	Pipe	Project Timing:	2023 to 2023
Developer Share:	0	Inflation Rate:	3%

[Go to CIP Summary](#)

Cost Allocation:

Project Type	Percent	Cost
Cross Category	0%	\$ -
Maintenance	100%	\$ 2,000,000
General	0%	\$ -
Total Project Cost	100%	\$ 2,000,000

Project Timing:

Project Element	Timing	Project Cost (Current \$)	Project Cost (Future \$)
2023 Sanitary Sewer Main Replacement/Rehabilitation	2023	\$ 2,000,000	\$ 2,185,454
		\$ -	\$ -
Total Project Cost		\$ 2,000,000	\$ 2,185,454

Project Location:



Notes:

See full map on "Maps" tab.

City of Renton
Long-Range Wastewater Master Plan
Capital Improvement Program



Project ID:	P-05	Project Cost (Current \$):	\$ 2,000,000
Project Name:	2024 Sanitary Sewer Main Replacement/Rehabilitation	Project Cost (Future \$):	\$ 2,251,018
Facility Type:	Pipe	Project Timing:	2024 to 2024
Developer Share:		Inflation Rate:	3%

[Go to CIP Summary](#)

Project Description:

This is an annual program that is performed to identify and either repair, rehabilitate, or replace portions of sewer pipe that do not meet current standards. The program will be city-wide and may consist of individual projects.

Project Cost Estimate (Current \$):

Project Element	Quantity	Unit	Unit Cost (\$/Unit)	Subtotal	City Admin	Design	Construction	Scope Contingency	Total Cost (Current \$)
					10%	20%	10%	30%	
2024 Sanitary Sewer Main Replacement/Rehabilitation	1	LF	\$ 2,000,000	\$ 2,000,000					\$ 2,000,000

Total Project Cost (Current \$)	\$ 2,000,000
--	---------------------

Notes on Cost Estimation:

Based on the pipe cost per linear foot assumptions found on the "Assumptions" tab.

[Go to Assumptions Tab](#)

City of Renton
Long-Range Wastewater Master Plan
Capital Improvement Program



Project ID:	P-05	Project Cost (Current \$):	\$ 2,000,000
Project Name:	2024 Sanitary Sewer Main Replacement/Rehabilitation	Project Cost (Future \$):	\$ 2,251,018
Facility Type:	Pipe	Project Timing:	2024 to 2024
Developer Share:	0	Inflation Rate:	3%

[Go to CIP Summary](#)

Cost Allocation:

Project Type	Percent	Cost
Cross Category	0%	\$ -
Maintenance	100%	\$ 2,000,000
General	0%	\$ -
Total Project Cost	100%	\$ 2,000,000

Project Timing:

Project Element	Timing	Project Cost (Current \$)	Project Cost (Future \$)
2024 Sanitary Sewer Main Replacement/Rehabilitation	2024	\$ 2,000,000	\$ 2,251,018
		\$ -	\$ -
Total Project Cost		\$ 2,000,000	\$ 2,251,018

Project Location:

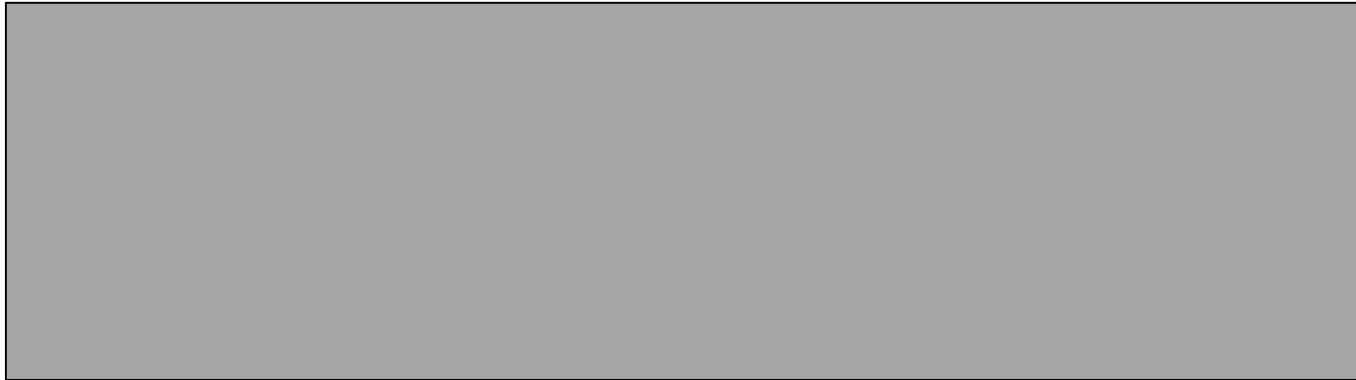

Notes:

See full map on "Maps" tab.

City of Renton
Long-Range Wastewater Master Plan
Capital Improvement Program



Project ID:	P-06	Project Cost (Current \$):	\$ 3,535,712
Project Name:	2025 Sanitary Sewer Main Replacement/Rehabilitation	Project Cost (Future \$):	\$ 4,098,859
Facility Type:	Pipe	Project Timing:	2025 to 2025
Developer Share:		Inflation Rate:	3%

[Go to CIP Summary](#)

Project Description:

This is an annual program that is performed to identify and either repair, rehabilitate, or replace portions of sewer pipe that do not meet current standards. The program will be city-wide and may consist of individual projects.

Project Cost Estimate (Current \$):

Project Element	Quantity	Unit	Unit Cost (\$/Unit)	Subtotal	City Admin	Design	Construction	Scope Contingency	Total Cost (Current \$)
					10%	20%	10%	30%	
2025 Sanitary Sewer Main Replacement/Rehabilitation	1	LF	\$ 2,000,000	\$ 2,000,000					\$ 3,535,712

Total Project Cost (Current \$) \$ 3,535,712

Notes on Cost Estimation:

These unit costs were calculated annually in the 'Rehabilitation Program' spreadsheet.

[Go to Assumptions Tab](#)

**City of Renton
Long-Range Wastewater Master Plan
Capital Improvement Program**



Project ID:	P-06	Project Cost (Current \$):	\$ 3,535,712
Project Name:	2025 Sanitary Sewer Main Replacement/Rehabilitation	Project Cost (Future \$):	\$ 4,098,859
Facility Type:	Pipe	Project Timing:	2025 to 2025
Developer Share:	0	Inflation Rate:	3%

[Go to CIP Summary](#)

Cost Allocation:

Project Type	Percent	Cost
Cross Category	0%	\$ -
Maintenance	100%	\$ 3,535,712
General	0%	\$ -
Total Project Cost	100%	\$ 3,535,712

Project Timing:

Project Element	Timing	Project Cost (Current \$)	Project Cost (Future \$)
2025 Sanitary Sewer Main Replacement/Rehabilitation	2025	\$ 3,535,712	\$ 4,098,859
		\$ -	\$ -
Total Project Cost		\$ 3,535,712	\$ 4,098,859

Project Location:

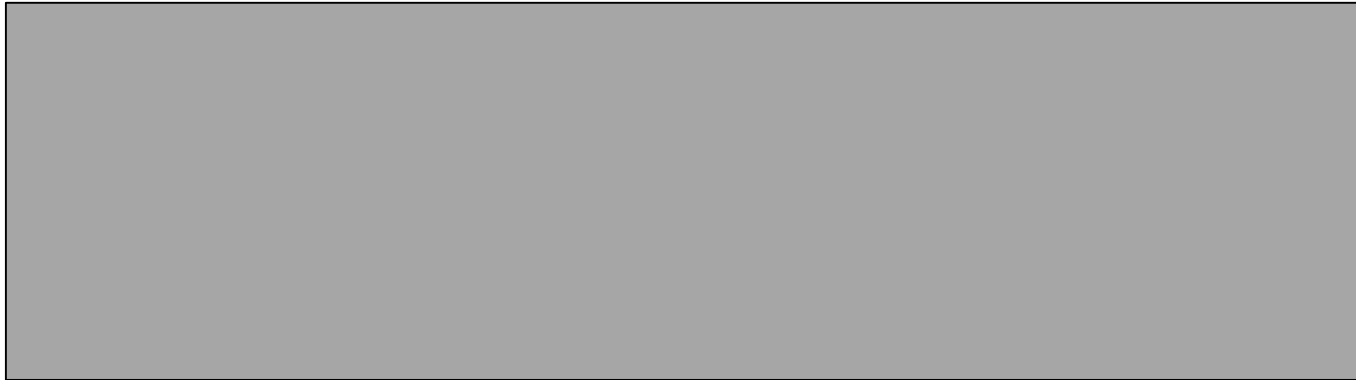

Notes:

See full map on "Maps" tab.

City of Renton
Long-Range Wastewater Master Plan
Capital Improvement Program



Project ID:	P-07	Project Cost (Current \$):	\$ 14,142,847
Project Name:	2026-2029 Sanitary Sewer Main Replacement/Rehabilitation	Project Cost (Future \$):	\$ 17,662,540
Facility Type:	Pipe	Project Timing:	2026 to 2029
Developer Share:		Inflation Rate:	3%

[Go to CIP Summary](#)

Project Description:

This is an annual program that is performed to identify and either repair, rehabilitate, or replace portions of sewer pipe that do not meet current standards. The program will be city-wide and may consist of individual projects.

Project Cost Estimate (Current \$):

Project Element	Quantity	Unit	Unit Cost (\$/Unit)	Subtotal	City Admin	Design	Construction	Scope Contingency	Total Cost (Current \$)
					10%	20%	10%	30%	
2026-2029 Sanitary Sewer Main Replacement/Rehabilitation	4		\$ 3,535,712	\$ 14,142,847.16					\$ 14,142,847

Total Project Cost (Current \$)	\$ 14,142,847
--	----------------------

Notes on Cost Estimation:

These unit costs were calculated annually in the 'Rehabilitation Program' spreadsheet.

[Go to Assumptions Tab](#)

**City of Renton
Long-Range Wastewater Master Plan
Capital Improvement Program**



Project ID: P-07
Project Name: 2026-2029 Sanitary Sewer Main Replacement/Rehabilitation
Facility Type: Pipe
Developer Share: 0

Project Cost (Current \$): \$ 14,142,847
Project Cost (Future \$): \$ 17,662,540
Project Timing: 2026 to 2029
Inflation Rate: 3%

[Go to CIP Summary](#)

Cost Allocation:

Project Type	Percent	Cost
Cross Category	0%	\$ -
Maintenance	100%	\$ 14,142,847
General	0%	\$ -

Total Project Cost	100% \$ 14,142,847
---------------------------	--------------------

Project Timing:

Project Element	Timing	Project Cost (Current \$)	Project Cost (Future \$)
2026-2029 Sanitary Sewer Main Replacement/Rehabilitation	2026	\$ 3,535,712	\$ 4,221,825
2026-2029 Sanitary Sewer Main Replacement/Rehabilitation	2027	\$ 3,535,712	\$ 4,348,480
2026-2029 Sanitary Sewer Main Replacement/Rehabilitation	2028	\$ 3,535,712	\$ 4,478,934
2026-2029 Sanitary Sewer Main Replacement/Rehabilitation	2029	\$ 3,535,712	\$ 4,613,302

Total Project Cost	\$ 14,142,847 \$ 17,662,540
---------------------------	-----------------------------

Project Location:

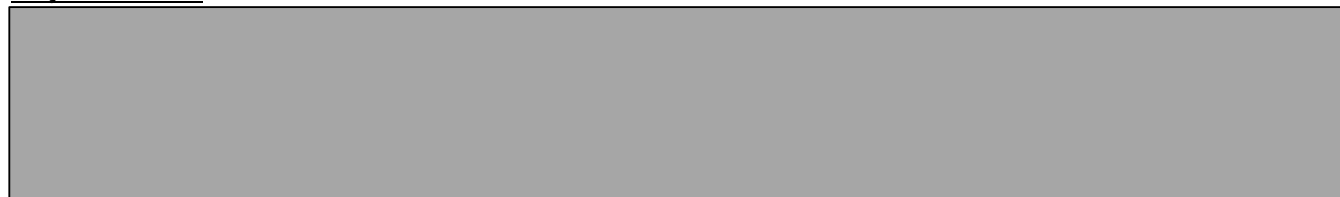

Notes:

See full map on "Maps" tab.

**City of Renton
Long-Range Wastewater Master Plan
Capital Improvement Program**



Project ID:	P-08	Project Cost (Current \$):	\$ 35,357,118
Project Name:	2030-2039 Sanitary Sewer Main Replacement/Rehabilitation	Project Cost (Future \$):	\$ 55,085,238
Facility Type:	Pipe	Project Timing:	Long-term
Developer Share:		Inflation Rate:	3%

[Go to CIP Summary](#)

Project Description:

This is an annual program that is performed to identify and either repair, rehabilitate, or replace portions of sewer pipe that do not meet current standards. The program will be city-wide and may consist of individual projects.

Project Cost Estimate (Current \$):

Project Element	Quantity	Unit	Unit Cost (\$/Unit)	Subtotal	City Admin	Design	Construction	Scope Contingency	Total Cost (Current \$)
					10%	20%	10%	30%	
2030-2039 Sanitary Sewer Main Replacement/Rehabilitation	10		\$ 3,535,712	\$ 35,357,117.89					\$ 35,357,118

Total Project Cost (Current \$)	\$ 35,357,118
--	---------------

Notes on Cost Estimation:

These unit costs were calculated annually in the 'Rehabilitation Program' spreadsheet.

[Go to Assumptions Tab](#)

**City of Renton
Long-Range Wastewater Master Plan
Capital Improvement Program**



Project ID:	P-08	Project Cost (Current \$):	\$ 35,357,118
Project Name:	2030-2039 Sanitary Sewer Main Replacement/Rehabilitation	Project Cost (Future \$):	\$ 55,085,238
Facility Type:	Pipe	Project Timing:	Long-term
Developer Share:	0	Inflation Rate:	3%

[Go to CIP Summary](#)

Cost Allocation:

Project Type	Percent	Cost
Cross Category	0%	\$ -
Maintenance	100%	\$ 35,357,118
General	0%	\$ -

Total Project Cost	100%	\$ 35,357,118
---------------------------	------	---------------

Project Timing:

Project Element	Timing	Project Cost (Current \$)	Project Cost (Future \$)
2030-2039 Sanitary Sewer Main Replacement/Rehabilitation	Long-term	\$ 35,357,118	\$ 55,085,238

Total Project Cost		\$ 35,357,118	\$ 55,085,238
---------------------------	--	---------------	---------------

Project Location:

Notes:

**City of Renton
Long-Range Wastewater Master Plan
Capital Improvement Program**



Project ID: P-09 **Project Cost (Current \$):** \$ 5,808,763
Project Name: Sewer Capacity Improvements **Project Cost (Future \$):** \$ 6,257,687
Facility Type: Pipe **Project Timing:** 2021 to 2024
Developer Share: **Inflation Rate:** 3%

[Go to CIP Summary](#)

Project Description:

Pipe upsizing is determined after the pipe was monitored, the most cost effective solution for these pipes are to increase their size. Since a larger pipe would need to be installed, the construction is estimated with open-cut installation. Additionally, the pipe reconfiguration includes locations where the pipe has a reverse slope causing a deficiency in the system. After confirmation that the slope information is accurate, pipe replacement is the recommended action. For pipe replacement, it would involve open cut construction. Locations include the following sections: Edmonds Ave and NE 9th St, Monroe Ave and NE 7th St, Grant Ave and SE 9th St, SE 99th Ct, and Jericho Pl and NE 16th St.

Project Cost Estimate (Current \$):

Project Element	Quantity	Unit	Unit Cost (\$/Unit)	Subtotal	City Admin	Design	Construction	Scope Contingency	Total Cost (Current \$)
					10%	20%	10%	30%	
23A - 8" to 12" Diameter Pipe	386	LF	\$ 363	\$ 140,118	\$ 14,012	\$ 28,024	\$ 14,012	\$ 58,850	\$ 255,015
23A - 12" to 16" Diameter Pipe	42	LF	\$ 385	\$ 16,170	\$ 1,617	\$ 3,234	\$ 1,617	\$ 6,791	\$ 29,429
BA - 8" to 12" Diameter Pipe	1,718	LF	\$ 363	\$ 623,634	\$ 62,363	\$ 124,727	\$ 62,363	\$ 261,926	\$ 1,135,014
46A - 8" to 12" Diameter Pipe	3,278	LF	\$ 363	\$ 1,189,914	\$ 118,991	\$ 237,983	\$ 118,991	\$ 499,764	\$ 2,165,643
46A - 12" to 16" Diameter Pipe	73	LF	\$ 385	\$ 28,105	\$ 2,811	\$ 5,621	\$ 2,811	\$ 11,804	\$ 51,151
37A: 8" Edmonds Ave and NE 9th St Reconfiguration	843	LF	\$ 341	\$ 287,463	\$ 28,746	\$ 57,493	\$ 28,746	\$ 120,734	\$ 523,183
37A: 16" Edmonds Ave and NE 9th St Reconfiguration	50	LF	\$ 385	\$ 19,250	\$ 1,925	\$ 3,850	\$ 1,925	\$ 8,085	\$ 35,035
24A: 8" Monroe Ave and NE 7th St Reconfiguration	240	LF	\$ 341	\$ 81,840	\$ 8,184	\$ 16,368	\$ 8,184	\$ 34,373	\$ 148,949
24A: 12" Monroe Ave and NE 7th St Reconfiguration	100	LF	\$ 363	\$ 36,300	\$ 3,630	\$ 7,260	\$ 3,630	\$ 15,246	\$ 66,066
11A: 10" Grant Ave and Se 9th St Reconfiguration	1,477	LF	\$ 352	\$ 519,904	\$ 51,990	\$ 103,981	\$ 51,990	\$ 218,360	\$ 946,225
20A: 8" SE 99th Ct Reconfiguration	447	LF	\$ 341	\$ 152,427	\$ 15,243	\$ 30,485	\$ 15,243	\$ 64,019	\$ 277,417
20B: 8" Jericho Pl and NE 16th St Reconfiguration	283	LF	\$ 341	\$ 96,503	\$ 9,650	\$ 19,301	\$ 9,650	\$ 40,531	\$ 175,635

Total Project Cost (Current \$) \$ 5,808,763

Notes on Cost Estimation:

Based on the pipe cost per linear foot assumptions found on the "Assumptions" tab.

[Go to Assumptions Tab](#)

City of Renton
 Long-Range Wastewater Master Plan
 Capital Improvement Program



Project ID: P-09
Project Name: Sewer Capacity Improvements
Facility Type: Pipe
Developer Share: 0

Project Cost (Current \$): \$ 5,808,763
Project Cost (Future \$): \$ 6,257,687
Project Timing: 2021 to 2024
Inflation Rate: 3%

[Go to CIP Summary](#)

Cost Allocation:

Project Type	Percent	Cost
Cross Category	100%	\$ 5,808,763
Maintenance	0%	\$ -
Planning	0%	\$ -

Project Timing:

Project Element	Timing	Project Cost (Current \$)	Project Cost (Future \$)
Sewer Capacity Improvements	2021	\$ 1,452,191	\$ 1,495,756
Sewer Capacity Improvements	2022	\$ 1,452,191	\$ 1,540,629
Sewer Capacity Improvements	2023	\$ 1,452,191	\$ 1,586,848
Sewer Capacity Improvements	2024	\$ 1,452,191	\$ 1,634,453

Total Project Cost 100% \$ 5,808,763

Total Project Cost \$ 5,808,763 \$ 6,257,687

Project Location:

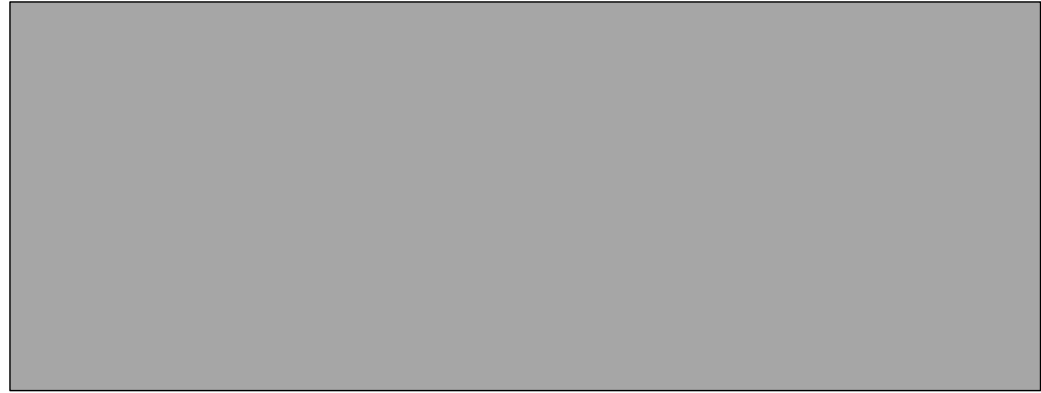

Notes:

See full map on

**City of Renton
Long-Range Wastewater Master Plan
Capital Improvement Program**



Project ID:	P-10	Project Cost (Current \$):	\$1,470,300
Project Name:	Flow Monitoring Program	Project Cost (Future \$):	\$1,629,717
Facility Type:	Pipe	Project Timing:	2022 to 2026
Developer Share:		Inflation Rate:	3%

[Go to CIP Summary](#)

Project Description:

The additional long-term depth monitoring project is to verify the existence of a deficiency in the specified pipe. These locations have typically not been observed deficient, so additional monitoring over a specified period of time to observe deficiency is recommended. The Talbot Rd S and 36th St to 27th Place location is recommended for monitoring for at most 5 years to determine potential deficiency. The Whitman Ct NE and NE 12th location is recommended for monitoring for a maximum of 2 years to determine potential deficiency. The Anacortes Ave NE and NE 17th St to NE 26th St location is recommended for monitoring for a maximum of 1 year to determine potential deficiency. The Renton High School location is recommended for monitoring for a maximum of 1 year to determine potential deficiency. Altogether, the flow and monitoring program timing will be short, medium, and long-term.

Project Cost Estimate (Current \$):

Project Element	Quantity		Units	Unit Cost	Subtotal	City Admin	Design	Construction	Scope Contingency	Total Cost (Current \$)
	Meter									
	No.	Dur.								
05A - Talbot Rd S and 36th St to 27th Place	1	60	Meter/Mo	\$ 20,000	\$ 95,000	\$ 9,500	\$ 19,000	\$ 9,500	\$ 39,900	\$ 172,900
14A - West Sunset Blvd and SW 4th Place	1	84	Meter/Mo	\$ 20,000	\$ 125,000	\$ 12,500	\$ 25,000	\$ 12,500	\$ 52,500	\$ 227,500
15A - Renton High School	1	84	Meter/Mo	\$ 20,000	\$ 125,000	\$ 9,500	\$ 25,000	\$ 12,500	\$ 51,600	\$ 223,600
21A - Anacortes Ave NE and NE 17th to NE 26th St	2	84	Meter/Mo	\$ 20,000	\$ 145,000	\$ 14,500	\$ 29,000	\$ 14,500	\$ 60,900	\$ 263,900
22A - Whitman Ct NE and NE 12th St	2	24	Meter/Mo	\$ 20,000	\$ 70,000	\$ 7,000	\$ 14,000	\$ 7,000	\$ 29,400	\$ 127,400
41A: Lake Washington Blvd and 32nd to 36th St	1	84	Meter/Mo	\$ 20,000	\$ 125,000	\$ 12,500	\$ 25,000	\$ 12,500	\$ 52,500	\$ 227,500
48A - NE 7th St and Harington Ave NE	1	84	Meter/Mo	\$ 20,000	\$ 125,000	\$ 12,500	\$ 25,000	\$ 12,500	\$ 52,500	\$ 227,500

Total Project Cost (Current \$)	\$ 1,470,300
--	--------------

Notes on Cost Estimation:

Based on the pipe cost per linear foot assumptions found on the "Assumptions" tab. 20k for initial meter installation.
15k/yr/meter for service/analysis

[Go to Assumptions Tab](#)

**City of Renton
Long-Range Wastewater Master Plan
Capital Improvement Program**



Project ID: P-10 **Project Cost (Current \$):** \$ 1,470,300

Project Name: Flow Monitoring Program **Project Cost (Future \$):** \$ 1,629,717

Facility Type: Pipe **Project Timing:** 2022 to 2026

Developer Share: 0 **Inflation Rate:** 3%

[Go to CIP Summary](#)

Cost Allocation:

Project Type	Percent	Cost
Cross Category	100%	\$ 1,470,300
Maintenance	0%	\$ -
Planning	0%	\$ -

Total Project Cost 100% \$ 1,470,300

Project Timing:

Project Element	Timing	Project Cost (Current \$)	Project Cost (Future \$)
Flow Monitoring Program	2022	\$ 332,280	\$ 332,280
Flow Monitoring Program	2023	\$ 332,280	\$ 363,091
Flow Monitoring Program	2024	\$ 268,580	\$ 302,289
Flow Monitoring Program	2025	\$ 268,580	\$ 311,358
Flow Monitoring Program	2026	\$ 268,580	\$ 320,699

Total Project Cost \$ 1,470,300 \$ 1,629,717

Project Location:

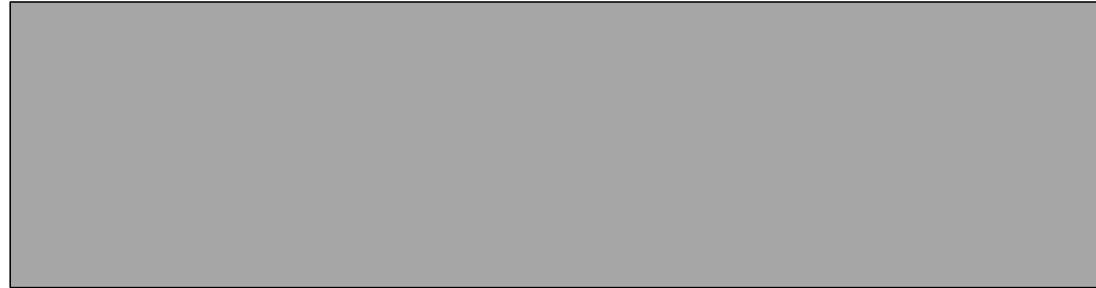

Notes:

See full map

City of Renton
Long-Range Wastewater Master Plan
Capital Improvement Program



Project ID: P-11
Project Name: I/I Evaluation Program
Facility Type: Pipe
Developer Share:

Project Cost (Current \$): \$ 1,674,400
Project Cost (Future \$): \$ 2,088,480
Project Timing: 2022 to Long-term
Inflation Rate: 3%

[Go to CIP Summary](#)

Project Description:

Micro-monitoring project is recommended for areas in wastewater basins where there were signs of significant I/I in the collection system. Micro-monitoring involved installing multiple flow monitors where there is high I/I, and break larger basins into smaller basis to better refine the location of high I/I. By micro-monitoring, an isolated location within the basin would be identified and only this section would need to be replaced. Locations include S Renton Village Pl from Valley Fwy to Talbot Rd S, Lake Ave S to 15th St, Benson Rd S to S Eagle Dr., and Jones Dr SE to SE 18th Pl as one project element of I/I Micro-Monitoring. Additionally Lake Washington Blvd and 32nd to 36th St are recommended for monitoring.

Project Cost Estimate (Current \$):

Project Element	Quantity		Unit	Unit Cost (\$/Unit)	Subtotal	City Admin	Design	Construction	Scope Contingency	Total Cost (Current \$)
	Meter					10%	20%	10%	30%	
	No.	Dur.								
Basin Monitoring (8 Basins)	24	5	Meters/Mo	\$ 120,000	\$ 600,000	\$ 60,000	\$ 120,000	\$ 60,000	\$ 252,000	\$ 1,092,000
Basin Study	8		Meters/Mo	\$ 40,000	\$ 320,000	\$ 32,000	\$ 64,000	\$ 32,000	\$ 134,400	\$ 582,400

Total Project Cost (Current \$) \$ 1,674,400

Notes on Cost Estimation:

Based on the pipe cost per linear foot assumptions found on the "Assumptions" tab.
 5k/meter/month for evaluation and 40k per basin for the study

[Go to Assumptions Tab](#)

**City of Renton
Long-Range Wastewater Master Plan
Capital Improvement Program**



Project ID: P-11
Project Name: I/I Evaluation Program
Facility Type: Pipe
Developer Share: 0

Project Cost (Current \$): \$ 1,674,400
Project Cost (Future \$): \$ 2,088,480
Project Timing: 2022 to Long-term
Inflation Rate: 3%

[Go to CIP Summary](#)

Cost Allocation:

Project Type	Percent	Cost
Cross Category	100%	\$ 1,674,400
Maintenance	0%	\$ -
Planning	0%	\$ -
Total Project Cost	100%	\$ 1,674,400

Project Timing:

Project Element	Timing	Project Cost (Current \$)	Project Cost (Future \$)
Short Term I/I Eval	2022	\$ 682,500	\$ 724,064
Long Term I/I Eval	Long-term	\$ 409,500	\$ 637,988
Short Term Study	2022	\$ 364,000	\$ 386,168
Long Term Study	Long-term	\$ 218,400	\$ 340,260
Total Project Cost		\$ 1,674,400	\$ 2,088,480

Project Location:

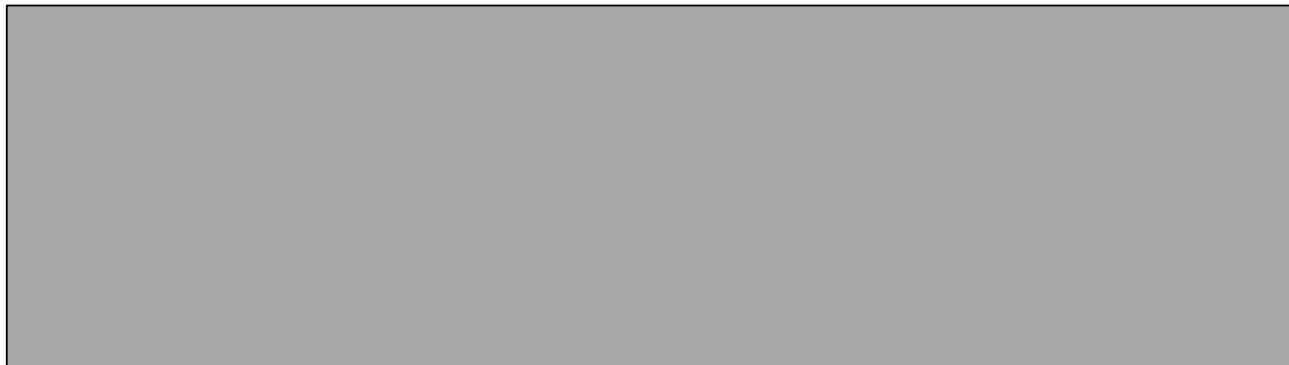

Notes:

See full map on "Maps" tab.

City of Renton
Long-Range Wastewater Master Plan
Capital Improvement Program



Project ID:	G-01	Project Cost (Current \$):	\$ 300,000
Project Name:	Wastewater Operations Master Plan	Project Cost (Future \$):	\$ 300,000
Facility Type:	General	Project Timing:	2020 to 2020
Developer Share:		Inflation Rate:	3%

[Go to CIP Summary](#)

Project Description:

The Wastewater Operations Master Plan (OMP) is a plan created by the City. The first purpose of this plan is to document current procedures and programs into an O&M manual, review existing programs for effectiveness and compliance of potential future regulatory requirements. The second purpose is to analyze and recommend program improvements in accordance with the City's long-term goals and objectives, and assist with the development of an improvement implementation strategy. Based on the City's existing resources and implementation budget, it is recommended to implement this plan over 5 years, with the highest priority improvements being completed first.

Project Cost Estimate (Current \$):

Project Element	Quantity	Unit	Unit Cost (\$/Unit)	Subtotal	City Admin	Design	Construction	Scope Contingency	Total Cost (Current \$)
					10%	20%	10%	30%	
Wastewater Operations Master Plan	1	LS	\$ 600,000	\$ 600,000					\$ 600,000

Total Project Cost (Current \$) \$ 600,000

Notes on Cost Estimation:

Based on the pipe cost per linear foot assumptions found on the "Assumptions" tab. Half of Master Plan total cost is distributed to 2019 which is prior to the CIP planning period.

[Go to Assumptions Tab](#)

**City of Renton
Long-Range Wastewater Master Plan
Capital Improvement Program**



Project ID:	G-01	Project Cost (Current \$):	\$ 300,000
Project Name:	Wastewater Operations Master Plan	Project Cost (Future \$):	\$ 300,000
Facility Type:	General	Project Timing:	2020 to 2020
Developer Share:	0	Inflation Rate:	3%

[Go to CIP Summary](#)

Cost Allocation:

Project Type	Percent	Cost
Cross Category	0%	\$ -
Maintenance	0%	\$ -
Planning	100%	\$ 600,000
Total Project Cost	100%	\$ 600,000

Project Timing:

Project Element	Timing	Project Cost (Current \$)	Project Cost (Future \$)
Wastewater Operations Master Plan	2020	\$ 300,000	\$ 300,000
		\$ -	\$ -
		\$ -	\$ -
Total Project Cost		\$ 300,000	\$ 300,000

Project Location:

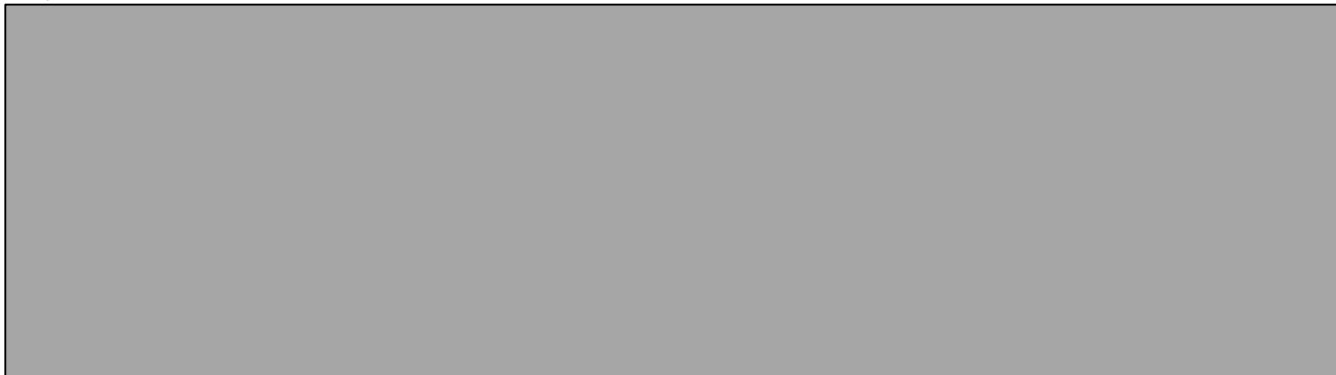

Notes:

See full map on "Maps" tab.

City of Renton
Long-Range Wastewater Master Plan
Capital Improvement Program



Project ID:	G-02	Project Cost (Current \$):	\$ 300,000
Project Name:	Long-Range Wastewater Management Plan	Project Cost (Future \$):	\$ 337,653
Facility Type:	General	Project Timing:	2024 to 2024
Developer Share:		Inflation Rate:	3%

[Go to CIP Summary](#)

Project Description:

The Long Range Wastewater Management Plan considers a 20-year planning period for the analysis of existing and projected conditions. The sewage collection system's operational and capital requirements are detailed to achieve the City's operational goals and fulfill regulatory requirements.

Project Cost Estimate (Current \$):

Project Element	Quantity	Unit	Unit Cost (\$/Unit)	Subtotal	City Admin	Design	Construction	Scope Contingency	Total Cost (Current \$)
					10%	20%	10%	30%	
Long Range Wastewater Management Plan	1	LS	\$ 300,000	\$ 300,000					\$ 300,000

Total Project Cost (Current \$)	\$ 300,000
--	------------

Notes on Cost Estimation:

Based on the pipe cost per linear foot assumptions found on the "Assumptions" tab.

[Go to Assumptions Tab](#)

**City of Renton
Long-Range Wastewater Master Plan
Capital Improvement Program**



Project ID:	G-02	Project Cost (Current \$):	\$	300,000
Project Name:	Long-Range Wastewater Management Plan	Project Cost (Future \$):	\$	337,653
Facility Type:	General	Project Timing:	2024 to 2024	
Developer Share:	0	Inflation Rate:	3%	

[Go to CIP Summary](#)

Cost Allocation:

Project Type	Percent	Cost
Cross Category	0%	\$ -
Maintenance	0%	\$ -
Planning	100%	\$ 300,000
Total Project Cost	100%	\$ 300,000

Project Timing:

Project Element	Timing	Project Cost (Current \$)	Project Cost (Future \$)
Long Range Wastewater Management Plan	2024	\$ 300,000	\$ 337,653
		\$ -	\$ -
		\$ -	\$ -
Total Project Cost		\$ 300,000	\$ 337,653

Project Location:



Notes:
See full map on "Maps" tab.

City of Renton
Long-Range Wastewater Master Plan
Capital Improvement Program



Project ID:	G-03	Project Cost (Current \$):	\$ 600,000
Project Name:	Sanitary Sewer Hydraulic Model	Project Cost (Future \$):	\$ 627,270
Facility Type:	General	Project Timing:	2021 to 2022
Developer Share:		Inflation Rate:	3%

[Go to CIP Summary](#)

Project Description:

As discussed in Chapter 7 in the System Infrastructure Capacity, the City has a hydraulic model that allows them to evaluate existing the sanitary sewer system and determine areas of capacity constraint, and provide a tool for planning future improvements. The model needs to be updated as the system expands, and flow monitoring and physical system data is collected by survey or field inspection.

Project Cost Estimate (Current \$):

Project Element	Quantity	Unit	Unit Cost (\$/Unit)	Subtotal	City Admin	Design	Construction	Scope Contingency	Total Cost (Current \$)
					10%	20%	10%	30%	
Sanitary Sewer Hydraulic Model	1	LS	\$ 600,000	\$ 600,000					\$ 600,000

Total Project Cost (Current \$)	\$ 600,000
--	------------

Notes on Cost Estimation:

Based on the pipe cost per linear foot assumptions found on the "Assumptions" tab.

[Go to Assumptions Tab](#)

City of Renton
Long-Range Wastewater Master Plan
Capital Improvement Program



Project ID:	G-03	Project Cost (Current \$):	\$ 600,000
Project Name:	Sanitary Sewer Hydraulic Model	Project Cost (Future \$):	\$ 627,270
Facility Type:	General	Project Timing:	2021 to 2022
Developer Share:	0	Inflation Rate:	3%

[Go to CIP Summary](#)

Cost Allocation:

Project Type	Percent	Cost
Cross Category	0%	\$ -
Maintenance	0%	\$ -
Planning	100%	\$ 600,000
Total Project Cost	100%	\$ 600,000

Project Timing:

Project Element	Timing	Project Cost (Current \$)	Project Cost (Future \$)
Sanitary Sewer Hydraulic Model	2021	\$ 300,000	\$ 309,000
Sanitary Sewer Hydraulic Model	2022	\$ 300,000	\$ 318,270
		\$ -	\$ -
Total Project Cost		\$ 600,000	\$ 627,270

Project Location:

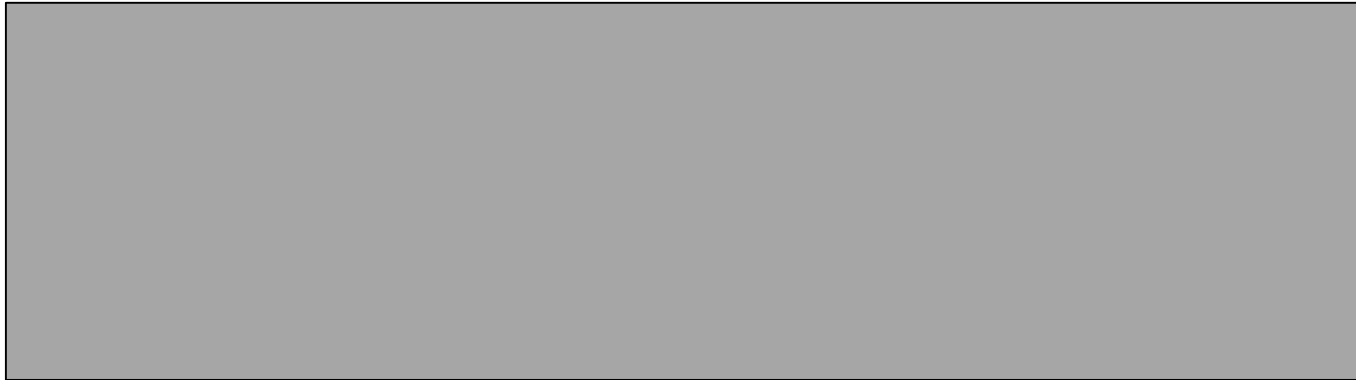

Notes:

See full map on "Maps" tab.

**City of Renton
Long-Range Wastewater Master Plan
Capital Improvement Program**



Project ID: G-04
Project Name: Miscellaneous/Emergency Projects
Facility Type: General
Developer Share:

Project Cost (Current \$): \$ 4,000,000
Project Cost (Future \$): \$ 5,408,711
Project Timing: 2020 to Long-term
Inflation Rate: 3%

[Go to CIP Summary](#)

Project Description:

This project is to perform small repairs, replacements, or installations of sewers that are not scheduled in the CIP, but become a priority due to unexpected problems, failures, or coordination with other projects.

Project Cost Estimate (Current \$):

Project Element	Quantity	Unit	Unit Cost (\$/Unit)	Subtotal	City Admin	Design	Construction	Scope Contingency	Total Cost (Current \$)
					10%	20%	10%	30%	
Miscellaneous/Emergency Projects	20		\$ 200,000	\$ 4,000,000					\$ 4,000,000

Total Project Cost (Current \$) \$ 4,000,000

Notes on Cost Estimation:

Based on the pipe cost per linear foot assumptions found on the "Assumptions" tab.

[Go to Assumptions Tab](#)

**City of Renton
Long-Range Wastewater Master Plan
Capital Improvement Program**



Project ID: G-04
Project Name: Miscellaneous/Emergency Projects
Facility Type: General
Developer Share: 0

Project Cost (Current \$): \$ 4,000,000
Project Cost (Future \$): \$ 5,408,711
Project Timing: 2020 to Long-term
Inflation Rate: 3%

[Go to CIP Summary](#)

Cost Allocation:

Project Type	Percent	Cost
Cross Category	0%	\$ -
Maintenance	0%	\$ -
Planning	100%	\$ 4,000,000

Project Timing:

Project Element	Timing	Project Cost (Current \$)	Project Cost (Future \$)
Miscellaneous/Emergency Projects	2020	\$ 200,000	\$ 200,000
Miscellaneous/Emergency Projects	2021	\$ 200,000	\$ 206,000
Miscellaneous/Emergency Projects	2022	\$ 200,000	\$ 212,180
Miscellaneous/Emergency Projects	2023	\$ 200,000	\$ 218,545
Miscellaneous/Emergency Projects	2024	\$ 200,000	\$ 225,102
Miscellaneous/Emergency Projects	2025	\$ 200,000	\$ 231,855
Miscellaneous/Emergency Projects	2026	\$ 200,000	\$ 238,810
Miscellaneous/Emergency Projects	2027	\$ 200,000	\$ 245,975
Miscellaneous/Emergency Projects	2028	\$ 200,000	\$ 253,354
Miscellaneous/Emergency Projects	2029	\$ 200,000	\$ 260,955
Miscellaneous/Emergency Projects	Long-term	\$ 2,000,000	\$ 3,115,935

Total Project Cost 100% \$ 4,000,000

Total Project Cost \$ 4,000,000 \$ 5,408,711

Project Location:



Notes:

See full map on "Maps" tab.

Appendix L-1
WELLHEAD PROTECTION PLAN UPDATE

PACIFIC groundwater **GROUP**

**CITY OF RENTON
WELLHEAD PROTECTION PLAN UPDATE
CONTAMINANT SOURCE INVENTORY REPORT**

February 7, 2019

**CITY OF RENTON
WELLHEAD PROTECTION PLAN UPDATE
CONTAMINANT SOURCE INVENTORY REPORT**

Prepared for:

**City of Renton
1055 South Grady Way
Renton, Washington 98057**

Prepared by:

**Pacific Groundwater Group
2377 Eastlake Avenue East, Suite 200
Seattle, Washington 98102
206.329.0141
www.pgwg.com**

February 7, 2010

JE1801

Renton_CSI_2018 v3

TABLE OF CONTENTS

1.0	INTRODUCTION	1
2.0	BACKGROUND	1
2.1	AQUIFER PROTECTION AREA BACKGROUND	2
3.0	WELLHEAD PROTECTION AREA DELINEATION UPDATES	3
4.0	CONTAMINANT SOURCE INVENTORY & RISK ASSESSMENT	4
4.1	DATA SOURCES	5
4.2	CURRENT LAND USE AND ZONING	5
4.3	CONTAMINANT SOURCES.....	6
4.3.1	<i>Contaminant Sources with Known Releases</i>	7
4.3.2	<i>Potential Sources</i>	7
4.4	WINDSHIELD SURVEY FINDINGS.....	16
4.5	WHPA NOTIFICATION LETTERS	16
5.0	REFERENCES	17

TABLES

Table 1:	Summary of Land Use Types of Concern
Table 2:	Summary Data for Parcels of Possible Elevated Risk within Renton Wellhead Protection Areas
Table 3:	Summary of Environmental Sites of Potential Concern within Wellhead Protection Capture Zones
Table 4:	Active Hazardous Materials Sites in Renton WHPAs
Table 5:	Distribution of Septic Systems within City of Renton WHPAs
Table 6:	Distribution of Home Heating Oil Tanks within City of Renton WHPAs
Table 7:	Visited Windshield Survey Cleanup Sites

FIGURES

Figure 1:	City of Renton 2018 Wellhead Protection Area Capture Zones
Figure 2:	Zoning and Parcels of Possible Elevated Risk Within Renton WHPAs
Figure 3:	Zoning and Parcels of Possible Elevated Risk Within Downtown WHPA
Figure 4:	Potential Contaminant Sources within City of Renton WHPAs
Figure 5:	Potential Contaminant Sources within City of Renton Downtown WHPA

APPENDICES

Appendix A:	FSID Interaction Type and Groundwater Risk Identification
Appendix B:	WHPA No Further Action Site Table
Appendix C:	Environmental Sites Information
Appendix D:	Notification Letters

LIST OF ACRONYMS

APA	Aquifer Protection Area
BGS	Below Ground Surface
CEC	Contaminant of Emerging Concern
CSI	Contaminant Source Inventory
EPA	Environmental Protection Agency
DOH	Washington State Department of Health
FSID	Facility Site Identification Database
GIS	Geographic Information System
LUST	Leaking Underground Storage Tank
MCL	Maximum Contaminant Level
NFA	No Further Action
Qa	Annual Water Right Quantity
Qi	Instantaneous Water Right Quantity
SSA	Sole Source Aquifer
UST	Underground Storage Tank
WAC	Washington Administrative Code
WSDOT	Washington Department of Transportation
WHPA	Wellhead Protection Area
WHPP	Wellhead Protection Plan

SIGNATURE

This report, and Pacific Groundwater Group's work contributing to this report, were reviewed by the undersigned and approved for release.



J. GLENN MUTTI-DRISCOLL

A handwritten signature in cursive script, reading "J. Glenn Mutti-Driscoll".

Glenn Mutti-Driscoll
Hydrogeologist
Washington State Hydrogeologist No. 2832

1.0 INTRODUCTION

This report summarizes contaminant risks to groundwater supplies for the City of Renton (City). Information presented in this report supports an update of the City's Water System Plan currently being prepared by Carollo Engineers. This report is an update to the City's prior Wellhead Protection Plan (WHPP) and its purpose is to document known or suspected contaminant sites or sources within the City's Wellhead Protection Areas (WHPAs), and to help the City understand the risks posed by these sources. Elements of this report were developed following the Washington State Department of Health (DOH) guidelines for Wellhead Protection Programs (DOH, 2010).

This report documents the results of the Contaminant Source Inventory (CSI) update performed. This includes updates to the City's WHPAs, results from a "windshield survey" performed by the City and PGG, and example letters to be sent to businesses and property owners within the City's WHPAs.

This work was performed, and this report prepared, in accordance with generally accepted hydrogeologic practices at this time and in this area for the exclusive use of the City of Renton for specific application to the study area. No other warranty, express or implied, is made.

2.0 BACKGROUND

The City of Renton is located in King County, Washington, and has four distinct water sources which include: the Downtown wellfield, the Maplewood wellfield, Springbrook Springs, and Well PW-5A (**Figure 1**). Each water source comes from separate aquifers that are summarized below.

The Downtown wellfield draws its water from the deltaic portion of the Cedar Valley Alluvial Aquifer (from herein referred to as the deltaic aquifer), which has been designated as a Sole Source Aquifer (SSA) by the EPA since 1988. A SSA designation indicates that an aquifer supplies at least 50 percent of the water for its service area and there is no reasonable alternative drinking water source that exists should the aquifer become contaminated¹. The deltaic aquifer near the Downtown wellfield is composed of course-grained sands and gravels and has an average aquifer thickness of approximately 70 feet. The average depth to groundwater is roughly 23 feet below ground surface (bgs) at the Downtown wellfield. Fine-grained sediments (silts and clays) or local bedrock were observed beneath the aquifer at the City production wells. Deposits overlying the deltaic aquifer are composed of silt, sand, and gravel; however, no confining layer exists above the aquifer and it is therefore more vulnerable to contamination than other water supply aquifers in the Renton area. Confining layers can retard the downward flow of contaminants, and thus act as protective layer overlying an aquifer.

The Maplewood wellfield draws its water from the Maplewood Production Aquifer, which is a deep sand and gravel aquifer separated from the surficial aquifer by a leaky

¹ With a SSA designation, the EPA reviews projects located in the SSA area that will receive federal funding to ensure that projects do not contaminate the SSA.

aquitard. The production wells at Maplewood are screened at depths between 284 and 344 feet bgs.

Water discharged at Springbrook Springs is sourced from a sand and gravel aquifer underlying a thick sequence of glacial till. Water from the springs is collected in two infiltration galleries, which convey the water into transmission lines. The springs exhibit a delayed response to seasonal precipitation (City of Renton and Carrollo Engineers, 2012), which suggests that the overlying till acts as a protective fine-grained unit above the aquifer.

Well PW-5A is completed in a deep sand and gravel aquifer zone located approximately 280 to 390 feet bgs. Stratified glacial deposits of fine-to-coarse sand and gravel layered with silt and clay exist above this aquifer. Few other wells are completed to this depth in the Well PW-5A area, and therefore the local extent and thickness of the aquifer is poorly characterized. The Well PW-5A aquifer potentially is connected to the Maplewood Production Aquifer (PGG, 1994a), but an in-depth evaluation of this connection has not been performed.

2.1 AQUIFER PROTECTION AREA BACKGROUND

In 1988, the City created an Aquifer Protection Program with the intent of safeguarding the groundwater supply sources within the City. Because the City developed this program prior to DOH's Wellhead Protection Program, the City defined its program around "Aquifer Protection Areas" (APAs) rather than WHPAs. Different APA zones were delineated relative to the amount of contamination risk associated with an aquifer, with Zone 1 having the highest level of associated risk, followed by Zone 1 Modified and then Zone 2. In 1992, the City passed an Aquifer Protection Ordinance to limit the storage and handling of hazardous material in the APAs. As part of the Aquifer Protection Program, a significant amount of public outreach and education occurred to familiarize elected officials and citizens with the APA concept, where they exist, and land use restrictions associated with them.

In 1994 the Renton Groundwater Model was created (PGG, 1994a; 1994b), which delineated the Downtown and Maplewood wellfield capture zones based on the best available hydrogeologic data at the time.

During the last planning period, the City redefined the extent of the APAs to be consistent with the delineated capture zones in the most current water system plan. The current APAs are defined as follows:

- **APA Zone 1:** Downtown wellfield 1-year WHPA
- **APA Zone 1 Modified:** 1-year WHPA for all other sources
- **APA Zone 2:** 5-year and 10-year WHPAs for all water sources

Based on the historical education and outreach efforts previously performed, the City continues to refer to the Aquifer Protection Program in its outreach materials, rather than a Wellhead Protection Program (as termed by the DOH). Because this report is intended to meet DOH criteria for a Wellhead Protection Plan update, the term Wellhead Protec-

tion Area (or WHPA) will be used to describe time of travel capture zones (rather than APA zones).

3.0 WELLHEAD PROTECTION AREA DELINEATION UPDATES

City WHPAs were previously updated in 1998 by PGG (1998) and have not been revised since. In 1998, each of the City’s four water sources had WHPAs delineated for their 1-, 5-, and 10-year time of travel capture zones. As part of the 2018 WHPP update, the City requested that 6-month capture zones be delineated, and that updated Maplewood pumping rates be applied based on treatment limitations at the Maplewood Treatment Plant. The following table lists the pumping rates used for the 2018 capture zone delineation update, while **Figure 1** shows the extent of the updated capture zones.

Source	WHPA	2018
Well RW-1	Downtown	2,200
Well RW-2	Downtown	2,200
Well RW-3	Downtown	2,200
Well PW-8	Downtown	3,500
Well PW-12	Maplewood	1,600
Well PW-11	Maplewood	0
Well PW-17	Maplewood	1,500
Springbrook Springs	Springbrook Springs	1,050
Well PW-5A	Well PW-5A	1,438

Details regarding the updated pumping rates used and the method of delineation are listed below:

- **Downtown WHPA:** Pumping rates for the Downtown wellfield wells were updated from their annualized annual water right quantity (Q_a) to their instantaneous water right quantity (Q_i) for delineation of the 6-month capture zone. The new 6-month capture zone was delineated using the Renton Groundwater Model (PGG, 1994a; 1994b). The 1-, 5-, and 10-year capture zones for the Downtown wellfield were not updated, however it should be noted that greater uncertainty exists where the capture zones extend under the uplands because the Renton Groundwater Model was calibrated only to water levels in the deltaic and Maplewood Production aquifers.
- **Maplewood WHPA:** Pumping from the Maplewood wellfield was updated to reflect current usage, and therefore in addition to delineating a 6-month capture zone, the 1-, 5-, and 10-year capture zones were re-delineated. The Maplewood wellfield pumping rates were adjusted to account for the limiting water treatment capacity of 3,000 gpm at the Maplewood Treatment Plant. Typically, only one Maplewood well is actively pumping at a time, but as a conservative approach the 2018 capture zones were delineated using the Q_i available at PW-12 and PW-17 for a total wellfield pumping rate of

3,100 gpm. Capture zones were delineated using the Renton Groundwater Model (PGG, 1994a; 1994b). It should be noted that greater uncertainty exists where the capture zones extend under the uplands because the Renton Groundwater Model was calibrated only to water levels in the deltaic and Maplewood Production aquifers. Additionally, the southernmost fingers of the Maplewood 5- and 10-year capture zones extended up to 0.8 miles outside of the model domain. In this area, the capture zones were approximated based on modeled groundwater flow velocities (from the Renton Groundwater Model immediately adjacent to the area) and oriented similar to the known extent of a subsurface bedrock valley.

- Springbrook Springs WHPA: The Springbrook Springs 6-month capture zone was delineated based on the Q_i of the springs. The new capture zone was defined in same manner as the previous 1-, 5-, and 10-year capture zone, which used the Darcy equation with local values for aquifer thickness (50 ft), hydraulic conductivity (75 ft/day), the hydraulic gradient (0.028 ft/ft)², and an assumed aquifer porosity of 0.25 (PGG, 1998). The 1-, 5-, and 10-year capture zones for Springbrook Springs were not updated as part of this work.
- Well PW-5A WHPA: The 6-month capture zone delineated for Well PW-5A is based on its annualized Q_a quantity and defined using the calculated fixed radius method. This is the same way in which the 1-, 5-, and 10-year capture zones were previously delineated (PGG, 1998). For this calculation, the observed screen length (105.5 ft) and an assumed aquifer porosity (0.22) were used.

Capture zones presented in **Figure 1** are plotted in two dimensions, while in reality they occur in the subsurface in three dimensions. The two-dimensional delineation of the Downtown WHPA is likely representative of what is occurring in three dimensions because the deltaic aquifer is not overlain by a shallower aquifer. For the Maplewood WHPA, the 6-month and 1-year capture zones predominately capture water from the deep Maplewood Production aquifer, while the 5- and 10-year capture zones capture significant quantities of water from both the deep and shallow aquifers. Compared to the deltaic aquifer, this suggests that the Maplewood Production aquifer will be less sensitive to land use immediately above its 6-month and 1-year capture zones because the water captured by the production wells is mostly from the deep Maplewood Production aquifer rather than from the shallow water table aquifer (as occurs at the Downtown wellfield). The capture zone delineation methods for Well PW-5A and Springbrook Springs are two-dimensional, and therefore the occurrence of capture in three dimensions from multiple aquifers at these sources has not been further evaluated.

4.0 CONTAMINANT SOURCE INVENTORY & RISK ASSESSMENT

The following sections present an inventory of confirmed and potential sources of contamination located within the updated WHPAs and an evaluation of risks associated with these sources.

² The hydraulic gradient used by PGG (1998) for areas one mile or greater from Springbrook Springs was 0.01 ft/ft, and therefore the 5- and 10-year capture zones were delineated slightly differently from the existing 1-year and newly defined 6-month capture zones.

4.1 DATA SOURCES

Potential contaminant risks that lie within the vicinity of the City's WHPAs were investigated and mapped primarily using data from two sources. The first source is a parcel database created by King County that contains information regarding land use, zoning, sewage handling, and the home heating source for parcels in the county. The second source is data obtained from the Washington State Department of Ecology's Facility / Site Identification (FSID) database, which includes state cleanup sites, federal superfund sites, hazardous waste generators, solid waste facilities and underground storage tanks (USTs). Supplemental information was also obtained from Ecology's Confirmed and Suspected Contaminated Sites database, their UST database, their Toxics Cleanup Program database, and data regarding dry cleaners from Puget Sound Clean Air Agency. Information from these sources was classified and plotted on GIS coverages to assess whether existing and potential contaminant sources were located within the vicinity of Renton's WHPAs³.

4.2 CURRENT LAND USE AND ZONING

King County's database contains a description of the land use within each parcel in the study area. A GIS analysis and database query were used to identify land uses present in the City WHPAs that are thought to pose elevated risk to groundwater. Parcels where such land uses were identified were designated "parcels of possible elevated risk." **Table 1** summarizes County land use categories that are considered to be of concern (primarily based on potential contaminant sources identified by DOH (2010)) and **Table 2** summarizes the individual parcels with those categories within the WHPA.

Figure 2 shows the distribution of zoning throughout the study area, and **Figure 3** provides a close-up of zoning in the Downtown WHPA. It also shows the parcels of possible elevated risk that occur within the City's capture zones as green cross-hatched areas. A summary of the distribution of parcels of possible elevated risk is presented in the table below. In total, 96 parcels of possible elevated risk were identified based on County land use screening codes. Parcels of possible elevated risk that fall within the various capture zones should be considered possible contaminant source locations, with parcels in shorter time of travel zones being more pressing to evaluate for risk management. However, given that some County land-use categories are quite broad, many of these parcels are likely not of significant hazard, and in general these parcels of possible elevated risk are of lower risk than sites with known or potential contaminant sources onsite as identified in Section 4.3.

³ Some locations from Ecology's FSID database were adjusted based on facility address, parcel information, and Google Earth imagery.

Travel Time (years)	Number of Parcels of Concern within WHPA			
	DT	MPW	SBS	5A
0.5	9	4	2	0
1	7	5	1	0
5	31	17	0	3
10	13	3	1	0



Current zoning information from the County’s GIS was also used to evaluate current and future land use in the study area. The following zoning categories are mapped on **Figures 2 and 3**:

- Industrial
- Commercial
- Residential
- Open Space

The Downtown WHPA is primarily zoned commercial, though residential and industrial are also major land use types. The most commonly zoned land use within the Maplewood WHPA is residential, followed by open space. In the Springbrook Springs WHPA, the predominant zoning type is residential, followed by commercial and open space. In the Well PW-5A WHPA, the predominant zoning type is residential, followed by open space. Areas zoned as commercial and industrial are the most likely to comprise threats to groundwater quality.

4.3 CONTAMINANT SOURCES

Table 3 summarizes known environmental sites of potential concern within the Renton WHPAs. As mentioned in the previous section, these sites of potential concern are considered of higher risk than the parcels of possible elevated risk listed in **Table 2**. In total, 85 active contaminant sources of potential concern to the water supply were identified within Renton’s WHPAs. These sites were identified using Ecology’s FSID database. The FSID entries for the Renton area were sorted based on their interaction type, and sites with relevant interaction types were flagged and mapped. Appendix A lists the FSID interaction types that may pose risks to groundwater. Mapped site locations were then verified (and in some cases updated) using a Google Maps address search. **Figures 4 and 5** display the location of each of these sites and indicates through the location symbols which types of activities or risk are associated with each site. Each site marker has three pie slices which indicate the type of activities actively associated with the site as follows:

-  Underground Storage Tank (UST) or Leaky Underground Storage Tank (LUST)
-  Cleanup Site (State Cleanup or Voluntary Cleanup)
-  Hazardous Material Generator or Handler

Any combination of the three indicators is possible. Sites with ongoing cleanup actions have a red circle surrounding the pie to emphasize the risk associated with these facilities.

Site markers without any pie slices filled in indicate the facility is tracked in Ecology’s facilities database, and the facility type is considered to have risk to groundwater, but the facility is not a cleanup site, a hazardous materials handler, nor does it have registered underground storage tanks.

Numerous sites in the Renton area previously were tracked as cleanup sites but have received a No-Further-Action (NFA) determination from Ecology. A NFA letter signifies the site cleanup efforts have met standards in WAC 173-340 and the site does not pose a threat to human health of the environment. Though effective remedial actions have occurred at these sites, residual contaminants that may be present could be mobilized if remedial controls (such as impermeable coverings) are disrupted due to neglect or redevelopment. Therefore, the City should consider continued tracking of NFA sites so that when there is a proposed development on a NFA site, additional review occurs (in the form of reviewing environmental covenants and/or final closure documents for the site) as part of granting a building permit to ensure that the new land use does not inadvertently mobilize residual contaminants. In total, 79 NFA sites are present in the Renton WHPAs and are listed in Appendix B.

4.3.1 Contaminant Sources with Known Releases

Table 3 includes 30 confirmed sites with known active contaminant releases occur in Renton’s WHPAs. Active contaminant release sites are shown on **Figures 4 and 5** with a red circle surrounding their respective contaminant pie. Because the majority of these sites have confirmed groundwater contamination, they pose a higher level of risk to Renton groundwater quality than any other sites identified in this report. Additional information from the Department of Ecology for each active cleanup site tracked by Ecology is provided in Appendix C.

Some sites listed on **Table 3** currently handle hazardous materials or have UST, but previously were cleanup sites and have now received NFA letters from Ecology indicating that the site has been remediated. Where this has occurred, “No Further Action” will be listed under the “Cleanup Status” column on **Table 3**.

4.3.2 Potential Sources

Potential contamination sources within the WHPAs and discussed in this section are based on Ecology’s FSID database, Ecology’s Underground Injection Control (UIC) database, and King County’s parcel database (which includes septic data and home heating oil tank data). The following potential contamination sources have been identified within capture zones for the Renton wells:

- Hazardous materials
- Underground storage tanks
- On-site septic systems
- Home heating oil tanks
- Stormwater
- Agriculture, golf courses, and parks
- Unused and improperly constructed wells
- Transportation corridors
- Pipeline spills

4.3.2.1 Hazardous Materials

The commercial use of chemicals poses a threat to groundwater quality, since chemicals can accidentally spill or be disposed of improperly. The likelihood of such releases from spills can be reduced by proper methods of handling, spill prevention measures, and emergency response strategies. Risk reduction strategies should target on-site handling and waste management practices. Improper disposal is likely the most common pathway for chemicals to be released into the environment. The following facility activity classifications were used to identify sites with hazardous material for this assessment:

FSID Activity Code	Definition
HWG	Facilities that generate any quantity of a dangerous waste. They may be classified as small, medium or large quantity generators (SQG, MQG, or LQG) depending on hazardous waste generated for a given month.
HWP	Under Chapter 173-307 WAC, facilities that report under Section 313 of the Emergency Planning/Community Right-To-Know Act (EPCRA), or that generate more than 2,640 pounds of hazardous waste per year, must prepare Pollution Prevention Plans.
HWOTHER	Facilities that are required to have a RCRA Site ID# but who do not generate and/or manage hazardous waste (XQG generator status). This includes transporters, used oil recycler's, and dangerous waste fuel marketers and burners.
HWTRNSFR	Transfer facility is a site, owned, leased or operated by a transporter of regulated hazardous waste shipments where any of the following occurs: 1) receives wastes from another transporter, 2) transfers wastes from one transport vehicle to another, 3) transfers waste from one container to another, and 4) stores waste within a vehicle or on property for 10 days or less. Examples of transfer facilities include a parking lot, warehouse, truck terminal, barge or steamship loading and unloading facility, or railroad spur loading or unloading facility.
HWTSDF	Facilities that treat store or dispose hazardous waste.
RSVP	The Hazardous Waste and Toxics Reduction Program engages in a variety of field work, site visits, and contacts with sites. While most compliance related activity is recorded into the EPA's RCRAInfo system, the other types of activities are recorded into the Revised Site Visit Program (RSVP).
TIER2	Businesses that store 10,000 pounds or more of a hazardous chemical or 500 pounds or less, depending on the chemical, of an extremely hazardous chemical on site at any one time must report annually. Reports are sent to the State Emergency Response Commission [represented by Ecology], Local Emergency Planning Committees, and local fire departments for emergency planning. [product, not waste]
TRI	Facilities in specific industries that manufacture, process or use more than the threshold amount of one or more of 600 listed toxic chemicals. Most threshold amounts are 10,000 or 25,000 pounds per year. Some chemicals have much lower thresholds.

The most significant threats to groundwater are related to the use and storage of solvents. Solvents are persistent and relatively mobile. A large plume of contamination can be created with a small quantity of solvent.

The FSID database indicates that there are 43 sites within the Renton WHPAs that are active and fall into one of the above hazardous material classifications. These are included in **Tables 3 and 4**, with **Table 4** further identifying the hazardous material classification for each site and whether the site has more than one hazardous material activity occurring

on it. The facility site index database does not indicate whether sites listed are large, medium, or small hazardous waste generators. One site presumably handling hazardous materials but not identified in Ecology database is the Puhich Dry Cleaner Site. This site was observed during the Windshield Survey (described below in Section 4.4) as having several new monitoring wells which suggests possible monitoring for PCE (the most common contaminant associated with dry cleaners). The site was therefore added to **Tables 3 and 4**. The City should contact the owners of Puhich Dry Cleaners to confirm this assumption.

4.3.2.2 Underground Storage Tanks

Contamination in soil and groundwater caused by leaking USTs (“LUSTs”) is a major environmental, legal, and regulatory issue. Common causes of leaks are structural failure, corrosion, improper fittings, improper installation, damage, and natural phenomena. Although USTs are typically used to store flammable motor fuels or heating oils, they may be used for other compounds used by industry, government, or business.

Leakage from USTs and associated piping can often occur without detection. Even relatively small amounts of certain compounds can adversely impact groundwater quality. Once released from an UST, some petroleum products and volatile organic compounds can rapidly migrate to groundwater, a problem that is especially serious in areas with permeable soils or that directly overlie a water supply aquifer.

Of the many materials stored in USTs, solvents are considered the most toxic. However, petroleum products may pose a greater total risk because their use is far more prevalent. In addition, petroleum products contain many potential contaminants, including three EPA priority pollutants: benzene, toluene, and ethylbenzene. Benzene is a known human carcinogen.

Figures 4 and 5 show the locations of USTs in the WHPAs. These sites were identified from Ecology’s UST site data and Toxics Cleanup Program database. Most of these sites exist in areas zoned industrial and commercial. Currently, 34 active USTs facilities located within the wellhead protection capture zones. Of the 34 active UST sites, there are 11 large facilities (>15,000 gallons total volume) in operations (**Table 3**). The tanks at these large facilities have been upgraded to standards developed in the mid-1990’s and include double-walled tanks and leak detection systems. In total, sixteen active LUST sites from the Ecology database are located within the WHPAs.

4.3.2.3 On-Site Septic Systems

On-site septic systems pose a risk to groundwater where they are relatively high in density and/or where hazardous wastes are discharged to them. Potential contaminants from septic systems include pathogenic organisms (bacteria and parasites), toxic substances, contaminants of emerging concern (CECs), and nitrogen compounds.

The extent to which pathogens are transported in the subsurface away from a septic drain field depends on the type of pathogen and the chemical and physical conditions in the subsurface. In general, if a septic system is properly sited, constructed, and maintained, the transport of microorganisms will be limited. Household hazardous chemicals such as cleaners, polishes, waxes, and paints can be transported to groundwater via a septic sys-

tem. Some products contain toxic and persistent chemicals that can cause low-level contamination when coupled with a high density of septic systems. Homeowners may improperly apply or dispose of chemicals because they do not understand the threat they pose to groundwater quality. In some areas, business and commercial facilities use on-site septic systems for sewage disposal. Business, commercial, and industrial operations that utilize on-site systems need to take special precautions to avoid contamination of their wastewater.

Septic systems can also be sources of CECs, which generally are not hazardous chemicals, but can present in wastewater at low concentrations. CECs include pharmaceuticals, personal care products, food additives, cooking products, flame retardants, and various commercially and industrially used compounds. These compounds are not always removed by wastewater treatment plants or septic tanks, and therefore are often detectable in groundwater and surface water. Research into CECs and their potential impact to humans and the environment is ongoing and Ecology, DOH and EPA may periodically adjust their requirements as more becomes known about the risks posed by these contaminants.

Ammonia and nitrate are highly soluble in water and can be expected in detectable quantities wherever portions of an aquifer are affected by septic system discharges. Septic systems are a source of nitrate in groundwater throughout King County. Nitrate is regulated, since ingestion can result in methemoglobinemia, or “blue baby” syndrome. Other sources of nitrate include fertilizers, feedlots, and natural mineral deposits. Background concentrations of nitrate in groundwater are typically less than 1 milligram of nitrogen per liter (mg-N/L). Shallow wells typically are more susceptible to nitrate contamination since they are closer to surficial sources and less aquifer dilution occurs near the water table. The maximum contaminant level (MCL) for nitrate is 10 mg-N/L.

Most of the Renton area is served by sewer systems, however, residents in some local neighborhoods and streets within the WHPAs still rely on septic systems. The King County Assessor’s database indicates if a given property is served by a septic system. Properties with septic systems are plotted on **Figures 2 and 3**. **Table 5** summarizes the distribution of septic systems with the City’s WHPAs and indicates that a total of 1,075 properties within the City WHPAs are on septic systems. The greatest number of septic systems occurs in the Springbrook Springs WHPA, followed by the Maplewood WHPA and the Well PW-5A WHPA. Virtually no septic systems exist in the Downtown WHPA. A comparison of mapped septic parcels to land use zoning areas (**Figures 2 and 3**) suggests that no septic systems are located on properties zoned for commercial or industrial uses.

4.3.2.4 Home Heating Oil Tanks

Data from the King County assessor’s office was obtained regarding the heat source of the primary building located on each parcel. Properties using heating oil were mapped as locations that most likely have home heating oil tanks on site and are shown in **Figures 2 and 3**. In total, 892 parcels with home heating oil tanks are located with the City WHPAs. Most of these parcels (333) are located in the Downtown WHPA, followed by Well PW-5A (275), Springbrook Springs (180), and Maplewood (104) WHPAs.

Home heating oil is a heavier mixture of hydrocarbons and is generally less soluble in water than gasoline. Home heating oil tank leaks are typically more localized than gaso-

line or diesel leaks from service stations since the tanks are significantly smaller and the hydrocarbon mixture is less mobile. Historically, no documented groundwater contamination has occurred in Renton due to home heating oil tank leaks (PGG, 2012). Therefore, based on the smaller quantities and lower mobility of home heating oil in the environment, the risk of contamination to production wells caused by home heating oil tank leaks is considered low, though future leaks causing contamination remain possible. Because the deltaic aquifer is relatively shallow, unconfined, and overlain by a dense distribution of home heating oil tanks, educational outreach to homeowners regarding home heating oil tank maintenance and spill cleanup procedures is recommended within the Downtown wellfield 1-year WHPA.

4.3.2.5 Stormwater

Stormwater (i.e., urban runoff) is produced when rainfall or other precipitation accumulates faster than it can evaporate, be used by plants, or infiltrate to the subsurface. Urban areas produce more runoff than rural areas because they have more impermeable surfaces, such as rooftops, driveways, streets, and highways. Even grass lawns can produce more runoff than forests and pasture.

Stormwater typically contains pollutants, such as sediment, nutrients, bacteria, oils and grease, metals, and other toxics. Many of these contaminants come from air pollution, motor vehicles, application of pesticides and fertilizers, soil erosion, and animal feces. Roofing materials have also been identified as a diffuse source of metals in runoff, particularly zinc (Good, 1993). In general, contaminant concentrations in urban stormwater are similar for all land uses, though slightly higher nitrate concentrations occur in residential areas and higher heavy metals concentrations occur in commercial areas. Concentrated sources of stormwater contamination may also occur if undiluted pollutants (e.g., fertilizer, gasoline, etc) are accidentally spilled or intentionally released and enter storm drains.

Stormwater contamination typically is of concern for surface water pollution because most urban runoff is directed to streams, lakes, and other water bodies with fish and other aquatic life that are highly sensitive to common stormwater contaminants. Infiltration of stormwater generally results in some contaminant treatment, but could still pose risks to groundwater quality depending on the types and concentrations of contaminants present in the stormwater.

Potential Risk from Stormwater

Concern over potential groundwater contamination from stormwater has been recognized by several governmental agencies in western Washington. Stormwater-related impacts to water quality are of particular concern in industrial, commercial, and high-density residential development areas, where runoff volumes can be large. Consequently, stormwater runoff from highways and roads can introduce contaminants such as EPA-priority pollutants (heavy metals and numerous organic compounds), pesticides/herbicides, and coliform bacteria into the groundwater system. Stormwater runoff from lawns and agricultural areas may also introduce nitrate, herbicides, pesticides, and bacterial contaminants.

Stormwater Management in the Renton Area

Stormwater infiltration is prohibited in APA zone 1 and restricted in APA zone 2, and therefore much of the stormwater in Renton is routed to the Cedar River via dedicated a stormwater system. Surface water will generally convey stormwater contaminants outside of City WHPAs, though sediment deposition or local surface water-groundwater interactions may cause stormwater contaminants to locally remain within the WHPAs and/or enter groundwater. Given that the Cedar River is losing adjacent to the Downtown well-field, it is possible that dissolved contaminants within stormwater runoff could enter the City's water supply. Though stormwater contaminants would be greatly diluted in the Cedar River and further diluted in the deltaic aquifer, additional study of this potential contaminant pathway should be considered. Historically, no groundwater contamination attributed to stormwater has been identified at City water supply sources.

Drywells are stormwater handling facilities intended to infiltrate captured stormwater directly into the ground in a shallow well (as compared to a stormwater basin which allows infiltration and evaporation in a shallow depression). Ecology's UIC database was reviewed to identify the location of drywells within the City's WHPAs. Within the UIC database, 12 active drywells were identified. UIC drywell locations are shown in **Figures 2 and 3**. Drywells can provide a shortened pathway for contaminants present in stormwater to reach the uppermost aquifer. Stormwater that is infiltrated through drywells may receive less treatment and filtration than stormwater infiltrating through soils because of this. However, in some cases varying degrees of stormwater treatment may occur via bioswales or through engineered treatment vaults prior to infiltration through a drywell.

In addition to UICs identified by Ecology, 17 additional stormwater infiltration structure locations (provided by the City and King County) within the WHPAs are mapped in **Figures 2 and 3**. Infiltration basins can pose less of a threat to groundwater quality than dry wells since a greater thickness of sediments usually exist between the basin bottom and the water table. However, infiltration basins may infiltrate a larger quantity of water than dry wells, and therefore the relative risk of a dry well versus an infiltration basin should be evaluated on a case-by-case basis.

Lastly, Ecology's FSID database lists sites having general stormwater discharge permits, with categories that include large construction sites, industrial sites, municipal stormwater systems, and WSDOT facilities (listed in Appendix A). General stormwater discharge permits were not included with potential hazards sites based on the reasoning that all sites within a WHPA have stormwater draining to state waters, and therefore stormwater pollution risks are not limited to only large permitted sites.

4.3.2.6 Agriculture, Golf Courses, Parks, and Lawns

Fertilizers, pesticides, and herbicides are applied to residential lawns, commercial landscaping, agricultural lands, and landscaped areas adjacent to roads. If optimally applied, these chemicals pose little threat to groundwater, however, applications are commonly made incorrectly and groundwater contamination can result if agricultural chemicals are applied in exceedance of the agronomic rate. Excess nitrate from fertilizer will be carried in water infiltrating to the underlying groundwater system. Frimpter and others (1990) estimated that an average of 9 pounds of nitrate-N leached annually to groundwater from

each 5,000-square-foot lawn. Landscaping activities can also be the source of pesticides and herbicides.

Residential lawns and other landscaping occur throughout the Renton WHPAs. These are potential sources of nitrogen, pesticides and herbicides to the groundwater. The risk of groundwater contamination by these contaminants is moderate because much of the City's water supply aquifer is overlain by glacial till or confining layers, except for within the Downtown Wellfield WHPA.

Agricultural activities in the Renton WHPAs are limited, though some small farms are located in the Springbrook Springs WHPA in the vicinity of SE 196th St. The application of fertilizer and pesticides/herbicides in agriculture can potentially pose threats to groundwater quality.

Public parks, schools, and sports complexes were all identified within Renton WHPAs, and the application of fertilizers and pesticides/herbicides at these sites can negatively impact groundwater quality. Some of these parks are within wellfield 6-month time of travel zones (such as Liberty Park and Cedar River Park), and therefore the City should coordinate with the parks department on the use of chemicals at facilities in close proximity to wellfields.

The Maplewood Golf Course is located within the Maplewood wellfield 6-month WHPA, and is likely receiving fertilizer, pesticide, and/or herbicide applications. However, the Maplewood wellfield wells are deep (approximately 284 feet bgs to the top of the screened interval) and separated from the surficial aquifer by an aquitard. Historically, the wells have not had a nitrate-N concentration exceeding 0.5 mg/L. Therefore, the risk of nitrate or pesticide/herbicide contamination to the Maplewood wellfield wells is considered low.

4.3.2.7 Unused, and Improperly Constructed Wells

Improperly constructed or abandoned wells pose several potential problems. Unused wells that have not been properly decommissioned can provide a conduit between the ground surface and underlying aquifers. In wells with no surface seal, contaminants introduced near the wellhead can move downward outside the casing to underlying aquifers. Many older wells that were constructed before the implementation of the State's minimum well standards in WAC 173-160 in 1971 have no surface seal. Abandoned wells pose a special risk if they are left without a sealed cap because contaminants can be introduced directly into the aquifer. Unused wells also pose a risk when they are damaged during site redevelopment. Any of these situations can provide a conduit for contaminant movement. An inventory of abandoned wells in the study area is beyond the scope of this project.

4.3.2.8 Transportation Spills

Vehicles transporting hazardous material can be a source of groundwater contamination through accidents and resultant chemical spills. Hazardous materials are transported through Renton on a daily basis. The major transportation routes in the City WHPAs include:

- Interstate 405
- State Route 167/Valley Freeway
- State Route 169
- State Route 900
- State Route 515
- Rainier Avenue
- Grady Way
- Bronson Way/2nd Avenue
- Rail lines (primarily serving the Boeing facility)

All of these transportation corridors go through at least one of the City's WHPAs, with I-405 (the most heavily used route) present in both the Downtown and Well PW-5A WHPAs and is in very close proximity to those supply wells. Historically, a tanker truck overturn on I-405 in 1983 resulted in a relatively small spill (500 gallons) of petroleum product, some of which entered the Cedar River via storm sewer in the vicinity of the Downtown wellfield (PGG, 2012). A major spill along any of these routes could adversely impact groundwater pumped from these supply wells, particularly at the Downtown wellfield since it is shallow and lacks overlying aquitards.

Spill response plans are of critical importance in protecting the City's sources. Response planning should be coordinated between the City, first-responder emergency services (fire, police and state patrol), Ecology and DOH. A formal spill response plan should be regularly updated, and first-responder units should be provided with maps showing the City's APA and WHPA areas to help ensure proper coordination that will protect the water resources in the event of a spill.

4.3.2.9 Pipeline Spills

Several large pipelines exist in the City's WHPAs and have historically had spills associated with them. Pipelines are also at risk to earthquake damage. **Figures 2 and 3** show the locations of the Olympic Pipeline and King County Sewer mainlines.

The Olympic Pipeline (OPL) crosses through the 1 year Maplewood wellfield WHPA and through a small portion of the Downtown wellfield 5 and 10 year WHPAs. In 1986 a failed block valve on the OPL caused approximately 80,000 gallons of petroleum product to leak from the pipeline, which was eventually discovered due to seepage into the Cedar River. Following the installation of over 50 monitoring wells and remediation using numerous air sparge and soil vapor extraction wells (PGG, 2012), the spill site was granted a NFA from Ecology in 2015.

In 2002, a large (42-inch diameter) sanitary sewer trunk line was punctured by a drill rig during construction along the Maple Valley Highway. Approximately 50,000 gallons of sewage and landfill leachate was spilled just north of Cedar River Park in the area between PW-9 and the Henry Moses Aquatic Center, which is within the 6-month WHPA for the Downtown wellfield. However, contaminant migration from this spill was limited

and was only detected in groundwater a few feet from the break and only for a few days following the break (PGG, 2012).

Smaller side sewer pipelines can also pose a potential contamination risk. In 1988 a side sewer line in Cedar River Park near PW-8 was unknowingly broken during the construction of the Renton Community Center, and for several months intermittent coliform hits were detected in nearby PW-8 (PGG, 2012). Though pipeline spills are relatively rare and historically have resulted from malfunctioning equipment or construction damage, if a leak is not identified quickly, the risk of aquifer contamination is greatly increased.

4.4 WINDSHIELD SURVEY FINDINGS

On November 28, 2018 City and PGG personnel performed a windshield survey of sites of interest identified by the City during review of the initial inventory results and those recommended by PGG as a result of our analysis. The sites fell into the following categories:

- High priority sites identified by the City
- Sites with ongoing contaminant cleanups
- Dry cleaners

In total, 30 sites meeting one of the above criteria were visited. Several additional lower priority sites in close proximity to these were also visited. Site names and addresses were confirmed or updated during this process, and general observations and the presence of observed monitoring wells were noted as part of the survey. Cleanup sites and dry cleaners visited during the windshield survey along with associated field notes are listed in **Table 7**. Based on the windshield survey, one additional site (Puhich Dry Cleaners, with map ID 70) was added to the list of sites of potential concern.

4.5 WHPA NOTIFICATION LETTERS

In an effort to protect and coordinate spill response planning within the City's WHPA, notification letters (which presents a WHPA map and describes appropriate procedures in the event of a spill) should be sent to the following entities:

- Parcels of Possible Elevated Risk within WHPAs (**Table 2**)
- Owners of Active Environmental Sites of Potential Concern within WHPAs (**Table D-1**). It should be noted that some overlap exists between **Table 2** and **Table D-1** sites for sites that were identified both as a possible hazard based on land use and a potential hazard based on Ecology data.
- Local Fire and Police Department
- Washington Department of Ecology

Copies of potential notification letters are provided in Appendix D.

5.0 REFERENCES

- City of Renton and Carollo Engineers, 2012. Appendix L Wellhead Protection Plan *in* City of Renton Water System Plan Update 2012.
- Frimpter, M. H., J. J. Donohue, and M. V. Rapacz. 1990. A Mass Balance Nitrate Model for Predicting the Effects of Land Use on Ground-Water Quality, U.S. Geological Survey Open File Report 88-493.
- Good, J. C., 1993. Roof Runoff as a Diffuse Source of Metals and Aquatic Toxicity in Storm Water. *Water Science Technology*, 28(305):317-321.
- Pacific Groundwater Group, 1994a. Renton Groundwater Model Design, Development, and Calibration Final Draft Report. Consultant's report prepared for City of Renton, January, 1994.
- Pacific Groundwater Group, 1994b. Results of Capture Zone Delineation Using Particle Tracking Analysis. Consultant's letter report prepared for City of Renton, January 14, 1994.
- Pacific Groundwater Group, 1998. Capture Zone Delineation. Consultant's letter report prepared for City of Renton, 1998.
- PGG, 2012. Monitoring Well Prioritization and Repairs Phase II Report City of Renton. Consultants report submitted to the City of Renton November 28, 2012.
- Washington State Department of Health (WSDOH), 2010. Washington State Wellhead Protection Program Guidance Document. June 2010. DOH 331-018 (Revised)

Table 1. Summary of Land Use Types of Concern

Land Use Item Code	Land Use Description
104	Retail (Big Box)
122	Medical/Dental Office
130	Farm
137	Greenhouse/Nursery/Horticultural Services
138	Mining/Quarry/Ore Processing
142	Driving Range
143	Golf Course
161	Auto Showroom and Lot
163	Car Wash
168	Convenience Store with Gas
173	Hospital
179	Mortuary/Cemetery/Crematory
186	Service Station
190	Vet/Animal Control Service
194	Mini Lube
195	Warehouse
210	Industrial Park
216	Service Building
223	Industrial (General Purpose)
245	Industrial (Heavy)
246	Industrial (Light)
247	Air Terminal and Hangers
252	Mini Warehouse
266	Utility, Public
276	Historic Prop (Loft/Warehouse)
327	Open Space (Agricultural-RCW 84.34)
343	Gas Station

Notes:

Big box stores (land use item code 104) typically have large back up generators and require fuel storage (particularly stores with large freezer sections) that could result in spills if improperly handled. Lawn & garden supplies such as fertilizer bags also may be stored outside and could result in high nutrient concentrations in runoff.

Several general categories (including warehouse, industrial park, service building, mini warehouse, and historic warehouses) were included they may use or store hazardous chemicals.

Table 2. Summary Data for Parcels of Possible Elevated Risk within Renton Wellhead Protection Areas

Parcel Number	Property Name	Parcel Address	Land-Use Description	WHPA
720003003	Renton Salvation Army Food Bank	206 S TOBIN ST RENTON , WA 98057	Warehouse	DT 5 yr
720003201	AERO PLASTICS	61 SHATTUCK AVE S RENTON , WA 98057	Industrial(Gen Purpose)	DT 5 yr
720010107	SHELL & TACO BELL	300 RAINIER AVE S RENTON , WA 98057	Conv Store with Gas	DT 5 yr
720012608	FIRESTONE STORE	351 RAINIER AVE S RENTON , WA 98057	Auto Showroom and Lot	DT 5 yr
720017300	GOODYEAR TIRE STORE	207 S 3RD ST RENTON , WA 98057	Auto Showroom and Lot	DT 5 yr
720017607	Rebel Fitness	216 S TOBIN ST RENTON , WA 98057	Warehouse	DT 5 yr
720019900	SAFeway GAS SALES	112 S 3RD ST RENTON , WA 98057	Service Station	DT 5 yr
42205900402	SPRINGBOOK FARM	12801 SE 196TH ST , WA 98058	Farm	SBS 10 yr
52205904601	RESIDENCE & GARAGES	19401 102ND AVE SE RENTON , WA 98055	Greenhse/Nrsry/Hort Srvc	SBS 0.5 yr
52205908701	UYETA LANDSCAPE & MAINTENANCE	19605 106TH AVE SE RENTON , WA 98055	Farm	SBS 0.5 yr
72305900101	BOEING RENTON	737 LOGAN AVE N RENTON , WA 98057	Industrial(Heavy)	DT 5 yr
72305900705	RENTON AIRPORT	616 W PERIMETER RD RENTON , WA 98057	Air Terminal and Hangers	DT 1 yr
82305919704	PACCAR PARTS	480 HOUSER WAY N RENTON , WA 98057	Industrial Park	DT 5 yr
135230120507	WAREHOUSE	1655 N 4TH ST RENTON , WA 98057	Warehouse	DT 1 yr
135230122503	WAREHOUSE	1675 N 4TH ST RENTON , WA 98057	Warehouse	DT 5 yr
152305901406	MAPLEWOOD GOLF COURSE	4000 MAPLE VALLEY HWY RENTON , WA 98058	Golf Course	MPW 1 yr
152305916909	MAPLEWOOD GOLF COURSE		Golf Course	MPW 5 yr
162305901801	MAPLEWOOD GOLF COURSE		Golf Course	MPW 0.5 yr
162305904607	STATE OF WASH HWY DEPT	2631 NE 4TH ST RENTON , WA 98056	Warehouse	MPW 10 yr
162305904904	MAPLEWOOD GOLF COURSE		Golf Course	MPW 1 yr
162305906503	MAPLEWOOD GOLF COURSE		Golf Course	MPW 0.5 yr
162305912600	MAPLEWOOD GOLF COURSE		Golf Course	MPW 5 yr
172305902600	STONEWAY SAND & GRAVEL LAND	1915 MAPLE VALLEY HWY RENTON , WA 98057	Industrial(Heavy)	DT 0.5 yr
172305908599	MT OLIVET CEMETARY	100 BLAINE AVE NE RENTON , WA 98056	Mortuary/Cemetery/Crematory	DT 10 yr
172305910603	MT OLIVET CEMETARY		Mortuary/Cemetery/Crematory	DT 10 yr

Table 2. Summary Data for Parcels of Possible Elevated Risk within Renton Wellhead Protection Areas
Renton WHPP Update

Table 2. Summary Data for Parcels of Possible Elevated Risk within Renton Wellhead Protection Areas

Parcel Number	Property Name	Parcel Address	Land-Use Description	WHPA
172305912906	SUNSET CARS	330 SUNSET BLVD N RENTON , WA 98057	Auto Showroom and Lot	DT 1 yr
182305903805	BOB BRIDGE TOYOTA	150 SW 7TH ST RENTON , WA 98057	Auto Showroom and Lot	DT 10 yr
182305904605	BOMA	620 S 7TH ST RENTON , WA 98057	Industrial(Light)	DT 5 yr
182305905602	WAREHOUSE	600 SMITHERS AVE S RENTON , WA 98057	Warehouse	DT 5 yr
182305906303	CAR CLUB INC	250 RAINIER AVE S RENTON , WA 98057	Auto Showroom and Lot	DT 5 yr
182305910008	Office Bldg under construction	60 SW SUNSET BLVD RENTON , WA 98057	Auto Showroom and Lot	DT 10 yr
182305913101	BROWN BEAR CAR WASH/CHEVRON		Car Wash	DT 10 yr
182305913309	BOB BRIDGE OLDSMOBILE	650 RAINIER AVE S RENTON , WA 98057	Auto Showroom and Lot	DT 5 yr
182305919801	WHSE/ OFFICE BUILDING (ASSOC W/9206)	325 BURNETT AVE N RENTON , WA 98057	Industrial(Gen Purpose)	DT 1 yr
182305921203	LITHIA DODGE CHRYSLER	560 HARDIE AVE SW RENTON , WA 98057	Auto Showroom and Lot	DT 5 yr
182305921302	MIDAS MUFFLERS	265 RAINIER AVE S RENTON , WA 98057	Auto Showroom and Lot	DT 5 yr
192305902103	RENTON HONDA		Auto Showroom and Lot	DT 10 yr
192305902509	RENTON COIL SPRING	423 S 7TH ST RENTON , WA 98057	Warehouse	DT 5 yr
192305903101	Car Pros Renton Honda	201 S 7TH ST RENTON , WA 98057	Auto Showroom and Lot	DT 5 yr
192305903507	SOUND FORD	750 RAINIER AVE S RENTON , WA 98057	Auto Showroom and Lot	DT 10 yr
192305904406	LES SCHWAB TIRES	710 RAINIER AVE S RENTON , WA 98057	Auto Showroom and Lot	DT 5 yr
192305905304	Walkers Renton Mazda	720 RAINIER AVE S RENTON , WA 98057	Auto Showroom and Lot	DT 10 yr
192305905403	CHEVRON EXTRA MILE	301 S GRADY WAY RENTON , WA 98057	Conv Store with Gas	DT 10 yr
192305906807	Sound Ford	200 S GRADY WAY RENTON , WA 98057	Auto Showroom and Lot	DT 10 yr
192305907003	ARCO AMPM	710 S GRADY WAY RENTON , WA 98057	Conv Store with Gas	DT 5 yr
192305909207	CAR WASH		Car Wash	DT 5 yr
192305909603	HYUNDAI OF RENTON	700 S GRADY WAY RENTON , WA 98057	Auto Showroom and Lot	DT 5 yr
192305910502	Discount Tire Store	361 S GRADY WAY RENTON , WA 98057	Auto Showroom and Lot	DT 10 yr
212305902307	MAPLEWOOD GOLF COURSE		Golf Course	MPW 0.5 yr
222305900300	MAPLEWOOD GOLF COURSE		Golf Course	MPW 5 yr
222305900805	MAPLEWOOD GOLF COURSE		Golf Course	MPW 1 yr
222305900904	MAPLEWOOD GOLF COURSE		Golf Course	MPW 5 yr

Table 2. Summary Data for Parcels of Possible Elevated Risk within Renton Wellhead Protection Areas
Renton WHPP Update



Table 2. Summary Data for Parcels of Possible Elevated Risk within Renton Wellhead Protection Areas

Parcel Number	Property Name	Parcel Address	Land-Use Description	WHPA
222305901001	MAPLEWOOD GOLF COURSE	4024 MAPLE VALLEY HWY RENTON , WA 98058	Golf Course	MPW 0.5 yr
222305913006	MAPLEWOOD GOLF COURSE		Golf Course	MPW 1 yr
222305914004	MAPLEWOOD GOLF COURSE		Golf Course	MPW 1 yr
222305914103	MAPLEWOOD GOLF COURSE		Golf Course	MPW 5 yr
222305915308	MAPLEWOOD GOLF COURSE		Golf Course	MPW 5 yr
232305921107	CONVENIANCE STORE W/ GAS	15355 MAPLE VALLEY HWY RENTON , WA 98058	Service Station	MPW 5 yr
247300129001	FAIRWOOD GOLF & COUNTRY CLUB		Golf Course	MPW 5 yr
247300142004	FAIRWOOD GOLF & COUNTRY CLUB		Golf Course	MPW 5 yr
247300357008	FAIRWOOD GOLF & COUNTRY CLUB	15100 SE 172ND ST RENTON, WA 98058	Golf Course	MPW 5 yr
247300358006	FAIRWOOD GOLF & COUNTRY CLUB		Golf Course	MPW 5 yr
247300359004	FAIRWOOD GOLF & COUNTRY CLUB		Golf Course	MPW 5 yr
247300360002	FAIRWOOD GOLF & COUNTRY CLUB		Golf Course	MPW 5 yr
247300361000	FAIRWOOD GOLF & COUNTRY CLUB		Golf Course	MPW 5 yr
247320028001	FAIRWOOD GOLF & COUNTRY CLUB		Golf Course	MPW 5 yr
247320029009	FAIRWOOD GOLF & COUNTRY CLUB		Golf Course	MPW 5 yr
247320030007	FAIRWOOD GOLF & COUNTRY CLUB		Golf Course	MPW 5 yr
247337282005	FAIRWOOD GOLF & COUNTRY CLUB		Golf Course	MPW 10 yr
247337285008	FAIRWOOD GOLF & COUNTRY CLUB	17124 151ST AVE SE , WA 98058	Golf Course	MPW 10 yr
334040267000	SOUND FORD	101 SW GRADY WAY RENTON , WA 98057	Auto Showroom and Lot	DT 10 yr
334210323708	SHELL FOOD MART	1410 N 30TH ST RENTON , WA 98056	Conv Store with Gas	5A - 5 yr
334210327105	CHEVRON EXTRA MILE	1419 N 30TH ST RENTON , WA 98056	Conv Store with Gas	5A - 5 yr
334210346402	ARCO FOOD MART	1616 NE 30TH ST RENTON , WA 98056	Conv Store with Gas	5A - 5 yr
380600004507	Gudmundson Company Inc.	102 LAKE AVE S RENTON , WA 98057	Warehouse	DT 5 yr
380600010504	AL MADINA GROCERY	81 S TOBIN ST RENTON , WA 98057	Warehouse	DT 5 yr
569600027605	SHOP/STORAGE & RES	101 BURNETT AVE S RENTON , WA 98057	Warehouse	DT 0.5 yr
662340023206	JOHNSONS WELL DRILLING	19411 108TH AVE SE RENTON , WA 98055	Warehouse	SBS 1 yr

Table 2. Summary Data for Parcels of Possible Elevated Risk within Renton Wellhead Protection Areas
Renton WHPP Update



Table 2. Summary Data for Parcels of Possible Elevated Risk within Renton Wellhead Protection Areas

Parcel Number	Property Name	Parcel Address	Land-Use Description	WHPA
722300001004	PACCAR	485 HOUSER WAY N RENTON , WA 98057	Industrial(Gen Purpose)	DT 1 yr
722400069505	SHELL	401 PARK AVE N RENTON , WA 98057	Conv Store with Gas	DT 1 yr
722930002000	Memory Lane Motors/Muscle Cars	109 S TILlicUM ST RENTON , WA 98057	Warehouse	DT 5 yr
722930010003	WAREHOUSE/OFFICE	235 AIRPORT WAY RENTON , WA 98057	Warehouse	DT 5 yr
722950001007	BROWN BEAR / CHEVRON ASSOCIATED PARKING	77 RAINIER AVE S RENTON , WA 98057	Gas Station	DT 10 yr
722950003003	MINIT LUBE	100 RAINIER AVE S RENTON , WA 98057	Mini Lube	DT 5 yr
723150135009	SERVICE LINEN SUPPLY	903 S 4TH ST RENTON, WA 98507	Industrial(Light)	DT 0.5 yr
723150136007	SERVICE LINEN SUPPLY		Industrial(Light)	DT 0.5 yr
723150137302	SERVICE LINEN		Industrial(Light)	DT 0.5 yr
723150174008	WAREHOUSE	335 WELLS AVE S RENTON , WA 98057	Warehouse	DT 0.5 yr
723150174107	WAREHOUSE	331 WELLS AVE S RENTON , WA 98057	Warehouse	DT 0.5 yr
723150174503	WAREHOUSE	327 WELLS AVE S RENTON , WA 98057	Warehouse	DT 0.5 yr
723150212501	OFFICE/WHSE	107 WILLIAMS AVE S RENTON , WA 98057	Industrial(Gen Purpose)	DT 0.5 yr
756460009506	INDUSTRIAL BUILDINGS	525 GARDEN AVE N RENTON , WA 98057	Warehouse	DT 5 yr
784130001505	RENTON PRINTERy	315 S 3RD ST RENTON , WA 98057	Industrial(Light)	DT 5 yr
784180018003	Vacant Warehouse Bldg	221 MORRIS AVE S RENTON , WA 98057	Warehouse	DT 1 yr
915460000507	CHEVRON HUNGRY BEAR, CAR WASH, XPRESS LUBE	800 S GRADY WAY RENTON , WA 98057	Conv Store with Gas	DT 5 yr
915460017006	IMP IS LOCATED ON MINOR 0005		Conv Store with Gas	DT 5 yr

Notes:

DT = Downtown; MPW = Maplewood; SBS = Springbrook Springs; 5A = Well PW-5A

In most cases, a blank value in the address column indicates the mailing address for the parcel is listed for another parcel with the same property name. However, in a few instances the King County database did not have an associated parcel address for a given property.

Table 3. Summary of Environmental Sites of Potential Concern within Wellhead Protection Areas

Map ID	Facility Name	Facility ID	WHPA Zone	Under Ground Storage Tank (UST)	Leaking UST	Total "Current" Operational Tank Volume (gallons)*	Hazardous Materials	Cleanup Site	Cleanup Status	Halogenated Organic Compounds	Metals Priority Pollutants	Petroleum Products - Unspecified	Petroleum - Other	Petroleum - Gasoline	Petroleum - Diesel	Benzene	Phenolic Compounds	Non Halogenated Solvents	Other Non-Halogenated Organics	Polycyclic Aromatic Hydrocarbons	Conventional Contaminants, Organic	Conventional Contaminants, Inorganic	Metals, Other	Polychlorinated biPhenyls (PCBs)	LUST - Other Hazardous Substance	Lead	Pesticides - Unspecified	Arsenic	Halogenated Solvents		
1	RENTON CITY CCTF	9776647	DT 0.5 yr				Y																								
2	RENTON CITY WELL 9	43699751	DT 0.5 yr				Y																								
3	Shag Cedar River Court Apartments (Cedar River Court Apartments)	12793	DT 0.5 yr					Y	Cleanup Started				C (s)																		
4	RENTON CITY WELL 8	32747884	DT 0.5 yr				Y																								
5	RENTON CITY WELL 1 2 3	65475594	DT 0.5 yr				Y																								
6	Vacant (Tire Store)	24009	DT 0.5 yr					Y	Cleanup Started				C (s)	C (s)																	
7	Pacific NW Bell Switching Station / CenturyLink (Qwest Corporation W00276)	96588161	DT 0.5 yr	Y	Y	1 removed, 1 closed in place, 1 exempt; FSID notes active LUST and inactive UST	Y	Y	Cleanup Started				C (gw), C(s)																		
8	Stoneway Concrete Renton	62244377	DT 0.5 yr					Y	Cleanup Started			C(s)																			
9	ABRA Auto Body & Glass (Taylors Auto Body)	54887792	DT 0.5 yr	Y		2x 111 to 1,100 closed in place (UST database). FSID notes active UST however.	Y	Y	Cleanup Started				C (s)	C (s)		S (s)			C (s)												
10	North American Refractories	82472985	DT 0.5 yr				Y		No Further Action																						
11	SERVICE LINEN SUPPLY INC	12593698	DT 0.5 yr	Y	Y	5 x 111 to 1,100 removed, 1 unknown volume closed in place		Y	Cleanup Started					C (gw), C(s)					C (gw), C(s)						C (gw), C(s)						
12	Shell (Arco 5207)	17426998	DT 1 yr	Y	Y	3 removed, 4 x 10,000 to 19,999 active		Y	Cleanup Started					C (gw), C(s)		C (gw), C(s)															
13	Renton School Dist 403	2066	DT 1 yr	Y		7 removed, 2 x 10,000 to 19,999 active	Y		No Further Action																						
14	Kennys Auto Rebuild Inc	46848442	DT 5 yr				Y																								
15	RENTON SOC 070728	77423621	DT 5 yr	Y		2 with unknown tank status																									
16	PACCAR PARTS NW DISTRIBUTING	82882955	DT 5 yr				Y																								
17	Kenworth Truck Research & Development	5276518	DT 5 yr				Y																								
18	PACCAR MIS	85953633	DT 5 yr	Y		1 closed in place, 1 x 2,001 to 4,999 active	Y		No Further Action																						

Table 3. Summary of Environmental Sites of Potential Concern within Wellhead Protection Areas

Map ID	Facility Name	Facility ID	WHPA Zone	Under Ground Storage Tank (UST)	Leaking UST	Total "Current" Operational Tank Volume (gallons)*	Hazardous Materials	Cleanup Site	Cleanup Status	Halogenated Organic Compounds	Metals Priority Pollutants	Petroleum Products - Unspecified	Petroleum - Other	Petroleum - Gasoline	Petroleum - Diesel	Benzene	Phenolic Compounds	Non Halogenated Solvents	Other Non-Halogenated Organics	Polycyclic Aromatic Hydrocarbons	Conventional Contaminants, Organic	Conventional Contaminants, Inorganic	Metals, Other	Polychlorinated biPhenyls (PCBs)	LUST - Other Hazardous Substance	Lead	Pesticides - Unspecified	Arsenic	Halogenated Solvents		
19	PACIFIC CAR & FOUNDRY CO	2065	DT 5 yr				Y	Y	Construction Complete-Performance Monitoring	C (gw), C(s)	C (gw), C(s)	C(s)					C(s)	C(s)				C(s)	C(s)	C(s)							
20	Boeing 5th & Park Building	85524291	DT 5 yr				Y																								
21	Kelly Moore Paint Co Inc Renton	2509959	DT 5 yr				Y																								
22	Spirit Auto Center of Renton (Sunset Cars; Vacant Property (Pierotti))	5366	DT 5 yr	Y	Y	6 removed. Active LUST per FSID.		Y	Cleanup Started					C(s)	C(s)	C(s)										C(s)					
23	Ero-Dyne Aviation (SKY HARBOR AVIATION)	63051958	DT 5 yr					Y	Awaiting Cleanup			S(gw) C(s)						S(gw) C(s)													
24	Renton Airport	15436	DT 5 yr																												
25	Vacant (SDS Partners)	63618514	DT 5 yr	Y	Y	4 removed. Active UST and LUST per FSID though.		Y	Cleanup Started				C (gw), C(s)																		
26	Gudmundson Co Inc	62661325	DT 5 yr				Y																								
27	Formula-1 Fast Lube (INDY LUBE UST 6799; Formula One Service)	96572525	DT 5 yr	Y	Y	3 removed, 1 closed in place. Active LUST per TCP database.		Y	Cleanup Started				C (s), B(gw)																		
28	Vacant (Dennys Restaurant Rainier Ave)	5970	DT 5 yr	Y	Y	1 with unknown tank status		Y	Cleanup Started							C (gw), C(s)															
29	Gene Meyer Inc	44381644	DT 5 yr				Y																								
30	SUNSET RAINIER RENTON WALGREENS	88647696	DT 5 yr	Y		UST per FSID though			No Further Action																						
31	Safeway Store 1563	5763	DT 5 yr				Y																								
32	Hertz and Lyft Express Drive (Walkers Renton Subaru Used Cars)	19684856	DT 5 yr	Y	Y	3 removed, 3 x 111 to 1,100 of unknown status		Y	Cleanup Started				C (gw), C(s)	C (gw), C(s)	C (gw), C(s)	C (gw), C(s)		C (gw), C(s)													
33	SAFEWAY STORE 1563 FUEL CENTER	2859817	DT 5 yr	Y		1x 10,000 to 19,999, 1 active of unknown volume																									
34	SAFEWAY Fuel Renton	99291269	DT 5 yr	Y	Y	3 removed; FSID notes active UST and LUST however		Y	Cleanup Started				C (gw), C(s)			C (gw), C(s)															
35	RENTON BP	16258354	DT 5 yr	Y		3 removed, 2 x 10,000 to 19,999 active			No Further Action																						
36	Renton Cleaning Center	5888526	DT 5 yr				Y																								

Table 3. Summary of Environmental Sites of Potential Concern within Wellhead Protection Areas

Map ID	Facility Name	Facility ID	WHPA Zone	Under Ground Storage Tank (UST)	Leaking UST	Total "Current" Operational Tank Volume (gallons)*	Hazardous Materials	Cleanup Site	Cleanup Status	Halogenated Organic Compounds	Metals Priority Pollutants	Petroleum Products - Unspecified	Petroleum - Other	Petroleum - Gasoline	Petroleum - Diesel	Benzene	Phenolic Compounds	Non Halogenated Solvents	Other Non-Halogenated Organics	Polycyclic Aromatic Hydrocarbons	Conventional Contaminants, Organic	Conventional Contaminants, Inorganic	Metals, Other	Polychlorinated biPhenyls (PCBs)	LUST - Other Hazardous Substance	Lead	Pesticides - Unspecified	Arsenic	Halogenated Solvents			
37	Fred Meyer Fuel Center No. 459	20819	DT 5 yr	Y		1x 10,000 to 19,999 and 1x 20,000 to 29,999 active																										
38	Verizon Wireless Renton Center	2302487	DT 5 yr				Y																									
39	Latin Market (Renton Clinic Assoc)	94731533	DT 5 yr	Y	Y	LUST per TCP database.		Y	Cleanup Started				C (gw), C(s)																			
40	Salon de Belleza (Scott Drycleaners)	62912812	DT 5 yr					Y	Cleanup Started	C (gw,s)																						
41	BURNETT PARK	9006005	DT 5 yr	Y		1 x 2,001 to 4,999 closure in process																										
42	Car Pros Chrysler Jeep Dodge Ram (Lithia Dodge Chrysler Jeep)	7826317	DT 5 yr					Y	Cleanup Started				C (gw), C(s)	C (gw), C(s)		C (gw), C(s)		C (gw), C(s)								C(gw), S(s)		C(gw), S(s)				
43	Brown Bear (RENTON 1, Brown Bear Car Wash 2422)	27778869	DT 5 yr	Y	Y	3x removed; FSID notes active LUST and inactive UST		Y	Cleanup Started					C (gw), C(s)		C (gw), C(s)		RB(gw), RB(s)														
44	PSE GRADY WAY RENTON COMPLEX PARCEL 3	86541135	DT 5 yr					Y	Cleanup Started		C(gw), R(s)	C(gw), R(s)												S(gw), R(s)								
45	Renton Coil Spring Co. (LTS Trucking, Castagno Brothers)	71914167	DT 5 yr	Y	Y	2 removed; FSID notes active UST, inactive LUST; is an active LUST per TCP database.		Y	Cleanup Started (Site Reopened after 2011 NFA)				C (gw), C(s)																			
46	BROWN BEAR CAR WASH	99851765	DT 5 yr	Y		1 x 10,000 to 19,999 and 1 x 20,000 to 29,999 active																										
47	Bankers Auto Rebuild & Towing	18577466	DT 5 yr				Y																									
48	Arco 5902	47138342	DT 5 yr	Y		4 x 10,000 to 19,999 active			No Further Action																							
49	PSE GRADY WAY RENTON COMPLEX PARCEL 2	21349929	DT 5 yr					Y	Cleanup Started		C(gw), R(s)	C(gw), R(s)												S(gw), R(s)								
50	Kenworth Truck R&D	9167239	DT 10 yr																													
51	PSE Boeing Renton #2 Substation	13138	DT 10 yr				Y																									
52	KENWORTH TRUCK CO RENTON	13289817	DT 10 yr				Y																									
53	Car Wash Enterprises CWE Renton	4474679	DT 10 yr	Y		4x removed, 3 x 10,000 to 19,999 active			No Further Action																							
54	King Cnty Solid Waste Div Renton Tran	62379615	DT/MPW 10 yr				Y																									

Table 3. Summary of Environmental Sites of Potential Concern within Wellhead Protection Areas

Map ID	Facility Name	Facility ID	WHPA Zone	Under Ground Storage Tank (UST)	Leaking UST	Total "Current" Operational Tank Volume (gallons)*	Hazardous Materials	Cleanup Site	Cleanup Status	Halogenated Organic Compounds	Metals Priority Pollutants	Petroleum Products - Unspecified	Petroleum - Other	Petroleum - Gasoline	Petroleum - Diesel	Benzene	Phenolic Compounds	Non Halogenated Solvents	Other Non-Halogenated Organics	Polycyclic Aromatic Hydrocarbons	Conventional Contaminants, Organic	Conventional Contaminants, Inorganic	Metals, Other	Polychlorinated biPhenyls (PCBs)	LUST - Other Hazardous Substance	Lead	Pesticides - Unspecified	Arsenic	Halogenated Solvents		
55	King County Dept of Transportation - 155 Monroe Ave NE	21295	DT/MPW 10 yr																												
56	KING CNTY DPW RENTON FACILITY	32954817	DT/MPW 10 yr				Y		No Further Action																						
57	KING CO REGIONAL COMM AND EMERGENCY COORD CTR	24298	DT/MPW 10 yr				Y																								
58	Fred Meyer Stores Inc Renton	12107	DT 10 yr				Y																								
59	Fred Meyer UST 7842 (SEARS ROEBUCK & CO UST 7842)	60178828	DT 10 yr	Y	Y	1x removed; however FSID notes active LUST and UST		Y	Cleanup Started						C (gw), C(s)																
60	Wal Mart 2516	37352136	DT 10 yr				Y																								
61	Vacant (Sound Ford)	58499353	DT 10 yr					Y	Cleanup Started				C(s), S(gw)	C (gw), C(s)		C(s), S(gw)															
62	Mini Mart/ Mobil Gas Station (USA MINI MART 115)	94569877	DT 10 yr	Y	Y	6 x removed, 2 active of unknown size; FSID notes active LUST & UST	Y	Y	Cleanup Started					C(s), S(gw)		C(s), S(gw)			C(s), S(gw)												
63	Texaco Station 632320402	3238112	DT 10 yr	Y	Y	3 x removed; FSID notes active LUST and inactive UST		Y	Cleanup Started		C(gw), B(s)		C (gw), C(s)	C (gw), C(s)		C (gw), C(s)										C (gw), C(s)	C (gw), C(s)				
64	Walkers Renton MAZDA	18869255	DT 10 yr				Y																								
65	CHEVRON 99114	77287947	DT 10 yr	Y	Y	6 x removed, 3 x 10,000 to 19,999 active; FSID notes active LUST & UST	Y	Y	Cleanup Started					C (gw), C(s)		C (gw), C(s)															
66	Renton Village Cleaners (Renton Village Dry Cleaners)	4484368	DT 10 yr				Y	Y	Cleanup Started							C (gw), C(s)															
67	Rite Aid #5201	20396	DT 10 yr				Y																								
68	Allied Battery Co Inc Renton	5884609	DT 10 yr				Y																								
69	AIRTOUCH CELLULAR SOUTH CENTER	71676937	DT 10 yr				Y																								
70	Puhich Dry Cleaners^	5971	DT 0.5 yr				Y																								
71	MAPLEWOOD MAINTENANCE SHOP	64293294	MPW 5 yr	Y		1 removed, 1 x 111 to 1,100 active			No Further Action																						
72	RENTON CITY WATER DEPT	75784645	MPW 5 yr				Y																								
73	VERIZON WIRELESS WARE MAPLEWOOD	19828	MPW 5 yr				Y																								

Table 3. Summary of Environmental Sites of Potential Concern within Wellhead Protection Areas

Map ID	Facility Name	Facility ID	WHPA Zone	Under Ground Storage Tank (UST)	Leaking UST	Total "Current" Operational Tank Volume (gallons)*	Hazardous Materials	Cleanup Site	Cleanup Status	Halogenated Organic Compounds	Metals Priority Pollutants	Petroleum Products - Unspecified	Petroleum - Other	Petroleum - Gasoline	Petroleum - Diesel	Benzene	Phenolic Compounds	Non Halogenated Solvents	Other Non-Halogenated Organics	Polycyclic Aromatic Hydrocarbons	Conventional Contaminants, Organic	Conventional Contaminants, Inorganic	Metals, Other	Polychlorinated biPhenyls (PCBs)	LUST - Other Hazardous Substance	Lead	Pesticides - Unspecified	Arsenic	Halogenated Solvents		
74	KING COUNTY PARKS	34837919	MPW 10yr				Y																								
75	RENTON HIGHLANDS LANDFILL	2128	MPW 10yr					Y	Awaiting Cleanup												S (s)	S (s)									
76	King Cnty DOT Road Services Div	41149477	MPW 10yr				Y																								
77	FAIRWOOD GOLF & COUNTRY CLUB	43989944	MPW 10yr	Y		2 x 111 to 1,100 active																									
78	RENTON CITY SPRING BROOK SPRINGS	76461781	SPS 0.5 yr				Y																								
79	Panther Lake Shopping Center	17428	SPS 1 yr					Y	Cleanup Started																					C (s)	
80	Rite Aid #5189	7155	SPS 1 yr				Y																								
81	Allied Waste Service Kent	1247957	SPS 5 yr																												
82	SOOS CREEK WATER & SEWER DISTRICT	24788111	SPS 10 yr	Y		1 x 111 to 1,100 active																									
83	Kennydale Chevron	74465899	5A 5 yr	Y		1 removed, 4 active of unknown size	Y		No Further Action																						
84	KENNYDALE FUEL	3538	5A 5 yr	Y		2 x removed, 2 x 10,000 to 19,999 active			No Further Action																						
85	Shell Station 120646	48271835	5A 5 yr	Y		4 x removed, 3 x 10,000 to 19,999 active			No Further Action																						

General Table Notes

WHPA = Wellhead Protection Area; DT = Downtown; MPW = Maplewood; SBS = Springbrook Springs; 5A = Well PW-5A

The 5 and 10 year WHPAs for the Downtown and Maplewood well fields overlap; if a hazardous site is located where the WHPAs overlap, the WHPA is denoted as DT/MPW.

Facility names in parentheses indicates that a site was visited during the windshield survey and it has a different name from the FSID facility name (which is in parentheses). Facility names with no parentheses in their entry use the FSID facility name.

If a site does not have a UST, hazardous materials, or cleanup present (or historically present) on it, it has been flagged due to other factors that increase the risk of groundwater contamination.

^Puhich Dry Cleaners (Map ID 70) was not listed in the FSID database, but was observed during the windshield survey and it is suspected that hazardous materials are used at the site.

*Tank size and status information is from Ecology's UST database. In some instances information from the FSID database was inconsistent with data from the UST database and/or Ecology's Toxics Cleanup Program (TCP) database; notations have been included for sites where this occurs.

"No Further Action" is listed for sites that were cleaned up and granted a No Further Action determination from Ecology, but remain potential contamination sources due to current land use.

Cleanup Site Contaminants and Media Notes (provided from Ecology's online Site Summary Report)

- B Below Cleanup Level
- C Confirmed Above Cleanup Level
- S Suspected
- R Remediated
- RA Remediated-Above Cleanup Level
- RB Remediated-Below Cleanup Level
- (gw) Groundwater
- (sw) Surface Water
- (s) Soil

Table 4. Active Hazardous Materials Sites in Renton WHPAs

Active Hazardous Material Sites					
Map ID	FSID	Facility Name	Facility Address	Activity Code	WHPA
1	9776647	RENTON CITY CCTF	1715 SE MAPLE VALLEY HWY	TIER2	DT 0.5 yr
2	43699751	RENTON CITY WELL 9	1707 SE MAPLE VALLEY HWY	TIER2	DT 0.5 yr
4	32747884	RENTON CITY WELL 8	1703 SE MAPLE VALLEY HWY	TIER2	DT 0.5 yr
5	65475594	RENTON CITY WELL 1 2 3	1398 HOUSER WAY N	TIER2	DT 0.5 yr
7	96588161	Pacific NW Bell Switching Station / CenturyLink (Qwest Corporation W00276)	225 WILLIAMS AVE S	HWOTHER	DT 0.5 yr
7	96588161	Pacific NW Bell Switching Station / CenturyLink (Qwest Corporation W00276)	225 WILLIAMS AVE S	TIER2	DT 0.5 yr
9	54887792	ABRA Auto Body & Glass (Taylors Auto Body)	330 MAIN AVE S	HWG	DT 0.5 yr
10	82472985	North American Refractories	1500 HOUSER WAY S	TIER2	DT 0.5 yr
13	2066	Renton School Dist 403	1220 N 4TH ST	TIER2	DT 1 yr
14	46848442	Kennys Auto Rebuild Inc	618 Park Ave N	HWG	DT 5 yr
16	82882955	PACCAR PARTS NW DISTRIBUTING	502 HOUSER WAY N	TIER2	DT 5 yr
17	5276518	Kenworth Truck Research & Development	485 HOUSER WAY N	HWG	DT 5 yr
17	5276518	Kenworth Truck Research & Development	485 HOUSER WAY N	TIER2	DT 5 yr
18	85953633	PACCAR MIS	480 HOUSER WAY N	TIER2	DT 5 yr
19	2065	PACIFIC CAR & FOUNDRY CO	1400 N 4TH ST	HWOTHER	DT 5 yr
20	85524291	Boeing 5th & Park Building	500 PARK AVE N GARAGE BLDG 1013 & 1016	HWG	DT 5 yr
21	2509959	Kelly Moore Paint Co Inc Renton	350 Sunset Blvd N Ste C	HWOTHER	DT 5 yr
26	62661325	Gudmundson Co Inc	102 LAKE AVE S	HWOTHER	DT 5 yr
29	44381644	Gene Meyer Inc	225 RAINIER AVE S	HWOTHER	DT 5 yr
31	5763	Safeway Store 1563	200 S 3rd St	HWG	DT 5 yr
36	5888526	Renton Cleaning Center	364 RENTON CTR WAY SW	HWG	DT 5 yr
38	2302487	Verizon Wireless Renton Center	450 SHATTUCK AVE S	TIER2	DT 5 yr
47	18577466	Bankers Auto Rebuild & Towing	405 S 7TH ST	HWG	DT 5 yr
51	13138	PSE Boeing Renton #2 Substation	704 Logan Ave N	TIER2	DT 10 yr
52	13289817	KENWORTH TRUCK CO RENTON	1601 N 8TH ST	TIER2	DT 10 yr
52	13289817	KENWORTH TRUCK CO RENTON	1601 N 8TH ST	TRI	DT 10 yr
52	13289817	KENWORTH TRUCK CO RENTON	1601 N 8TH ST	HWP	DT 10 yr
52	13289817	KENWORTH TRUCK CO RENTON	1601 N 8TH ST	HWG	DT 10 yr
54	62379615	King Cnty Solid Waste Div Renton Tran	3021 NE 4TH ST	HWOTHER	DT/MPW 10 yr
56	32954817	KING CNTY DPW RENTON FACILITY	155 MONROE AVE NE	TIER2	DT/MPW 10 yr
57	24298	KING CO REGIONAL COMM AND EMERGENCY COORD CTR	3511 NE 2ND ST	TIER2	DT/MPW 10 yr
58	12107	Fred Meyer Stores Inc Renton	365 Renton Center Way SW	HWG	DT 10 yr

Table 4. Active Hazardous Materials Sites in Renton WHPAs
Renton WHPP Update



Table 4. Active Hazardous Materials Sites in Renton WHPAs

Active Hazardous Material Sites					
Map ID	FSID	Facility Name	Facility Address	Activity Code	WHPA
58	12107	Fred Meyer Stores Inc Renton	365 Renton Center Way SW	RSVP	DT 10 yr
60	37352136	Wal Mart 2516	743 RAINIER AVE S	HWP	DT 10 yr
60	37352136	Wal Mart 2516	743 RAINIER AVE S	HWG	DT 10 yr
62	94569877	Mini Mart/ Mobil Gas Station (USA MINI MART 115)	765 RAINIER AVE S	TIER2	DT 10 yr
64	18869255	Walkers Renton MAZDA	200 S GRADY WAY	HWG	DT 10 yr
65	77287947	CHEVRON 99114	301 S GRADY WAY	HWOTHER	DT 10 yr
66	4484368	Renton Village Cleaners (Renton Village Dry Cleaners)	601 S Grady Way	HWOTHER	DT 10 yr
67	20396	Rite Aid #5201	601 S Grady Way Ste P	HWG	DT 10 yr
68	5884609	Allied Battery Co Inc Renton	55 SW 12TH	TIER2	DT 10 yr
69	71676937	AIRTOUCH CELLULAR SOUTH CENTER	15 S GRADY WAY	TIER2	DT 10 yr
72	75784645	RENTON CITY WATER DEPT	4030 MAPLE VALLEY HWY	TIER2	MPW 5 yr
73	19828	VERIZON WIRELESS WARE MAPLEWOOD	15214 149TH AVE SE	TIER2	MPW 5 yr
74	34837919	KING COUNTY PARKS	3005 NE 4TH	HWG	MPW 10 yr
76	41149477	King Cnty DOT Road Services Div	155 MONROE AVE NE BLDG P G F	TIER2	MPW 10 yr
76	41149477	King Cnty DOT Road Services Div	155 MONROE AVE NE BLDG P G F	HWP	MPW 10 yr
76	41149477	King Cnty DOT Road Services Div	155 MONROE AVE NE BLDG P G F	HWG	MPW 10 yr
78	76461781	RENTON CITY SPRING BROOK SPRINGS	5750 TALBOT RD S	TIER2	SBS 0.5 yr
80	7155	Rite Aid #5189	20518 108th Ave SE	HWG	SBS 1 yr
83	74465899	Kennydale Chevron	1419 N 30TH ST	HWG	5A 5 yr

Notes:

DT = Downtown; MPW = Maplewood; SBS = Springbrook Springs; 5A = Well PW-5A

The 5 and 10 year WHPAs for the Downtown and Maplewood well fields overlap; if a hazardous site is located where the WHPAs overlap, the WHPA is denoted as DT/MPW.

Facility names in parentheses indicates that a site was visited during the windshield survey and it has a different name from the FSID facility name (which is in parentheses). Facility names with no parentheses in their entry use the FSID facility name.

HWG = facility generates hazardous waste.

HWP = facility generates over 2640 lbs hazardous waste per year.

TIER 2 = facility stores 10,000 pounds or more of a hazardous chemical, or 500 pounds or less (depending on the chemical) of an extremely hazardous chemical on site at any one time.

TRI = facility manufactures, processes or uses more than the threshold amount of one or more of 600 listed toxic chemicals. Most threshold amounts are 10,000 or 25,000 pounds per year. Some chemicals have much lower thresholds.

HWOTHER = Facility does not generate or manage hazardous waste, but includes transporters of hazardous waste, used oil recyclers, and dangerous waste fuel marketers & burners.

Table 5. Distribution of Septic Systems within City of Renton WHPAs

WHPA	DT	MPW	SBS	5A
6-month	0	58	2	10
1-year	0	35	10	20
5-year	0	104	131	107
10-year	2	152	285	159
total in WHPA	2	349	428	296

Notes:

DT = Downtown; MPW = Maplewood; SBS = Springbrook Springs; 5A = Well PW-5A

Septic system counts presented in this table are approximate because large parcels overlapping two time-of-travel zones are counted in both.

Table 6. Distribution of Home Heating Oil Tanks within City of Renton WHPAs

WHPA	DT	MPW	SBS	5A
6-month	127	33	4	26
1-year	28	15	52	22
5-year	143	51	40	90
10-year	35	5	84	137
total in WHPA	333	104	180	275

Notes:

DT = Downtown; MPW = Maplewood; SBS = Springbrook Springs; 5A = Well PW-5A

Home heating oil counts presented in this table are approximate because large parcels overlapping two time-of-travel zones are counted in both.

The 5 year DT WHPA overlaps the 1 and 5 year MPW WHPAs. Because the time of travel to the MPW wellfield is less than or equal to the time of travel to the DT wellfield, home heating oil tanks in this overlapping region were counted only as part of the MPW WHPAs.

Table 7. Visited Windshield Survey Cleanup Sites

Visit rationale	Map ID	Facility Name	Facility Address	WHPA Zone	Leaking UST	Hazardous Materials
Active Cleanup Site	3	Shag Cedar River Court Apartments (Cedar River Court Apartments)	130 MAIN AVE S	DT 0.5 yr		
	6	Vacant (Tire Store)	205 LOGAN AVE S	DT 0.5 yr		
	7	Pacific NW Bell Switching Station / CenturyLink (Qwest Corporation W00276)	225 WILLIAMS AVE S	DT 0.5 yr	Y	Y
	8	Stoneway Concrete Renton	1915 SE MAPLE VALLEY HWY	DT 0.5 yr		
	9	ABRA Auto Body & Glass (Taylors Auto Body)	330 MAIN AVE S	DT 0.5 yr		Y
	11	SERVICE LINEN SUPPLY INC	903 S 4TH ST	DT 0.5 yr	Y	
	12	Shell (ARCO 5207)	401 PARK AVE N	DT 1 yr	Y	
	19	PACIFIC CAR & FOUNDRY CO	1400 N 4TH ST	DT 5 yr		Y
	22	Spirit Auto Center of Renton (Sunset Cars; Vacant Property (Pierotti))	330 Sunset Blvd N	DT 5 yr	Y	
	23	Ero-Dyne Aviation (SKY HARBOR AVIATION)	300 AIRPORT WAY S	DT 5 yr		
	25	Vacant (SDS Partners)	307 AIRPORT WAY	DT 5 yr	Y	
	27	Formula-1 Fast Lube (INDY LUBE UST 6799; Formula One Service)	100 RAINIER AVE S	DT 5 yr	Y	
	28	Vacant (Dennys Restaurant Rainier Ave)	144 RAINIER AVE S	DT 5 yr	Y	
	32	Hertz and Lyft Express Drive (Walkers Renton Subaru Used Cars)	250 RAINIER AVE S	DT 5 yr	Y	
	34	SAFEWAY Fuel Renton	112 S 3RD ST	DT 5 yr	Y	
	39	Latin Market (Renton Clinic Assoc)	215 S 4TH PL	DT 5 yr	Y	
	40	Salon de Belleza (Scott Drycleaners)	201 S 4TH PL	DT 5 yr		
	42	Car Pros Chrysler Jeep Dodge Ram (Lithia Dodge Chrysler Jeep)	585 RAINIER AVE S	DT 5 yr		
	43	Brown Bear (RENTON 1, Brown Bear Car Wash 2422)	621 & 641 RAINIER AVE S	DT 5 yr	Y	
	44	PSE GRADY WAY RENTON COMPLEX PARCEL 3	915 S GRADY WAY	DT 5 yr		
	45	Renton Coil Spring Co. (LTS Trucking, Castagno Brothers)	423 S 7TH ST	DT 5 yr	Y	
	49	PSE GRADY WAY RENTON COMPLEX PARCEL 2	915 S GRADY WAY	DT 5 yr		
	59	Fred Meyer UST 7842 (SEARS ROEBUCK & CO UST 7842)	359 RENTON CENTER WAY SW	DT 10 yr	Y	
61	Vacant (Sound Ford)	750 RAINIER AVE S	DT 10 yr			
62	Mini Mart/ Mobil Gas Station (USA MINI MART 115)	765 RAINIER AVE S	DT 10 yr	Y	Y	

Table 7. Visited Windshield Survey Sites
Renton WHPA Update



Table 7. Visited Windshield Survey Cleanup Sites

Visit rational	Map ID	Facility Name	Facility Address	WHPA Zone	Leaking UST	Hazardous Materials
Active Cleanup Site	63	Texaco Station 632320402	509 S GRADY WAY	DT 10 yr	Y	
	65	CHEVRON 99114	301 S GRADY WAY	DT 10 yr	Y	Y
	66	Renton Village Cleaners (Renton Village Dry Cleaners)	601 S Grady Way	DT 10 yr		Y
	75	RENTON HIGHLANDS LANDFILL	NE 3RD ST & NE 4TH ST	MPW 10yr		
	79	Panther Lake Shopping Center	20610 108TH AVE SE	SPS 1 yr		
Dry Cleaner	70	Puhich Dry Cleaners	319 Main Ave S	DT 0.5 yr		Y
	36	Renton Cleaning Center	364 RENTON CTR WAY SW	DT 5 yr		Y

General Table Notes

WHPA = Wellhead Protection Area; DT = Downtown; MPW = Maplewood; SBS = Springbrook Springs; 5A = Well PW-5A

Facility names in parentheses indicates that a site was visited during the windshield survey and it has a different name from the FSID facility name (which is in parentheses). Facility names with no parentheses in their entry use the FSID facility name.

This table lists cleanup sites and dry cleaners visited as part of the windshield survey. Several sites from the City's APA database neighboring the cleanup sites were also visited during the windshield survey, but are not included in this table.

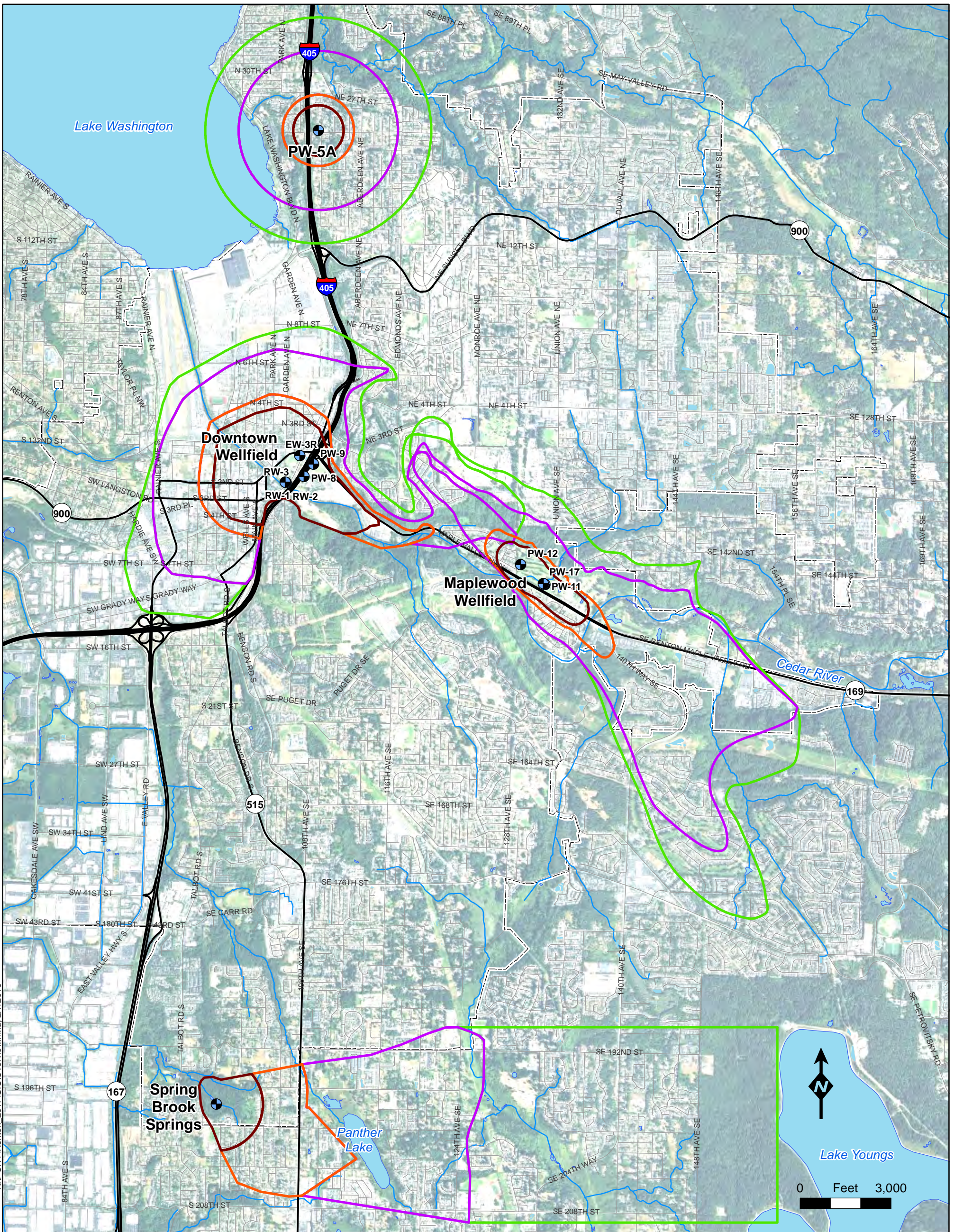

K:\PONY\Renton_2017\GIS\Overview.mxd_2/7/2019

- City of Renton Production Well or Spring
- City Limits
- 2018 Capture Zones**
- 6-Month
- 1-Year
- 5-Years
- 10-Years

Figure 1
 City of Renton 2018
 Wellhead Protection
 Area Capture Zones

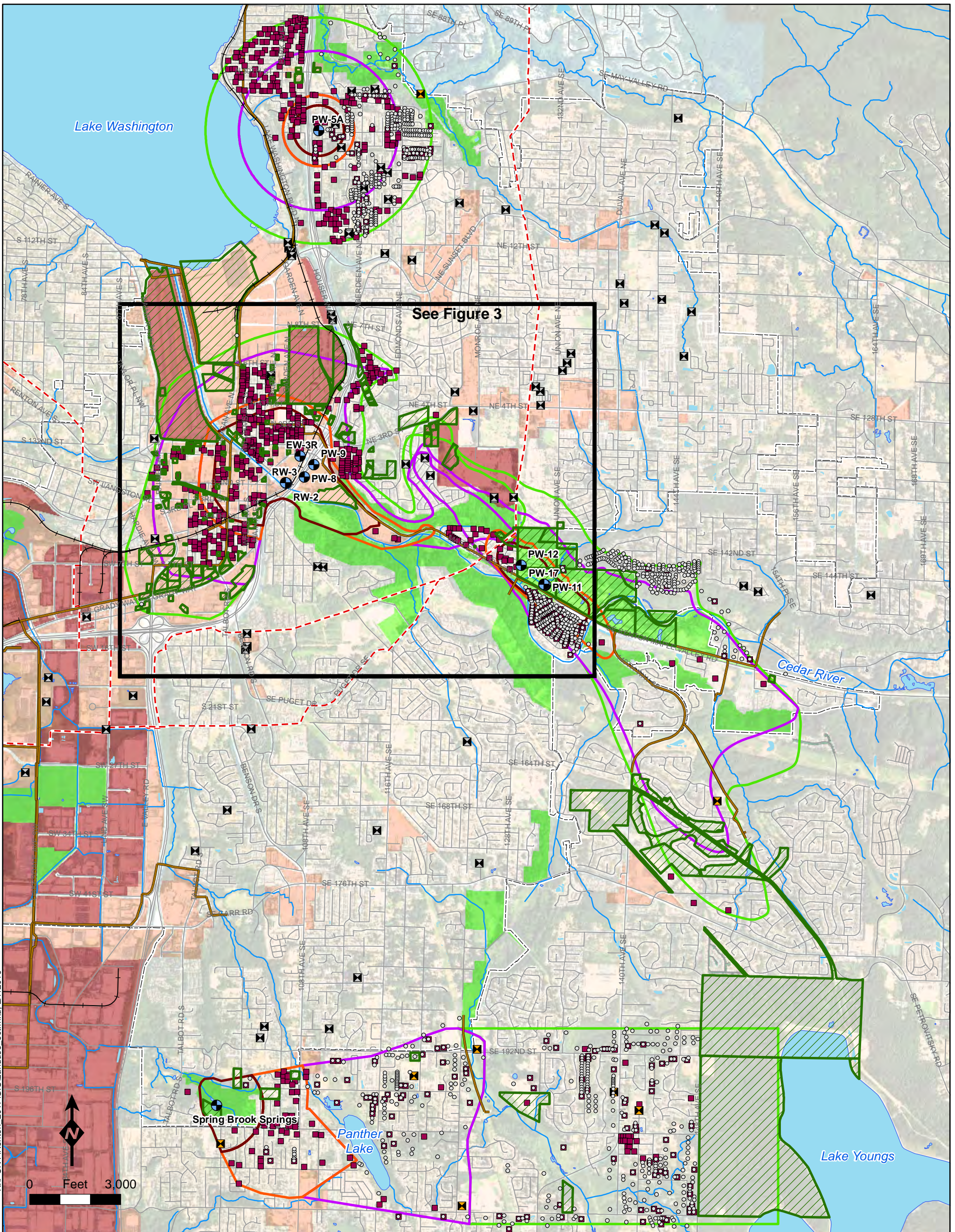

K:\PONY\Renton_2017\GIS\Landuse_ect.mxd_2/7/2019

See Figure 3

Spring Brook Springs

Panther Lake

Lake Youngs



- City of Renton Production Well or Spring
- Septic Systems (King County Assessor)
- Stormwater Detention Facilities with Infiltration (from City of Renton and County)
- Active UIC Drywells (Ecology 2018)
- Buildings with Oil Heat (King County Assessor)
- Parcels of Possible Elevated Risk (Current Land Use from King County)
- King County Sewer Mainlines
- Olympic Pipeline
- Rail Lines
- City Limits

- Generalized Zoning**
- Open Space
- Residential
- Commercial
- Industrial
- Capture Zones**
- 6-Month
- 1-Year
- 5-Years
- 10-Years

Figure 2
Zoning and Parcels of Possible Elevated Risk Within Renton WHPAs

Figure 3
Zoning and
Parcels of Possible
Elevated Risk Within
Downtown WHPA

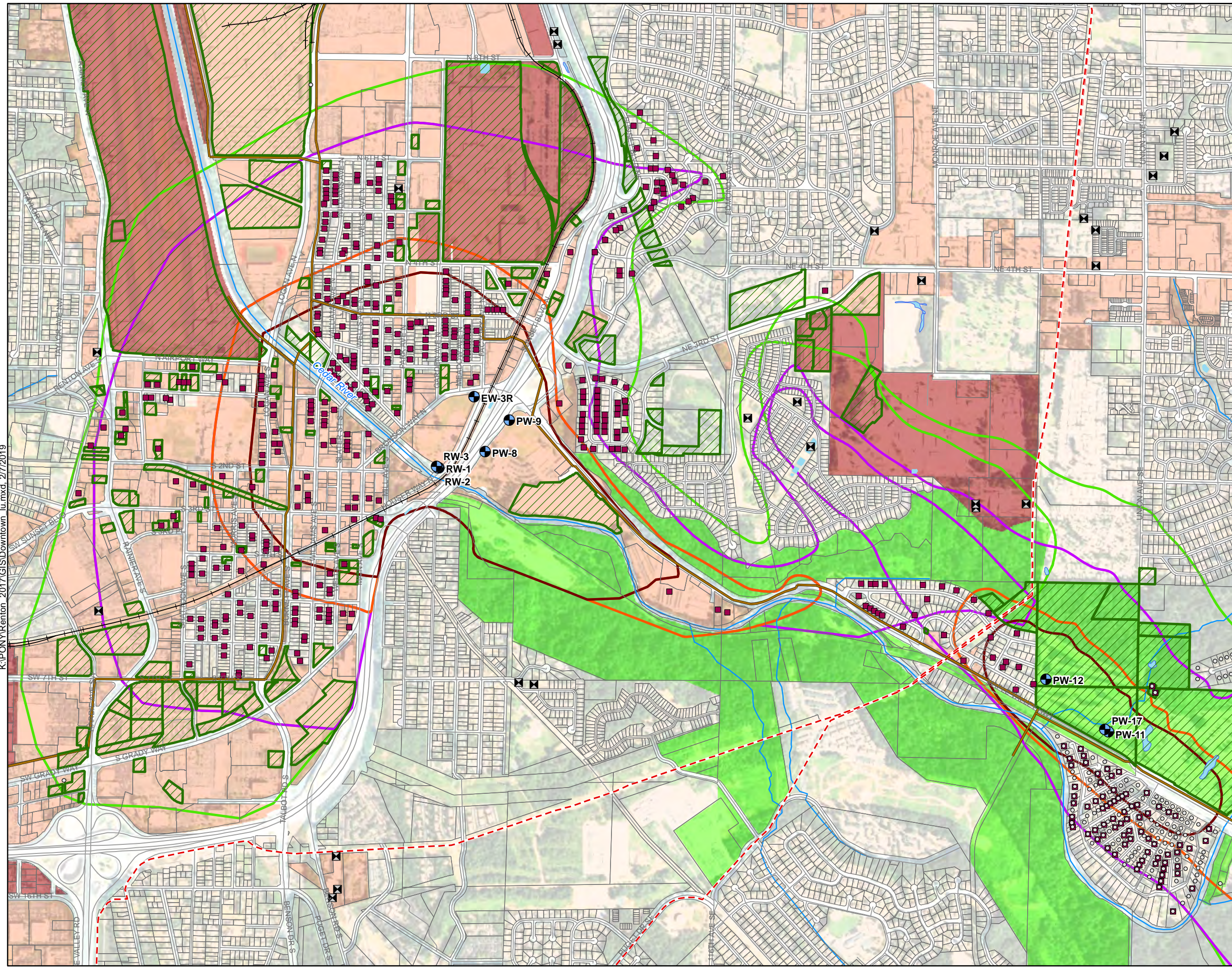

- City of Renton Production Wells
- Septic Systems (King County Assessor)
- Active UIC Drywells (Ecology 2018)
- Detention Facilities with Infiltration (from City of Renton and County)
- Buildings with Oil Heat (King County Assessor)
- Parcels of Possible Elevated Risk (Current Land Use from King County)
- King County Sewer Mainlines
- Olympic Pipeline
- Rail Lines
- Generalized Zoning**
- Open Space
- Residential
- Commercial
- Industrial
- Capture Zones**
- 6-Month
- 1-Year
- 5-Years
- 10-Years

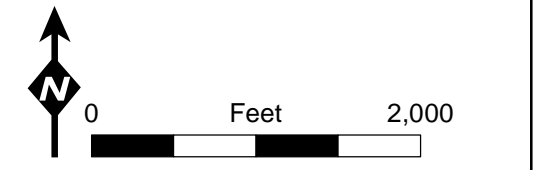

K:\PONY\Renton_2017\GIS\Downtown.lu.mxd, 2/7/2019

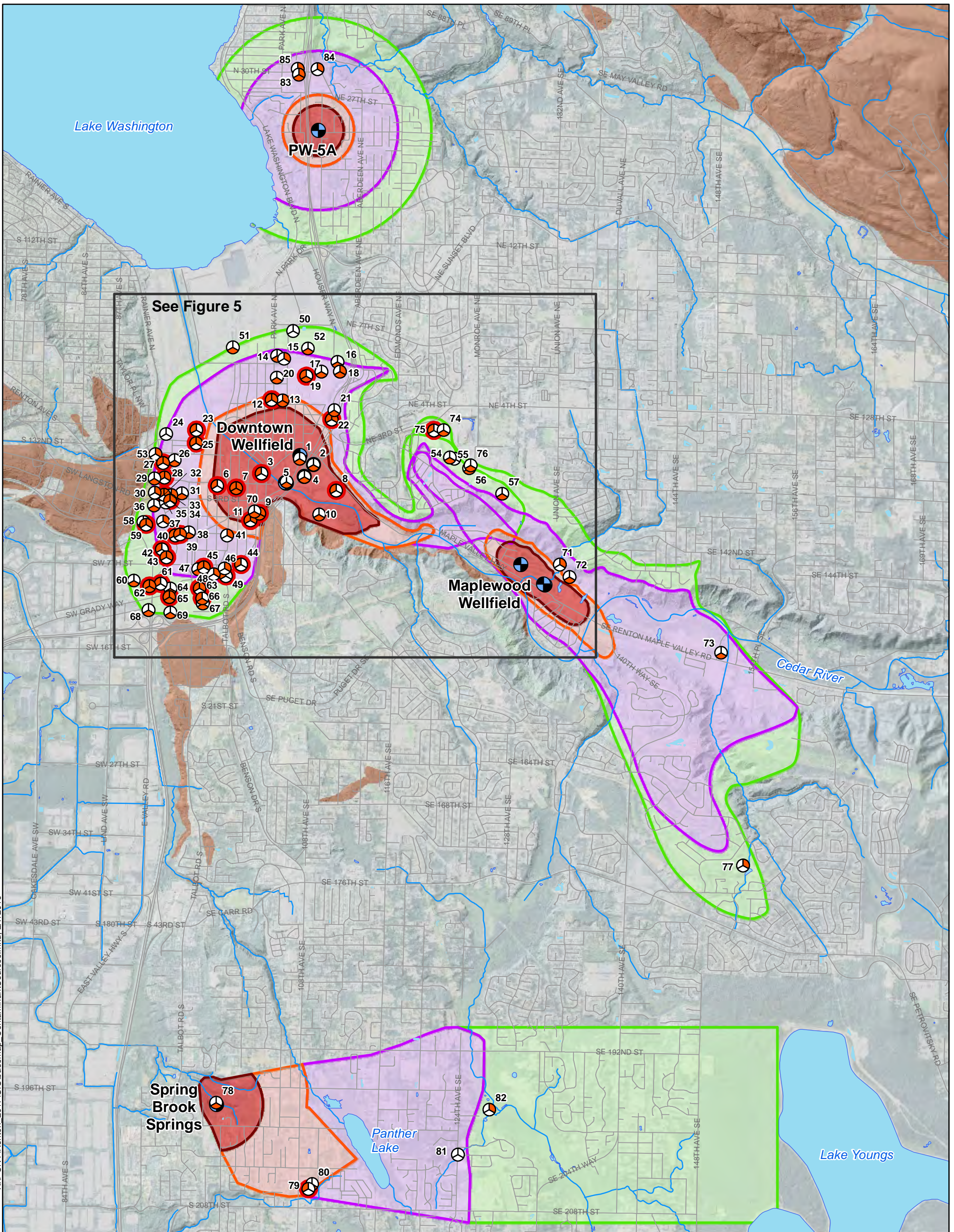

K:\PONY\Renton_2017\GIS\basemap_ContaminantSources.mxd_2/7/2019

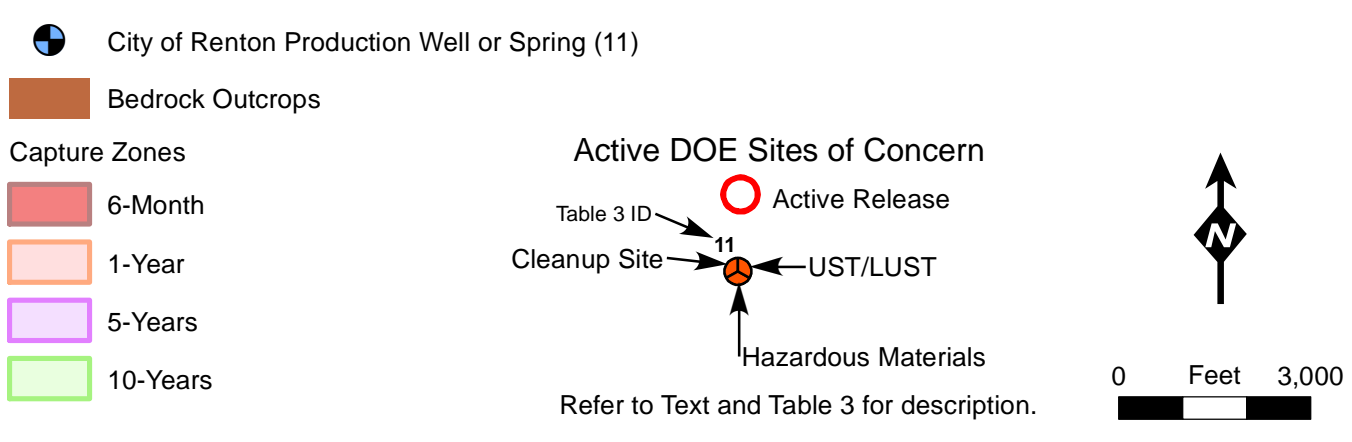
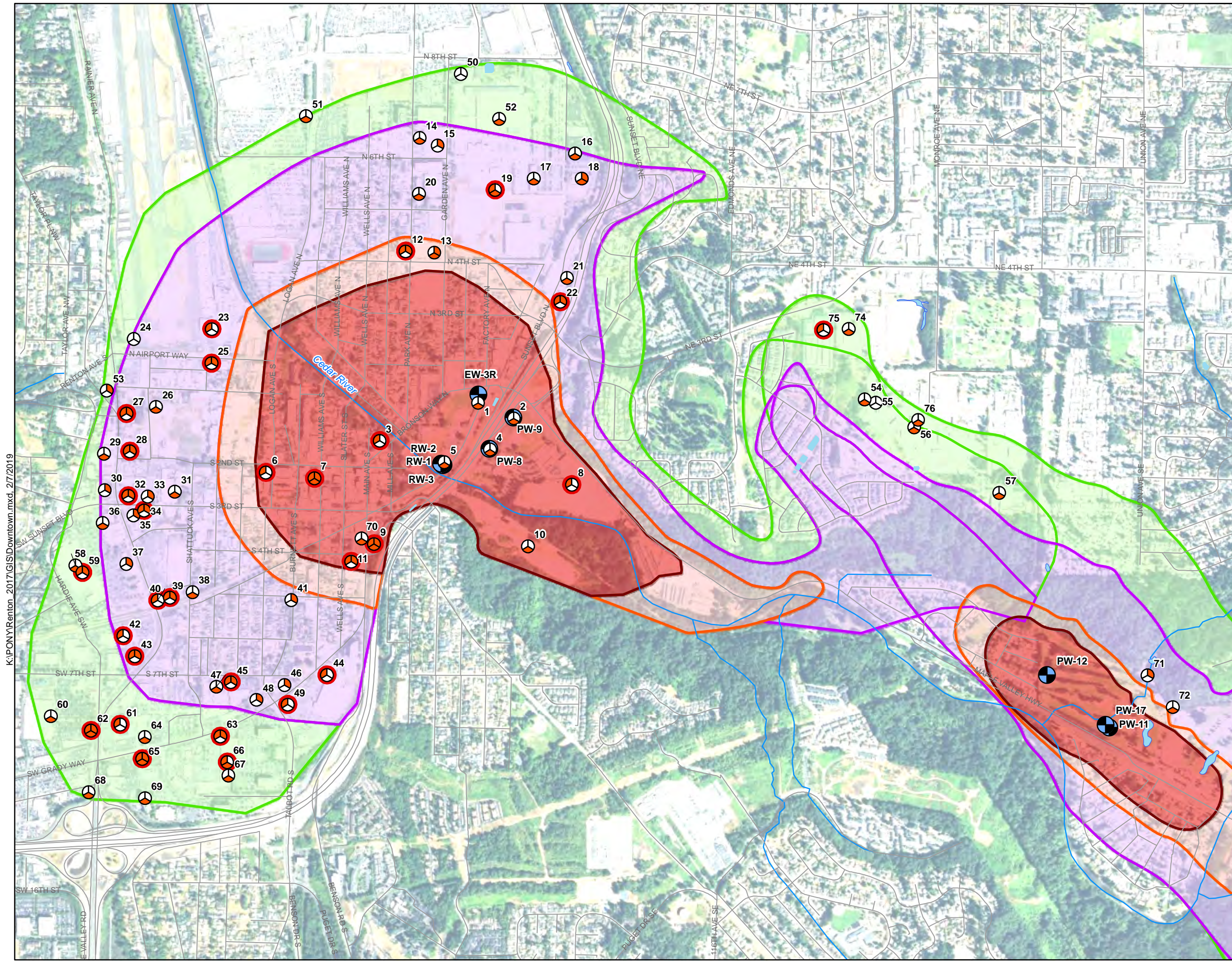

Figure 4
Potential Contaminant
Sources Within
City of Renton WHPAs

Figure 5
 Potential Contaminant
 Sources Within
 City of Renton
 Downtown WHPA



Active DOE Sites of Concern

- Table 3 ID → Active Release
- Cleanup Site → UST/LUST
- Hazardous Materials

Refer to Text and Table 3 for description.

- City of Renton Production Well
- Bedrock Outcrops
- Capture Zones
 - 6-Month
 - 1-Year
 - 5-Years
 - 10-Years

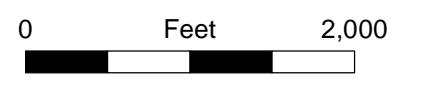

K:\PONY\Renton_2017\GIS\Downtown.mxd, 2/7/2019

APPENDIX A
FSID INTERACTION TYPE AND GROUNDWATER RISK IDENTIFICATION

Table A-1. Ecology Facility Site Database Interaction Types and Potential Hazard Posed to Groundwater

ACRONYM	INTERACTON TYPE	DEFINITION	WHPA Risk?	Hazardous Materials?	Cleanup Site?	UST/LUST?
AQARS	Air Qual Annual Reg Source	Facilities with actual or potential emissions that are less than thresholds identified for federal and state operating permit program. (These sources are smaller than operating permit program sources). See WAC 173-400-100				
AQGSR	Air Qual Gas Sta Reg	Gas stations and gasoline storage facilities. See Ch. 173-491 WAC.				
AQLA	Air Qual Local Authority Reg	Small sources governed only by local air authorities.				
AQOPS	Air Qual Oper Permit Source	Facilities with actual or potential emissions that are greater than 100 tons of (or 10 tons any one hazardous air pollutants or 25 tons per year of a combination of hazardous pollutants) fugitive air emissions per year. (These are generally large industrial facilities governed by the federal and state operating permit program.) See Ch. 173-401 WAC				
AQPR	Air Qual Periodic Reg	These businesses are the smallest sources required to report their emissions under the federal and state operating permit program. (These sources are generally smaller than registration sources). See WAC 173-400-102				
AQPS	Air Qual Permit Source	Facilities that as part of their process will emit air pollutants and are seeking construction permits for either a new source or changes to their existing facility. See WAC 173-400-110 or -114				
AQPSD	Air Qual PSD Source	All facilities that emit more than 250 tons per year of air pollutants, or 100 tons per year if the pollutants are within 28 listed categories.				
AQSYNMNR	Air Qual Synth Minor Source	Facilities that would be regulated under the operating permit program but have opted to keep their emission limits lower than the threshold for the program Their enforceable emission limits keep them out of the operating permit program. See WAC 173-400-03				
ENFORFNL	Enforcement Final	An Enforcement action (i.e. Penalty, Order, Notice) was finalized and issued to the respective party, indicating the enforcement action was taken. The start and end date listed in the database are both the date the action was issued to the responsible party.	Y			
NONENFNL	Non Enforcement Final	A Non-Enforcement action (i.e. permit, notice of construction, etc.) was finalized, issued to the respective party, indicating the non-enforcement action was taken.	Y			
TIER2	Emergency/Haz Chem Rpt TIER2	Businesses that store 10,000 pounds or more of a hazardous chemical or 500 pounds or less, depending on the chemical, of an extremely hazardous chemical on site at any one time must report annually. Reports are sent to the State Emergency Response Commission [represented by Ecology] Local Emergency Planning Committees, and local fire departments for emergency planning. [product, not waste]	Y	Y		
TRI	Toxics Release Inventory	Facilities in specific industries that manufacture, process or use more than the threshold amount of one or more of 600 listed toxic chemicals. Most threshold amounts are 10,000 or 25,000 pounds per year. Some chemicals have much lower thresholds.	Y	Y		
HWP	Hazardous Waste Planner	Under Chapter 173-307 WAC, facilities that report under Section 313 of the Emergency Planning/Community Right-To-Know Act (EPCRA), or that generate more than 2,640 pounds of hazardous waste per year, must prepare Pollution Prevention Plans.	Y	Y		
LSC	Local Source Control	The site has received a technical assistance visit from a Local Source Control Specialist.				
UW	Urban Waters	The site has received an inspection by an Ecology Urban Waters Inspector.				
RSVP	Revised Site Visit Program	The Hazardous Waste and Toxics Reduction Program engages in a variety of field work, site visits, and contacts with sites. While most compliance related activity is recorded into the EPA's RCRAInfo system, the other types of activities are recorded into the Revised Site Visit Program (RSVP).				
HWG	Hazardous Waste Generator	Facilities that generate any quantity of a dangerous waste. They may be classified as SQG, MQG, or LQG depending on hazardous waste generated for a given month.	Y	Y		
HWOTHER	Haz Waste Management Activity	Facilities that are required to have a RCRA Site ID# but who do not generate and/or manage hazardous waste (XQG generator status). This includes transporters, used oil recycler's, and dangerous waste fuel marketers and burners.	Y	Y		
HWTRNSFR	Haz Waste Transfer Facility	Transfer facility is a site, owned, leased or operated by a transporter of regulated hazardous waste shipments where any of the following occurs: 1) receives wastes from another transporter, 2) transfers wastes from one transport vehicle to another, 3) transfers waste from one container to another, and 4) stores waste within a vehicle or on property for 10 days or less. Examples of transfer facilities include a parking lot, warehouse, truck terminal, barge or steamship loading and unloading facility, or railroad spur loading or unloading facility.	Y	Y		
HWTSDF	Haz Treatment Storage Facility	Facilities that treat store or dispose hazardous waste.	Y	Y		

ACRONYM	INTERACTON TYPE	DEFINITION	WHPA Risk?	Hazardous Materials?	Cleanup Site?	UST/LUST?
401MIT	401CZM Mitigation Site	A 401Mit Site is in most cases associated with a 401Proj site. It is a compensatory mitigation site required as permit conditions for activities occurring at the 401Proj site. Mitigation sites are required for impacts to the state's water bodies and are to be protected in perpetuity. Examples of compensatory mitigation sites include; restoration, creation, enhancement, preservation, and mitigation bank sites.				
401PROJ	401CZM Project Site	A 401Proj Site is a location where a proposed activity has triggered an Ecology action based on its authority from Section 401 of the Clean Water Act and/or Coastal Zone Management Act. The activity may be pending or Ecology has taken some action (denied or approved a permit, conducted an enforcement action, etc.). Examples of projects include: commercial, residential, or industrial developments involving fill of wetlands; dredging and other in-water activities; bridge crossings; etc.				
401MITOLD	401CZM OLD Mitigation Site	A 401Mit Site is in most cases associated with a 401Proj site. It is a compensatory mitigation site required as permit conditions for activities occurring at the 401Proj site. Mitigation sites are required for impacts to the state's water bodies and are to be protected in perpetuity. Examples of compensatory mitigation sites include; restoration, creation, enhancement, preservation, and mitigation bank sites.				
401PROJOLD	401CZM OLD Project Site	A 401Proj Site is a location where a proposed activity has triggered an Ecology action based on its authority from Section 401 of the Clean Water Act and/or Coastal Zone Management Act. The activity may be pending or Ecology has taken some action (denied or approved a permit, conducted an enforcement action, etc.). Examples of projects Legacy Data -- include: commercial, residential, or industrial developments involving fill of wetlands; dredging and other in-water activities; bridge crossings; etc.				
CLASS1	Class 1 Facility	Applies to large, fixed shore-side facilities such as refineries, refueling terminals, and oil pipelines. This definition includes facilities that transfer to tank vessels and pipelines. Full definition can be found in Washington Administrative Code (WAC) 173-180-020.	Y			
CLASS2	Class 2 Facility	Applies to mobile equipment such as tank trucks, railcars, and portable tanks that transfer to any non-recreational vessel of any size. Full definition can be found in Washington Administrative Code (WAC) 173-180-020.	Y			
CLASS3	Class 3 Facility	Applies to small tank farms and terminals that transfer oil to non-recreational vessels that have a fuel capacity of 10,500 gallons or more. Full definition can be found in Washington Administrative Code (WAC) 173-180-020.	Y			
CLASS4	Class 4 Facility	Applies to marinas and other small fueling facilities that transfer oil to non-recreation vessels that have a fuel capacity of less than 10,500 gallons. Full definition can be found in Washington Administrative Code (WAC) 173-180-020.	Y			
CPLAN	Oil Facility Contingency Plan	Oil handling facilities that are required to file oil spill contingency plans. An oil handling facility can be classified as a structure, equipment, pipeline, or device located on or near navigable waters of the state that transfers oil in bulk to or from a tank vessel or pipeline and is used for producing, storing, handling, transferring, processing, or transporting oil in bulk.				
NERTS	Reported in NERTS	A facility that was reported in the Environmental Reports Tracking System	Y			
FCS	Federal (Superfund) Cleanup St	A federal cleanup site listed in CERCLIS where Ecology has been or is currently involved with the cleanup process or has knowledge of the site from another process.	Y		Y	
FUDS	Formerly Used Defense Site	The Department of Defense (DoD) is responsible for cleaning up properties that were formerly owned, leased possessed, or operated by DoD. Such properties are known as Formerly Used Defense Sites (FUDS). The Army is the executive agent for the program and the U.S. Army Corps of Engineers is the organization that manages and executes the program. Information about the origin and extent of contamination, land transfer issues, past and present property ownership, and program policies must be evaluated before DoD considers a property eligible for Defense Environment Restoration Account (DERA) funding under the FUDS program.	Y		Y	
INDPNDNT	Independent Cleanup	Any remedial action without department oversight or approval and not under an order or decree.	Y		Y	
IRAP	Independent Remedial Action Program	Ecology staff reviewed IRAP reports and provide written determination indicating whether the cleanup meets Model Toxics Control Act (MTCA) standards.	Y		Y	
LUST	LUST Facility	A leaking underground tank cleanup site being cleaned up with Ecology oversight or review.	Y		Y	Y
SCS	State Cleanup Site	A site is being cleaned up under state regulations. Regulations include Model Toxics Control Act or its predecessors.	Y		Y	

Table A-1. Ecology Facility Site Database Interaction Types and Potential Hazards Posed to Groundwater Renton WHPP Update

ACRONYM	INTERACTON TYPE	DEFINITION	WHPA Risk?	Hazardous Materials?	Cleanup Site?	UST/LUST?
SEDIMENT	Sediments	A sediment site is a location of interest at which sediment chemical and/or biological data has been obtained and evaluated for potential impacts to human health or the environment. Sediment sites may exist beneath or be associated with freshwater, marine and estuarine bodies of water. Sediment sites may or may not be linked to a known land-based facility.				
VOLCLNST	Voluntary Cleanup Sites	For a fee, Ecology staff will review an independent cleanup report(s) and provide a written decision about the adequacy of the cleanup actions taken and described in the report.	Y		Y	
SCI	Source Control Inspection	Source Control Inspection conducted by Ecology or other agency for TCP Cleanup Sites.				
UST	Underground Storage Tank	Any one or combination of tanks (including connecting underground pipes) that is used to contain regulated substances and has a tank volume of ten percent or more beneath the surface of the ground. This term does not include any of the exempt UST systems specified in WAC 173-360-110(2) or any piping connected thereto. See WAC 173-360	Y			Y
INDUSTRL	Industrial Sites	The Industrial Section focuses on three major industries of Washington State: Aluminum Smelters, Oil refineries and Pulp and Paper Mills. The Section's staff is trained to handle the complexities of these industries and is responsible for environmental permitting, site inspections, and compliance issues. They regulate air, water, hazardous waste, and cleanup management activities at pulp and paper mills and aluminum smelters. They also regulate water, hazardous waste, and cleanup management activities at state oil refineries.	Y			
BIOSOLIDS	BIOSOLIDS	Biosolids	Y			
COMPOST	Composting	Compost facilities turn organic wastes into compost under controlled conditions without attracting pests or creating human or environmental health problems.	Y			
LANDAPP	Land Application	An area of land, under the same ownership or operator, where solid waste that has beneficial use for its agronomic or soil-amending properties is applied under controlled amounts and conditions.	Y			
LANDFILL	Landfill	A disposal facility or part of a facility at which solid waste is placed in or on land and which is not a land treatment facility.	Y			
MRW	Moderate Risk Waste	A solid waste handling facility that is used to collect, treat, recycle, exchange, store, consolidate and/or transfer moderate risk waste (MRW). MRW is limited to conditionally exempt small quantity generator (CESQG) waste and household hazardous waste (HHW).	Y			
RECOVERY	Energy Recovery	Energy recovery facilities that recover energy in a useable form from the burning (incineration) of solid waste. These include energy-recovery facilities that burn municipal solid waste and paper manufactures who burn wood waste at a rate of more than twelve tons of solid waste per day.	Y			
RECYCLE	Recycling	Recycling facilities are those that transform or remanufacture waste materials into usable or marketable materials for use other than landfill disposal or incineration. Requirements do not include the collection, compacting, repackaging and sorting for the purpose of transport.	Y			
STRHAND	Storage & Handling	Various types of facilities that handle solid waste on an interim basis. These include piles of solid waste, surface impoundments holding liquids, drop boxes where solid waste is collected for future transportation, areas storing over 800 tires, and transfer stations where solid waste is collected, compacted, sorted and loaded for transport to a recycling facility or final disposal at a landfill or incineration.	Y			
WQDAIRY	Dairy	Any farm licensed to produce milk under chapter 15.36 RCW. This definition is further restricted to include only those facilities that are producing bovine milk (as opposed to goat milk), and excludes other dairy related operations such as replacement heifer rearing farms. It should be noted that some dairies have more than one milking parlor and therefore have more than one license.	Y			
APALGAEGP	AP Aquatic Plant and Algae Management GP	General permit to regulate application of herbicides and other products used in lakes to treat plants or algae in order to protect state waters.	Y			
APFISHIP	AP Fish Management IP	Individual permit issued to WA State Fish and Wildlife (WFDW) that regulates the discharge of 2 fish eradication chemicals (rotenone and antimycin A used to control undesirable fish species) in order to protect waters of the state.	Y			
APFISHRMGP	AP Fisheries Resource Management GP	Fisheries Resource Management Permit issued to WA WDFW Rotenone permit	Y			
APINVAQG	AP Aquatic Invasive Species Ma	General permit issued to regulate the application of chemicals (used to control non-native invasive aquatic animals and non-native invasive marine algae) in order to protect state waters.	Y			
APMOSQGP	AP Aquatic Mosquito Control GP	General permit issued to regulate mosquito control districts and government entities that apply specified control chemicals (used to control mosquitoes and mosquito larvae) in order to protect state waters.	Y			

Table A-1. Ecology Facility Site Database Interaction Types and Potential Hazards Posed to Groundwater Renton WHPP Update

ACRONYM	INTERACTON TYPE	DEFINITION	WHPA Risk?	Hazardous Materials?	Cleanup Site?	UST/LUST?
APMOTHIP	AP Invasive Moth Control IP	Individual permit issued to WA State Dept of Agriculture to regulate insecticides (used to control invasive moths) applied to vegetation within and overhanging surface waters in order to protect state waters.	Y			
APNXWEEG	AP Aquatic Noxious Weed Manage	The general permit covers the indirect discharge of herbicides, adjuvants, and marker dyes into estuaries, marine areas, wetlands, along lake shorelines, rivers, streams, and other wet areas to manage Spartina and freshwater noxious weeds in Washington. An indirect discharge occurs when there may be incidental overspray or dripping of a chemical from the treated plants into waters of the state.	Y			
APOYSTERIP	AP Oyster Growers IP	Individual permit issued to Willapa Bay/Grays Harbor Oyster Growers and to Farm and Forest Helicopter Service Inc. to regulate application of carbaryl (used to control burrowing shrimp) to state waters.	Y			
APWEEDGP	AP Irrigation System Aquatic Weed Control GP	General permit issued to regulate applicators of herbicides to control aquatic weeds in irrigation water conveyance systems	Y			
BOATGP	Boatyard GP	General permit issued to boatyards to regulate discharges of pollutants to state waters from boatyard construction, maintenance and repair activities	Y			
BRIDGEWASHGP	Bridge Washing GP	General Permit for bridge washing DOT counties cities etc				
CAFOGP	CAFO GP	General permit issued to regulate operators of concentrated animal feeding operations that discharge to state waters.	Y			
CAFOIP	Cafo NPDES IP	Individual NPDES permit issued to regulate operators of concentrated animal feeding operations that discharge to state waters.	Y			
CONSTSWGP	Construction SW GP	General permit issued to owner/operators of construction projects that disturb 1 or more acres of land through clearing, grading, excavating, or stockpiling of fill material that discharge stormwater to state waters.				
DAIRY	Dairy Unpermitted	Unpermitted Dairy (Facility Site Place Holder)	Y			
FISHGP	Upland Fish Hatchery GP	General permit issued to operators of upland fin-fish hatching and rearing operations to regulate discharges to state waters				
FISHNETPENS	Fish Net Pens	In water structures that raise or hold fish. This separates these facilities from upland hatchery/fish rearing structures. They will all have NPDES permit. Some are in fresh water and some marine, but all will be located in a waterbody, not on land.				
FRUITGP	Fruit Packer GP	General permit issued to fruit packers to regulate discharges of process wastewater and stormwater to state waters.	Y			
IND2GROUNDSWDP	Industrial to ground SWDP IP	Industrial to ground SWDP IP	Y			
IND2POTWPRIVSWDP	Industrial to POTW/Private SWD	Industrial state waste discharge permit for facility that discharges pretreated wastewater to a public or privately owned treatment works (POTW).	Y			
INDNPDESIP	Industrial NPDES IP	Individual NPDES and State permits issued to industries to regulate discharges of process wastewater to state waters.	Y			
INDSWGP	Industrial SW GP	General permit issued to industries to regulate the discharge of contaminated stormwater to state waters.				
MARIJUANA	Marijuana Growers	This interaction is used for marijuana growers that fill out the checklist Ecology provides when they call and ask whether they will need a permit.				
MS4P1GP	Municipal SW Phase I GP	General permit issued to municipalities with populations greater than 100,000 to regulate stormwater discharges from municipal stormwater collections systems to state waters.				
MS4P2EASTGP	Municipal SW Phase II Eastern WA GP	General permit issued to all operators of regulated small municipal stormwater collection systems to regulate stormwater discharges to state waters in eastern WA.				
MS4P2WESTGP	Municipal SW Phase II Western WA GP	General permit issued to operators of small municipal stormwater collection systems to regulate stormwater discharges to state waters in western WA.				
MUNI2GROUNDSWDP	Municipal to ground SWDP IP	Municipal to ground SWDP IP	Y			
MUNINPDESIP	Municipal NPDES IP	Individual NPDES and State permits issued to municipalities and other public entities to regulate discharges of treated domestic wastewater to state waters.	Y			
NONPOINT	NONPOINT	A Facility or Site that is discharging polluted runoff from urban, agriculture, forestry or other practices and does not have a water quality permit.	Y			
RECLAIMSWDP	Reclaimed Water IP	Individual permit issued to a generator of reclaimed water that regulates the location, the rate, the quality, and the purpose of use of the reclaimed water.	Y			
SANDGP	Sand and Gravel GP	General permit issued to sand and gravel mining operators to regulate the discharge of pollutants to state waters.	Y			
VESSELDECONSGP	Vessel Deconstruction GP	Vessel Deconstruction GP	Y			
WATERCOLLECTGP	Tributary Wastewater Collection System GP	General permit issued to operators of tributary domestic wastewater collection systems not regulated under an individual permit.	Y			
WATERTREATGP	Water Treatment Plant GP	General permit issued to water treatment plants to regulate the discharge of backwash (generated during potable water production) to state waters.	Y			
WINEGP	Winery GP	General permit issued to regulate wineries that discharge process wastewater to state waters.	Y			
WSDOTMSWGP	WSDOT Municipal SW GP	General permit issues to the WA State Department of Transportation to regulate its discharge of stormwater (runoff from state highways, rest areas, park and ride lots, ferry terminals, and maintenance facilities) to state waters.				

Table A-1. Ecology Facility Site Database Interaction Types and Potential Hazards Posed to Groundwater Renton WHPP Update

ACRONYM	INTERACTON TYPE	DEFINITION	WHPA Risk?	Hazardous Materials?	Cleanup Site?	UST/LUST?
DAM	Dam Site	Under state law, the Department of Ecology is responsible for regulating dams that capture and store at least 10 acre-feet of water or watery materials such as mine tailings, sewage and manure waste. Ecology's Dam Safety Office currently oversees about 870 dams across the state through plan reviews and construction inspections of new dams as well as conducting inspections of existing dams to assure proper operation and maintenance.				

Note: Professional judgement was applied in creating this list of potential groundwater hazards. It assumes that groundwater and surface water are in direct continuity, and therefore applications of pesticides or herbicides to surface waters could impact groundwater. General stormwater discharge permits were not included as potential hazards since stormwater from all sites within WHPAs potentially drain to state waters, and therefore stormwater pollution risks are not limited to only permitted sites .

APPENDIX B
WHPA NO FURTHER ACTION SITE TABLE

Table B-1. Cleanup Sites With No Further Action Determinations Within Renton WHPAs

FSID	Cleanup Site Id	Facility Name	Facility Address	Hazardous Materials	LUST	Environmental Covenant
2066	5054	Renton School Dist 403	1220 N 4TH ST	Y	Y	
2068	93	JH BAXTER & CO INC	5015 LAKE WASHINGTON BLVD N	Y		Y
2169	1155	RENTON TRANSFER STATION	S OF NE 4TH ST			
2193	1240	WASHINGTON NATURAL GAS RENTON	319 S 3RD ST			
2207	5067	Texaco Station 120645	1408 BRONSON WAY N	Y	Y	
2315	1992	PERFORMANCE APEX AUTO SHOP	410 SUNSET BLVD N	Y		
2367	2059	JA MERICA MOTORS	4111 NE SUNSET BLVD			
2475	3049	GARDEN PLAZA	PARK AVE N & N 6TH ST			Y
2514	5130	UNOCAL SERVICE STATION 6321	17500 140TH AVE SE	Y	Y	
2532	2419	RENTON SCHOOL DIST 403 WAREHOUSE	235 AIRPORT WAY S	Y		
2559	5150	ARCO STATION 4400	3123 NW SUNSET BLVD	Y	Y	
2570	5158	US WEST RENTON ADMIN	300 SW 7TH ST		Y	
3538	5206	KENNYDALE FUEL	1616 NE 30TH ST	Y	Y	
5418	177	DUKES TRANSMISSION & USED CARS	251 RAINIER AVE N			
5448	233	ConocoPhillips 2705509	3002 SUNSET BLVD NE	Y	Y	
15012	12112	Potoshnik Property	3401 3403 BURNETT AVE N			
15792	12559	COMMERCIAL PROPERTY LAKE WASHINGTON BLVD N	1100 LAKE WASHINGTON BLVD N		Y	
22298	2832	Renton Honda Shop	858 LIND AVE SW		Y	
333151	3978	PROPOSED RENTON MIXED USE REDEV PROJECT	559 601 625 RAINIER AVE N			
706771	444	Shannons Village	1630 DUVALL AVE NE			
1771950	5264	77 Burnett Ave South	77 BURNETT AVE S		Y	
1932257	2156	Le Pham Property	19016 116TH AVE SE			
3193787	2523	Hanson Property	2225 JONES AVE NE			
3441394	7539	Jiffy Lube Store 2758	3933 NE 4TH ST	Y	Y	
3834333	5327	SUNSET CHEVRON	150 SUNSET BLVD SW	Y	Y	
4474679	2708	Car Wash Enterprises CWE Renton	77 RAINIER AVE S	Y	Y	
4487258	2583	Vino Ristorante Italiano	212 S 3RD ST			
5101053	1514	Economy Auto Repair former	4815 NE 4TH ST			
5168785	5353	Aqua Barn	15227 RENTON MAPLE VALLEY RD		Y	

Table B-1. Cleanup Sites With No Further Action Determinations Within Renton WHPAs
Renton WHPP Update

Table B-1. Cleanup Sites With No Further Action Determinations Within Renton WHPAs

FSID	Cleanup Site Id	Facility Name	Facility Address	Hazardous Materials	LUST	Environmental Covenant
5494605	1025	OLYMPIC PIPE LINE CO MAPLEWOOD	3524 SE 5TH ST			
5796263	1093	Kens Dry Cleaners	17620 140TH AVE SE SUITE C8	Y		
6417829	7701	Puget Sound Helicopter Inc	300 AIRPORT WAY S	Y	Y	
7567537	844	Fogarrd Baker	5325 NE 4TH ST			
8119234	7773	MCCANN ENTERPRISES INC	13029 136TH AVE SE		Y	
8980557	4503	Lakeshore Landing Residential Site	1201 N 10TH PL			
9625997	424	SUNSET VIEW APARTMENTS	2101 SW SUNSET BLVD			
16258354	8124	RENTON BP	300 320 RAINIER AVE S	Y	Y	
16674799	7231	Chevron USA Inc SS 94522	4044 NE SUNSET BLVD	Y	Y	
21164679	5675	Arco 5238	175 RAINIER AVE S	Y	Y	
26515148	5785	RENTON SHOPPING CENTER	351 HARDIE AVE SW		Y	Y
27124698	4111	Friedels Svc Inc	345 FACTORY PL N	Y		
27383166	5801	COOKS CHEVRON MART II	201 S 3RD ST	Y	Y	
28815815	638	PDQ Cleaners	3807 NE 4TH	Y		
32528923	5873	GULL 229	2904 MAPLE VALLEY HWY	Y	Y	
32954817	4262	KING CNTY DPW RENTON FACILITY	155 MONROE AVE NE	Y		
34987922	8821	TEXACO STATION 632320180	14210 SE PETROVITSKY	Y	Y	
36726432	8901	KING COUNTY PUBLIC WORKS ROADS DIV	155 MONROE AVE NE BLDG A		Y	
36993943	11786	Arco 6026	17200 140TH AVE SE	Y	Y	
46734965	6142	7 ELEVEN 233216921	1520 DUVALL AVE NE		Y	
47138342	9351	Arco 5902	710 S GRADY WAY	Y	Y	
47783192	9385	Circle K Store 2701602	20727 108TH AVE SE	Y	Y	
47917271	6155	RENTON NORTHWEST LLC	4105 NE 4TH ST	Y	Y	
48271835	6160	Shell Station 120646	1410 N 30TH ST	Y	Y	
51753478	6202	CHEVRON 97111	19044 108TH AVE SE	Y	Y	
54463839	12913	Bryant Motors	1300 BRONSON WAY N	Y		
55297998	4744	RENTON SCHOOL DISTRICT	410 PARK AVE			
61614156	6378	GULL 205	3800 NE 4TH	Y	Y	
62238722	1197	WALTS SERVICE CENTER	546 BURNETT AVE N			
63659812	9975	Cascade Lincoln Mercury	201 S 7TH ST	Y	Y	

Table B-1. Cleanup Sites With No Further Action Determinations Within Renton WHPAs
Renton WHPP Update



Table B-1. Cleanup Sites With No Further Action Determinations Within Renton WHPAs

FSID	Cleanup Site Id	Facility Name	Facility Address	Hazardous Materials	LUST	Environmental Covenant
64293294	9996	MAPLEWOOD MAINTENANCE SHOP	4000 MAPLE VALLEY HWY		Y	
64969378	4226	T & S AUTOMOTIVE SALES	515 RAINIER AVE S			
68451915	2647	Fairwood Cleaners Inc	17240 140TH AVE SE	Y		
71471562	6545	CHARLEYS AUTOMOTIVE	207 MAIN ST S		Y	
72553632	10282	Arco 5491	1537 DUVALL AVE NE	Y	Y	
72727118	10292	NW ENTERPRIZES CORPORATION	3123 NE 4TH		Y	
72762979	10295	Goodyear Auto Service Center 8821	207 S 3RD ST	Y	Y	
73233112	10311	Shell Station 121227	4102 NE 4TH ST	Y	Y	
74465899	6610	Kennydale Chevron	1419 N 30TH ST	Y	Y	
78566837	2963	LES SCHWAB TIRES RENTON	710 RAINIER AVE S			
79696523	6686	JC MART	2801 NE SUNSET BLVD		Y	
81135179	4322	ORCHARD PLAZA SHOPPING CTR DRY CLEANERS	20910 108TH AVE SE			
82472985	2892	North American Refractories	1500 HOUSER WAY S	Y		
82651824	1130	BNSF Shattuck Street Derailment	SHATTUCK & HOUSER STS			
84748394	4625	Lithia Lot A Car of Renton	700 S GRADY WAY			
85831936	4325	Plat of Shady Estates	S 197TH PL & TALBOT RD S			
85953633	10844	PACCAR MIS	480 HOUSER WAY N	Y	Y	
88647696	6816	SUNSET RAINIER RENTON WALGREENS	299 RAINIER AVE S	Y	Y	
97278611	11276	SHORT STOP MINI MART	4615 NE 4TH ST	Y	Y	
97722694	1936	RENTON HIGHLANDS	2880 NE 3RD ST			

APPENDIX C
ENVIRONMENTAL SITES INFORMATION

KING COUNTY

SITE ID:	Renton Highlands Landfill	Cleanup Site ID: 212	FS ID: 2128
-----------------	----------------------------------	----------------------	-------------

Alternate Name(s): Highlands Landfill, RENTON HIGHLANDS LANDFILL

LOCATION:	WRIA: 8	Lat/Long: 47.486 -122.181	View Vicinity Map
Address:	NE 3RD ST & NE 4TH ST RENTON 98056	Township: 23N Range: 5E Section: 16	Legislative District: 11 Congressional District: 9

STATUS:	Awaiting Cleanup	Rank:	View Site Web Page	View Site Documents
	Responsible Unit: Northwest	Site Manager: Northwest Region	Statute: MTCA	
	Is Brownfield?	Has Environmental Covenant?	Is PSI Site?	
	NFA Received?	NFA Date:	NFA Reason:	

ASSOCIATED CLEANUP UNIT(s)

cuID	Cleanup Unit Name	Unit Type	Process Type	Unit Status	Size (Acres)	ERTS ID
1001	Renton Highlands Landfill	Upland	No Process	Awaiting Cleanup		

SITE ACTIVITIES:

Applies to:	Related ID (Unit-LUST-VCP)	Activity Display Name	Status	Start Date	End Date	Legal Mechanism	Performed By	Project Manager
CleanupSite		Site Discovery/Release Report Received	Completed	3/1/1988	3/1/1988			Northwest Region

AFFECTED MEDIA & CONTAMINANTS:

Media:

Contaminant:	Ground Water	Surface Water	Soil	Sediment	Air	Bedrock
Conventional Contaminants, Inorganic			S			
Conventional Contaminants, Organic			S			

Key:

B - Below Cleanup Level
C - Confirmed Above Cleanup Level
S - Suspected
R - Remediated
RA - Remediated-Above
RB - Remediated-Below

CleanupSiteDetails2014

KING COUNTY

SITE ID:	Scott Drycleaners	Cleanup Site ID: 644	FS ID: 62912812
-----------------	--------------------------	----------------------	-----------------

Alternate Name(s): Scott Drycleaners

LOCATION:	WRIA: 9	Lat/Long: 47.476 -122.215	View Vicinity Map
Address: 201 S 4TH PL RENTON 98055	Township 23N	Range 5E	Section 18
			Legislative District: 37 Congressional District: 9

STATUS:	Cleanup Started	Rank:	View Site Web Page	View Site Documents
Responsible Unit: Northwest	Site Manager: Northwest Region	Statute: MTCA		
Is Brownfield?	Has Environmental Covenant?	Is PSI Site?		
NFA Received?	NFA Date:	NFA Reason:		

ASSOCIATED CLEANUP UNIT(s)

culID	Cleanup Unit Name	Unit Type	Process Type	Unit Status	Size (Acres)	ERTS ID
4115	Scott Drycleaners	Upland	Independent Action	Cleanup Started		515631 / 634327

SITE ACTIVITIES:

Applies to:	Related ID (Unit-LUST-VCP)	Activity Display Name	Status	Start Date	End Date	Legal Mechanism	Performed By	Project Manager
CleanupSite		Site Discovery/Release Report Received	Completed	12/13/2000	12/13/2000			Colburn, Gail
CleanupSite		Initial Investigation / Federal Preliminary Assessment	Completed	2/1/2001	2/1/2001		Local Government	County Health-NW
CleanupSite		Early Notice Letter(s)	Completed	10/22/2001	10/22/2001			Bremer, Steve
VcpProject	NW1145	VCP Opinion on Cleanup Action	Completed	8/13/2003				Maurer, Christopher

AFFECTED MEDIA & CONTAMINANTS:

Media:

Contaminant:	Ground Water	Surface Water	Soil	Sediment	Air	Bedrock
Halogenated Organics	C		C			

Key:

B - Below Cleanup Level
 C - Confirmed Above Cleanup Level
 S - Suspected
 R - Remediated
 RA - Remediated-Above
 RB - Remediated-Below

CleanupSiteDetails2014

KING COUNTY

SITE ID: PACIFIC CAR & FOUNDRY CO Cleanup Site ID: 788 FS ID: 2065

Alternate Name(s): ACTIVE USA INC, DALLAS & MAVIS FORWARDING TRUCK DEC, PACCAR DEFENSE SYSTEMS, PACCAR INC RENTON SITE, PACIFIC CAR & FOUNDRY CO, PACIFIC CAR & FOUNDRY CO., PACIFIC CAR & FOUNDRY COMPANY, PACIFIC CAR AND FOUNDRY COMPANY

LOCATION: WRIA: 8 Lat/Long: 47.491 -122.198 [View Vicinity Map](#)

Address: 1400 N 4TH ST Township Range Section Legislative District: 37

RENTON 98057 Congressional District: 9

STATUS: **Construction Complete-Performance Monitoring** Rank: 0 [View Site Web Page](#) [View Site Documents](#)

Responsible Unit: Northwest Site Manager: Timm, Ron Statute: MTCA

Is Brownfield? Has Environmental Covenant? Yes Is PSI Site?

NFA Received? NFA Date: NFA Reason:

ASSOCIATED CLEANUP UNIT(s)

culID	Cleanup Unit Name	Unit Type	Process Type	Unit Status	Size (Acres)	ERTS ID
955	PACIFIC CAR AND FOUNDRY COMPANY	Upland	Federal-supervised or conducted	Cleanup Complete-Active O&M/Monitoring ongoing		

SITE ACTIVITIES:

Applies to:	Related ID (Unit-LUST-VCP)	Activity Display Name	Status	Start Date	End Date	Legal Mechanism	Performed By	Project Manager
CleanupSite		Site Hazard Assessment/Federal Site Inspection	Completed	9/10/1990	9/10/1990		Ecology	South, David
CleanupSite		Hazardous Sites Listing/NPL	Completed	9/10/1991	9/10/1991			South, David
CleanupSite ActivityType		Periodic Review	Planned	3/1/2019				Freeman, Eugene
CleanupSite ActivityType		Periodic Review	Completed	10/1/2009	11/23/2009			Hickey, Joe
CleanupSite ActivityType		Periodic Review	Completed	3/1/2014	7/1/2014			Freeman, Eugene
CleanupSite MilestoneType		O & M	In Process	11/8/1997	3/31/2012			South, David
Milestone		Remedial Investigation and/or Feasibility Study	Completed	7/1/1988	8/30/1991			South, David
Milestone		Cleanup Action Plan	Completed	6/15/1990	9/15/1991			South, David
Milestone		Cleanup - Construction	Completed	9/15/1991	11/8/1997			South, David

AFFECTED MEDIA & CONTAMINANTS:

Media:

Contaminant:	Ground Water	Surface Water	Soil	Sediment	Air	Bedrock
Conventional Contaminants, Inorganic			C			

Key:

B - Below Cleanup Level
C - Confirmed Above Cleanup Level
S - Suspected

R - Remediated
RA - Remediated-Above
RB - Remediated-Below

Halogenated Organics	C	C			
Metals - Other		C			
Metals Priority Pollutants	C	C			
Non-Halogenated Solvents		C			
Petroleum Products-Unspecified		C			
Phenolic Compounds		C			
Polychlorinated biPhenyls (PCB)		C			
Polycyclic Aromatic Hydrocarbons		C			

CleanupSiteDetails2014

KING COUNTY

SITE ID:	Sky Harbor Aviation	Cleanup Site ID: 1170	FS ID: 63051958
-----------------	----------------------------	-----------------------	-----------------

Alternate Name(s): RENTON MUNICIPAL AIRPORT, SKY HARBOR AVIATION

LOCATION:	WRIA: 8	Lat/Long: 47.486 -122.214	View Vicinity Map
Address:	300 AIRPORT WAY S RENTON 98055	Township: 23N Range: 5E Section: 18	Legislative District: 37 Congressional District: 9

STATUS:	Awaiting Cleanup	Rank: 5	View Site Web Page	View Site Documents
	Responsible Unit: Northwest	Site Manager: Northwest Region	Statute: MTCA	
	Is Brownfield?	Has Environmental Covenant?	Is PSI Site?	
	NFA Received?	NFA Date:	NFA Reason:	

ASSOCIATED CLEANUP UNIT(s)

cuID	Cleanup Unit Name	Unit Type	Process Type	Unit Status	Size (Acres)	ERTS ID
4121	Sky Harbor Aviation	Upland	No Process	Awaiting Cleanup		502544

SITE ACTIVITIES:

Applies to:	Related ID (Unit-LUST-VCP)	Activity Display Name	Status	Start Date	End Date	Legal Mechanism	Performed By	Project Manager
CleanupSite		Site Discovery/Release Report Received	Completed	3/31/1999	3/31/1999			Northwest Region
CleanupSite		Initial Investigation / Federal Preliminary Assessment	Completed	3/31/1999	3/31/1999		Ecology	Northwest Region
CleanupSite		Early Notice Letter(s)	Completed	9/7/1999	9/7/1999			Northwest Region
CleanupSite		Site Hazard Assessment/Federal Site Inspection	Completed	3/13/2002	8/2/2002		Local Government	County Health-NW
CleanupSite		Hazardous Sites Listing/NPL	Completed	8/2/2002	8/2/2002			Northwest Region

AFFECTED MEDIA & CONTAMINANTS:

Media:

Contaminant:	Ground Water	Surface Water	Soil	Sediment	Air	Bedrock
Non-Halogenated Solvents	S		C			
Petroleum Products-Unspecified	S		C			

Key:

B - Below Cleanup Level
C - Confirmed Above Cleanup Level
S - Suspected

R - Remediated
RA - Remediated-Above
RB - Remediated-Below

CleanupSiteDetails2014

KING COUNTY

SITE ID:	Stoneway Concrete Renton	Cleanup Site ID: 2121	FS ID: 62244377
-----------------	---------------------------------	-----------------------	-----------------

Alternate Name(s): RENTON PLANT, Stoneway Concrete Renton

LOCATION:	WRIA: 8	Lat/Long: 47.481 -122.194	View Vicinity Map
Address:	1915 SE MAPLE VALLEY HWY RENTON 98055	Township: 23N Range: 5E Section: 17	Legislative District: 11 Congressional District: 9

STATUS:	Cleanup Started	Rank:	View Site Web Page	View Site Documents
	Responsible Unit: Northwest	Site Manager: Warfel, Michael	Statute: MTCA	
	Is Brownfield?	Has Environmental Covenant?	Is PSI Site?	
	NFA Received?	NFA Date:	NFA Reason:	

ASSOCIATED CLEANUP UNIT(s)

cuID	Cleanup Unit Name	Unit Type	Process Type	Unit Status	Size (Acres)	ERTS ID
4094	Renton Plant	Upland	Voluntary Cleanup Program	Cleanup Started		

SITE ACTIVITIES:

Applies to:	Related ID (Unit-LUST-VCP)	Activity Display Name	Status	Start Date	End Date	Legal Mechanism	Performed By	Project Manager
VcpProject	NW1702	VCP Receipt of Plan or Report	Completed	8/11/2015	8/11/2015			Bardy, Louise
VcpProject	NW1702	VCP Receipt of Plan or Report	Completed	4/24/2017	4/24/2017			Fernandez, Sonia
VcpProject	NW1702	VCP Opinion on Site Cleanup Plan	Completed	4/24/2017	8/31/2017			Warfel, Michael
VcpProject	NW1702	VCP Status Request	Completed	6/14/2015	8/11/2015			Bardy, Louise
VcpProject	NW1702	VCP Opinion on Interim Action	Completed	11/29/2006				Headquarters
VcpProject	NW1702	VCP Opinion on Cleanup Action Plan	Completed	3/9/2009	4/30/2009			Goldstein, Libby

AFFECTED MEDIA & CONTAMINANTS:

Media:

Contaminant:	Ground Water	Surface Water	Soil	Sediment	Air	Bedrock
Petroleum Products-Unspecified			C			

Key:

B - Below Cleanup Level
C - Confirmed Above Cleanup Level
S - Suspected

R - Remediated
RA - Remediated-Above
RB - Remediated-Below

CleanupSiteDetails2014

KING COUNTY

SITE ID: **PSE Grady Way Renton Complex Parcel 2** Cleanup Site ID: 2743 FS ID: 21349929

Alternate Name(s): PSE GRADY WAY RENTON COMPLEX PARCEL 2, TALBOT STORAGE YARD

LOCATION: WRIA: 9 Lat/Long: 47.473 -122.208 [View Vicinity Map](#)

Address: 915 S GRADY WAY RENTON 98055 Township 23N Range 5E Section 19 Legislative District: 11 Congressional District: 9

STATUS: **Cleanup Started** Rank: [View Site Web Page](#) [View Site Documents](#)

Responsible Unit: Northwest Site Manager: Northwest Region Statute: MTCA
 Is Brownfield? Has Environmental Covenant? Yes Is PSI Site?
 NFA Received? NFA Date: NFA Reason:

ASSOCIATED CLEANUP UNIT(s)

culID	Cleanup Unit Name	Unit Type	Process Type	Unit Status	Size (Acres)	ERTS ID
3481	PSE Grady Way Renton Complex Parcel 2	Upland	Independent Action	Cleanup Started		

SITE ACTIVITIES:

Applies to:	Related ID (Unit-LUST-VCP)	Activity Display Name	Status	Start Date	End Date	Legal Mechanism	Performed By	Project Manager
CleanupSite		Site Discovery/Release Report Received	Completed	1/20/2000	1/20/2000			Northwest Region
CleanupSite		Initial Investigation / Federal Preliminary Assessment	Completed					Northwest Region
CleanupSite		Site Hazard Assessment/Federal Site Inspection	Canceled	4/7/2015	9/25/2015		Ecology w/ Contractor	Musa, Donna
VcpProject	NW0429	VCP Opinion on Cleanup Action	Completed	1/20/2000	2/3/2000			Madakor, Nnamdi

AFFECTED MEDIA & CONTAMINANTS:

Media:

Contaminant:	Ground Water	Surface Water	Soil	Sediment	Air	Bedrock
Metals Priority Pollutants	C		R			
Petroleum Products-Unspecified	C		R			
Polychlorinated biPhenyls (PCB)	S		R			

Key:

B - Below Cleanup Level
 C - Confirmed Above Cleanup Level
 S - Suspected
 R - Remediated
 RA - Remediated-Above
 RB - Remediated-Below

CleanupSiteDetails2014

KING COUNTY

SITE ID: **PSE Grady Way Renton Complex Parcel 3** Cleanup Site ID: 2893 FS ID: 86541135

Alternate Name(s): PSE GRADY WAY RENTON COMPLEX PARCEL 3, TALBOT STORAGE YARD

LOCATION: WRIA: 9 Lat/Long: 47.471 -122.207 [View Vicinity Map](#)

Address: 915 S GRADY WAY RENTON 98055 Township 23N Range 5E Section 19 Legislative District: 11 Congressional District: 9

STATUS: **Cleanup Started** Rank: [View Site Web Page](#) [View Site Documents](#)

Responsible Unit: Northwest Site Manager: Northwest Region Statute: MTCA

Is Brownfield? Has Environmental Covenant? Is PSI Site?

NFA Received? NFA Date: NFA Reason:

ASSOCIATED CLEANUP UNIT(s)

culID	Cleanup Unit Name	Unit Type	Process Type	Unit Status	Size (Acres)	ERTS ID
4507	PSE GRADY WAY RENTON COMPLEX PARCEL 3	Upland	Independent Action	Cleanup Started		

SITE ACTIVITIES:

Applies to:	Related ID (Unit-LUST-VCP)	Activity Display Name	Status	Start Date	End Date	Legal Mechanism	Performed By	Project Manager
CleanupSite		Site Discovery/Release Report Received	Completed	1/20/2000	1/20/2000			Northwest Region
CleanupSite		Site Hazard Assessment/Federal Site Inspection	Canceled	4/7/2015	9/25/2015		Ecology w/ Contractor	Musa, Donna
VcpProject	NW0430	VCP Opinion on Cleanup Action	Completed	1/20/2000	12/31/2002			Madakor, Nnamdi

AFFECTED MEDIA & CONTAMINANTS:

Media:

Contaminant:	Ground Water	Surface Water	Soil	Sediment	Air	Bedrock
Metals Priority Pollutants	C		R			
Petroleum Products-Unspecified	C		R			
Polychlorinated biPhenyls (PCB)	S		R			

Key:

B - Below Cleanup Level
C - Confirmed Above Cleanup Level
S - Suspected

R - Remediated
RA - Remediated-Above
RB - Remediated-Below

CleanupSiteDetails2014

KING COUNTY

SITE ID:	Renton Village Cleaners	Cleanup Site ID: 3328	FS ID: 4484368
-----------------	--------------------------------	-----------------------	----------------

Alternate Name(s): Renton Village, Renton Village Cleaners, RENTON VILLAGE DRY CLEANERS

LOCATION:	WRIA: 9	Lat/Long: 47.472 -122.210	View Vicinity Map
Address:	601 S Grady Way Renton 98057	Township: 23N Range: 5E Section: 19	Legislative District: 11 Congressional District: 9

STATUS:	Cleanup Started	Rank:	View Site Web Page	View Site Documents
	Responsible Unit: Headquarters	Site Manager: Maurer, Christopher	Statute: MTCA	
	Is Brownfield?	Has Environmental Covenant?	Is PSI Site?	
	NFA Received?	NFA Date:	NFA Reason:	

ASSOCIATED CLEANUP UNIT(s)

culID	Cleanup Unit Name	Unit Type	Process Type	Unit Status	Size (Acres)	ERTS ID
2512	Renton Village Cleaners	Upland	Voluntary Cleanup Program	Cleanup Started		561155

SITE ACTIVITIES:

Applies to:	Related ID (Unit-LUST-VCP)	Activity Display Name	Status	Start Date	End Date	Legal Mechanism	Performed By	Project Manager
CleanupSite		Site Discovery/Release Report Received	Completed	7/25/2007	7/25/2007			Northwest Region
CleanupSite		Initial Investigation / Federal Preliminary Assessment	Completed	7/27/2007	7/27/2007		Ecology	Colburn, Gail
CleanupSite		Early Notice Letter(s)	Completed	8/6/2007	8/6/2007			Colburn, Gail
VcpProject	NW1914	VCP Opinion on Remedial Investigation	Completed	4/9/2008	5/1/2008			Hickey, Joe
VcpProject	NW1914	VCP Status Request	Completed	5/7/2013				Pederson, Carrie
VcpProject	NW1914	VCP Opinion on Interim Action	Completed	9/22/2008	12/11/2008			Nye, Roger
VcpProject	NW3017	VCP Receipt of Plan or Report	Completed	11/16/2015	11/16/2015			Fernandez, Sonia
VcpProject	NW3017	VCP Receipt of Plan or Report	Completed	7/24/2017	7/24/2017			Maurer, Christopher
VcpProject	NW3017	VCP Opinion on Site Cleanup	In Process	12/22/2015				Maurer, Christopher

AFFECTED MEDIA & CONTAMINANTS:

Media:

Contaminant:	Ground Water	Surface Water	Soil	Sediment	Air	Bedrock
Halogenated Organics	C		C			

Key:

B - Below Cleanup Level
C - Confirmed Above Cleanup Level
S - Suspected

R - Remediated
RA - Remediated-Above
RB - Remediated-Below

CleanupSiteDetails2014

KING COUNTY

SITE ID:	Service Linen Supply	Cleanup Site ID: 3382	FS ID: 12593698
-----------------	-----------------------------	-----------------------	-----------------

Alternate Name(s): Service Linen Supply, SERVICE LINEN SUPPLY INC

LOCATION:	WRIA: 9	Lat/Long: 47.478 -122.207	View Vicinity Map
Address: 903 S 4TH ST RENTON 98057-0659	Township: 23N	Range: 5E	Section: 17
			Legislative District: 37 Congressional District: 9

STATUS:	Cleanup Started	Rank:	View Site Web Page	View Site Documents
Responsible Unit:	Headquarters	Site Manager:	Cook, Jason	
Is Brownfield?		Has Environmental Covenant?	Statute: MTCA	
NFA Received?		NFA Date:	Is PSI Site?	
		NFA Reason:		

ASSOCIATED CLEANUP UNIT(s)

cuID	Cleanup Unit Name	Unit Type	Process Type	Unit Status	Size (Acres)	ERTS ID
3363	Service Linen Supply	Upland	Voluntary Cleanup Program	Cleanup Started		

SITE ACTIVITIES:

Applies to:	Related ID (Unit-LUST-VCP)	Activity Display Name	Status	Start Date	End Date	Legal Mechanism	Performed By	Project Manager
LUST		LUST - Notification	Completed	10/19/2000	10/19/2000			Bails, John
LUST		LUST - Report Received	Completed	2/1/2017	2/1/2017			
LUST		LUST - Report Received	Completed	10/19/2000	10/19/2000			
VcpProject	NW1637	VCP Opinion on Interim Action	Completed	6/6/2006	8/3/2006			Hickey, Joe
VcpProject	NW3113	VCP Opinion on Site Cleanup	Completed	2/1/2017	10/27/2017			Cook, Jason

AFFECTED MEDIA & CONTAMINANTS:

Media:

Contaminant:	Ground Water	Surface Water	Soil	Sediment	Air	Bedrock
Conventional Contaminants, Organic	C		C			
LUST - Other Hazardous Substance	C		C			
Non-Halogenated Solvents	C		C			
Petroleum-Gasoline	C		C			

Key:

B - Below Cleanup Level
C - Confirmed Above Cleanup Level
S - Suspected

R - Remediated
RA - Remediated-Above
RB - Remediated-Below

CleanupSiteDetails2014

KING COUNTY

SITE ID: **Texaco 632320402** Cleanup Site ID: 5313 FS ID: 3238112

Alternate Name(s): CHEVRON TEXACO 21-1549, GULL 1201, Texaco 632320402, Texaco Station 632320402

LOCATION: WRIA: 9 Lat/Long: 47.474 -122.207 [View Vicinity Map](#)

Address: 509 S GRADY WAY RENTON 98055 Township 23N Range 5E Section 19 Legislative District: 11 Congressional District: 9

STATUS: **Cleanup Started** Rank: [View Site Web Page](#) [View Site Documents](#)

Responsible Unit: Northwest Site Manager: Nye, Roger Statute: MTCA
 Is Brownfield? Has Environmental Covenant? Is PSI Site?
 NFA Received? NFA Date: NFA Reason:

ASSOCIATED CLEANUP UNIT(s)

culID	Cleanup Unit Name	Unit Type	Process Type	Unit Status	Size (Acres)	ERTS ID
4908	GULL 1201	Upland	Voluntary Cleanup Program	Cleanup Started		

SITE ACTIVITIES:

Applies to:	Related ID (Unit-LUST-VCP)	Activity Display Name	Status	Start Date	End Date	Legal Mechanism	Performed By	Project Manager
Milestone		Cleanup Action Plan	In Process	4/27/2005	12/31/2006			Northwest Region
LUST		LUST - Notification	Completed	8/28/1989	8/28/1989			
LUST		LUST - Report Received	Completed	3/9/1994	3/9/1994			
LUST		LUST - Report Received	Completed	12/16/2005	12/16/2005			
LUST		LUST - Report Received	Completed	6/22/1998	6/22/1998			
LUST		LUST - Report Received	Completed	2/11/1997	2/11/1997			
LUST		LUST - Report Received	Completed	3/12/1998	3/12/1998			
LUST		LUST - Report Received	Completed	4/25/2001	4/25/2001			
LUST		LUST - Report Received	Completed	4/16/1998	4/16/1998			
LUST		LUST - Report Received	Completed	7/6/2012	7/6/2012			
LUST		LUST - Report Received	Completed	10/13/1998	10/13/1998			
LUST		LUST - Report Received	Completed	12/17/2004	12/17/2004			
LUST		LUST - Report Received	Completed	3/12/1998	3/12/1998			

LUST		LUST - Report Received	Completed	1/29/2003	1/29/2003		
LUST		LUST - Report Received	Completed	3/7/1994	3/7/1994		
LUST		LUST - Report Received	Completed	2/11/1997	2/11/1997		
LUST		LUST - Report Received	Completed	10/16/1995	10/16/1995		
LUST		LUST - Report Received	Completed	4/21/1997	4/21/1997		
LUST		LUST - Report Received	Completed	1/22/2002	1/22/2002		
LUST		LUST - Report Received	Completed	3/31/1994	3/31/1994		
LUST		LUST - Report Received	Completed	2/11/1997	2/11/1997		
LUST		LUST - Report Received	Completed	10/13/1998	10/13/1998		
LUST		LUST - Report Received	Completed	5/30/1995	5/30/1995		
LUST		LUST - Report Received	Completed	8/26/1997	8/26/1997		
LUST		LUST - Report Received	Completed	4/24/1995	4/24/1995		
LUST		LUST - Report Received	Completed	10/16/1995	10/16/1995		
LUST		LUST - Report Received	Completed	8/23/1996	8/23/1996		
LUST		LUST - Report Received	Completed	9/30/2005	9/30/2005		
LUST		LUST - Report Received	Completed	11/11/1993	11/11/1993		
LUST		LUST - Report Received	Completed	12/23/2003	12/23/2003		
LUST		LUST - Report Received	Completed	12/19/1994	12/19/1994		
LUST		LUST - Report Received	Completed	1/7/1999	1/7/1999		
LUST		LUST - Report Received	Completed	3/2/2007	3/2/2007		
LUST		LUST - Report Received	Completed	8/9/2001	8/9/2001		
LUST		LUST - Report Received	Completed	10/19/2009	10/19/2009		
VcpProject	NW1450	VCP Status Request	In Process	7/7/2017			Fernandez, Sonia
VcpProject	NW1450	VCP Opinion on Cleanup Action Plan	Completed	4/27/2005			Adams, Mark
VcpProject	NW1450	VCP Opinion on Interim Action	Completed	3/19/2007			Adams, Mark
VcpProject	NW1450	VCP Opinion on Interim Action	Canceled	7/9/2008			Adams, Mark

AFFECTED MEDIA & CONTAMINANTS:

Media:

Contaminant:	Ground Water	Surface Water	Soil	Sediment	Air	Bedrock
Benzene	C		C			
Lead	C		C			
Metals Priority Pollutants	C		B			
Pesticides-Unspecified			C			
Petroleum-Gasoline	C		C			
Petroleum-Other	C		C			

Key:

B - Below Cleanup Level
C - Confirmed Above Cleanup Level
S - Suspected

R - Remediated
RA - Remediated-Above
RB - Remediated-Below

CleanupSiteDetails2014

KING COUNTY

SITE ID: **Lithia Dodge Chrysler Jeep** Cleanup Site ID: 5446 FS ID: 7826317

Alternate Name(s): Lithia Dodge Chrysler Jeep, PUGET SOUND CHRY PLY INC, PUGET SOUND CHRY-PLY INC, PUGET SOUND CHRYSLER PLYMOUTH INC

LOCATION: WRIA: 9 Lat/Long: 47.476 -122.215 [View Vicinity Map](#)

Address: 585 RAINIER AVE S Township Range Section Legislative District: 37
 RENTON 98055 23N 5E 18 Congressional District: 9

STATUS: **Cleanup Started** Rank: [View Site Web Page](#) [View Site Documents](#)

Responsible Unit: Northwest Site Manager: Northwest Region Statute: MTCA
 Is Brownfield? Has Environmental Covenant? Is PSI Site?
 NFA Received? NFA Date: NFA Reason:

ASSOCIATED CLEANUP UNIT(s)

culID	Cleanup Unit Name	Unit Type	Process Type	Unit Status	Size (Acres)	ERTS ID
5935	PUGET SOUND CHRYSLER PLYMOUTH	Upland	Independent Action	Cleanup Started		

SITE ACTIVITIES:

Applies to:	Related ID (Unit-LUST-VCP)	Activity Display Name	Status	Start Date	End Date	Legal Mechanism	Performed By	Project Manager
CleanupSite		Site Discovery/Release Report Received	Completed	9/30/1994	9/30/1994			Northwest Region
LUST		LUST - Notification	Completed	9/30/1994	9/30/1994			
LUST		LUST - Report Received	Completed	12/13/1993	12/13/1993			
LUST		LUST - Report Received	Completed	7/14/1994	7/14/1994			
LUST		LUST - Report Received	Completed	10/13/1993	10/13/1993			
LUST		LUST - Report Received	Completed	9/19/1994	9/19/1994			
LUST		LUST - Report Received	Completed	3/14/2007	3/14/2007			
LUST		LUST - Report Received	Completed	1/10/1995	1/10/1995			
LUST		LUST - Report Received	Completed	10/20/1997	10/20/1997			
LUST		LUST - Report Received	Completed	1/23/1995	1/23/1995			
LUST		LUST - Report Received	Completed	3/23/1994	3/23/1994			
LUST		LUST - Report Received	Completed	6/11/1996	6/11/1996			
VcpProject	NW0913	VCP Opinion on Cleanup Action	Completed	6/11/2002				Sato, Brian

AFFECTED MEDIA & CONTAMINANTS:

Media:

Contaminant:	Ground Water	Surface Water	Soil	Sediment	Air	Bedrock
Arsenic	C		S			
Benzene	C		C			
Lead	C		S			
Non-Halogenated Solvents	C		C			
Petroleum-Gasoline	C		C			
Petroleum-Other	C		C			

Key:

B - Below Cleanup Level
C - Confirmed Above Cleanup Level
S - Suspected

R - Remediated
RA - Remediated-Above
RB - Remediated-Below

CleanupSiteDetails2014

KING COUNTY

SITE ID: Walkers Renton Subaru Used Cars Cleanup Site ID: 5659 FS ID: 19684856

Alternate Name(s): SOUND SUBARU RENTON, WALKER SUBARU USED CAR LOT, Walkers Renton Subaru Used Cars

LOCATION: WRIA: 9 Lat/Long: 47.480 -122.217 [View Vicinity Map](#)

Address: 250 RAINIER AVE S RENTON 98057 Township 23N Range 5E Section 18 Legislative District: 37 Congressional District: 9

STATUS: Cleanup Started Rank: [View Site Web Page](#) [View Site Documents](#)

Responsible Unit: Northwest Site Manager: Northwest Region Statute: MTCA

Is Brownfield? Has Environmental Covenant? Is PSI Site?

NFA Received? NFA Date: NFA Reason:

ASSOCIATED CLEANUP UNIT(s)

cuID	Cleanup Unit Name	Unit Type	Process Type	Unit Status	Size (Acres)	ERTS ID
6291	SOUND SUBARU	Upland	Independent Action	Cleanup Started		

SITE ACTIVITIES:

Applies to:	Related ID (Unit-LUST-VCP)	Activity Display Name	Status	Start Date	End Date	Legal Mechanism	Performed By	Project Manager
LUST		LUST - Notification	Completed	4/8/1998	4/8/1998			
LUST		LUST - Report Received	Completed	3/8/2000	3/8/2000			
LUST		LUST - Report Received	Completed	3/8/2000	3/8/2000			
LUST		LUST - Report Received	Completed	3/8/2000	3/8/2000			
LUST		LUST - Report Received	Completed	4/8/1998	4/8/1998			
LUST		LUST - Report Received	Completed	11/12/2013	11/12/2013			
LUST		LUST - Report Received	Completed	11/12/2013	11/12/2013			
VcpProject	NW0420	VCP Opinion on Cleanup Action	Completed	3/8/2000	5/4/2000			Kuntz, Michael
VcpProject	NW0420	VCP Opinion on Cleanup Action	Completed	7/4/1776				Kuntz, Michael
VcpProject	NW2798	VCP Opinion on Remedial Investigation	Canceled	11/12/2013				Madakor, Nnamdi

AFFECTED MEDIA & CONTAMINANTS:

Media:

Contaminant:	Ground Water	Surface Water	Soil	Sediment	Air	Bedrock
Benzene	C		C			

Key:

B - Below Cleanup Level
 C - Confirmed Above Cleanup Level
 S - Suspected
 R - Remediated
 RA - Remediated-Above
 RB - Remediated-Below

Non-Halogenated Solvents	C		C			
Petroleum-Diesel	C		C			
Petroleum-Gasoline	C		C			
Petroleum-Other	C		C			

CleanupSiteDetails2014

KING COUNTY

SITE ID: **Sound Ford** Cleanup Site ID: 6342 FS ID: 58499353

Alternate Name(s): Sound Ford, SOUND FORD INC, SOUND FORD RENTON

LOCATION: WRIA: 9 Lat/Long: 47.473 -122.218 [View Vicinity Map](#)

Address: 750 RAINIER AVE S RENTON 98055 Township 23N Range 5E Section 19 Legislative District: 11 Congressional District: 9

STATUS: **Cleanup Started** Rank: [View Site Web Page](#) [View Site Documents](#)

Responsible Unit: Northwest Site Manager: Northwest Region Statute: MTCA
 Is Brownfield? Has Environmental Covenant? Is PSI Site?
 NFA Received? NFA Date: NFA Reason:

ASSOCIATED CLEANUP UNIT(s)

culID	Cleanup Unit Name	Unit Type	Process Type	Unit Status	Size (Acres)	ERTS ID
4881	SOUND FORD RENTON	Upland	Independent Action	Cleanup Started		602460

SITE ACTIVITIES:

Applies to:	Related ID (Unit-LUST-VCP)	Activity Display Name	Status	Start Date	End Date	Legal Mechanism	Performed By	Project Manager
CleanupSite		Site Discovery/Release Report Received	Completed	7/29/1989	7/29/1989			Northwest Region
CleanupSite		Site Discovery/Release Report Received	Completed	8/15/1989	8/15/1989			Northwest Region
CleanupSite		Initial Investigation / Federal Preliminary Assessment	Completed	11/10/2008	11/10/2008		Ecology	Reid, Wallace
CleanupSite		Early Notice Letter(s)	Completed	2/18/2009	2/18/2009			Reid, Wallace
LUST		LUST - Notification	Completed	7/27/1989	7/27/1989			
LUST		LUST - Report Received	Completed	10/4/1989	10/4/1989			
LUST		LUST - Report Received	Completed	10/4/1989	10/4/1989			

AFFECTED MEDIA & CONTAMINANTS:

Media:

Contaminant:	Ground Water	Surface Water	Soil	Sediment	Air	Bedrock
Benzene	S		C			
Petroleum-Gasoline	C		C			
Petroleum-Other	S		C			

Key:

B - Below Cleanup Level
 C - Confirmed Above Cleanup Level
 S - Suspected
 R - Remediated
 RA - Remediated-Above
 RB - Remediated-Below

CleanupSiteDetails2014

KING COUNTY

SITE ID: **LTS Trucking** Cleanup Site ID: 6558 FS ID: 71914167

Alternate Name(s): CASTAGNO BROTHERS, CASTAGNO-BROS, LTS Trucking, RENTON ISSAQUAH AUTO FREIGHTLINE

LOCATION: WRIA: 9 Lat/Long: 47.474 -122.212 [View Vicinity Map](#)

Address: 423 S 7TH ST RENTON 98055 Township 23N Range 5E Section 19 Legislative District: 11 Congressional District: 9

STATUS: **Cleanup Started** Rank: [View Site Web Page](#) [View Site Documents](#)

Responsible Unit: Northwest Site Manager: Northwest Region Statute: MTCA
 Is Brownfield? Has Environmental Covenant? Yes Is PSI Site?
 NFA Received? NFA Date: 1/29/1999 NFA Reason:

ASSOCIATED CLEANUP UNIT(s)

culID	Cleanup Unit Name	Unit Type	Process Type	Unit Status	Size (Acres)	ERTS ID
6426	LTS Trucking	Upland	Voluntary Cleanup Program	No Further Action Required		
15042	LTS Trucking (Off-Property)	Upland	No Process	Awaiting Cleanup		

SITE ACTIVITIES:

Applies to:	Related ID (Unit-LUST-VCP)	Activity Display Name	Status	Start Date	End Date	Legal Mechanism	Performed By	Project Manager
CleanupSite		Reopen Site	Completed	6/28/2011	6/28/2011			Northwest Region
CleanupSite		Site Status Changed to NFA	Completed	1/29/1999	1/29/1999			
CleanupSite <small>ActivityType</small>		Periodic Review	Completed	11/1/2014	11/1/2014			Freeman, Eugene
CleanupSite <small>ActivityType</small>		Periodic Review	Planned	10/1/2019				Freeman, Eugene
CleanupSite <small>ActivityType</small>		Periodic Review	Completed	11/2/2009	12/21/2009			Hickey, Joe
LUST		LUST - Notification	Completed	2/19/1998	2/19/1998			Forson, Ben
LUST		LUST - Site Characterization Report	Completed	1/10/1997	1/10/1997			
LUST		LUST - Report Received	Completed	8/10/1997	8/10/1997			
LUST		LUST - Report Received	Completed	2/12/1998	2/12/1998			
LUST		LUST - Report Received	Completed	5/10/1997	5/10/1997			
LUST		LUST - Report Received	Completed	10/30/1997	10/30/1997			
LUST		LUST - Report Received	Completed	2/19/1998	2/19/1998			

VcpProject	NW0033	VCP Opinion on Property Cleanup	Completed	6/28/2011	6/28/2011			Olsen, Russ
VcpProject	NW0033	VCP Opinion on Cleanup Action	Completed	2/19/1998	1/29/1999			Forson, Ben

AFFECTED MEDIA & CONTAMINANTS:

Media:

Contaminant:	Ground Water	Surface Water	Soil	Sediment	Air	Bedrock
Petroleum-Other	C		C			

Key:

B - Below Cleanup Level
C - Confirmed Above Cleanup Level
S - Suspected

R - Remediated
RA - Remediated-Above
RB - Remediated-Below

CleanupSiteDetails2014

KING COUNTY

SITE ID: **ARCO STATION 5207** Cleanup Site ID: 8164 FS ID: 17426998

Alternate Name(s): ARCO 05207, Arco 5207, ARCO STATION 5207, Renton Daily Grow Mart, RENTON DAILY GROW MART INC, RENTON EAGLE MART

LOCATION: WRIA: 8 Lat/Long: 47.489 -122.202 [View Vicinity Map](#)

Address: 401 PARK AVE N Township Range Section Legislative District: 37
 RENTON 98055 23N 5E 8 Congressional District: 9

STATUS: **Cleanup Started** Rank: [View Site Web Page](#) [View Site Documents](#)

Responsible Unit: Northwest Site Manager: Northwest Region Statute: MTCA
 Is Brownfield? Has Environmental Covenant? Is PSI Site?
 NFA Received? NFA Date: NFA Reason:

ASSOCIATED CLEANUP UNIT(s)

culID	Cleanup Unit Name	Unit Type	Process Type	Unit Status	Size (Acres)	ERTS ID
7856	ARCO STATION # 5207	Upland	Voluntary Cleanup Program	Cleanup Started		

SITE ACTIVITIES:

Applies to:	Related ID (Unit-LUST-VCP)	Activity Display Name	Status	Start Date	End Date	Legal Mechanism	Performed By	Project Manager
LUST		LUST - Notification	Completed	12/15/1989	12/15/1989			
LUST		LUST - Report Received	Completed	1/22/2010	1/22/2010			
LUST		LUST - Report Received	Completed	3/4/2009	3/4/2009			
LUST		LUST - Report Received	Completed	3/3/2000	3/3/2000			
LUST		LUST - Report Received	Completed	7/24/1991	7/24/1991			
LUST		LUST - Report Received	Completed	6/7/2010	6/7/2010			
LUST		LUST - Report Received	Completed	6/24/1991	6/24/1991			
LUST		LUST - Report Received	Completed	4/21/2006	4/21/2006			
LUST		LUST - Report Received	Completed	4/30/1999	4/30/1999			
LUST		LUST - Report Received	Completed	7/22/1993	7/22/1993			
LUST		LUST - Report Received	Completed	2/10/1997	2/10/1997			
LUST		LUST - Report Received	Completed	11/30/1993	11/30/1993			
LUST		LUST - Report Received	Completed	3/15/2007	3/15/2007			

LUST		LUST - Report Received	Completed	9/23/1999	9/23/1999				
LUST		LUST - Report Received	Completed	10/26/1998	10/26/1998				
LUST		LUST - Report Received	Completed	3/19/1991	3/19/1991				
LUST		LUST - Report Received	Completed	10/21/2005	10/21/2005				
LUST		LUST - Report Received	Completed	12/15/1995	12/15/1995				
LUST		LUST - Report Received	Completed	5/24/2001	5/24/2001				
LUST		LUST - Report Received	Completed	4/28/2008	4/28/2008				
LUST		LUST - Report Received	Completed	2/7/1996	2/7/1996				
LUST		LUST - Report Received	Completed	4/24/2003	4/24/2003				
LUST		LUST - Report Received	Completed	10/27/1997	10/27/1997				
LUST		LUST - Report Received	Completed	2/19/1993	2/19/1993				
LUST		LUST - Report Received	Completed	1/22/2010	1/22/2010				
LUST		LUST - Report Received	Completed	7/22/1997	7/22/1997				
LUST		LUST - Report Received	Completed	5/17/1994	5/17/1994				
LUST		LUST - Report Received	Completed	2/7/2002	2/7/2002				
LUST		LUST - Report Received	Completed	4/6/1990	4/6/1990				
LUST		LUST - Report Received	Completed	10/14/2008	10/14/2008				
LUST		LUST - Report Received	Completed	11/9/1996	11/9/1996				
LUST		LUST - Report Received	Completed	3/24/2004	3/24/2004				
LUST		LUST - Report Received	Completed	11/6/2000	11/6/2000				
LUST		LUST - Report Received	Completed	6/12/1992	6/12/1992				
LUST		LUST - Report Received	Completed	8/24/2006	8/24/2006				
LUST		LUST - Report Received	Completed	8/10/1993	8/10/1993				
LUST		LUST - Report Received	Completed	10/20/2004	10/20/2004				
LUST		LUST - Report Received	Completed	4/11/1995	4/11/1995				
LUST		LUST - Report Received	Completed	4/5/1993	4/5/1993				
LUST		LUST - Report Received	Completed	12/23/2003	12/23/2003				
LUST		LUST - Report Received	Completed	8/25/1994	8/25/1994				

LUST		LUST - Report Received	Completed	2/11/2005	2/11/2005				
LUST		LUST - Report Received	Completed	4/10/1998	4/10/1998				
LUST		LUST - Report Received	Completed	10/25/2007	10/25/2007				
LUST		LUST - Report Received	Completed	1/16/1995	1/16/1995				
LUST		LUST - Report Received	Completed	9/9/2010	9/9/2010				
LUST		LUST - Report Received	Completed	9/8/2010	9/8/2010				
LUST		LUST - Report Received	Completed	11/22/2010	11/22/2010				
LUST		LUST - Report Received	Completed	2/9/2011	2/9/2011				
LUST		LUST - Report Received	Completed	2/8/2012	2/8/2012				
LUST		LUST - Report Received	Completed	2/21/2013	2/21/2013				
LUST		LUST - Report Received	Completed	11/1/2011	11/1/2011				
LUST		LUST - Report Received	Completed	3/5/2015	3/5/2015				
LUST		LUST - Report Received	Completed	4/14/2015	4/14/2015				
LUST		LUST - Report Received	Completed	10/24/2014	10/24/2014				
LUST		LUST - Report Received	Completed	7/2/2015	7/2/2015				
LUST		LUST - Report Received	Completed	4/27/2014	4/27/2014				
VcpProject	NW2467	VCP Opinion on Site Cleanup	Completed	3/5/2015	8/2/2016				Fernandez, Sonia

AFFECTED MEDIA & CONTAMINANTS:

Media:

Contaminant:	Ground Water	Surface Water	Soil	Sediment	Air	Bedrock
Benzene	C		C			
Petroleum-Gasoline	C		C			

Key:

B - Below Cleanup Level
C - Confirmed Above Cleanup Level
S - Suspected

R - Remediated
RA - Remediated-Above
RB - Remediated-Below

CleanupSiteDetails2014

KING COUNTY

SITE ID: **Brown Bear Car Wash 2422** Cleanup Site ID: 8561 FS ID: 27778869

Alternate Name(s): Brown Bear Car Wash 2422, Car Wash Enterprises, RENTON 1

LOCATION: WRIA: 9 Lat/Long: 47.474 -122.216 [View Vicinity Map](#)

Address: 621 & 641 RAINIER AVE S RENTON 98055-2410
 Township: 23N Range: 5E Section: 18
 Legislative District: 11 Congressional District: 9

STATUS: **Cleanup Started** Rank: [View Site Web Page](#) [View Site Documents](#)

Responsible Unit: Northwest Site Manager: Northwest Region Statute: MTCA
 Is Brownfield? Has Environmental Covenant? Is PSI Site?
 NFA Received? NFA Date: NFA Reason:

ASSOCIATED CLEANUP UNIT(s)

culID	Cleanup Unit Name	Unit Type	Process Type	Unit Status	Size (Acres)	ERTS ID
12682	Car Wash Enterprises Renton (Off-Property)	Upland	No Process	Cleanup Started		
8253	Car Wash Enterprises Renton (Property)	Upland	Voluntary Cleanup Program	No Further Action Required		

SITE ACTIVITIES:

Applies to:	Related ID (Unit-LUST-VCP)	Activity Display Name	Status	Start Date	End Date	Legal Mechanism	Performed By	Project Manager
CleanupSite		Site Discovery/Release Report Received	Completed	8/19/2010	8/19/2010			Northwest Region
LUST		LUST - Notification	Completed	4/12/1991	4/12/1991			
LUST		LUST - Report Received	Completed	10/26/1999	10/26/1999			
LUST		LUST - Report Received	Completed	9/2/1992	9/2/1992			
LUST		LUST - Report Received	Completed	8/1/2003	8/1/2003			
LUST		LUST - Report Received	Completed	5/30/1997	5/30/1997			
LUST		LUST - Report Received	Completed	1/28/2005	1/28/2005			
LUST		LUST - Report Received	Completed	11/7/1997	11/7/1997			
LUST		LUST - Report Received	Completed	11/2/1993	11/2/1993			
LUST		LUST - Report Received	Completed	9/12/2002	9/12/2002			
LUST		LUST - Report Received	Completed	8/2/1999	8/2/1999			
LUST		LUST - Report Received	Completed	8/20/2001	8/20/2001			

LUST		LUST - Report Received	Completed	6/7/2004	6/7/2004				
LUST		LUST - Report Received	Completed	1/4/2001	1/4/2001				
LUST		LUST - Report Received	Completed	11/1/2004	11/1/2004				
LUST		LUST - Report Received	Completed	7/18/2000	7/18/2000				
LUST		LUST - Report Received	Completed	9/30/1992	9/30/1992				
LUST		LUST - Report Received	Completed	8/25/1998	8/25/1998				
LUST		LUST - Report Received	Completed	1/31/2003	1/31/2003				
LUST		LUST - Report Received	Completed	9/28/1998	9/28/1998				
LUST		LUST - Report Received	Completed	5/28/1992	5/28/1992				
LUST		LUST - Report Received	Completed	12/29/1998	12/29/1998				
LUST		LUST - Report Received	Completed	8/28/2003	8/28/2003				
LUST		LUST - Report Received	Completed	5/9/1997	5/9/1997				
LUST		LUST - Report Received	Completed	4/15/1991	4/15/1991				
LUST		LUST - Report Received	Completed	9/16/2005	9/16/2005				
LUST		LUST - Report Received	Completed	7/17/2000	7/17/2000				
LUST		LUST - Report Received	Completed	9/17/1993	9/17/1993				
LUST		LUST - Report Received	Completed	9/10/1993	9/10/1993				
LUST		LUST - Report Received	Completed	4/15/1991	4/15/1991				
LUST		LUST - Report Received	Completed	2/26/1998	2/26/1998				
LUST		LUST - Report Received	Completed	1/29/2003	1/29/2003				
LUST		LUST - Report Received	Completed	2/4/2002	2/4/2002				
LUST		LUST - Report Received	Completed	10/18/1993	10/18/1993				
LUST		LUST - Report Received	Completed	2/2/2000	2/2/2000				
LUST		LUST - Report Received	Completed	5/7/2003	5/7/2003				
LUST		LUST - Report Received	Completed	8/25/1998	8/25/1998				
LUST		LUST - Report Received	Completed	9/10/1992	9/10/1992				
LUST		LUST - Report Received	Completed	9/6/1996	9/6/1996				
LUST		LUST - Report Received	Completed	5/9/2002	5/9/2002				

LUST		LUST - Report Received	Completed	12/7/1992	12/7/1992				
LUST		LUST - Report Received	Completed	3/18/1999	3/18/1999				
LUST		LUST - Report Received	Completed	10/4/2005	10/4/2005				
LUST		LUST - Report Received	Completed	7/29/2010	7/29/2010				
LUST		LUST - Report Received	Completed	7/29/2010	7/29/2010				
LUST		LUST - Report Received	Completed	7/29/2010	7/29/2010				
LUST		LUST - Report Received	Completed	7/29/2010	7/29/2010				
LUST		LUST - Report Received	Completed	11/15/2010	11/15/2010				
LUST		LUST - Report Received	Completed	7/29/2010	7/29/2010				
LUST		LUST - Report Received	Completed	1/3/2012	1/3/2012				
LUST		LUST - Report Received	Completed	10/15/2012	10/15/2012				
VcpProject	NW2327	VCP Receipt of Plan or Report	Completed	10/15/2012	10/15/2012				Pederson, Carrie
VcpProject	NW2327	VCP Receipt of Plan or Report	Completed	1/3/2012	1/3/2012				Fernandez, Sonia
VcpProject	NW2327	VCP Opinion on Remedial Investigation Work Plan	Completed	11/15/2010	12/13/2010				Liu, Jing
VcpProject	NW2327	VCP Opinion on Site Cleanup	Completed	1/6/2012	4/12/2012				Vick, Heather
VcpProject	NW2327	VCP Opinion on Site Cleanup	Completed	10/15/2012	1/10/2013				Vick, Heather
LUST		LUST - Notification	Completed	1/10/2013	1/10/2013				Northwest Region
LUST		LUST - Report Received	Completed	1/3/2012	1/3/2012				

AFFECTED MEDIA & CONTAMINANTS:

Media:

Contaminant:	Ground Water	Surface Water	Soil	Sediment	Air	Bedrock
Benzene	C		C			
Non-Halogenated Solvents	RB		RB			
Petroleum-Gasoline	C		C			

Key:

B - Below Cleanup Level
C - Confirmed Above Cleanup Level
S - Suspected

R - Remediated
RA - Remediated-Above
RB - Remediated-Below

CleanupSiteDetails2014

KING COUNTY

SITE ID: **Chevron 99114** Cleanup Site ID: 10476 FS ID: 77287947

Alternate Name(s): AABRA INC, CHEVRON 99114, CHEVRON SS 99114, GRADY WAY CHEVRON

LOCATION: WRIA: 9 Lat/Long: 47.471 -122.216 [View Vicinity Map](#)

Address: 301 S GRADY WAY RENTON 98055 Township 23N Range 5E Section 19 Legislative District: 11 Congressional District: 9

STATUS: **Cleanup Started** Rank: [View Site Web Page](#) [View Site Documents](#)

Responsible Unit: Northwest Site Manager: Northwest Region Statute: MTCA

Is Brownfield? Has Environmental Covenant? Is PSI Site?

NFA Received? NFA Date: NFA Reason:

ASSOCIATED CLEANUP UNIT(s)

cuID	Cleanup Unit Name	Unit Type	Process Type	Unit Status	Size (Acres)	ERTS ID
10168	CHEVRON 99114	Upland	Independent Action	Cleanup Started		

SITE ACTIVITIES:

Applies to:	Related ID (Unit-LUST-VCP)	Activity Display Name	Status	Start Date	End Date	Legal Mechanism	Performed By	Project Manager
LUST		LUST - Notification	Completed	4/5/1991	4/5/1991			
LUST		LUST - Report Received	Completed	12/22/2005	12/22/2005			
LUST		LUST - Report Received	Completed	1/4/1994	1/4/1994			
LUST		LUST - Report Received	Completed	3/4/2010	3/4/2010			
LUST		LUST - Report Received	Completed	5/12/2008	5/12/2008			
LUST		LUST - Report Received	Completed	8/2/1999	8/2/1999			
LUST		LUST - Report Received	Completed	1/29/2003	1/29/2003			
LUST		LUST - Report Received	Completed	4/24/1995	4/24/1995			
LUST		LUST - Report Received	Completed	1/25/2002	1/25/2002			
LUST		LUST - Report Received	Completed	7/5/2007	7/5/2007			
LUST		LUST - Report Received	Completed	12/8/1997	12/8/1997			
LUST		LUST - Report Received	Completed	1/14/2004	1/14/2004			
LUST		LUST - Report Received	Completed	9/16/1993	9/16/1993			

LUST		LUST - Report Received	Completed	1/11/2000	1/11/2000				
LUST		LUST - Report Received	Completed	4/3/1996	4/3/1996				
LUST		LUST - Report Received	Completed	3/4/1998	3/4/1998				
LUST		LUST - Report Received	Completed	10/10/1994	10/10/1994				
LUST		LUST - Report Received	Completed	5/7/2001	5/7/2001				
LUST		LUST - Report Received	Completed	8/7/1996	8/7/1996				
LUST		LUST - Report Received	Completed	1/13/1995	1/13/1995				
LUST		LUST - Report Received	Completed	7/12/1994	7/12/1994				
LUST		LUST - Report Received	Completed	1/6/1995	1/6/1995				
LUST		LUST - Report Received	Completed	3/8/1994	3/8/1994				
LUST		LUST - Report Received	Completed	10/1/2009	10/1/2009				
LUST		LUST - Report Received	Completed	7/25/1994	7/25/1994				
LUST		LUST - Report Received	Completed	8/10/2009	8/10/2009				
LUST		LUST - Report Received	Completed	1/6/2005	1/6/2005				
LUST		LUST - Report Received	Completed	7/10/1991	7/10/1991				
LUST		LUST - Report Received	Completed	7/12/1993	7/12/1993				
LUST		LUST - Report Received	Completed	9/25/1995	9/25/1995				
LUST		LUST - Report Received	Completed	11/6/2003	11/6/2003				
LUST		LUST - Report Received	Completed	11/13/1995	11/13/1995				
LUST		LUST - Report Received	Completed	11/15/2007	11/15/2007				
LUST		LUST - Report Received	Completed	6/30/1993	6/30/1993				
LUST		LUST - Report Received	Completed	6/20/1994	6/20/1994				
LUST		LUST - Report Received	Completed	11/3/2006	11/3/2006				
LUST		LUST - Report Received	Completed	4/21/1994	4/21/1994				
LUST		LUST - Report Received	Completed	1/23/2001	1/23/2001				
LUST		LUST - Report Received	Completed	10/5/1994	10/5/1994				
LUST		LUST - Report Received	Completed	10/24/1996	10/24/1996				
LUST		LUST - Report Received	Completed	7/25/1996	7/25/1996				

LUST		LUST - Report Received	Completed	11/4/1993	11/4/1993				
LUST		LUST - Report Received	Completed	10/14/1991	10/14/1991				
LUST		LUST - Report Received	Completed	5/5/1993	5/5/1993				
LUST		LUST - Report Received	Completed	1/28/1992	1/28/1992				
LUST		LUST - Report Received	Completed	1/9/2012	1/9/2012				
LUST		LUST - Report Received	Completed	7/6/2011	7/6/2011				
LUST		LUST - Report Received	Completed	1/10/2011	1/10/2011				
LUST		LUST - Report Received	Completed	5/6/2011	5/6/2011				

AFFECTED MEDIA & CONTAMINANTS:

Media:

Contaminant:	Ground Water	Surface Water	Soil	Sediment	Air	Bedrock
Benzene	C		C			
Petroleum-Gasoline	C		C			

Key:

B - Below Cleanup Level
C - Confirmed Above Cleanup Level
S - Suspected

R - Remediated
RA - Remediated-Above
RB - Remediated-Below

CleanupSiteDetails2014

KING COUNTY

SITE ID: **Taylor Auto Body** Cleanup Site ID: 9662 FS ID: 54887792

Alternate Name(s): Taylor Auto Body, TAYLOR'S AUTO BODY, Taylors Auto Body

LOCATION: WRIA: 9 Lat/Long: 47.479 -122.205 [View Vicinity Map](#)

Address: 330 MAIN AVE S RENTON 98057 Township 23N Range 5E Section 17 Legislative District: 37 Congressional District: 9

STATUS: **Cleanup Started** Rank: [View Site Web Page](#) [View Site Documents](#)

Responsible Unit: Headquarters Site Manager: Maurer, Christopher Statute: MTCA
 Is Brownfield? Has Environmental Covenant? Is PSI Site?
 NFA Received? NFA Date: 10/3/2011 NFA Reason:

ASSOCIATED CLEANUP UNIT(s)

cuID	Cleanup Unit Name	Unit Type	Process Type	Unit Status	Size (Acres)	ERTS ID
9354	TAYLOR AUTO BODY	Upland	Voluntary Cleanup Program	Cleanup Started		

SITE ACTIVITIES:

Applies to:	Related ID (Unit-LUST-VCP)	Activity Display Name	Status	Start Date	End Date	Legal Mechanism	Performed By	Project Manager
CleanupSite		Site Discovery/Release Report Received	Completed	10/10/1990	10/10/1990			Northwest Region
CleanupSite		Initial Investigation / Federal Preliminary Assessment	Completed	8/8/2011	8/8/2011		Ecology w/ Contractor	Olsen, Russ
CleanupSite		Reopen Site	Completed	12/23/2013	12/23/2013			Fernandez, Sonia
CleanupSite		Site Status Changed to NFA	Completed	10/3/2011	10/3/2011			Olsen, Russ
LUST		LUST - Notification	Completed	10/10/1990	10/10/1990			
LUST		LUST - Report Received	Completed	12/23/2013	12/23/2013			
LUST		LUST - Report Received	Completed	12/23/2013	12/23/2013			
LUST		LUST - Report Received	Completed	12/23/2013	12/23/2013			
LUST		LUST - Report Received	Completed	12/23/2013	12/23/2013			
LUST		LUST - Report Received	Completed	12/23/2013	12/23/2013			
LUST		LUST - Report Received	Completed	7/3/2017	7/3/2017			
LUST		LUST - Report Received	Completed	7/3/2017	7/3/2017			
LUST		LUST - Report Received	Completed	12/21/2016	12/21/2016			

LUST		LUST - Report Received	Completed	9/10/2014	9/10/2014			
LUST		LUST - Report Received	Completed	11/29/2017	11/29/2017			
LUST		LUST - Report Received	Completed	8/29/1990	8/29/1990			
LUST		LUST - Report Received	Completed	11/16/1990	11/16/1990			
VcpProject	NW2814	VCP Receipt of Plan or Report	Completed	12/5/2017	12/5/2017			Maurer, Christopher
VcpProject	NW2814	VCP Opinion on Remedial Investigation Work Plan	In Process	3/24/2017				Northwest Region
VcpProject	NW2814	VCP Opinion on Remedial Investigation	Completed	12/23/2013	2/28/2014			Freier-Coppinger, Romy
VcpProject	NW2814	VCP Status Request	Completed	5/13/2016	12/21/2016			Bardy, Louise

AFFECTED MEDIA & CONTAMINANTS:

Media:

Contaminant:	Ground Water	Surface Water	Soil	Sediment	Air	Bedrock
Benzene			S			
Other Non-Halogenated Organics			C			
Petroleum-Gasoline			C			
Petroleum-Other			C			

Key:

B - Below Cleanup Level
C - Confirmed Above Cleanup Level
S - Suspected

R - Remediated
RA - Remediated-Above
RB - Remediated-Below

CleanupSiteDetails2014

KING COUNTY

SITE ID: **Sears Svc Ctr Old Renton Shopping** Cleanup Site ID: 9860 FS ID: 60178828

Alternate Name(s): SEARS ROEBUCK & CO RENTON, SEARS ROEBUCK & CO UST 7842, Sears Svc Ctr Old Renton Shopping

LOCATION: WRIA: 9 Lat/Long: 47.477 -122.219 [View Vicinity Map](#)

Address: 359 RENTON CENTER WAY SW Township Range Section Legislative District: 11
 RENTON 98055-2393 23N 5E 18 Congressional District: 9

STATUS: **Cleanup Started** Rank: [View Site Web Page](#) [View Site Documents](#)

Responsible Unit: Northwest Site Manager: Northwest Region Statute: MTCA
 Is Brownfield? Has Environmental Covenant? Is PSI Site?
 NFA Received? NFA Date: NFA Reason:

ASSOCIATED CLEANUP UNIT(s)

cuID	Cleanup Unit Name	Unit Type	Process Type	Unit Status	Size (Acres)	ERTS ID
9552	Sears Svc Ctr Old Renton Shopping	Upland	Independent Action	Cleanup Started		

SITE ACTIVITIES:

Applies to:	Related ID (Unit-LUST-VCP)	Activity Display Name	Status	Start Date	End Date	Legal Mechanism	Performed By	Project Manager
LUST		LUST - Notification	Completed	11/18/1994	11/18/1994			
LUST		LUST - Site Characterization Report	Completed	2/13/2003	2/13/2003			
LUST		LUST - Report Received	Completed	1/4/1995	1/4/1995			

AFFECTED MEDIA & CONTAMINANTS:

Media:

Contaminant:	Ground Water	Surface Water	Soil	Sediment	Air	Bedrock
Petroleum-Diesel	C		C			

Key:

B - Below Cleanup Level
 C - Confirmed Above Cleanup Level
 S - Suspected
 R - Remediated
 RA - Remediated-Above
 RB - Remediated-Below

KING COUNTY

SITE ID:	SDS Partners Property	Cleanup Site ID: 9972	FS ID: 63618514
-----------------	------------------------------	-----------------------	-----------------

Alternate Name(s): SDS PARTNERS, SDS Partners Property

LOCATION:	WRIA: 8	Lat/Long: 47.485 -122.212	View Vicinity Map
Address: 307 AIRPORT WAY RENTON 98057	Township: 23N	Range: 5E	Section: 18
	Legislative District: 37	Congressional District: 9	

STATUS:	Cleanup Started	Rank:	View Site Web Page	View Site Documents
Responsible Unit: Northwest	Site Manager: Northwest Region	Statute: MTCA		
Is Brownfield?	Has Environmental Covenant?	Is PSI Site?		
NFA Received?	NFA Date:	NFA Reason:		

ASSOCIATED CLEANUP UNIT(s)

cuID	Cleanup Unit Name	Unit Type	Process Type	Unit Status	Size (Acres)	ERTS ID
9664	SDS Partners Property	Upland	Independent Action	Cleanup Started		

SITE ACTIVITIES:

Applies to:	Related ID (Unit-LUST-VCP)	Activity Display Name	Status	Start Date	End Date	Legal Mechanism	Performed By	Project Manager
LUST		LUST - Notification	Completed	7/12/1993	7/12/1993			
LUST		LUST - Report Received	Completed	11/1/1993	11/1/1993			

AFFECTED MEDIA & CONTAMINANTS:

Media:

Contaminant:	Ground Water	Surface Water	Soil	Sediment	Air	Bedrock
Petroleum-Other	C		C			

Key:

B - Below Cleanup Level
C - Confirmed Above Cleanup Level
S - Suspected

R - Remediated
RA - Remediated-Above
RB - Remediated-Below

CleanupSiteDetails2014

KING COUNTY

SITE ID: **Chevron 99114** Cleanup Site ID: 10476 FS ID: 77287947

Alternate Name(s): AABRA INC, CHEVRON 99114, CHEVRON SS 99114, GRADY WAY CHEVRON

LOCATION: WRIA: 9 Lat/Long: 47.471 -122.216 [View Vicinity Map](#)

Address: 301 S GRADY WAY RENTON 98055 Township 23N Range 5E Section 19 Legislative District: 11 Congressional District: 9

STATUS: **Cleanup Started** Rank: [View Site Web Page](#) [View Site Documents](#)

Responsible Unit: Northwest Site Manager: Northwest Region Statute: MTCA
 Is Brownfield? Has Environmental Covenant? Is PSI Site?
 NFA Received? NFA Date: NFA Reason:

ASSOCIATED CLEANUP UNIT(s)

culID	Cleanup Unit Name	Unit Type	Process Type	Unit Status	Size (Acres)	ERTS ID
10168	CHEVRON 99114	Upland	Independent Action	Cleanup Started		

SITE ACTIVITIES:

Applies to:	Related ID (Unit-LUST-VCP)	Activity Display Name	Status	Start Date	End Date	Legal Mechanism	Performed By	Project Manager
LUST		LUST - Notification	Completed	4/5/1991	4/5/1991			
LUST		LUST - Report Received	Completed	12/22/2005	12/22/2005			
LUST		LUST - Report Received	Completed	1/4/1994	1/4/1994			
LUST		LUST - Report Received	Completed	3/4/2010	3/4/2010			
LUST		LUST - Report Received	Completed	5/12/2008	5/12/2008			
LUST		LUST - Report Received	Completed	8/2/1999	8/2/1999			
LUST		LUST - Report Received	Completed	1/29/2003	1/29/2003			
LUST		LUST - Report Received	Completed	4/24/1995	4/24/1995			
LUST		LUST - Report Received	Completed	1/25/2002	1/25/2002			
LUST		LUST - Report Received	Completed	7/5/2007	7/5/2007			
LUST		LUST - Report Received	Completed	12/8/1997	12/8/1997			
LUST		LUST - Report Received	Completed	1/14/2004	1/14/2004			
LUST		LUST - Report Received	Completed	9/16/1993	9/16/1993			

LUST		LUST - Report Received	Completed	1/11/2000	1/11/2000				
LUST		LUST - Report Received	Completed	4/3/1996	4/3/1996				
LUST		LUST - Report Received	Completed	3/4/1998	3/4/1998				
LUST		LUST - Report Received	Completed	10/10/1994	10/10/1994				
LUST		LUST - Report Received	Completed	5/7/2001	5/7/2001				
LUST		LUST - Report Received	Completed	8/7/1996	8/7/1996				
LUST		LUST - Report Received	Completed	1/13/1995	1/13/1995				
LUST		LUST - Report Received	Completed	7/12/1994	7/12/1994				
LUST		LUST - Report Received	Completed	1/6/1995	1/6/1995				
LUST		LUST - Report Received	Completed	3/8/1994	3/8/1994				
LUST		LUST - Report Received	Completed	10/1/2009	10/1/2009				
LUST		LUST - Report Received	Completed	7/25/1994	7/25/1994				
LUST		LUST - Report Received	Completed	8/10/2009	8/10/2009				
LUST		LUST - Report Received	Completed	1/6/2005	1/6/2005				
LUST		LUST - Report Received	Completed	7/10/1991	7/10/1991				
LUST		LUST - Report Received	Completed	7/12/1993	7/12/1993				
LUST		LUST - Report Received	Completed	9/25/1995	9/25/1995				
LUST		LUST - Report Received	Completed	11/6/2003	11/6/2003				
LUST		LUST - Report Received	Completed	11/13/1995	11/13/1995				
LUST		LUST - Report Received	Completed	11/15/2007	11/15/2007				
LUST		LUST - Report Received	Completed	6/30/1993	6/30/1993				
LUST		LUST - Report Received	Completed	6/20/1994	6/20/1994				
LUST		LUST - Report Received	Completed	11/3/2006	11/3/2006				
LUST		LUST - Report Received	Completed	4/21/1994	4/21/1994				
LUST		LUST - Report Received	Completed	1/23/2001	1/23/2001				
LUST		LUST - Report Received	Completed	10/5/1994	10/5/1994				
LUST		LUST - Report Received	Completed	10/24/1996	10/24/1996				
LUST		LUST - Report Received	Completed	7/25/1996	7/25/1996				

LUST		LUST - Report Received	Completed	11/4/1993	11/4/1993				
LUST		LUST - Report Received	Completed	10/14/1991	10/14/1991				
LUST		LUST - Report Received	Completed	5/5/1993	5/5/1993				
LUST		LUST - Report Received	Completed	1/28/1992	1/28/1992				
LUST		LUST - Report Received	Completed	1/9/2012	1/9/2012				
LUST		LUST - Report Received	Completed	7/6/2011	7/6/2011				
LUST		LUST - Report Received	Completed	1/10/2011	1/10/2011				
LUST		LUST - Report Received	Completed	5/6/2011	5/6/2011				

AFFECTED MEDIA & CONTAMINANTS:

Media:

Contaminant:	Ground Water	Surface Water	Soil	Sediment	Air	Bedrock
Benzene	C		C			
Petroleum-Gasoline	C		C			

Key:

B - Below Cleanup Level
C - Confirmed Above Cleanup Level
S - Suspected

R - Remediated
RA - Remediated-Above
RB - Remediated-Below

CleanupSiteDetails2014

KING COUNTY

SITE ID: **USA Petroleum 115** Cleanup Site ID: 11155 FS ID: 94569877

Alternate Name(s): Evans Tire Svc Ctrs 040, EVANS TIRE SVC CTRS 064, MOBIL #68406, Mobil 68406, TESORO 68406, TESORO WEST COAST COMPANY LLC 68406, USA MINI MART 115, USA Petroleum 115, USA PETROLEUM CORP 115

LOCATION: WRIA: 9 Lat/Long: 47.472 -122.218 [View Vicinity Map](#)
Address: 765 RAINIER AVE S Township Range Section Legislative District: 11
 RENTON 98055 23N 5E 19 Congressional District: 9

STATUS: **Cleanup Started** Rank: [View Site Web Page](#) [View Site Documents](#)
 Responsible Unit: Northwest Site Manager: Warfel, Michael Statute: MTCA
 Is Brownfield? Has Environmental Covenant? Is PSI Site?
 NFA Received? NFA Date: NFA Reason:

ASSOCIATED CLEANUP UNIT(s)

culID	Cleanup Unit Name	Unit Type	Process Type	Unit Status	Size (Acres)	ERTS ID
10847	USA Petroleum 115	Upland	Voluntary Cleanup Program	Cleanup Started		616780 639781

SITE ACTIVITIES:

Applies to:	Related ID (Unit-LUST-VCP)	Activity Display Name	Status	Start Date	End Date	Legal Mechanism	Performed By	Project Manager
CleanupSite		Site Discovery/Release Report Received	Completed	11/8/1990	11/8/1990			Northwest Region
CleanupSite		Initial Investigation / Federal Preliminary Assessment	Completed	3/20/2013	3/20/2013		Ecology	Zouboulakis, Chris
CleanupSite		Early Notice Letter(s)	Completed	12/3/2013	12/3/2013			Musa, Donna
CleanupSite		Early Notice Letter(s)	Completed	10/4/2013	10/4/2013			Musa, Donna
LUST		LUST - Notification	Completed	11/8/1990	11/8/1990			
LUST		LUST - Site Assessment Report	Completed	2/14/2018	2/14/2018			
LUST		LUST - Report Received	Completed	2/2/2007	2/2/2007			
LUST		LUST - Report Received	Completed	1/22/2003	1/22/2003			
LUST		LUST - Report Received	Completed	9/16/2005	9/16/2005			
LUST		LUST - Report Received	Completed	5/22/2013	5/22/2013			
LUST		LUST - Report Received	Completed	8/20/2014	8/20/2014			
LUST		LUST - Report Received	Completed	9/22/2014	9/22/2014			
LUST		LUST - Report Received	Completed	8/13/2013	8/13/2013			

LUST		LUST - Report Received	Completed	10/11/2013	10/11/2013				
LUST		LUST - Report Received	Completed	3/12/2014	3/12/2014				
LUST		LUST - Report Received	Completed	4/4/2014	4/4/2014				
LUST		LUST - Report Received	Completed	9/29/2015	9/29/2015				
LUST		LUST - Report Received	Completed	9/28/2015	9/28/2015				
LUST		LUST - Report Received	Completed	12/23/2013	12/23/2013				
LUST		LUST - Report Received	Completed	6/6/2016	6/6/2016				
LUST		LUST - Report Received	Completed	1/11/2016	1/11/2016				
LUST		LUST - Report Received	Completed	5/12/2017	5/12/2017				
LUST		LUST - Report Received	Completed	5/9/2017	5/9/2017				
LUST		LUST - Report Received	Completed	8/3/2017	8/3/2017				
LUST		LUST - Report Received	Completed	7/6/2005	7/6/2005				
LUST		LUST - Report Received	Completed	4/21/2003	4/21/2003				
LUST		LUST - Report Received	Completed	10/24/1994	10/24/1994				
LUST		LUST - Report Received	Completed	11/18/2008	11/18/2008				
LUST		LUST - Report Received	Completed	7/7/2006	7/7/2006				
LUST		LUST - Report Received	Completed	6/25/2001	6/25/2001				
LUST		LUST - Report Received	Completed	7/23/2007	7/23/2007				
LUST		LUST - Report Received	Completed	1/22/2001	1/22/2001				
LUST		LUST - Report Received	Completed	7/15/2004	7/15/2004				
LUST		LUST - Report Received	Completed	9/23/1998	9/23/1998				
LUST		LUST - Report Received	Completed	4/13/2006	4/13/2006				
LUST		LUST - Report Received	Completed	1/5/2006	1/5/2006				
LUST		LUST - Report Received	Completed	4/19/2005	4/19/2005				
LUST		LUST - Report Received	Completed	4/23/2007	4/23/2007				
LUST		LUST - Report Received	Completed	9/25/2001	9/25/2001				
LUST		LUST - Report Received	Completed	10/24/2003	10/24/2003				
LUST		LUST - Report Received	Completed	12/27/2001	12/27/2001				

LUST		LUST - Report Received	Completed	7/22/2008	7/22/2008				
LUST		LUST - Report Received	Completed	4/12/2001	4/12/2001				
LUST		LUST - Report Received	Completed	6/6/2002	6/6/2002				
LUST		LUST - Report Received	Completed	2/28/2002	2/28/2002				
LUST		LUST - Report Received	Completed	10/7/2004	10/7/2004				
LUST		LUST - Report Received	Completed	10/8/2002	10/8/2002				
LUST		LUST - Report Received	Completed	1/16/2004	1/16/2004				
LUST		LUST - Report Received	Completed	4/20/2004	4/20/2004				
LUST		LUST - Report Received	Completed	3/4/2008	3/4/2008				
LUST		LUST - Report Received	Completed	7/2/2003	7/2/2003				
LUST		LUST - Report Received	Completed	10/17/2006	10/17/2006				
LUST		LUST - Report Received	Completed	12/20/2007	12/20/2007				
LUST		LUST - Report Received	Completed	11/18/2008	11/18/2008				
LUST		LUST - Report Received	Completed	1/28/2005	1/28/2005				
LUST		LUST - Report Received	Completed	3/8/2013	3/8/2013				
VcpProject	NW2847	VCP Opinion on Site Cleanup	Completed	4/4/2014	6/30/2014				Sanchez, Maureen

AFFECTED MEDIA & CONTAMINANTS:

Media:

Contaminant:	Ground Water	Surface Water	Soil	Sediment	Air	Bedrock
Benzene	C		C			
Other Non-Halogenated Organics	C					
Petroleum-Gasoline	C		C			

Key:

B - Below Cleanup Level
C - Confirmed Above Cleanup Level
S - Suspected

R - Remediated
RA - Remediated-Above
RB - Remediated-Below

CleanupSiteDetails2014

KING COUNTY

SITE ID:	Renton Clinic Association	Cleanup Site ID: 11160	FS ID: 94731533
-----------------	----------------------------------	------------------------	-----------------

Alternate Name(s): RENTON CLINIC ASSOCIATION

LOCATION:	WRIA: 9	Lat/Long: 47.477 -122.216	View Vicinity Map
Address: 215 S 4TH PL KENT 98042-0000	Township: 23N	Range: 5E	Section: 18
	Legislative District: 11	Congressional District: 9	

STATUS:	Cleanup Started	Rank:	View Site Web Page	View Site Documents
Responsible Unit: Northwest	Site Manager: Northwest Region	Statute: MTCA		
Is Brownfield?	Has Environmental Covenant?	Is PSI Site?		
NFA Received?	NFA Date:	NFA Reason:		

ASSOCIATED CLEANUP UNIT(s)

culID	Cleanup Unit Name	Unit Type	Process Type	Unit Status	Size (Acres)	ERTS ID
10852	Renton Clinic Association	Upland	Independent Action	Cleanup Started		

SITE ACTIVITIES:

Applies to:	Related ID (Unit-LUST-VCP)	Activity Display Name	Status	Start Date	End Date	Legal Mechanism	Performed By	Project Manager
CleanupSite		Site Discovery/Release Report Received	Completed	3/1/1992	3/1/1992			Northwest Region
CleanupSite		Initial Investigation / Federal Preliminary Assessment	Completed	10/3/2011	10/3/2011		Ecology w/ Contractor	Olsen, Russ
CleanupSite		Early Notice Letter(s)	Completed	10/3/2011	10/3/2011			Olsen, Russ
LUST		LUST - Notification	Completed	3/1/1992	3/1/1992			
LUST		LUST - Report Received	Completed	4/23/1991	4/23/1991			
LUST		LUST - Report Received	Completed	5/31/1995	5/31/1995			

AFFECTED MEDIA & CONTAMINANTS:

Media:

Contaminant:	Ground Water	Surface Water	Soil	Sediment	Air	Bedrock
Petroleum-Other	C		C			

Key:

B - Below Cleanup Level
C - Confirmed Above Cleanup Level
S - Suspected

R - Remediated
RA - Remediated-Above
RB - Remediated-Below

CleanupSiteDetails2014

KING COUNTY

SITE ID:	Formula One Service	Cleanup Site ID: 11250	FS ID: 96572525
-----------------	----------------------------	------------------------	-----------------

Alternate Name(s): FORMULA ONE FORMER INDY LUBE, Formula One Service, INDY LUBE UST 6799

LOCATION:	WRIA: 9	Lat/Long: 47.483 -122.219	View Vicinity Map
Address:	100 RAINIER AVE S RENTON 98055-2044	Township: 23N Range: 5E Section: 18	Legislative District: 37 Congressional District: 9

STATUS:	Cleanup Started	Rank:	View Site Web Page	View Site Documents
	Responsible Unit: Northwest	Site Manager: Northwest Region	Statute: MTCA	
	Is Brownfield?	Has Environmental Covenant?	Is PSI Site?	
	NFA Received?	NFA Date:	NFA Reason:	

ASSOCIATED CLEANUP UNIT(s)

cuID	Cleanup Unit Name	Unit Type	Process Type	Unit Status	Size (Acres)	ERTS ID
10942	Formula One Service	Upland	Independent Action	Cleanup Started		

SITE ACTIVITIES:

Applies to:	Related ID (Unit-LUST-VCP)	Activity Display Name	Status	Start Date	End Date	Legal Mechanism	Performed By	Project Manager
CleanupSite		Site Discovery/Release Report Received	Completed	1/16/2000	1/16/2000			Northwest Region
LUST		LUST - Notification	Completed	1/6/2000	1/6/2000			Bails, John
LUST		LUST - Report Received	Completed	2/1/2000	2/1/2000			
LUST		LUST - Report Received	Completed	1/22/2001	1/22/2001			
LUST		LUST - Report Received	Completed	1/22/2001	1/22/2001			
LUST		LUST - Report Received	Completed	2/17/2000	2/17/2000			

AFFECTED MEDIA & CONTAMINANTS:

Media:

Contaminant:	Ground Water	Surface Water	Soil	Sediment	Air	Bedrock
Petroleum-Other	B		C			

Key:

B - Below Cleanup Level
C - Confirmed Above Cleanup Level
S - Suspected

R - Remediated
RA - Remediated-Above
RB - Remediated-Below

CleanupSiteDetails2014

KING COUNTY

SITE ID: **Qwest Corporation W00276** Cleanup Site ID: 11252 FS ID: 96588161

Alternate Name(s): QWEST CORP W00276, Qwest Corporation W00276, RENTON CO 070276, US WEST COMMUNICATION INC W00276, US WEST COMMUNICATIONS W00276, US West Renton Central Office

LOCATION: WRIA: 9 Lat/Long: 47.481 -122.207 [View Vicinity Map](#)

Address: 225 WILLIAMS AVE S Township Range Section Legislative District: 37
 RENTON 98055 23N 5E 17 Congressional District: 9

STATUS: **Cleanup Started** Rank: [View Site Web Page](#) [View Site Documents](#)

Responsible Unit: Northwest Site Manager: Northwest Region Statute: MTCA
 Is Brownfield? Has Environmental Covenant? Is PSI Site?
 NFA Received? NFA Date: NFA Reason:

ASSOCIATED CLEANUP UNIT(s)

culID	Cleanup Unit Name	Unit Type	Process Type	Unit Status	Size (Acres)	ERTS ID
10944	Qwest Corporation W00276	Upland	Independent Action	Cleanup Started		

SITE ACTIVITIES:

Applies to:	Related ID (Unit-LUST-VCP)	Activity Display Name	Status	Start Date	End Date	Legal Mechanism	Performed By	Project Manager
CleanupSite		Site Discovery/Release Report Received	Completed	10/3/1990	10/3/1990			Northwest Region
CleanupSite		Initial Investigation / Federal Preliminary Assessment	Completed	1/20/2009	1/20/2009		Ecology	Reid, Wallace
CleanupSite		Early Notice Letter(s)	Completed	7/13/2012	7/13/2012			Musa, Donna
LUST		LUST - Notification	Completed	10/3/1990	10/3/1990			
LUST		LUST - Report Received	Completed	7/3/1991	7/3/1991			
LUST		LUST - Report Received	Completed	11/20/1992	11/20/1992			
LUST		LUST - Report Received	Completed	3/19/1991	3/19/1991			
LUST		LUST - Report Received	Completed	9/20/1990	9/20/1990			

AFFECTED MEDIA & CONTAMINANTS:

Media:

Contaminant:	Ground Water	Surface Water	Soil	Sediment	Air	Bedrock
Petroleum-Other	C		C			

Key:

B - Below Cleanup Level
 C - Confirmed Above Cleanup Level
 S - Suspected

R - Remediated
 RA - Remediated-Above
 RB - Remediated-Below

CleanupSiteDetails2014

KING COUNTY

SITE ID: **Safeway Fuel Renton** Cleanup Site ID: 11352 FS ID: 99291269

Alternate Name(s): **SAFEWAY, SAFEWAY FUEL, Safeway Fuel Renton**

LOCATION: WRIA: 9 Lat/Long: 47.480 -122.216 [View Vicinity Map](#)

Address: 103 S 3RD ST RENTON 98055 Township 23N Range 5E Section 18 Legislative District: 37 Congressional District: 9

STATUS: **Cleanup Started** Rank: [View Site Web Page](#) [View Site Documents](#)

Responsible Unit: Northwest Site Manager: Northwest Region Statute: MTCA
 Is Brownfield? Has Environmental Covenant? Is PSI Site?
 NFA Received? NFA Date: NFA Reason:

ASSOCIATED CLEANUP UNIT(s)

culID	Cleanup Unit Name	Unit Type	Process Type	Unit Status	Size (Acres)	ERTS ID
11044	Safeway Fuel Renton	Upland	Independent Action	Cleanup Started		504228

SITE ACTIVITIES:

Applies to:	Related ID (Unit-LUST-VCP)	Activity Display Name	Status	Start Date	End Date	Legal Mechanism	Performed By	Project Manager
LUST		LUST - Notification	Completed	5/18/1999	5/18/1999			
LUST		LUST - Report Received	Completed	6/17/2011	6/17/2011			
LUST		LUST - Report Received	Completed	11/13/2006	11/13/2006			
LUST		LUST - Report Received	Completed	10/7/2002	10/7/2002			
LUST		LUST - Report Received	Completed	8/15/2002	8/15/2002			
LUST		LUST - Report Received	Completed	8/15/2002	8/15/2002			
LUST		LUST - Report Received	Completed	8/15/2002	8/15/2002			
LUST		LUST - Report Received	Completed	9/27/2004	9/27/2004			
LUST		LUST - Report Received	Completed	8/15/2002	8/15/2002			
LUST		LUST - Report Received	Completed	1/8/2003	1/8/2003			
LUST		LUST - Report Received	Completed	4/18/2003	4/18/2003			
LUST		LUST - Report Received	Completed	10/9/2007	10/9/2007			
LUST		LUST - Report Received	Completed	5/14/2009	5/14/2009			

LUST		LUST - Report Received	Completed	10/29/2003	10/29/2003				
LUST		LUST - Report Received	Completed	8/15/2002	8/15/2002				
LUST		LUST - Report Received	Completed	8/15/2002	8/15/2002				
LUST		LUST - Report Received	Completed	8/15/2002	8/15/2002				
LUST		LUST - Report Received	Completed	8/15/2002	8/15/2002				
LUST		LUST - Report Received	Completed	10/18/2005	10/18/2005				
LUST		LUST - Report Received	Completed	6/3/2005	6/3/2005				
LUST		LUST - Report Received	Completed	8/15/2002	8/15/2002				
LUST		LUST - Report Received	Completed	5/3/2004	5/3/2004				
LUST		LUST - Report Received	Completed	11/24/2009	11/24/2009				
LUST		LUST - Report Received	Completed	7/12/2002	7/12/2002				
LUST		LUST - Report Received	Completed	6/1/2010	6/1/2010				

AFFECTED MEDIA & CONTAMINANTS:

Media:

Contaminant:	Ground Water	Surface Water	Soil	Sediment	Air	Bedrock
Benzene	C		C			
Petroleum-Gasoline	C		C			

Key:

B - Below Cleanup Level
C - Confirmed Above Cleanup Level
S - Suspected

R - Remediated
RA - Remediated-Above
RB - Remediated-Below

CleanupSiteDetails2014

KING COUNTY

SITE ID: **Sunset Cars** Cleanup Site ID: 11937 FS ID: 5366

Alternate Name(s): Pierotti Property, Sunset Cars, Vacant Property (Pierotti), Vacant Property Pierotti

LOCATION: WRIA: 8 Lat/Long: 47.487 -122.194 [View Vicinity Map](#)

Address: 330 Sunset Blvd N Renton 98055 Township 23N Range 5E Section 17 Legislative District: 37 Congressional District: 9

STATUS: **Cleanup Started** Rank: [View Site Web Page](#) [View Site Documents](#)

Responsible Unit: Northwest Site Manager: Northwest Region Statute: MTCA

Is Brownfield? Has Environmental Covenant? Is PSI Site?

NFA Received? NFA Date: NFA Reason:

ASSOCIATED CLEANUP UNIT(s)

culID	Cleanup Unit Name	Unit Type	Process Type	Unit Status	Size (Acres)	ERTS ID
12544	SUNSET CARS	Upland	Independent Action	Cleanup Started		629998

SITE ACTIVITIES:

Applies to:	Related ID (Unit-LUST-VCP)	Activity Display Name	Status	Start Date	End Date	Legal Mechanism	Performed By	Project Manager
CleanupSite		Site Discovery/Release Report Received	Completed	10/26/2011	10/26/2011			Northwest Region
CleanupSite		Initial Investigation / Federal Preliminary Assessment	Completed	11/7/2011	11/7/2011		Ecology	Zouboulakis, Chris
CleanupSite		Early Notice Letter(s)	Completed	8/6/2012	8/6/2012			Musa, Donna
LUST		LUST - Notification	Completed	10/26/2011	10/26/2011			Northwest Region
LUST		LUST - Report Received	Completed	12/19/2012	12/19/2012			
LUST		LUST - Report Received	Completed	2/17/2012	2/17/2012			

AFFECTED MEDIA & CONTAMINANTS:

Media:

Contaminant:	Ground Water	Surface Water	Soil	Sediment	Air	Bedrock
Benzene			C			
Lead			C			
Petroleum-Diesel			C			
Petroleum-Gasoline			C			

Key:

B - Below Cleanup Level
C - Confirmed Above Cleanup Level
S - Suspected

R - Remediated
RA - Remediated-Above
RB - Remediated-Below

CleanupSiteDetails2014

KING COUNTY

SITE ID: **Dennys Restaurant** Cleanup Site ID: 12058 FS ID: 5970

Alternate Name(s): Denny's Restaurant, Dennys Restaurant, Dennys Restaurant Rainier Ave, RICHFIELD RAINIER SERVICE

LOCATION: WRIA: 9 Lat/Long: 47.482 -122.217 [View Vicinity Map](#)

Address: 144 RAINIER AVE S RENTON 98057 Township 23N Range 5E Section 18 Legislative District: 37 Congressional District: 9

STATUS: **Cleanup Started** Rank: [View Site Web Page](#) [View Site Documents](#)

Responsible Unit: Northwest Site Manager: Northwest Region Statute: MTCA

Is Brownfield? Has Environmental Covenant? Is PSI Site?

NFA Received? NFA Date: NFA Reason:

ASSOCIATED CLEANUP UNIT(s)

culID	Cleanup Unit Name	Unit Type	Process Type	Unit Status	Size (Acres)	ERTS ID
12673	Denny's Restaurant	Upland	Voluntary Cleanup Program	Cleanup Started		

SITE ACTIVITIES:

Applies to:	Related ID (Unit-LUST-VCP)	Activity Display Name	Status	Start Date	End Date	Legal Mechanism	Performed By	Project Manager
LUST		LUST - Notification	Completed	12/31/2012	12/31/2012			Northwest Region
LUST		LUST - Report Received	Completed	12/31/2012	12/31/2012			
LUST		LUST - Report Received	Completed	12/31/2012	12/31/2012			
LUST		LUST - Report Received	Completed	12/31/2012	12/31/2012			
LUST		LUST - Report Received	Completed	8/9/2013	8/9/2013			
VcpProject	NW2677	VCP Receipt of Plan or Report	Completed	12/31/2012	12/31/2012			Pederson, Carrie
VcpProject	NW2677	VCP Receipt of Plan or Report	Completed	12/31/2012	12/31/2012			Pederson, Carrie
VcpProject	NW2677	VCP Receipt of Plan or Report	Completed	12/31/2012	12/31/2012			Pederson, Carrie
VcpProject	NW2677	VCP Opinion on Site Cleanup	Completed	1/15/2013	4/17/2013			Yang, Grant
VcpProject	NW2677	VCP Status Request	Completed	8/9/2016	1/6/2017			Yang, Grant

AFFECTED MEDIA & CONTAMINANTS:

Media:

Contaminant:	Ground Water	Surface Water	Soil	Sediment	Air	Bedrock
Benzene	C		C			

Key:

B - Below Cleanup Level
 C - Confirmed Above Cleanup Level
 S - Suspected
 R - Remediated
 RA - Remediated-Above
 RB - Remediated-Below

Petroleum-Gasoline

C

C

CleanupSiteDetails2014

KING COUNTY

SITE ID:	Tire Store	Cleanup Site ID: 12364	FS ID: 24009
-----------------	-------------------	------------------------	--------------

Alternate Name(s): Tire Store

LOCATION:	WRIA: 9	Lat/Long: 47.481 -122.210	View Vicinity Map
Address:	205 LOGAN AVE S RENTON 98057	Township: 23N Range: 5E Section: 18	Legislative District: 37 Congressional District: 9

STATUS:	Cleanup Started	Rank:	View Site Web Page	View Site Documents
	Responsible Unit: Northwest	Site Manager: Northwest Region	Statute: MTCA	
	Is Brownfield?	Has Environmental Covenant?	Is PSI Site?	
	NFA Received?	NFA Date:	NFA Reason:	

ASSOCIATED CLEANUP UNIT(s)

culID	Cleanup Unit Name	Unit Type	Process Type	Unit Status	Size (Acres)	ERTS ID
13001	Tire Store	Upland	Independent Action	Cleanup Started		641368

SITE ACTIVITIES:

Applies to:	Related ID (Unit-LUST-VCP)	Activity Display Name	Status	Start Date	End Date	Legal Mechanism	Performed By	Project Manager
CleanupSite		Site Discovery/Release Report Received	Completed	5/20/2013	5/20/2013			Musa, Donna
CleanupSite		Initial Investigation / Federal Preliminary Assessment	Completed	10/22/2013	10/22/2013		Ecology	Musa, Donna
CleanupSite		Early Notice Letter(s)	Completed	5/28/2014	5/28/2014			Musa, Donna

AFFECTED MEDIA & CONTAMINANTS:

Media:

Contaminant:	Ground Water	Surface Water	Soil	Sediment	Air	Bedrock
Petroleum-Diesel			C			
Petroleum-Other			C			

Key:

B - Below Cleanup Level
 C - Confirmed Above Cleanup Level
 S - Suspected
 R - Remediated
 RA - Remediated-Above
 RB - Remediated-Below

KING COUNTY

SITE ID:	Cedar River Court Apartments	Cleanup Site ID: 13142	FS ID: 12793
-----------------	-------------------------------------	------------------------	--------------

Alternate Name(s): Cedar River Court Apartments

LOCATION:	WRIA: 8	Lat/Long: 47.482 -122.204	View Vicinity Map
Address: 130 MAIN AVE S RENTON 98057	Township: 23N	Range: 5E	Section: 17
	Legislative District: 37	Congressional District: 9	

STATUS:	Cleanup Started	Rank:	View Site Web Page	View Site Documents
Responsible Unit: Headquarters	Site Manager: Maurer, Christopher	Statute: MTCA		
Is Brownfield?	Has Environmental Covenant?	Is PSI Site?		
NFA Received?	NFA Date:	NFA Reason:		

ASSOCIATED CLEANUP UNIT(s)

culID	Cleanup Unit Name	Unit Type	Process Type	Unit Status	Size (Acres)	ERTS ID
13836	Cedar River Court Apartments	Upland	Voluntary Cleanup Program	Cleanup Started		

SITE ACTIVITIES:

Applies to:	Related ID (Unit-LUST-VCP)	Activity Display Name	Status	Start Date	End Date	Legal Mechanism	Performed By	Project Manager
VcpProject	NW3089	VCP Receipt of Plan or Report	Completed	9/2/2016	9/2/2016			Fernandez, Sonia
VcpProject	NW3089	VCP Receipt of Plan or Report	Completed	10/11/2016	10/11/2016			Fernandez, Sonia
VcpProject	NW3089	VCP Receipt of Plan or Report	Completed	9/2/2016	9/2/2016			Fernandez, Sonia
VcpProject	NW3089	VCP Receipt of Plan or Report	Completed	9/2/2016	9/2/2016			Fernandez, Sonia
VcpProject	NW3089	VCP Opinion on Site Cleanup	In Process	9/2/2016				Maurer, Christopher

AFFECTED MEDIA & CONTAMINANTS:

Media:

Contaminant:	Ground Water	Surface Water	Soil	Sediment	Air	Bedrock
Petroleum-Other			C			

Key:

B - Below Cleanup Level
C - Confirmed Above Cleanup Level
S - Suspected

R - Remediated
RA - Remediated-Above
RB - Remediated-Below

CleanupSiteDetails2014

KING COUNTY

SITE ID:	Panther Lake Shopping Center	Cleanup Site ID: 13256	FS ID: 17428
-----------------	-------------------------------------	------------------------	--------------

Alternate Name(s): Panther Lake Shopping Center

LOCATION:	WRIA: 9	Lat/Long: 47.416 -122.196	View Vicinity Map
Address:	20610 108TH AVE SE KENT 98031	Township: 22N Range: 5E Section: 5	Legislative District: 11 Congressional District: 9

STATUS:	Cleanup Started	Rank:	View Site Web Page	View Site Documents
	Responsible Unit: Headquarters	Site Manager: Maurer, Christopher	Statute: MTCA	
	Is Brownfield?	Has Environmental Covenant?	Is PSI Site?	
	NFA Received?	NFA Date:	NFA Reason:	

ASSOCIATED CLEANUP UNIT(s)

culID	Cleanup Unit Name	Unit Type	Process Type	Unit Status	Size (Acres)	ERTS ID
13966	Panther Lake Shopping Center	Upland	Voluntary Cleanup Program	Cleanup Started		

SITE ACTIVITIES:

Applies to:	Related ID (Unit-LUST-VCP)	Activity Display Name	Status	Start Date	End Date	Legal Mechanism	Performed By	Project Manager
CleanupSite		Site Discovery/Release Report Received	Completed	3/21/2017	3/21/2017			Fernandez, Sonia
VcpProject	NW3124	VCP Receipt of Plan or Report	Completed	2/14/2017	2/14/2017			Fernandez, Sonia
VcpProject	NW3124	VCP Receipt of Plan or Report	Completed	2/14/2017	2/14/2017			Fernandez, Sonia
VcpProject	NW3124	VCP Receipt of Plan or Report	Completed	2/14/2017	2/14/2017			Fernandez, Sonia
VcpProject	NW3124	VCP Opinion on Remedial Investigation	In Process	3/21/2017				Northwest Region

AFFECTED MEDIA & CONTAMINANTS:

Media:

Contaminant:	Ground Water	Surface Water	Soil	Sediment	Air	Bedrock
Halogenated Solvents			C			

Key:

B - Below Cleanup Level
C - Confirmed Above Cleanup Level
S - Suspected

R - Remediated
RA - Remediated-Above
RB - Remediated-Below

CleanupSiteDetails2014

APPENDIX D
NOTIFICATION LETTERS

DATE

Address of local business or cleanup site (see Table 2 and Table D-1)

Re: City of Renton Aquifer Protection Program

To Whom It May Concern:

The City of Renton has developed an updated Aquifer Protection Program Plan to help maintain drinking water quality for our city residents. The Plan is based on Washington Department of Health WAC 246-290-135(3) regulations. As part of the Plan, maps were prepared that show the areas around each city drinking water source where a chemical spill on the ground may cause contamination of the aquifer. These areas are Aquifer Protection Areas (APAs). The Plan also requires an inventory of potential sources of groundwater contamination within these APAs.

The primary purpose of this letter is to notify you that your facility is located within one of our APAs. Since your business or the activities conducted at your facility may involve the use of chemicals (e.g., gasoline, underground storage tanks, hazardous materials, etc.), and the potential exists that a chemical spill from your facility may adversely impact the City drinking water supply, please notify the City of Renton immediately if a chemical spill occurs at your facility. All spills should be reported by dialing 911 and requesting that the City of Renton Fire Department and that Public Health Department for Seattle & King County be contacted.

Thank you for assisting us in protecting our water supply and groundwater resources. If you have any questions, please contact me at (425) 430-7335.

Sincerely,

Katie Nolan
Drinking Water Utility Civil Engineer
City of Renton

Table D-1. WHPA Notification Mailing List for Active Sites of Potential Concern

Map ID	Facility Name	Facility ID	Address	City	State	Zip Code
1	RENTON CITY CCTF	9776647	1715 SE MAPLE VALLEY HWY	RENTON	WA	98055-3900
2	RENTON CITY WELL 9	43699751	1707 SE MAPLE VALLEY HWY	RENTON	WA	98055-3900
3	Shag Cedar River Court Apartments (Cedar River Court Apartments)	12793	130 MAIN AVE S	RENTON	WA	98057
4	RENTON CITY WELL 8	32747884	1703 SE MAPLE VALLEY HWY	RENTON	WA	98055-3900
5	RENTON CITY WELL 1 2 3	65475594	1398 HOUSER WAY N	RENTON	WA	98056
6	Vacant (Tire Store)	24009	205 LOGAN AVE S	RENTON	WA	98057
7	Pacific NW Bell Switching Station / CenturyLink (Qwest Corporation W00276)	96588161	225 WILLIAMS AVE S	RENTON	WA	98055
8	Stoneway Concrete Renton	62244377	1915 SE MAPLE VALLEY HWY	RENTON	WA	98055
9	ABRA Auto Body & Glass (Taylors Auto Body)	54887792	330 MAIN AVE S	RENTON	WA	98057
10	North American Refractories	82472985	1500 HOUSER WAY S	RENTON	WA	98055-1566
11	SERVICE LINEN SUPPLY INC	12593698	903 S 4TH ST	RENTON	WA	98057-0659
12	Shell (Arco 5207)	17426998	401 PARK AVE N	RENTON	WA	98055
13	Renton School Dist 403	2066	1220 N 4TH ST	RENTON	WA	98055
14	Kennys Auto Rebuild Inc	46848442	618 Park Ave N	Renton	WA	98057
15	RENTON SOC 070728	77423621	549 GARDEN	RENTON	WA	98055-1511
16	PACCAR PARTS NW DISTRIBUTING	82882955	502 HOUSER WAY N	RENTON	WA	98055-1504
17	Kenworth Truck Research & Development	5276518	485 HOUSER WAY N	RENTON	WA	98055
18	PACCAR MIS	85953633	480 HOUSER WAY N	RENTON	WA	98057
19	PACIFIC CAR & FOUNDRY CO	2065	1400 N 4TH ST	RENTON	WA	98057
20	Boeing 5th & Park Building	85524291	500 PARK AVE N GARAGE BLDG 1013 & 1016	RENTON	WA	98055
21	Kelly Moore Paint Co Inc Renton	2509959	350 Sunset Blvd N Ste C	Renton	WA	98057
22	Spirit Auto Center of Renton (Sunset Cars; Vacant Property (Pierotti))	5366	330 Sunset Blvd N	Renton	WA	98055
23	Ero-Dyne Aviation (SKY HARBOR AVIATION)	63051958	300 AIRPORT WAY S	RENTON	WA	98055
24	Renton Airport	15436	243 Perimeter Rd W	RENTON	WA	98057
25	Vacant (SDS Partners)	63618514	307 AIRPORT WAY	RENTON	WA	98057
26	Gudmundson Co Inc	62661325	102 LAKE AVE S	RENTON	WA	98055
27	Formula-1 Fast Lube (INDY LUBE UST 6799; Formula One Service)	96572525	100 RAINIER AVE S	RENTON	WA	98055-2044
28	Vacant (Dennys Restaurant Rainier Ave)	5970	144 RAINIER AVE S	RENTON	WA	98057
29	Gene Meyer Inc	44381644	225 RAINIER AVE S	RENTON	WA	98055
30	SUNSET RAINIER RENTON WALGREENS	88647696	299 RAINIER AVE S	RENTON	WA	98055
31	Safeway Store 1563	5763	200 S 3rd St	Renton	WA	98055
32	Hertz and Lyft Express Drive (Walkers Renton Subaru Used Cars)	19684856	250 RAINIER AVE S	RENTON	WA	98057
33	SAFEWAY STORE 1563 FUEL CENTER	2859817	200 S 3RD ST STE A	RENTON	WA	98055
34	SAFEWAY Fuel Renton	99291269	103 S 3RD ST	RENTON	WA	98055
35	RENTON BP	16258354	300 320 RAINIER AVE S	RENTON	WA	98055
36	Renton Cleaning Center	5888526	364 RENTON CTR WAY SW	RENTON	WA	98055
37	Fred Meyer Fuel Center No. 459	20819	405/431 Rainier Avenue South	Renton	WA	98057
38	Verizon Wireless Renton Center	2302487	450 SHATTUCK AVE S	RENTON	WA	98055
39	Latin Market (Renton Clinic Assoc)	94731533	215 S 4TH PL	KENT	WA	98042-0000
40	Salon de Belleza (Scott Drycleaners)	62912812	201 S 4TH PL	RENTON	WA	98055
41	BURNETT PARK	9006005	502 BURNETT AVE S	RENTON	WA	98055
42	Car Pros Chrysler Jeep Dodge Ram (Lithia Dodge Chrysler Jeep)	7826317	585 RAINIER AVE S	RENTON	WA	98055
43	Brown Bear (RENTON 1, Brown Bear Car Wash 2422)	27778869	621 & 641 RAINIER AVE S	RENTON	WA	98055-2410
44	PSE GRADY WAY RENTON COMPLEX PARCEL 3	86541135	915 S GRADY WAY	RENTON	WA	98055
45	Renton Coil Spring Co. (LTS Trucking, Castagno Brothers)	71914167	423 S 7TH ST	RENTON	WA	98055
46	BROWN BEAR CAR WASH	99851765	800 GRADY WAY S	RENTON	WA	98055-2943
47	Bankers Auto Rebuild & Towing	18577466	405 S 7TH ST	RENTON	WA	98055
48	Arco 5902	47138342	710 S GRADY WAY	RENTON	WA	98055
49	PSE GRADY WAY RENTON COMPLEX PARCEL 2	21349929	915 S GRADY WAY	RENTON	WA	98055
50	Kenworth Truck R&D	9167239	790 GARDEN AVE N	RENTON	WA	98055
51	PSE Boeing Renton #2 Substation	13138	704 Logan Ave N	Renton	WA	98057
52	KENWORTH TRUCK CO RENTON	13289817	1601 N 8TH ST	RENTON	WA	98057
53	Car Wash Enterprises CWE Renton	4474679	77 RAINIER AVE S	RENTON	WA	98055
54	King Cnty Solid Waste Div Renton Tran	62379615	3021 NE 4TH ST	RENTON	WA	98056

Table D-1. WHPA Notification Mailing List for Active Sites of Potential Concern

Map ID	Facility Name	Facility ID	Address	City	State	Zip Code
55	King County Dept of Transportation - 155 Monroe Ave NE	21295	Renton Transfer Station	Renton	WA	
56	KING CNTY DPW RENTON FACILITY	32954817	155 MONROE AVE NE	RENTON	WA	98056-4101
57	KING CO REGIONAL COMM AND EMERGENCY COORD CTR	24298	3511 NE 2ND ST	RENTON	WA	98056
58	Fred Meyer Stores Inc Renton	12107	365 Renton Center Way SW	Renton	WA	98057
59	Fred Meyer UST 7842 (SEARS ROEBUCK & CO UST 7842)	60178828	359 RENTON CENTER WAY SW	RENTON	WA	98055-2393
60	Wal Mart 2516	37352136	743 RAINIER AVE S	RENTON	WA	98055
61	Vacant (Sound Ford)	58499353	750 RAINIER AVE S	RENTON	WA	98055
62	Mini Mart/ Mobil Gas Station (USA MINI MART 115)	94569877	765 RAINIER AVE S	RENTON	WA	98055
63	Texaco Station 632320402	3238112	509 S GRADY WAY	RENTON	WA	98055
64	Walkers Renton MAZDA	18869255	200 S GRADY WAY	RENTON	WA	98055
65	CHEVRON 99114	77287947	301 S GRADY WAY	RENTON	WA	98055
66	Renton Village Cleaners (Renton Village Dry Cleaners)	4484368	601 S Grady Way	Renton	WA	98057
67	Rite Aid #5201	20396	601 S Grady Way Ste P	Renton	WA	98057
68	Allied Battery Co Inc Renton	5884609	55 SW 12TH	RENTON	WA	98108
69	AIRTOUCH CELLULAR SOUTH CENTER	71676937	15 S GRADY WAY	RENTON	WA	98055
70	Puhich Dry Cleaners	5971	319 Main Ave S	Renton	WA	98057
71	MAPLEWOOD MAINTENANCE SHOP	64293294	4000 MAPLE VALLEY HWY	RENTON	WA	98058-2871
72	RENTON CITY WATER DEPT	75784645	4030 MAPLE VALLEY HWY	RENTON	WA	98058-2874
73	VERIZON WIRELESS WARE MAPLEWOOD	19828	15214 149TH AVE SE	RENTON	WA	98058
74	KING COUNTY PARKS	34837919	3005 NE 4TH	RENTON	WA	98056
75	RENTON HIGHLANDS LANDFILL	2128	NE 3RD ST & NE 4TH ST	RENTON	WA	98056
76	King Cnty DOT Road Services Div	41149477	155 MONROE AVE NE BLDG P G F	RENTON	WA	98056-4199
77	FAIRWOOD GOLF & COUNTRY CLUB	43989944	17124 151TH AVE SE	RENTON	WA	98058-8508
78	RENTON CITY SPRING BROOK SPRINGS	76461781	5750 TALBOT RD S	RENTON	WA	98056
79	Panther Lake Shopping Center	17428	20610 108TH AVE SE	KENT	WA	98031
80	Rite Aid #5189	7155	20518 108th Ave SE	Kent	WA	98031
81	Allied Waste Service Kent	1247957	12403 SE 202ND PL	KENT	WA	98031
82	SOOS CREEK WATER & SEWER DISTRICT	24788111	12700 SE 198TH ST	RENTON	WA	98058-1039
83	Kennydale Chevron	74465899	1419 N 30TH ST	RENTON	WA	98056
84	KENNYDALE FUEL	3538	1616 NE 30TH ST	RENTON	WA	98056
85	Shell Station 120646	48271835	1410 N 30TH ST	RENTON	WA	98056

Notes:

Facility names in parentheses indicates that a site was visited during the windshield survey and it has a different name from the FSID facility name (which is in parentheses). Facility names with no parentheses in their entry use the FSID facility name.

DATE

Department of Ecology
Northwest Regional Office
3190 160th Ave SE
Bellevue, WA 98008-5452

Re: City of Renton Wellhead Protection Plan

Dear Department of Ecology:

The City of Renton has developed a Wellhead Protection Plan (which is referred to as the Aquifer Protection Program Plan in City materials) to help maintain the drinking water quality for our city residents. The Plan is based on Washington Department of Health WAC 246-290-135(3) regulations. As part of the Plan, maps were prepared that show the areas around each city drinking water source where a chemical spill on the ground may cause contamination of the aquifer. These areas are Wellhead Protection Areas (WHPAs).

The enclosed map depicts the WHPA boundary, source wells, and identified potential contaminant sources. Also enclosed is a table (Table D-1) providing the facility ID, name and location for each potential contaminant source. Please review the map and use it as a reference when inspecting and permitting the storage, use, and disposal of hazardous material within our WHPAs.

Please note that the City of Renton has sent notices to each of these properties informing them of their location within the WHPA boundary. The City has also sent similar letters to businesses with land uses that could potentially contaminate groundwater quality.

Thank you for your attention in this matter. If you have any questions or would like a copy of the wellhead protection plan, please contact me at (425) 430-7335.

Sincerely,

Katie Nolan
Drinking Water Utility Civil Engineer
City of Renton

DATE

Police Chief VanValey
Renton Police Department
1055 South Grady Way
Renton, Washington 98057

Re: City of Renton Aquifer Protection Plan

Dear Chief VanValey:

The City of Renton has developed an updated Aquifer Protection Program Plan to help maintain the drinking water quality for our city residents. The Plan is based on Washington Department of Health WAC 246-290-135(3) regulations. As part of the Plan, maps were prepared that show the areas around each city drinking water source where a chemical spill on the ground may cause contamination of the aquifer. These areas are Aquifer Protection Areas (APAs).

As part of this Plan, the city must provide wellhead protection information to agencies responsible for incident/spill response procedures. It is important that you are aware of where potential contaminant releases could adversely impact the quality of our community's drinking water supply.

A map of the APAs and adjacent transportation routes is enclosed for your review. An acknowledgement of receipt of this information or a response from your office as part of our aquifer protection plan documentation would be appreciated.

We ask that you review the enclosed copy of the City's current spill response plan so appropriate procedures are followed and necessary coordination occurs in the event of a spill or contaminant release.

Thank you for your attention in this matter. If you have any questions or would like a copy of the aquifer protection plan, please contact me at (425) 430-7335.

Sincerely,

Katie Nolan
Drinking Water Utility Civil Engineer
City of Renton

DATE

Renton Regional Fire Authority
1055 S Grady Way
7th Floor
Renton, Washington 98057

Re: City of Renton Aquifer Protection Plan

Dear Renton Regional Fire Authority Commissioners:

The City of Renton has developed an updated Aquifer Protection Program Plan to help maintain the drinking water quality for our city residents. The Plan is based on Washington Department of Health WAC 246-290-135(3) regulations. As part of the Plan, maps were prepared that show the areas around each city drinking water source where a chemical spill on the ground may cause contamination of the aquifer. These areas are Aquifer Protection Areas (APAs).

As part of this Plan, the City must provide wellhead protection information to agencies responsible for incident/spill response procedures. It is important that you are aware of where potential contaminant releases could adversely impact the quality of our community's drinking water supply.

A map of the APAs and adjacent transportation routes is enclosed for your review. An acknowledgement of receipt of this information or a response from your office as part of our wellhead protection plan documentation would be appreciated.

We ask that you review the enclosed copy of the City's current spill response plan so appropriate procedures are followed and necessary coordination occurs in the event of a spill or contaminant release.

Thank you for your attention in this matter. If you have any questions or would like a copy of the wellhead protection plan, please contact me at (425) 430-7335.

Sincerely,

Katie Nolan
Drinking Water Utility Civil Engineer
City of Renton

Appendix L-2
WELLHEAD PROTECTION AREAS AND SEPTIC
SYSTEMS MAP

Appendix M

WATER RECLAMATION EVALUATION CHECKLIST



King County

Water Reclamation Evaluation Checklist For Systems with 1,000 or more Connections

The County and State recognize that changing conditions could initiate a need to respond in new ways to future water quality standards, wastewater discharge requirements, take advantage of advances in treatment technologies and/or allow our region to be positioned to respond to changes associated with climate change and population growth.

In 2003, Chapter 90.46 of the Revised Code of Washington (RCW) was amended to require public water systems serving 1,000 or more connections to evaluate opportunities for reclaimed water when completing their water system plans. Please use this checklist to meet King County consistency requirements in responding to this legislation.

Water System Name: _____
Date: _____
PWS ID# _____
Contact: _____ knolan@rentonwa.gov

Please use this checklist, including the inventory template, to ensure that your water system plan includes sufficient information about opportunities for reclaimed water and your system's efforts to develop those opportunities. If a question is not applicable or the information is unavailable, then answer, "unknown" or "n/a." King County will consider the checklist completed if each answer is filled in with the best available information, even if the utility states that it is not aware of any reclaimed water opportunities within its service area.

1. Identifying Potential Future Demand for Reclaimed Water: King County maintains a database and map of potential reclaimed water users for evaluating future projects. Please use the template below, or similar table, to provide information to assist King County in further researching these potential uses.

• **Large Utility Water Users** (choose one):

- Attached is an inventory of twenty large (above 20,000 gallons/month on average), non single-family residential, water users served by our utility that have a potential for reclaimed water use, or
- Attached is an inventory of our utility's top twenty water users, or
- The information requested is unknown or not available.

Additional Comments: _____

• **Large Self Suppliers** (choose one):

- Attached is an inventory of large, self-supplied water users within our water utility's service boundaries - especially those near wastewater treatment plants, mainlines, outfalls, and pump stations or similar reclaimed water facilities), or
- The information requested is unknown or not available.

Additional Comments: _____

• **Other** (choose one):

- Attached is an inventory of other water users (such as those that are clustered near one another and could be served by a single system) that may be likely candidates for reclaimed water use, or
- The information requested is unknown or not available.

Additional Comments: _____

Other potential candidates are located in the Commercial/Industrial area located south of KC Reclaimed Water Facility (South Plant). We can provide electronic files of meter locations and associated consumption.

2. **Environmental Commitment:** Are you a city/town, or providing water service to a city/town, that has made commitments within resource management plans, salmon recovery plans, or other environmental initiatives for which there is a potential opportunity for using reclaimed water to assist in meeting commitments? (choose one)

Yes, here are plans that have potential for reclaimed water use in our service area to meet the above commitments:

The information requested is unknown, not available.

Additional Comments: _____

3. **Identifying Areas of Potential Use of Reclaimed Water for Environmental Benefit:**

Below are *examples* of uses of reclaimed water **that comply with State, Federal and other reclaimed water environmental, health and safety standards**. All of these uses are currently in effect somewhere in Washington State. To the best of your knowledge, are any of these potential uses for reclaimed water applicable to your area?

River Augmentation (choose one):

Yes, our water rights are limited by instream flows. For more information, King County may contact:

The information requested is unknown, or not available.

Additional Comments: _____

Groundwater Recharge (choose one):

Yes, we withdraw water from an aquifer that is in a groundwater management area, or from a declining aquifer, where water levels may need to be replenished or to maintain aquifer storage. For more information, King County may contact:

The information requested is unknown, or not available.

Additional Comments: _____

Water Rights Mitigation (choose one):

Yes, our area is pursuing, or planning to pursue, new or additional water rights, and there may be an opportunity to use reclaimed water for mitigation of those new water rights. For more information, King County may contact:

The information requested is unknown, or not available.

Additional Comments: _____

Potential Areas of Environmental Need (choose one):

Yes, parts of our service area include potential environmental enhancement locations, such as wetlands enhancement, aquifer recharge, stream flow augmentation, that might be candidates for reclaimed water use. For more information, King County may contact:

The information requested is unknown, or not available.

Additional Comments: _____

Appendix N
APPROVED GRINDER PUMP STATIONS FOR
SINGLE FAMILY RESIDENCES

City of Renton

Wastewater Utility

**Approved Private Grinder Pump
Stations
and Force Mains
for
Single Family Residences**

The following grinder pump package systems are approved by the City of Renton's Wastewater Utility for use in single family residences. Any grinder pump packages, other than those listed below, shall be submitted to the Wastewater Utility for review and approval prior to installation.

<u>Manufacturer</u>	<u>Grinder Package System</u>	<u>Local Contacts</u>
• E/ONE EXTREME	DH Series	Correct Equipment 425-869-1233
• Liberty Pumps	2400-Series	Gordon & Assoc. 425-228-5555
• Barnes	EcoTRAN System	H.D. Fowler Co. 425-654-8800

Installation of a grinder pump package shall be outside of the building footprint, within 5 feet of the foundation and per the manufactures guidelines.

All grinder pump package stations shall be hard-wired into the buildings electrical system. Electrical connections via a plug into an electrical outlet are not approved.

All grinder pump package stations shall have a minimum storage capacity of 50 gallons.

Private force mains shall be 1.25-inch or 1.5-inch nominal diameter SDR 21 PVC, Schedule 40 PVC (200 psi), SDR 11 HDPE poly pipe or other approved material.

Private force mains with pipe joints shall be tested at 150 psi in accordance with ASTM F2164, "Standard Practice for Field Leak Testing of Polyethylene (PE) Pressure Piping Systems Using Hydrostatic Pressure". A test will be considered a failure if the pressure drops by more than 5 psi in 1 hours.

Private Force Main Pressure Testing Procedure

1. Fill line slowly with water.
2. Expel air from system during filling and before applying test pressure.
3. Apply test pressure and allow system to stand without makeup pressure for 2 to 3 hours to allow for expansion of pipe.
4. Apply specified test pressure for 1 hours.
5. Pressure test shall be witnessed by a City of Renton representative.

E/ONE EXTREME

DH071/DR071

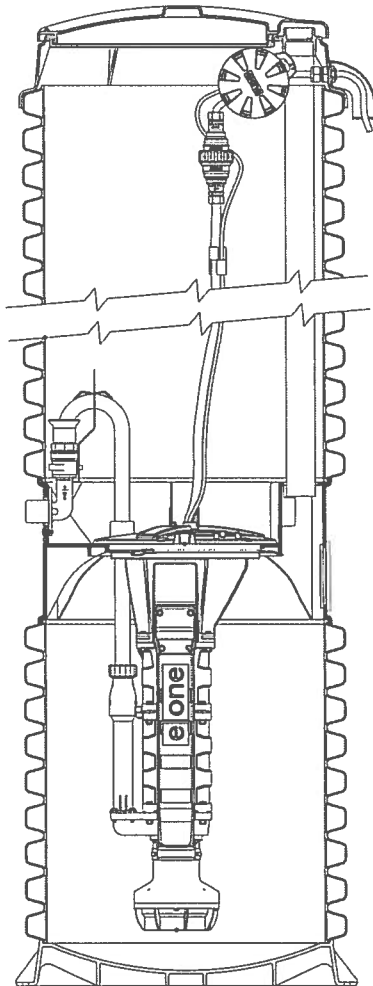

General Features

The model DH071 or DR071 grinder pump station is a complete unit that includes: the grinder pump, check valve, HDPE (high density polyethylene) tank, controls, and alarm panel. A single DH071 or DR071 is a popular choice for one, average single-family home and can also be used for up to two average single-family homes where codes allow and with consent of the factory.

- Rated for flows of 700 gpd (2650 lpd)
- 70 gallons (265 liters) of capacity
- Indoor or outdoor installation
- Standard outdoor heights range from 61 inches to 160 inches

The DH071 is the “hardwired,” or “wired,” model where a cable connects the motor controls to the level controls through watertight penetrations.

The DR071 is the “radio frequency identification” (RFID), or “wireless,” model that uses wireless technology to communicate between the level controls and the motor controls.

Operational Information

Motor

1 hp, 1,725 rpm, high torque, capacitor start, thermally protected, 120/240V, 60 Hz, 1 phase

Inlet Connections

4-inch inlet grommet standard for DWV pipe. Other inlet configurations available from the factory.

Discharge Connections

Pump discharge terminates in 1.25-inch NPT female thread. Can easily be adapted to 1.25-inch PVC pipe or any other material required by local codes.

Discharge

15 gpm at 0 psig (0.95 lps at 0 m)
11 gpm at 40 psig (0.69 lps at 28 m)
7.8 gpm at 80 psig (0.49 lps at 56 m)

Accessories

E/One requires that the Uni-Lateral, E/One’s own stainless steel check valve, be installed between the grinder pump station and the street main for added protection against backflow.

Alarm panels are available with a variety of options, from basic monitoring to advanced notice of service requirements.

The Remote Sentry is ideal for installations where the alarm panel may be hidden from view.

Patent Numbers: 5,752,315
5,562,254 5,439,180

NA0050P01 Rev C

OPTIONS : **DH071** (HARD WIRED LEVEL CONTROLS)

DR071 (WIRELESS LEVEL CONTROLS)

FIELD JOINT REQUIRED FOR MODELS
DH071-129 / DR071-129
&
DH071-160 / DR071-160

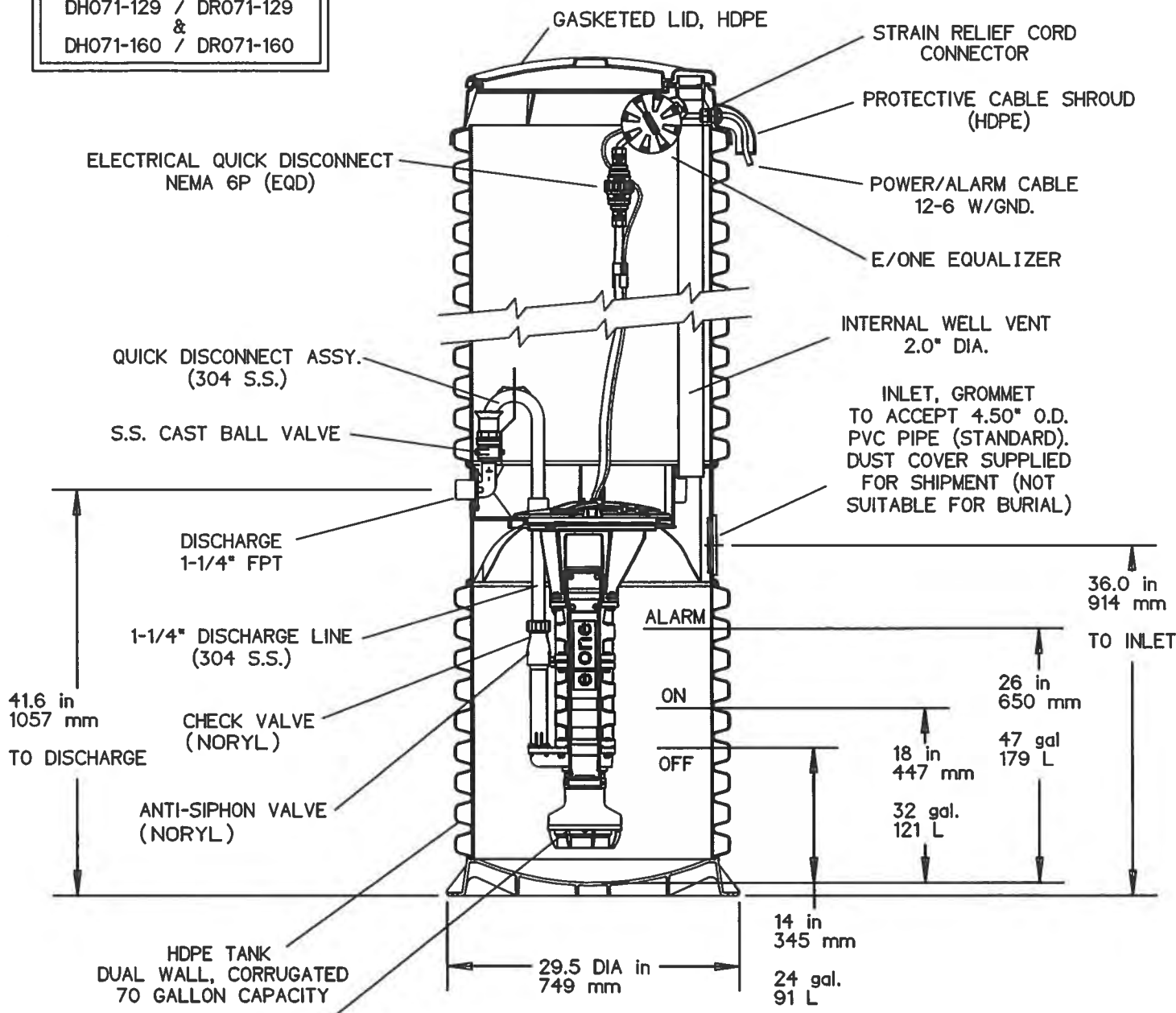

SEMI-POSITIVE DISPLACEMENT TYPE PUMP. EACH DIRECTLY DRIVEN BY A 1 HP MOTOR



CONCRETE BALLAST MAY BE REQUIRED SEE INSTALLATION INSTRUCTION FOR DETAILS

NOTE: DIMENSIONS ARE FOR REF ONLY

AD	CH	10/20/10	D	
DR BY	CHK'D	DATE	ISSUE	SCALE
MODEL DH071 / DR071 DETAIL SHEET				
NA0050P02				

OPTIONS : **DH071-61** (HARD WIRED LEVEL CONTROLS)
 DR071-61 (WIRELESS LEVEL CONTROLS)

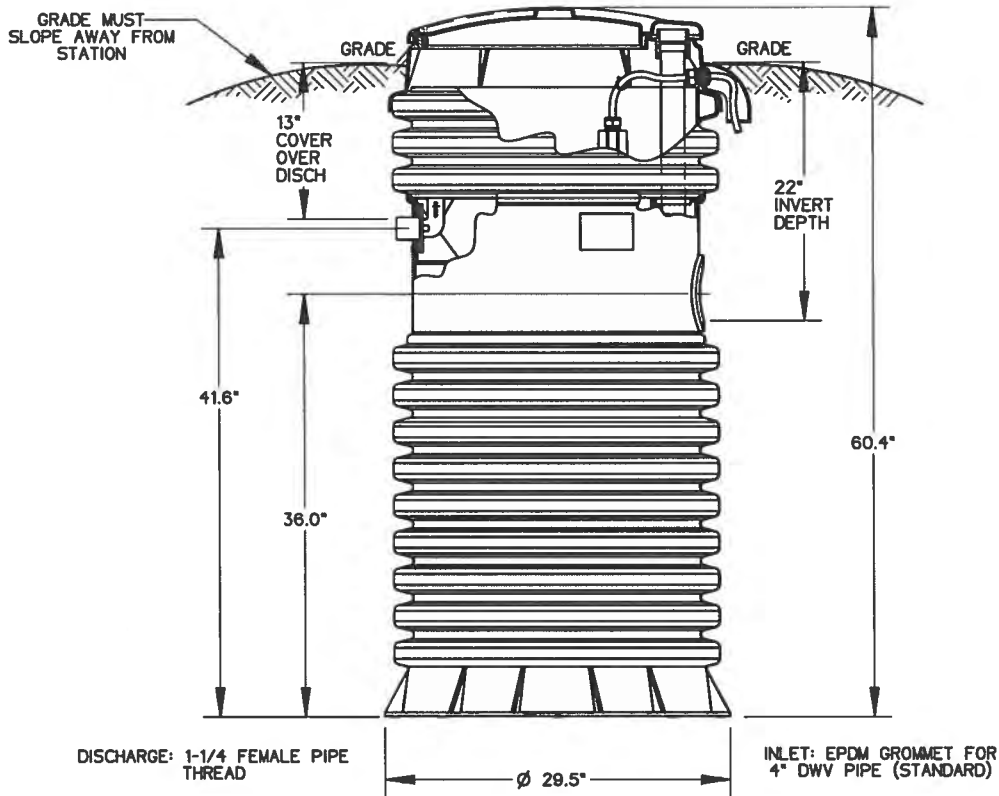

CONCRETE BALLAST MAY BE REQUIRED
 SEE INSTALLATION INSTRUCTIONS
 FOR DETAILS

NOTE: DIMENSIONS ARE FOR REF ONLY



AD	CAH	07/12/07	B	1/16
DR BY	CHK'D	DATE	ISSUE	SCALE
MODEL DH071-61 / DR071-61				
NA0050P04				

OPTIONS : **DH071-74**

(HARD WIRED
LEVEL CONTROLS)

DR071-74

(WIRELESS
LEVEL CONTROLS)

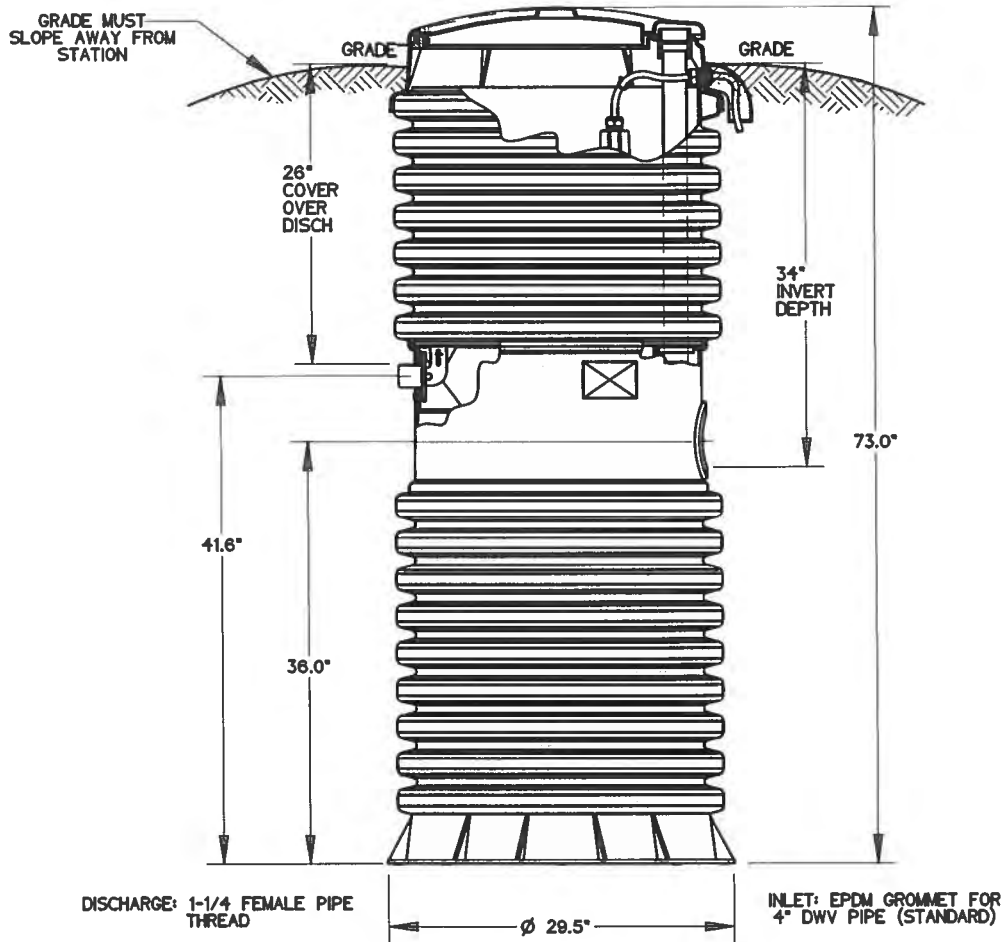

CONCRETE BALLAST MAY BE REQUIRED
SEE INSTALLATION INSTRUCTIONS
FOR DETAILS

NOTE: DIMENSIONS ARE FOR REF ONLY

AD	CAH	07/12/07	B	1/16
DR BY	CHK'D	DATE	ISSUE	SCALE
 SEWER SYSTEMS				
MODEL DH071-74 / DR071-74				
NA0050P05				

OPTIONS : **DH071-160** (HARD WIRED LEVEL CONTROLS)

DR071-160 (WIRELESS LEVEL CONTROLS)



GRADE MUST SLOPE AWAY FROM STATION

159.2"

112" COVER OVER DISCH

120" INVERT DEPTH

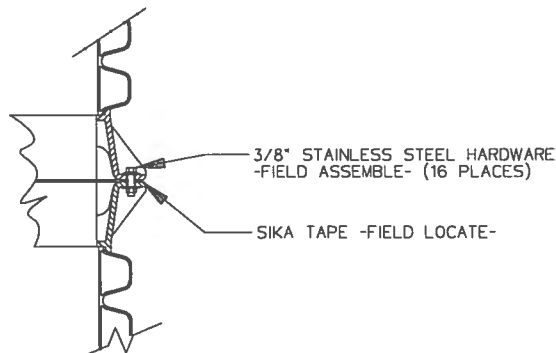

DETAIL, FIELD JOINT

SEE INSTALLATION INSTRUCTIONS FOR FURTHER DETAILS

CONCRETE BALLAST MAY BE REQUIRED
SEE INSTALLATION INSTRUCTIONS FOR DETAILS

NOTE: DIMENSIONS ARE FOR REF ONLY

41.6"

36.0"

DISCHARGE:
1-1/4 FEMALE
PIPE THREAD

Ø 29.5"

INLET:
EPDM GROMMET
FOR 4" DWV
PIPE (STANDARD)



AD	CAH	07/13/07	B	1/16
DR BY	CHK'D	DATE	ISSUE	SCALE



MODEL DH071-160 / DR071-160

NA0050P10

OPTIONS : **DH071-158** (HARD WIRED LEVEL CONTROLS)
 DR071-158 (WIRELESS LEVEL CONTROLS)

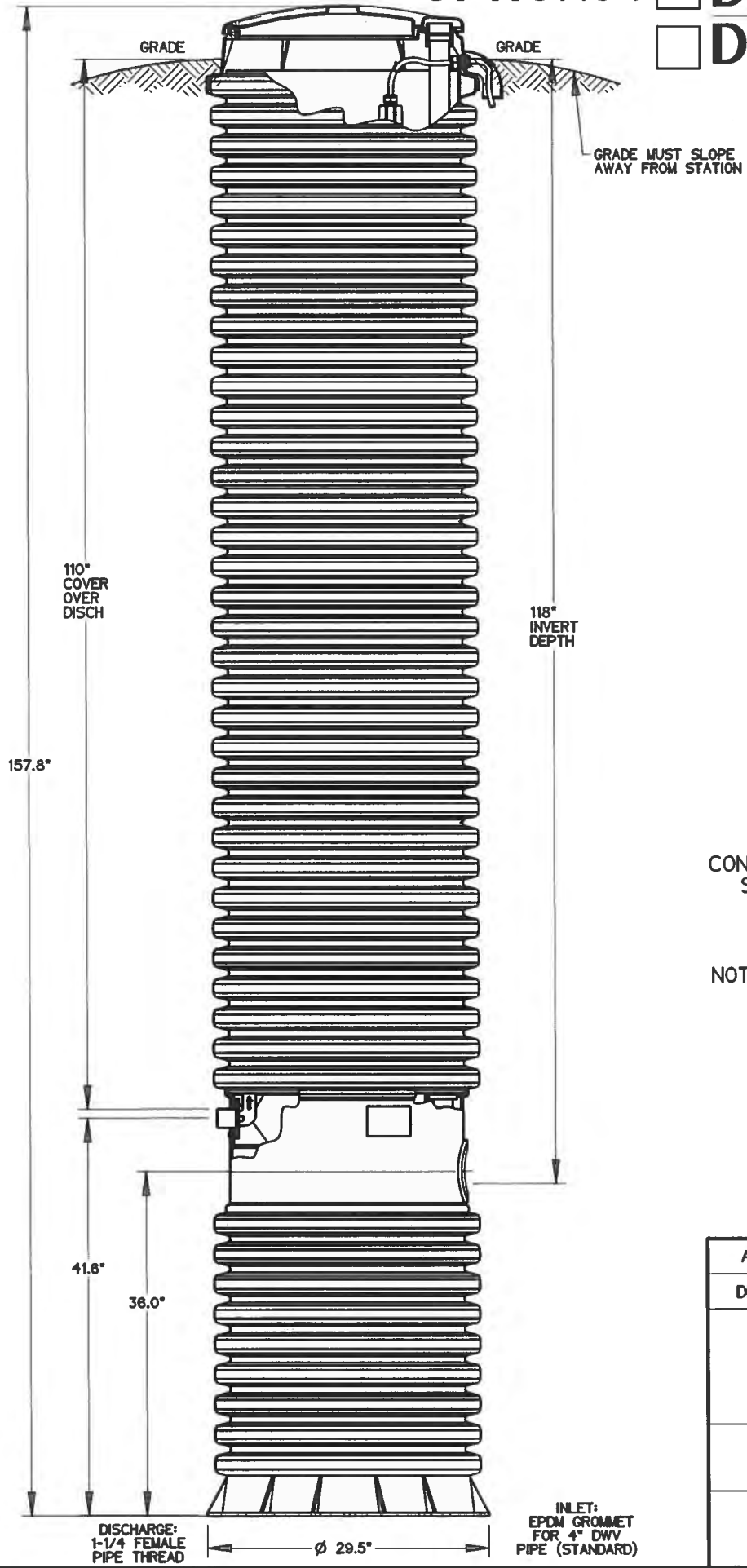

CONCRETE BALLAST MAY BE REQUIRED
 SEE INSTALLATION INSTRUCTIONS
 FOR DETAILS

NOTE: DIMENSIONS ARE FOR REF ONLY



AD	CAH	07/13/07	B	1/16
DR BY	CHK'D	DATE	ISSUE	SCALE



MODEL DH071-158 / DR071-158

NA0050P09

DISCHARGE:
 1-1/4 FEMALE
 PIPE THREAD

INLET:
 EPDM GROMMET
 FOR 4" DWV
 PIPE (STANDARD)

OPTIONS : **DH071-129**

(HARD WIRED
LEVEL CONTROLS)

DR071-129

(WIRELESS
LEVEL CONTROLS)

GRADE MUST SLOPE
AWAY FROM STATION

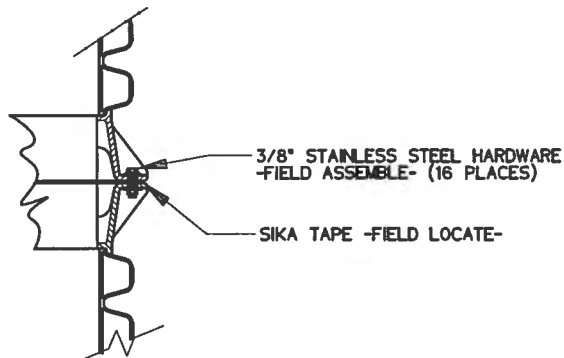
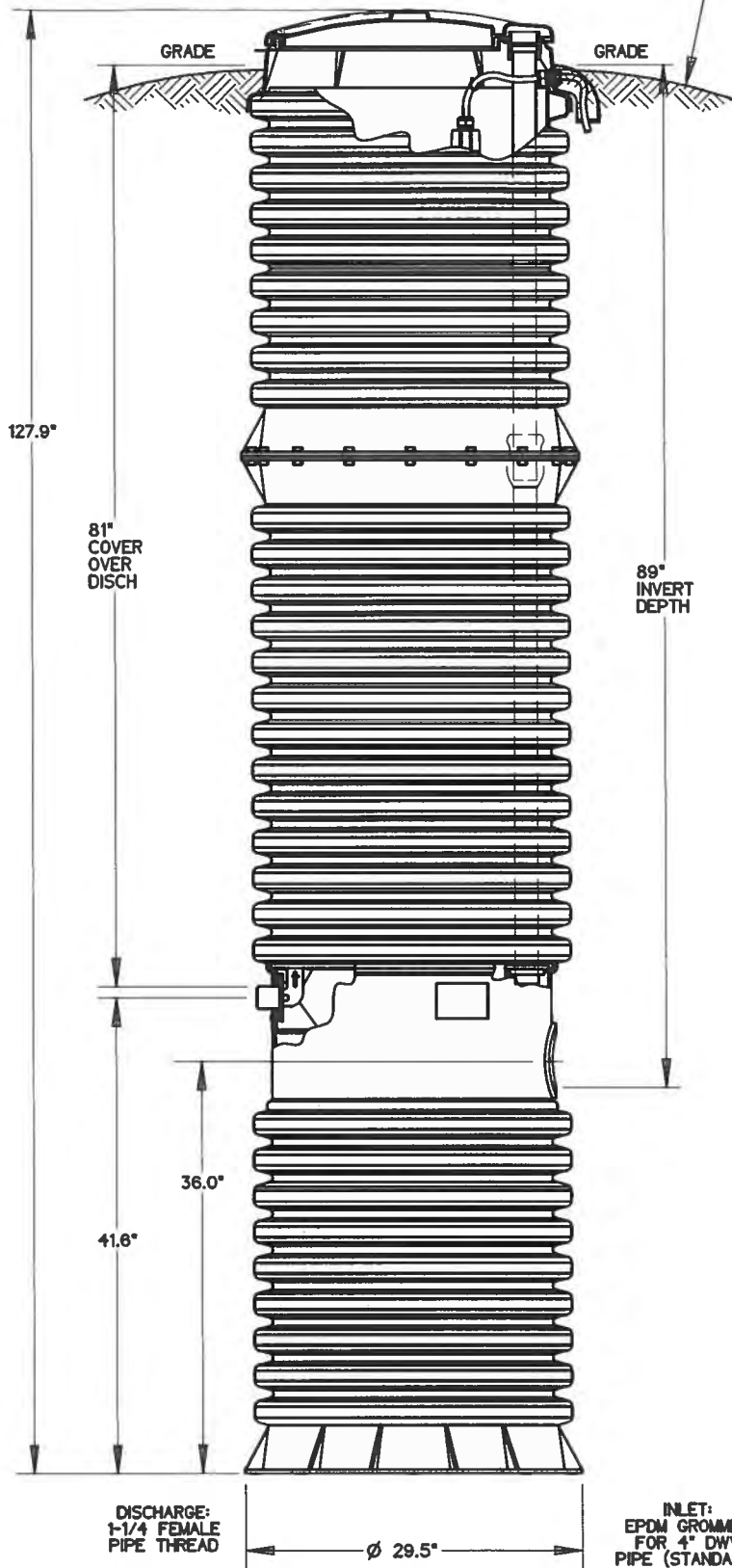

DETAIL, FIELD JOINT

SEE INSTALLATION INSTRUCTIONS
FOR FURTHER DETAILS

CONCRETE BALLAST MAY BE REQUIRED
SEE INSTALLATION INSTRUCTIONS
FOR DETAILS

NOTE: DIMENSIONS ARE FOR REF ONLY



AD	CAH	07/13/07	B	1/16
DR BY	CHK'D	DATE	ISSUE	SCALE

eone
SEWER SYSTEMS

MODEL DH071-129 / DR071-129

NA0050P08

OPTIONS : **DH071-124**

(HARD WIRED
LEVEL CONTROLS)

DR071-124

(WIRELESS
LEVEL CONTROLS)

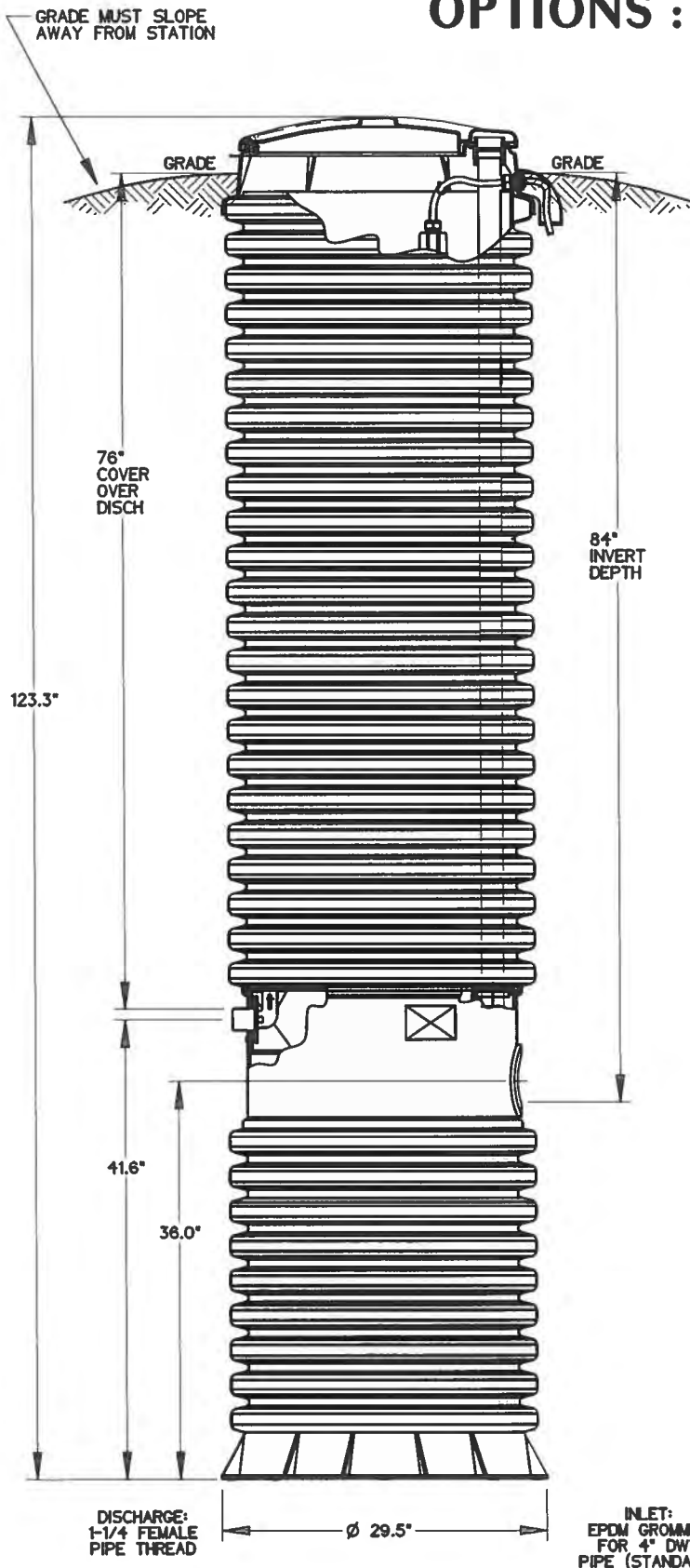

CONCRETE BALLAST MAY BE REQUIRED
SEE INSTALLATION INSTRUCTIONS
FOR DETAILS

NOTE: DIMENSIONS ARE FOR REF ONLY



AD	CAH	07/13/07	B	1/16
DR BY	CHK'D	DATE	ISSUE	SCALE



MODEL DH071-124 / DR071-124

NA0050P07

OPTIONS : **DH071-93**

(HARD WIRED
LEVEL CONTROLS)

DR071-93

(WIRELESS
LEVEL CONTROLS)

GRADE MUST SLOPE
AWAY FROM STATION

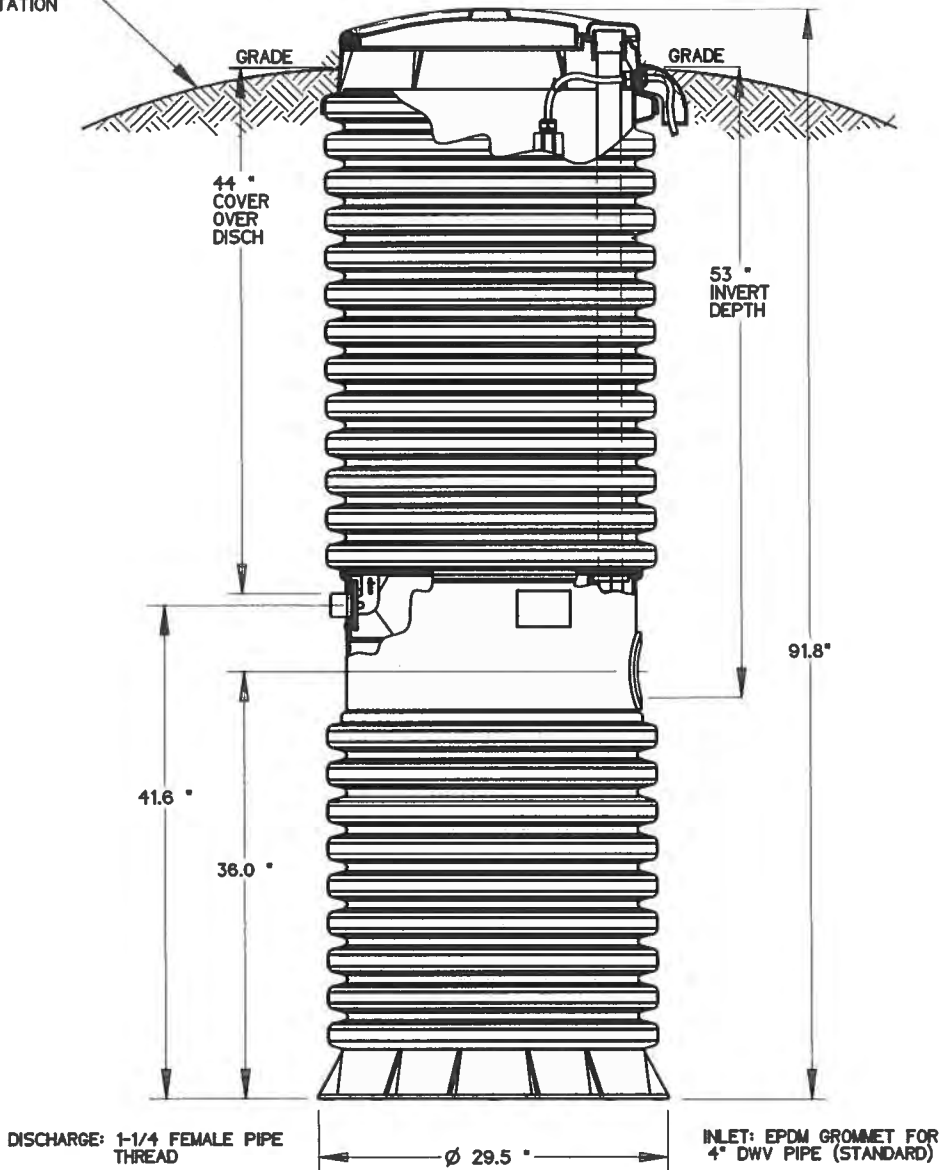

CONCRETE BALLAST MAY BE REQUIRED
SEE INSTALLATION INSTRUCTIONS
FOR DETAILS

NOTE: DIMENSIONS ARE FOR REF ONLY



AD	CAH	07/12/07	B	1/16
DR BY	CHK'D	DATE	ISSUE	SCALE

e one
SEWER SYSTEMS

MODEL DH071-93 / DR071-93

NA0050P06

LIBERTY PUMPS

Liberty Pumps®

2400-Series

Simplex Grinder Package

Factory Assembled
2 hp Grinder Pump
24" Diameter System

Features:

- Pre-mounted floats for pump control and alarm
- 4" Fiberglass hub with 4" rubber pipe seal
 - 1-1/4" Discharge
- Factory pre-assembled guide rail system
 - Integral check valve
- Galvanized guide rail pipe (stainless optional)
- Factory pre-assembled schedule 80 PVC discharge piping with ball valve
- Fiberglass basin with anti-flotation collar
- Structural foam cover - 1000 lb. load rating (steel optional)
 - All stainless steel supports and brackets pre-mounted
- NEMA 4X junction box for electrical connections, pre-mounted
- Stainless steel chain for pump lift-out
- Shipped standard with SX-Series control Panel. IP-Series Panel optional



4" inlet hub
with seal



Available
Heights

48"
60"
72"
84"



Available with
LSG or LSGX-Series
(2-Stage) Grinders



innovate. evolve.

2400-Series Specifications

Features:

2 hp. Grinder Pump
Choose from single stage LSG or two stage LSGX-Series pumps



- Available in a wide range of voltages
- 1-1/4" discharge
- 25' power cable length

(See LSG or LSGX-Series literature for complete pump specifications.)

Performance Curves:

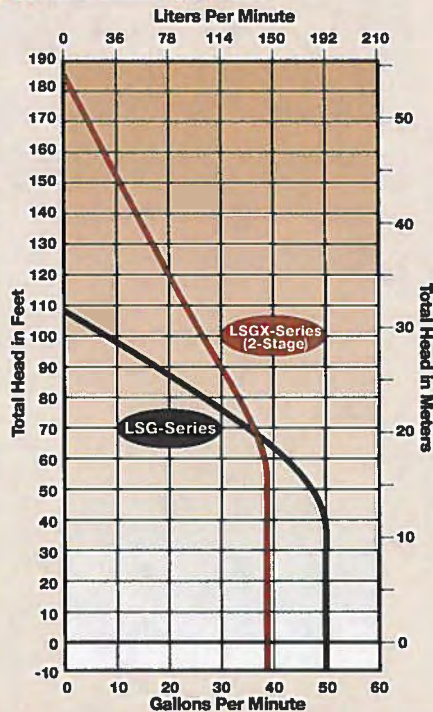

Dimensional Data

Top View

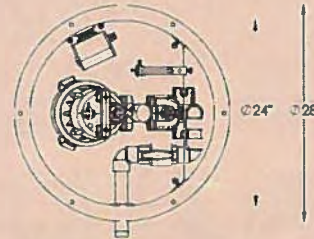

Side View

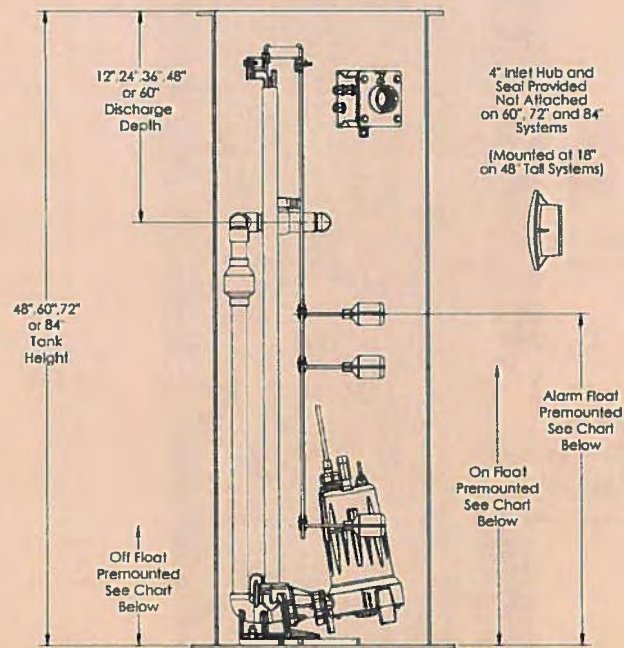

Floor levels are adjustable per included instructions

Galvanized guide rails standard. For stainless steel rails add "S" to model number. Example: 2472LSG24-S

For steel cover option add "-SC" suffix to model number. Example: (steel) 2472LSG24-SC

Factory set control levels 2400-Series

Model	Off level	On Level	Alarm Level	Volume per Pump Cycle	Total Basin Capacity
2448	9.5" (42 cm)	16.5" (41.9 cm)	21" (79 cm)	13.5 gal. (51 liters)	94 gal. (356 liters)
2460	13" (33 cm)	27" (69 cm)	33" (86 cm)	31 gal. (117 liters)	118 gal. (447 liters)
2472	13" (33 cm)	31" (79 cm)	37" (94 cm)	39 gal. (148 liters)	141 gal. (534 liters)
2484	13" (33 cm)	33" (84 cm)	37" (102 cm)	43 gal. (163 liters)	165 gal. (625 liters)

Specifications are subject to change without notice.



Liberty Pumps®

LSG200-Series



Omnivore®
Grinders

2 hp

1-1/4" Discharge

Features:

- New Patented V-Slice® cutter technology
- One-piece uni-body casting
- Stainless steel impeller
- Quick-disconnect power cord
- Internal or external capacitor models available
- 300 Series SS Rotor Shaft

Patent: See
www.libertypumps.com/patents

innovate. evolve.





Liberty's LSG200-Series Grinder Pumps meet the demanding needs of commercial and residential sewage applications where difficult solids-handling ability is crucial. The LSG200-Series features a superior cutting system made of hardened 440 stainless steel – Rockwell C 58, for shearing solids into small particles prior to being passed to the discharge by the impeller under high pressure. Applications include individual or groups of homes, motels, schools, shopping centers, lakefront developments and systems requiring high pressure sewage pumping.

LSG200-Series Grinder Pumps

Features:

- 2 hp, heavy-duty motor – oil filled, thermally protected
- Upper and lower ball bearings
- One-piece uni-body cast iron housing
- 300 Series SS Rotor Shaft
- 316 Stainless steel impeller
- Dual seals – Upper seal is unitized durable silicon carbide. Lower seal is Viton® double-lip. (Lower seal ensures that all debris is kept away from main seal)
- Motor windings insulated to Class B (130°C)
- Advanced V-Slice® cutting system made of hardened 440 stainless steel – Rockwell C 58
- Horizontal 1-1/4" FNPT Discharge
- Back vanes on impeller and spiraled bottom plate for superior solids clearing
- All stainless steel fasteners
- Clog-free volute design
- Designed for maximum heat dissipation and cool motor operating temperatures
- Solid state starting circuit - no mechanical relay coil
- 25' power cord with Quick-Disconnect
- Piggy back plug with wide angle float (on automatic model) eliminates need for expensive panel

Viton® is a registered trademark of DuPont Dow Elastomers LLC.

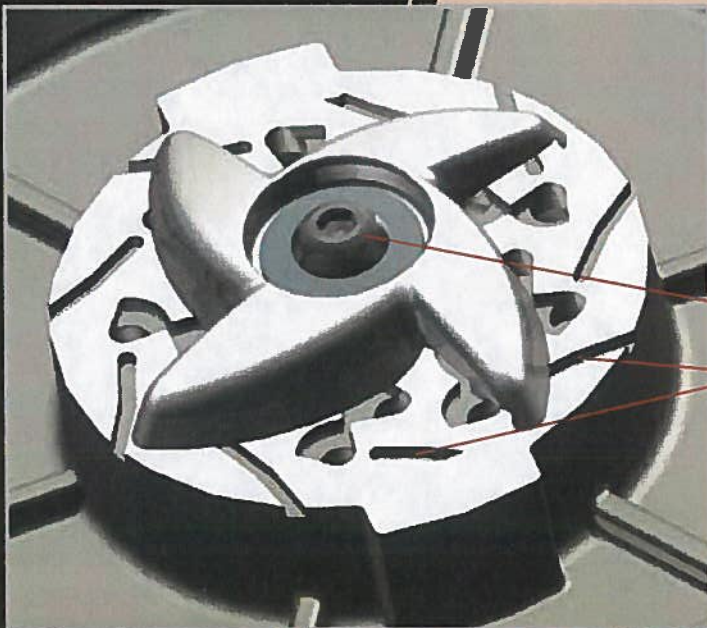

V-Slice® Technology

Superior cutting system provides improved shredding performance over radial cutters. V-pattern provides up to 108 alternated cuts per revolution. Entire cutting system made of 440 stainless steel hardened to 58Rc.

Recessed cutter bolt eliminates wadding

Exclusion cleanout slots and back relief clears debris from under cutter

Patent: See
www.libertypumps.com/patents

inno

Stainless steel clasp for lift-out chain

Large stainless steel handle with rubber grip

Quick-disconnect power cord

Dependable solid state starting circuit

Internal start/run capacitors on single phase models. "C" models have external caps and require a control panel

Thermal overload (single phase only)

2 hp motor

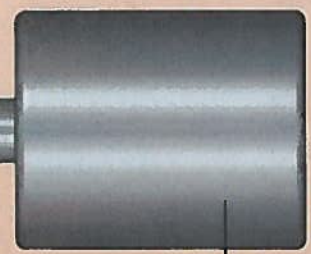

Wide angle float with piggy-back plug

Unique one-piece unibody casting

Silicon carbide upper seal

300 Series SS Rotor Shaft

316 SS impeller

Viton® double-lip lower seal

Robust motor plate

440 SS cutter plate spiraled for solids clearing

1-1/4" NPT Discharge

Improved clog-free volute design

440 SS rotary cutter hardened to 58Rc

vate. evolve.

LSG200-Series Specifications

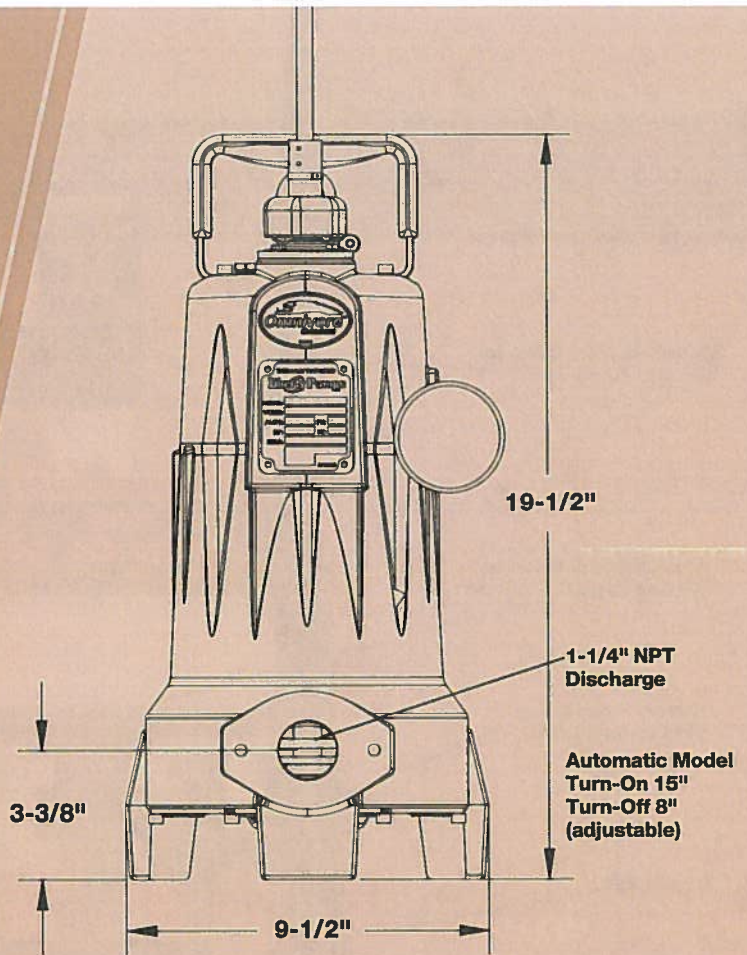
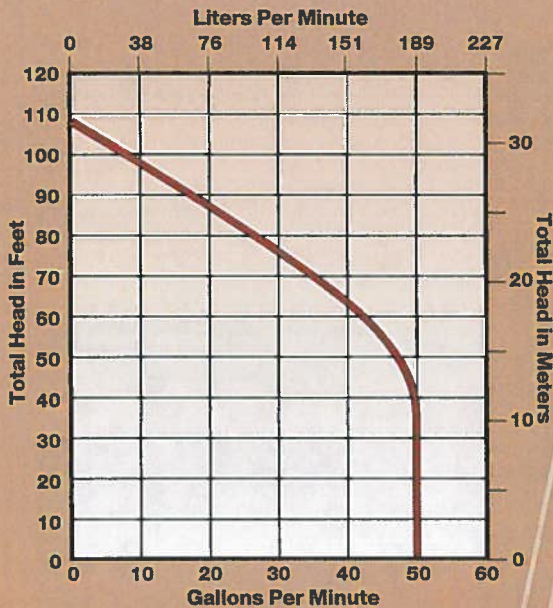

Model	HP	Volts	Phase	HZ	Amps	Locked Rotor Amps	Speed (RPM)	Discharge	Switch	Weight
LSG202A	2	208-230	1	60	15	53	3450	1-1/4"	Yes	86
LSG202M	2	208-230	1	60	15	53	3450	1-1/4"	No	84
LSG202M-C	2	208-230	1	60	15	53	3450	1-1/4"	No	84
LSG203M	2	208/230	3	60	10.6	62	3450	1-1/4"	No	84
LSG204M	2	440-480	3	60	5.3	31	3450	1-1/4"	No	84
LSG205M	2	575	3	60	4.9	31	3450	1-1/4"	No	84

Single phase models are thermally protected. 3-phase models require a properly sized control panel. Maximum fluid temperature 140° F

LSG202M and LSG202A feature internal capacitors and do not require a separate control panel for operation. LSG202M-C features external capacitors, requiring a panel with appropriately sized start and run capacitors.

Options for LSG202M-C: External Cap Grinder

Model	Description
K001316	Start/Run Capacitor Kit (for retrofit in existing panels)
SXHC24=3	Simplex NEMA 4X Panel with start/run capacitors
AE24HC=3	Duplex NEMA 4X Panel with start/run capacitors

For complete panel specifications, see SX or AE-series literature.
25' cord standard on all models. LSG202M-C features 35' cord standard.

GR20 Guide Rail Base (GR20 option sold separately)



- Cast Iron construction
- Single 1-1/4" guide rail pipe design
- Auto alignment feature (GR20 works only with LSG-Series pumps)
- Upper rail support bracket

www.libertypumps.com



Liberty Pumps • 7000 Apple Tree Avenue • Bergen, New York 14416
Phone 800-543-2550 Fax (585) 494-1839

Specifications are subject to change without notice. Copyright © Liberty Pumps, Inc. 2017 All rights reserved. LLIT3200 R03/17

Choice of Panel... SX-Series or IP-Series



SX-Series Panels - (Standard)

Provide reliable alternating operation with standard features that include:

- HOA Switch
- NEMA 4X enclosure
- Circuit Breaker
- Visual and Audible alarm
- Pump run indicator light
- Auxiliary contacts
- Three level control floats

For the complete SX-Series specifications, See SX-Series literature sheet.



IP-Series™ Panels - (Optional)

IP control panels incorporate the latest programmable pump features through a simple, easy-to-use touch pad on the inner door. Now pump programming and system monitoring is easier than ever.

Features:

- NEMA 4X weatherproof enclosure for indoor/outdoor mounting
- Float-less level sensor is compact and eliminates multiple wide-angle floats for controlling pump
- Redundant "ALARM" float included for added security
- Inner panel door provides increased safety
- Easy-to-use touch pad for programming pump on/off levels and alarm level in inches or centimeters
- Separate control and alarm fuses
- Digital display board for system monitoring
- Alarm beacon and horn provide audio/visual warning of alarm condition
- Test/Normal/Silence switch
- Auxiliary contacts
- Panel is field convertible for either demand dose or timed dose applications

For the complete IP-Series specifications, See IP-Series literature sheet.



NOTE: To order the IP-Series panel option, add "-IP" suffix to the system model number. Example: 2472LSG24-IP

vate. evolve.

2400- Series Simplex Models

24" diameter fiberglass basin available in heights of 48", 60", 72" and 84".

Available with standard SX-Series control panel or upgrade to the new IP-Series Intelligent Panel.

Systems listed to the right are shipped with a standard SX-Series control panel. To upgrade to an IP-Series panel add "-IP" suffix to the above model number. See SX-Series or IP-Series literature for complete specifications.

Models	Volts	Phase	Wgt.	Standard Panel SX-Series	(Optional) Panel IP-Series
2448 - 24" x 48" basin (Discharge depth is 12" from top of basin)					
2448LSG202	208/230	1	220 lbs.	ALM-2W	NA
2448LSG202-S	208/230	1	220 lbs.	ALM-2W	NA
2448LSG202-S-SC	208/230	1	230 lbs.	ALM-2W	NA
2448LSG202-SC	208/230	1	226 lbs.	ALM-2W	NA
2448LSGX202	208-230	1	229 lbs.	ALM-2W	NA
2448LSGX202-S	208-230	1	229 lbs.	ALM-2W	NA
2448LSGX202-S-SC	208-230	1	239 lbs.	ALM-2W	NA
2448LSGX202-SC	208-230	1	239 lbs.	ALM-2W	NA
2460 - 24" x 60" basin (Discharge depth is available in 24" or 36" from top of basin. Add -24 or -36 to model when ordering)					
2460LSG202 (-24 or -36)	208/230	1	230 lbs.	SXH24=3	IPS-24H
2460LSG202-A (-24 or -36)	208/230	1	231 lbs.	ALM-2W	NA
2460LSG202-C (-24, or -36)	208/230	1	231 lbs.	SXHC24=3	IPS-24HC
2460LSG203 (-24 or -36)	208/230	3	235 lbs.	SX34=3-511	IPS-34-511
2460LSG204 (-24 or -36)	440-480	3	235 lbs.	SX34=3-171	IPS-34-171
2460LSG205 (-24 or -36)	575	3	235 lbs.	SX54=3-161	IPS-54-161
2460LSGX202 (-24 or -36)	208-230	1	236 lbs.	SXH24=3	IPS-24H
2460LSGX202-C (-24 or -36)	208-230	1	237 lbs.	SXHC24=3	IPS-24HC
2460LSGX203 (-24 or -36)	208/230	3	242 lbs.	SX34=3-511	IPS-34-511
2460LSGX204 (-24 or -36)	440-480	3	242 lbs.	SX34=3-171	IPS-34-171
2460LSGX205 (-24 or -36)	575	3	242 lbs.	SX54=3-161	IPS-54-161
2472 - 24" x 72" basin (Discharge depth is available in 24", 36" or 48" from top of basin. Add -24, -36 or -48 to model when ordering)					
2472LSG202 (-24, -36 or -48)	208/230	1	237 lbs.	SXH24=3	IPS-24H
2472LSG202-C (-24, -36 or -48)	208/230	1	238 lbs.	SXHC24=3	IPS-24HC
2472LSG203 (-24, -36 or -48)	208/230	3	242 lbs.	SX34=3-511	IPS-34-511
2472LSG204 (-24, -36 or -48)	440-480	3	242 lbs.	SX34=3-171	IPS-34-171
2472LSG205 (-24, -36 or -48)	575	3	242 lbs.	SX54=3-161	IPS-54-161
2472LSGX202 (-24, -36 or -48)	208-230	1	243 lbs.	SXH24=3	IPS-24H
2472LSGX202-C (-24, -36 or -48)	208-230	1	244 lbs.	SXHC24=3	IPS-24HC
2472LSGX203 (-24, -36 or -48)	208/230	3	249 lbs.	SX34=3-511	IPS-34-511
2472LSGX204 (-24, -36 or -48)	440-480	3	249 lbs.	SX34=3-171	IPS-34-171
2472LSGX205 (-24, -36 or -48)	575	3	249 lbs.	SX54=3-161	IPS-54-161
2484 - 24" x 84" basin (Discharge depth is available in 24", 36", 48" or 60" from top of basin. Add -24, -36, -48 or -60 to model when ordering)					
2484LSG202 (-24, -36, -48 or -60)	208/230	1	258 lbs.	SXH24=3	IPS-24H
2484LSG202-C (-24, -36, -48 or -60)	208/230	1	265 lbs.	SXHC24=3	IPS-24HC
2484LSG203 (-24, -36, -48 or -60)	208/230	3	269 lbs.	SX34=3-511	IPS-34-511
2484LSG204 (-24, -36, -48 or -60)	440-480	3	269 lbs.	SX34=3-171	IPS-34-171
2484LSG205 (-24, -36, -48 or -60)	575	3	269 lbs.	SX54=3-161	IPS-54-161
2484LSGX202 (-24, -36, -48 or -60)	208-230	1	264 lbs.	SXH24=3	IPS-24H
2484LSGX202-C (-24, -36, -48 or -60)	208-230	1	265 lbs.	SXHC24=3	IPS-24HC
2484LSGX203 (-24, -36, -48 or -60)	208/230	3	270 lbs.	SX34=3-511	IPS-34-511
2484LSGX204 (-24, -36, -48 or -60)	440-480	3	270 lbs.	SX34=3-171	IPS-34-171
2484LSGX205 (-24, -36, -48 or -60)	575	3	270 lbs.	SX54=3-161	IPS-54-161

BARNES

Specifications:

inches
(mm)

- BASIN** Engineered Polypropylene Copolymer, 2-piece construction, factory assembled with preformed corrosion resistant rebar installed. Includes POD for pump support and orientation
- RISER**..... HDPE 18" Dia. (457mm) corrugated drainpipe, day-of-installation adjustment sets basin depth [limit 9ft. 6inches (2.9m) to bottom of basin]
- DISCHARGE OUTLET**..... 1-1/4" NPT Flexible, stainless steel. Connects to a basin mounted bronze tank receiver.
- INLET** 3 positions, 4" (Sch 40/80 or SDR35) Flexible Inlet Flange (For Field Installation)
- COVER** Rock-Shaped Polyethylene Cover, interlocking with Riser Adapter, vented or unvented. Keyed lock included.
Load rating of 150 lb per sq ft.
- ALARM BOX**..... Model 1500 Alarm Panel, NEMA 4X Non-metallic Enclosure with Keyed Lock, Alarm Light, Alarm Horn w/Push Button, Pump and Alarm Circuit Breakers
- DIRECT BURIAL CABLE** 12/5 Type TC, STOOV Round U.L. Listed. 30ft (9m) length standard
- MOVEABLE DISCHARGE FITTING w/ CHECK VALVE:** (Removed with Pump)
 - Housing*..... Powder Coated Cast Iron
 - Diaphragm*..... Fiber Reinforced Neoprene
 - Flapper* Fiber Reinforced Nitrile
 - Size*..... 1-1/4" Full Port
 - Valve Seat*..... Bronze
- BALL VALVE:** Toggle actuated via polypropylene harness from top side, removable without basin entry
 - Material*..... Bronze, with Stainless Steel ball & stem, and Teflon seats
 - Size*..... 1-1/4" Full Port
- LIFTING HARNESS** 1/8" x 3/4" Polypropylene (POD). 1/2" Dia. Polypropylene (PUMP) Breaking strength 3750 lbs.
- HARDWARE** 300 Series Stainless Steel
- LEVEL CONTROL** ESPS™ – Environmentally sealed pressure switch with CPVC housing, Nitrile diaphragm, Custom molded quick connect for sealing and strain relief.
- ANTI-SIPHON** Integral to cast iron motor housing.
 - Flapper*..... Fiber Reinforced Nitrile
 - Seat*..... Valox with stainless steel rivet
- PUMP** OGP2022CE (Std), 240 Volt, 1 Phase
- OPTIONS** Direct Burial Cable lengths, Rock Cover Vented or Flood Plain, Depth, OGVF2022CE Pump, Model 1550 Alarm Panel w/Generator Receptacle

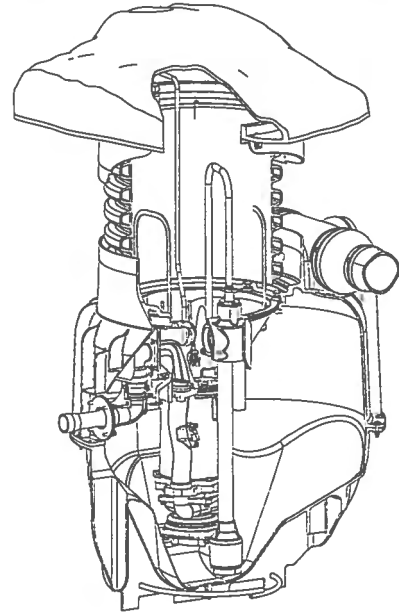

EcoTRAN™ System

For use with OGP and OGV pumps, 1 1/4" NPT

- Vented 52"-74" Depth
- Vented 76"-114" Depth
- Flood Plain 52"-74" Depth
- Flood Plain 76"-114" Depth

This product may be covered by one or more of the following patents and other patent(s) pending:
US Patent 7,357,341 & US Patent 7,578,657



LR16567
NSF 46



CERTIFIED TO
NSF / ANSI 46

BARNES[®]



LISTED BASIN ASSEMBLY E151564 2N87
UL1951

EcoTRAN™ System

<p>1. Depth</p> <p>52"-74" (1.3m-1.8m) Vented 76"-114" (1.9m-2.9m) Vented 52"-74" (1.3m-1.8m) Flood Plain 76"-114" (1.9m-2.9m) Flood Plain</p> <p>2. Pump Type (240V / 1 Phase)</p> <p>2 HP OGP2022CE (STD.) 2 HP OGVF2022CE</p> <p>3. Direct Burial Cable Length</p> <p>30 Feet (STD.) 50 Feet 100 Feet</p> <p>4. Rock Cover Options (Select One)</p> <p>Sandstone Flood Plain, Sandstone</p> <p>5. Alarm Box Options</p> <p>Model 1500 w/Alarm Light, Horn, Silence Button & Circuit Breaker Model 1550, includes 1500 features, Plus Generator Receptacle and Automatic Transfer Switch</p> <p>NOTES!</p> <ol style="list-style-type: none"> 1. Unit shipped boxed complete including Basin Package, Pump, Level Control and Alarm Box (Riser shipped separately). 2. Riser depth can be shortened in the field during installation. 3. All moving parts and seals serviceable from ground level without entry into the basin. 	
---	--

Model OGP2022CE

Recessed Vortex, Compact Series
For EcoTRAN System

Submersible Grinder Pumps

Specifications:

DISCHARGE	1¼", Bolt-on Moveable
LIQUID TEMPERATURE	104°F (40°C) Continuous
VOLUTE	Cast Iron ASTM A-48, Class 30
MOTOR HOUSING	Cast Iron ASTM A-48, Class 30
SEAL PLATE	Cast Iron ASTM A-48, Class 30
IMPELLERS: <i>Design</i>	12 Vane, Vortex, With Pump Out Vanes On Back Side. Dynamically Balanced, ISO G6.3.
<i>Material</i>	85-5-5-5 Bronze
IMPELLER SPACER.....	300 Series Stainless Steel
SHREDDING RING	Hardened 440C Stainless Steel Rockwell® C-55.
CUTTER	Hardened 440C Stainless Steel, Rockwell® C-55.
SHAFT	416 Stainless Steel
SQUARE RINGS	Buna-N
HARDWARE	300 Series Stainless Steel
PAINT	Air Dry Enamel.
SEAL: <i>Design</i>	Single Mechanical
<i>Material</i>	Rotating Faces - Silicon-Carbide Stationary Faces - Silicon-Carbide Elastomer - Buna-N Hardware -300 Series Stainless
CORD ENTRY.....	15 ft. (4.5m) Std. Cord. Custom Molded Quick Connect, for Sealing and Strain Relief (Supplied with station)
CORD <i>Automatic</i>	CSA/UL Approved 12/5 Type SOW
UPPER BEARING:	
<i>Design</i>	Single Row, Angular contact Ball
<i>Lubrication</i>	Oil
<i>Load</i>	Radial & Thrust
LOWER BEARING:	
<i>Design</i>	Single Row, Angular contact Ball
<i>Lubrication</i>	Oil
<i>Load</i>	Radial & Thrust
MOTOR: <i>Design</i>	NEMA L-Single Phase Torque Curve, Oil-Filled, Squirrel Cage Induction
<i>Insulation</i>	Class F
SINGLE PHASE.....	Capacitor Start/Capacitor Run
SUPPORT PLATE	Fiberglass
CHECK VALVE	
<i>Body</i>	Cast Iron ASTM A-48, Class 30
<i>Seat</i>	Bronze ASTM C836
<i>Flap</i>	Fiber Reinforced Buna
LEVEL CONTROL	SUPPLIED IN PACKAGE SYSTEM Model ESPS-150e, Environmentally sealed pressure switch with CPVC housing, Buna diaphragm, Custom molded quick connect for sealing and strain relief

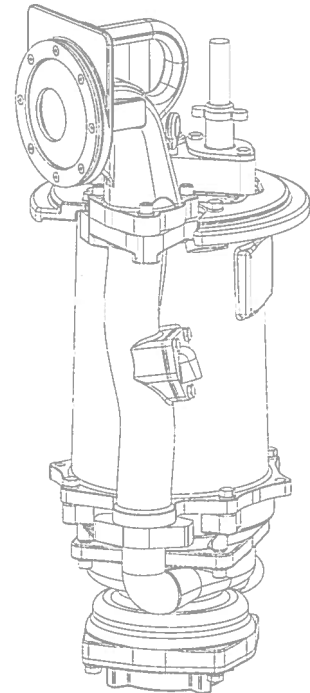

Series: OGP2022CE 2HP, 3450RPM, 60Hz

This product may be covered by one or more of the following patents and other patent(s) pending:
US Patent 7,357,341



CSA 108 - File No. LR16567,
UL 778

DESCRIPTION:

THE GRINDER PUMP IS DESIGNED TO REDUCE DOMESTIC SEWAGE TO A FINELY GROUND SLURRY.

Model OGP2022CE

Recessed Vortex
For Automatic Level Control



www.cranepumps.com

Submersible Grinder Pumps

inches
(mm)

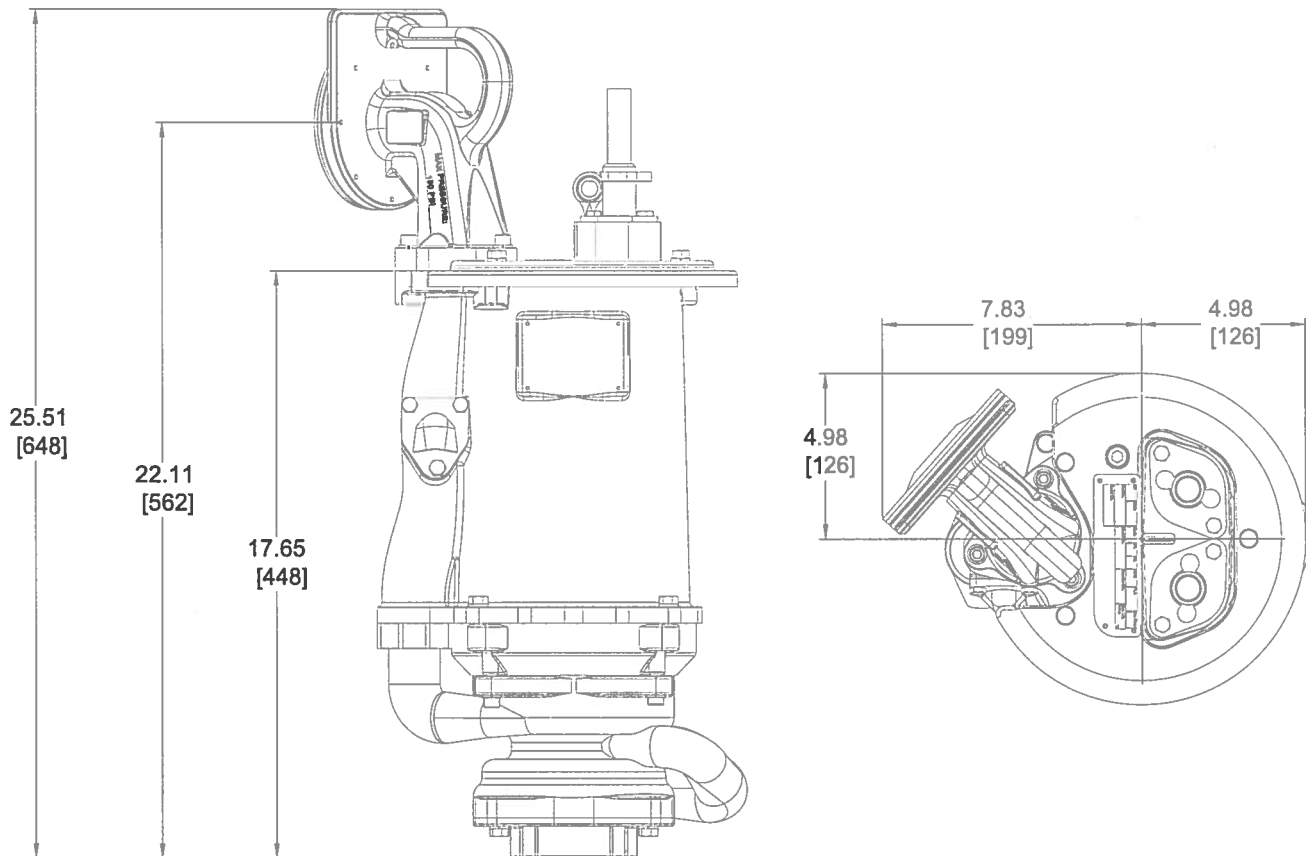

MODEL NO	PART NO	HP	VOLT/PH	Hz	RPM (Nom)	NEMA START CODE	FULL LOAD AMPS	LOCKED ROTOR AMPS	CORD SIZE	CORD TYPE	CORD O.D. ± .02 (.5) in (mm)
OGP2022CE *	119969	2	240/1	60	3450	H	16.5	53.8	12/5	SOW	.71 (18)

(* ESPS Level Control Supplied in Package System)

IMPORTANT !

- 1.) PUMP MAY BE OPERATED "DRY" FOR EXTENDED PERIODS WITHOUT DAMAGE TO MOTOR AND/OR SEALS.
- 2.) THIS PUMP IS APPROPRIATE FOR THOSE APPLICATIONS SPECIFIED AS CLASS I DIVISION II HAZARDOUS LOCATIONS.
- 3.) THIS PUMP IS NOT APPROPRIATE FOR THOSE APPLICATIONS SPECIFIED AS CLASS I DIVISION I HAZARDOUS LOCATIONS.
- 4.) INSTALLATIONS SUCH AS DECORATIVE FOUNTAINS OR WATER FEATURES PROVIDED FOR VISUAL ENJOYMENT MUST BE INSTALLED IN ACCORDANCE WITH THE NATIONAL ELECTRIC CODE ANSI/NFPA 70 AND/OR THE AUTHORITY HAVING JURISDICTION. THIS PUMP IS NOT INTENDED FOR USE IN SWIMMING POOLS, RECREATIONAL WATER PARKS, OR INSTALLATIONS IN WHICH HUMAN CONTACT WITH PUMPED MEDIA IS A COMMON OCCURRENCE.

SECTION A
PAGE 6
DATE 12/08



A Crane Co. Company

PUMPS & SYSTEMS

USA: (937) 778-8947 • Canada: (905) 457-6223 • International: (937) 615-3598

Model OGP2022CE

Performance Curve
 2HP, 3450RPM, 60Hz

Submersible Grinder Pumps



Performance curve includes impact of integral anti-siphon and check valve.
 Testing is performed with water, specific gravity 1.0 @ 68° F @ (20°C), other fluids may vary performance.

Specifications:

Listed by Underwriters Laboratories, simplex pump alarm panel used with the EcoTRAN System, UltraCAP² Basin Packages, or any other station using a pump with a automatic level control.

Model 1500 P/N: 116742

- 90 db Alarm Horn with pushbutton silence
- High Water Alarm Light
- 25 Amp pump circuit breaker and 10 Amp alarm circuit breaker
- NEMA 4X Enclosure
- Non-Metallic Enclosure
- Padlockable latch(s)
- 240 Volt single phase service

Model 1550 P/N: 111666

Includes the same base standard features as the 1500 series
Also Includes:

- Generator receptacle with automatic transfer switch
- NEMA code L14-30P Flanged Locking Receptacle
- 125/250 Volt, 3 Pole, 4 Wire
- 25 Amp pump circuit breaker and 3 Amp alarm circuit breaker

OPTIONAL EQUIPMENT..... 30 Ft. Generator Connection Cord, 12/4 SOW cord with NEMA L14-30R Locking Connector, Factory Installed and Tested P/N: 119962XC

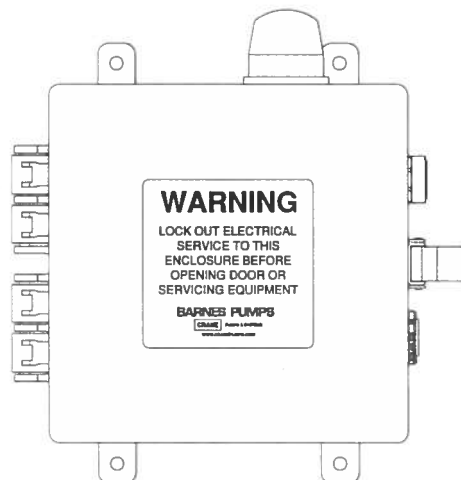
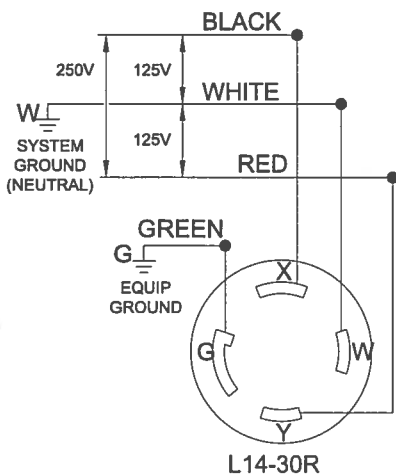

Model: 1500
Alarm/Disconnect Panel:
P/N: 116742

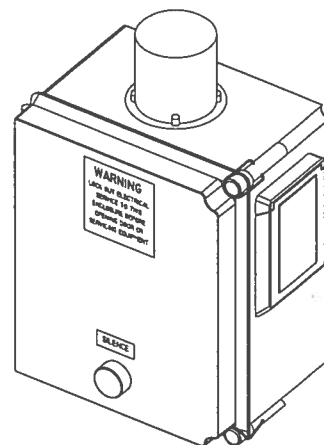

Model: 1550
Alarm/Disconnect Panel with
Generator Receptacle:
P/N: 111666



Model: 1500
File No. E241592
Model: 1550
File No. LR142177

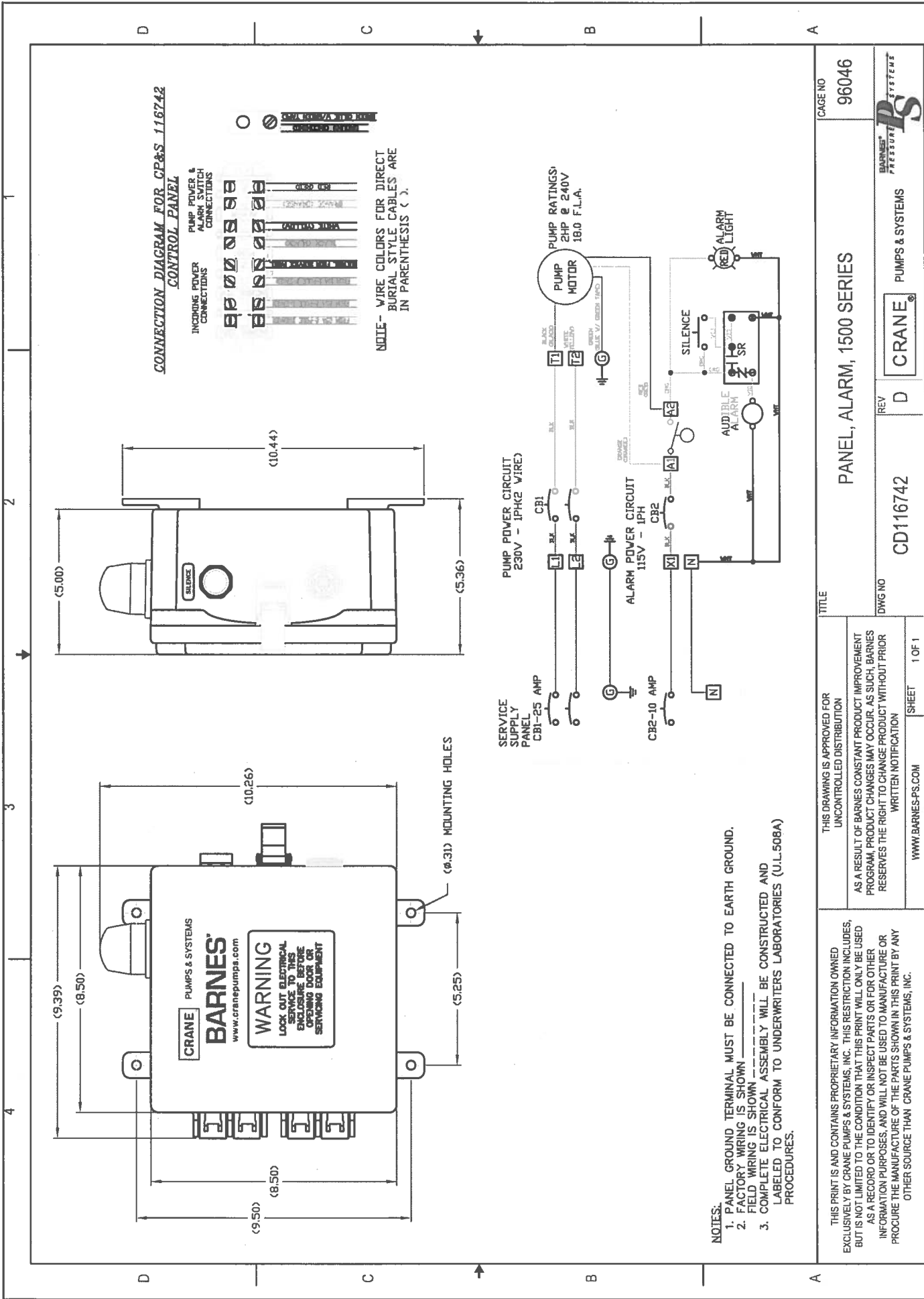

CONNECTION DIAGRAM FOR CR&S 116742 CONTROL PANEL

INDICING POWER CONNECTIONS
PUMP POWER & ALARM SWITCH CONNECTIONS

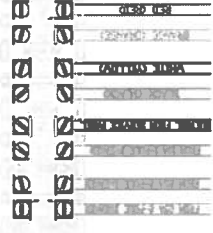

NOTE - WIRE COLORS FOR DIRECT BURIAL STYLE CABLES ARE IN PARENTHESIS ().

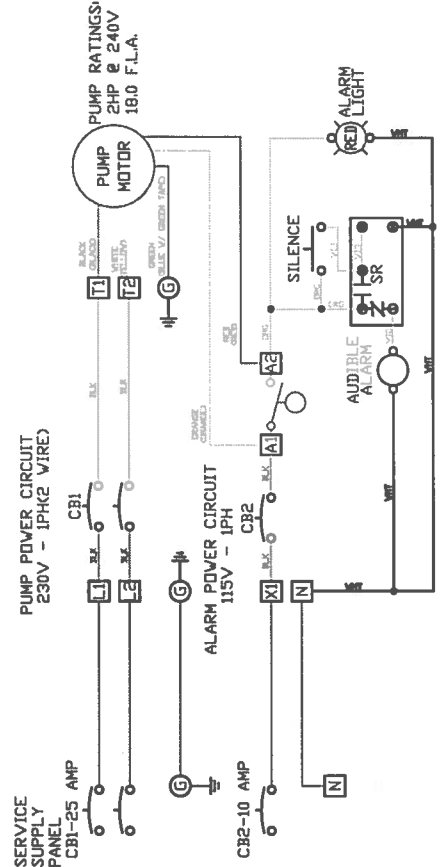

- NOTES:
1. PANEL GROUND TERMINAL MUST BE CONNECTED TO EARTH GROUND.
 2. FACTORY WIRING IS SHOWN _____
 3. COMPLETE ELECTRICAL ASSEMBLY WILL BE CONSTRUCTED AND LABELED TO CONFORM TO UNDERWRITERS LABORATORIES (U.L.508A) PROCEDURES.

THIS PRINT IS AND CONTAINS PROPRIETARY INFORMATION OWNED EXCLUSIVELY BY CRANE PUMPS & SYSTEMS, INC. THIS RESTRICTION INCLUDES, BUT IS NOT LIMITED TO THE CONDITION THAT THIS PRINT WILL ONLY BE USED AS A RECORD OR TO IDENTIFY OR INSPECT PARTS OR FOR OTHER INFORMATION PURPOSES, AND WILL NOT BE USED TO MANUFACTURE OR PROCURE THE MANUFACTURE OF THE PARTS SHOWN IN THIS PRINT BY ANY OTHER SOURCE THAN CRANE PUMPS & SYSTEMS, INC.		THIS DRAWING IS APPROVED FOR UNCONTROLLED DISTRIBUTION		TITLE	CAGE NO
AS A RESULT OF BARNES CONSTANT PRODUCT IMPROVEMENT PROGRAM, PRODUCT CHANGES MAY OCCUR. AS SUCH, BARNES RESERVES THE RIGHT TO CHANGE PRODUCT WITHOUT PRIOR WRITTEN NOTIFICATION		WWW.BARNES-PS.COM		PANEL, ALARM, 1500 SERIES	96046
SHEET 1 OF 1		DWG NO		REV	
		CD116742		D	
		CRANE		PUMPS & SYSTEMS	

1 2 3 4 5 6 7 8

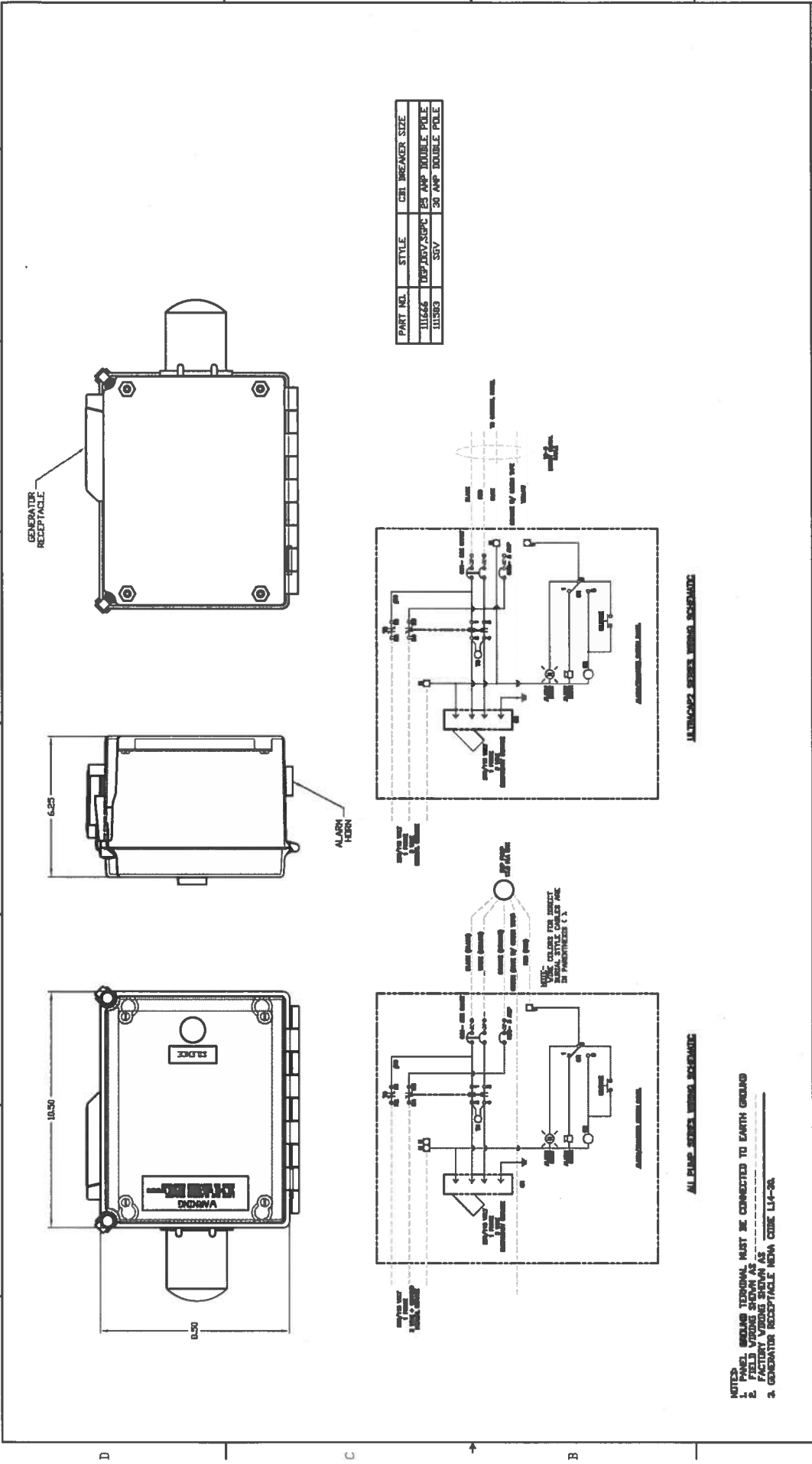

NOTES

1. PANEL WIRING TERMINAL MUST BE CONNECTED TO EARTH GROUND
2. FIELD WIRING SHOWN AS WIRING TO BE INSTALLED
3. GENERATOR RECEPTACLE NOW CODE L14-20

THIS PRINT IS AND CONTAINS PROPRIETARY INFORMATION OWNED EXCLUSIVELY BY CRANE PUMPS & SYSTEMS, INC. THIS RESTRICTION INCLUDES, BUT IS NOT LIMITED TO THE CONDITION THAT THIS PRINT WILL ONLY BE USED AS A RECORD OR TO IDENTIFY OR INSPECT PARTS OR FOR OTHER INFORMATION PURPOSES, AND WILL NOT BE USED TO MANUFACTURE OR PROCURE THE MANUFACTURE OF THE PARTS SHOWN IN THIS PRINT BY ANY OTHER SOURCE THAN CRANE PUMPS & SYSTEMS, INC.

WWW.BARNES-PS.COM SHEET 1 OF 1

THIS DRAWING IS APPROVED FOR UNCONTROLLED DISTRIBUTION AS A RESULT OF BARNES CONSTANT PRODUCT IMPROVEMENT PROGRAM. PRODUCT CHANGES MAY OCCUR. AS SUCH, BARNES RESERVES THE RIGHT TO CHANGE PRODUCT WITHOUT PRIOR WRITTEN NOTIFICATION

TITLE: PANEL, ALARM MODEL AU1550

DWG NO: CD111666

REV: C

CAGE NO: 96046

CRANE® PUMPS & SYSTEMS

BARNES PRESSURE SYSTEMS

Specifications:

HOUSING.....Chlorinated Polyvinyl Chloride (CPVC)
DIAPHRAGMS.....Buna N
TEMPERATURE RATING.....140°F (60°C) Continuous
PRESSURE SWITCH.....Snap Acting Diaphragm
SWITCH RATING:
Automatic.....18A @ 240 Volt AC, 1 Phase
THERMAL CUTOUT:
SWITCH.....Bimetallic, Snap Acting, Auto-Reset
MOUNTING.....In Conjunction with the EcoTRAN POD
SIMPLEX AUTOMATIC:
Two Switches.....On/Off, High Water Alarm, Solid State Relay

CORD.....Type SOW - 8 ft. (2.4m), 15 ft. (4.6m),
Automatic.....14/5

DESCRIPTION:

Diaphragm pressure switches, hermetically sealed within a protective CPVC casing. Thermal protection provided by automatic resetting, heat-sensing thermal cutout switch. Pressure Switches terminate into Barnes ® exclusive custom molded quick connector plug for sealing and strain relief.

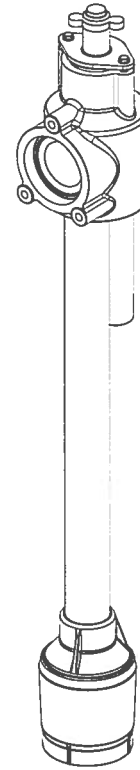

ESPS Level Controls

ESPS-150e

P/N: 119068

This product may be covered by one or more of the following patents and other patent(s) pending:
 US Patent 7,578,657



PATENT PENDING



File No. E242537

Level Controls

ESPS-150e

For use in EcoTRAN System

BARNES' PRESSURE SYSTEMS



www.cranepumps.com

Accessories

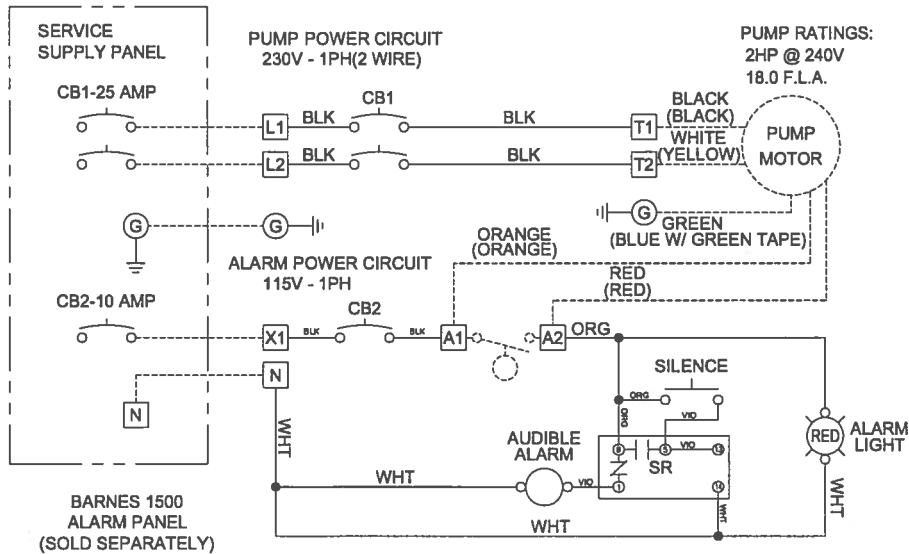
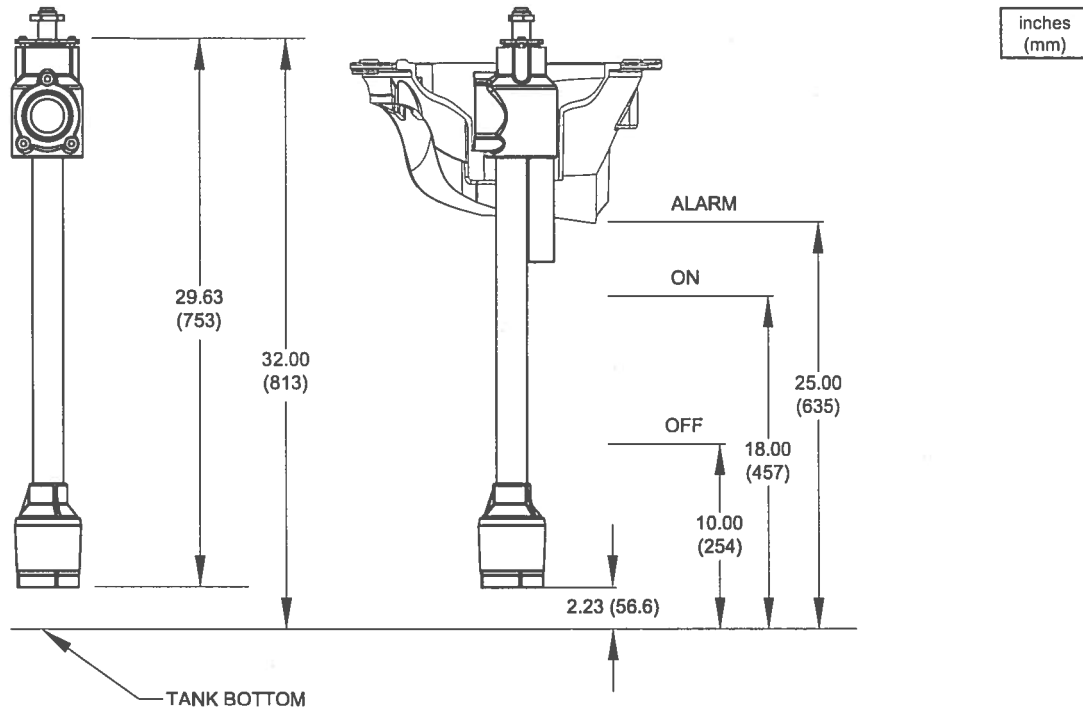

**EcoTRAN
WIRING DIAGRAM**

MODEL NUMBER	DESCRIPTION	PART NUMBER	CONTACTS	CABLE
ESPS-150e	Automatic	119068-M	Normally Open	14/5 SOW

SECTION F
PAGE 24B
DATE 1/06

CRANE

A Crane Co. Company

PUMPS & SYSTEMS

USA: (937) 778-8947 • Canada: (905) 457-6223 • International: (937) 615-3598

